

# PI31xx-xx-EVAL1 Cool-Power® ZVS Isolated DC-DC Converter Evaluation Board

Chris Swartz  
Principal Applications Engineer  
May 2013



Contents	Page	Introduction
<i>Introduction</i>	1	The PI31xx-xx-EVAL1 evaluation board allows the user to test the basic operating principles of the PI31xx series of high density DC-DC power converters and experience the performance and value of this solution compared to alternate conventional solutions. Each evaluation board is populated with the components that could be used in a final design. It is not designed or intended to be used in end product applications. Please read this document prior to the connection of test equipment and refer to the product datasheet for device specifications, descriptions and characteristics. Remember to follow good lab safety practices and use safety glasses at all times.
<i>Product Description</i>	2	
<i>Board Connections</i>	2	
<i>Thermal Considerations</i>	3	
<i>Max I/O Ratings</i>	5	The PI31xx-xx-EVAL1 is configured to support one single input and one single output. Each board offers pin strap options for trimming the output voltage up and down, turning the converter on and off and adding EMI system “Y” capacitors. Additional parts are included to compensate for line impedance associated with long leads from the bench power supply to the converter. Additional component footprints are made available to allow the user to test different design configurations that may be required to meet their end needs. Kelvin type test points are included to allow for easy and convenient connections of testing instruments for evaluation of efficiency, line/load regulation and transient response. A low impedance oscilloscope connection using a Johnson jack is included for ripple measurement and evaluation of the output voltage during transient events. Each demo board is equipped with a heatsink to allow high power operation with a small amount of air flow and to allow operation of the board over various temperature extremes.
<i>Schematic</i>	6	
<i>BOMs</i>	11	
<i>Test Setup</i>	12	
<i>PCB Artwork</i>	14	
<i>Mechanical Outline</i>	14	
<i>Ordering Information</i>	14	

Figure 1.  
PI31xx-xx-EVAL1  
Evaluation Board

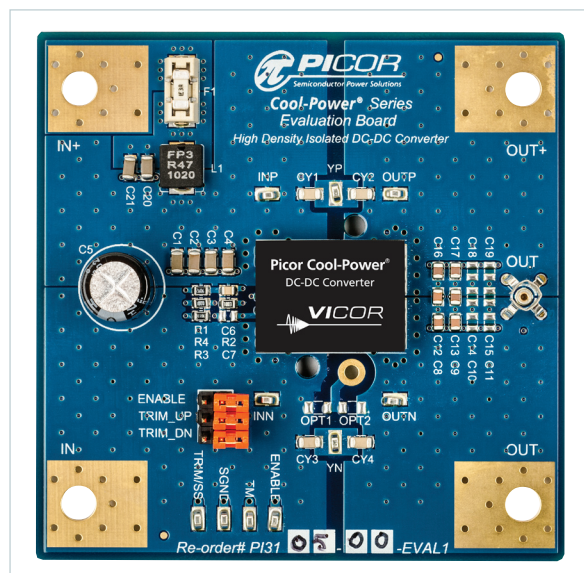

---

## Cool-Power® PI31xx Series Product Description

The PI31xx operates over a wide range input, delivering 50 W or 60 W output power depending on the individual model number. The PI31xx Series is available in a space saving surface mountable 0.87" x 0.65" x 0.265" Power –System –in – a – Package (PSiP), achieving ~50% space reduction versus alternative solutions.

The switching frequency of 900kHz allows for small input and output filter components which further reduces the total size and cost of the overall system solution. The output voltage is sensed and fed back to the internal controller using a proprietary isolated magnetic feedback scheme which allows for high bandwidth and good common mode noise immunity.

The PI31xx Series requires no external feedback compensation and offers a total solution with a minimum number of external components. A rich feature set is offered, including + 10%, -20% output voltage trim capability (depending on the model number), remote enable, over-voltage protection, adjustable soft-start, over-current protection with auto-restart to protect against both short circuit and overload and over and under input voltage lockout. A unique temperature monitor and protection circuit is included that provides an analog voltage proportional to the internal die temperature, as well as over temperature shutdown, restart and over temperature fault alarm signal.

### Board Connections

#### 1. Connect Test Equipment

- a. Connect the input DC power supply to the target board as shown in Figure 6. The negative terminal should be wired to –IN and the positive terminal should connect to the positive terminal of the DMM wired as a DC Ammeter. Be sure that the proper sized wires are used to allow minimum voltage drop for a maximum input current of up to 4 A. Use ring lugs mated to the included fasteners on the evaluation board. If your input power supply has remote sense capability, it can be wired to the INN and INP test points if desired. Connect the positive terminal of the DMM to the +IN lug on the evaluation board.
- b. Connect the primary side DMM (for measuring the input voltage) to INN and INP respectively.
- c. Connect the oscilloscope as shown in Figure 6 if you are planning to measure both primary and secondary signals at the same time. If you do not have an isolated differential amplifier, it is important to note that simultaneous measurement of both primary and secondary referenced signals using an oscilloscope with a grounded chassis is not recommended, as it will short circuit the primary to secondary isolation barrier. Floating the oscilloscope is also not recommended due to the large capacitance introduced by this long standing practice. The best practice is to use an isolated differential amplifier or use an oscilloscope with isolated channels. That is, the input returns are isolated from each other and earth ground.
- d. Connect the output DC DMM to the test points OUTN and OUTP. These test points are done in a Kelvin type manner so that they have no high current flowing in them.
- e. Connect the DC Load to the output lugs OUT+ and OUT-. It is critical for this connection to be low inductance.

## 2. Default Pin Strap Configuration

- a. Ensure the pin straps are in the following default locations before proceeding:
  - ENABLE = Not Used (enabled)
  - TRIM\_UP = Not Used
  - TRIM\_DN = Not Used
  - OPT1 = Not Used
  - OPT2 = Not Used

## 3. Pin Strap Functions

- a. ENABLE – adding a strap on this pin will cause the converter to shut down.
- b. TRIM\_UP – Adding a strap in this location will adjust the output voltage up by 10%.
- c. TRIM\_DN – Adding a strap in this location will adjust the output voltage down by 10%. Only one strap can be connected at a time. If both trim straps are out, the output voltage should be set to the model's nominal output.

## 4. Trimming And Soft Start

- a. For those customers who wish to trim to another voltage by changing the preset trim resistors to another value, the trim equation shown in Figure 2 can be used:

Figure 2.  
PI31xx Trim Equation

$$R_{low} = (-V_{desired}) \cdot \frac{R_{INT}}{(-V_{out_{nom}}) + V_{desired}}$$

$$R_{high} = (-RSS) \cdot \frac{(-V_{out_{nom}}) \cdot V_{ERO} + V_{desired} \cdot V_{ref}}{V_{ref} [(-V_{out_{nom}}) + V_{desired}]}$$

Where:  $R1 = R_{low}$   $R3 = R_{high}$   $V_{ERO} = 4.9$  and  $V_{ref}$  can be found in the appropriate model datasheet.

Figure 3 shows an equation for soft start configuration where  $C7 = C_{REF}$

Figure 3.  
PI31xx Soft Start Equation

$$C_{REF} = \frac{T_{ssdesired} - 230 \cdot 10^{-6}}{23000}$$

Figure 4.  
PI31xx Trimming Equivalent Circuit

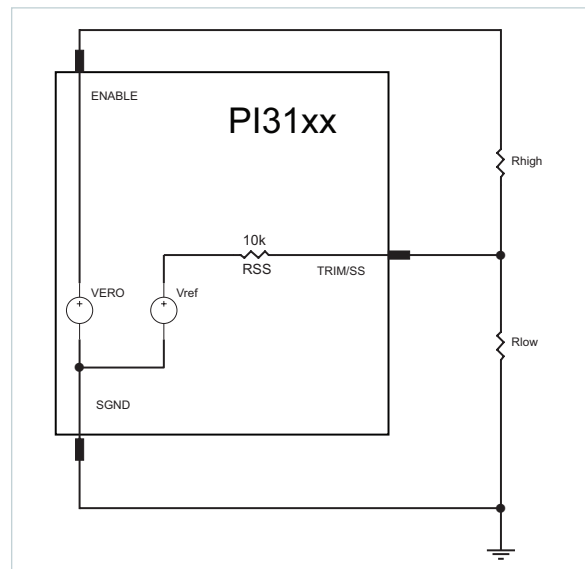

## Thermal Considerations

The PI31xx-xx-EVAL1 is supplied with optional heat sinks. At present, Picor offers four different heat sink options to accommodate the customers space and cooling needs. Heatsinks are available in two sizes, one with 6.3mm fins and the other with 11mm fins. Each of those heatsinks can be ordered with a specific air flow direction in mind, both cross flow and longitudinal are supported. Please refer to the product website [www.vicorpower.com](http://www.vicorpower.com) for more information.

Table 1.  
PI31xx-xx-EVAL1  
Input-Output Pin Description

Pin Name	Type	Description
IN+	Input/Lug	Primary side positive input voltage terminal.
IN-	Input/Lug	Primary side negative input voltage terminal.
OUT+	Output/Lug	Isolated secondary DC output voltage positive terminal.
OUT-	Output/Lug	Isolated secondary DC output voltage negative terminal.
TM	Test/Pin	Temperature measurement output pin with respect to SGND. $3V=300^{\circ}K$ 10mV/ $^{\circ}K$
SGND	Test/Pin	Signal ground, primary side referenced.
TRIM/SS	Test/Pin	Monitor pin for the soft start voltage and trim voltage reference with respect to SGND.
ENABLE	Test/Pin	Allows for monitoring of the ENABLE signal with respect to SGND.
INN	Test/Pin	Kelvin sense connection for input supply (-) and input voltage measurement test point.
INP	Test/Pin	Kelvin sense connection for input supply (+) and input voltage measurement test point.
YN	Output/Pad	Optional test pad for connection of optional "YN" capacitor to external system ground.
YP	Output/Pad	Optional test pad for connection of optional "YP" capacitor to external system ground.
OUTP	Test/Pin	Kelvin sense connection for output voltage (+) and output voltage measurement test point.
OUTN	Test/Pin	Kelvin sense connection for output voltage (-) and output voltage measurement test point.
OUT	Test/Pin	PCB test jack for low noise measurement of the output voltage.

Table 2.  
PI31xx-xx-EVAL1  
Evaluation Board  
Pin Strap and Jumper  
Description

Name	Description
ENABLE	If strap is installed, unit is turned off. If strap is removed, unit will be enabled.
TRIM_UP	If strap is installed, PI3105 trims output voltage up 10%
TRIM_DN	If strap is installed, PI3105 trims output voltage down 10%
OPT1	Allows optional connection of heat sink assembly to secondary return (-IN)
OPT2	Allows optional connection of heat sink assembly to secondary return (-OUT)

Table 3.  
 PI31xx-xx-EVAL1  
 Evaluation Board  
 Maximum I/O Ratings

Name	Max Voltage	Max Current
IN+	100 V	20 A
IN-	100 V	20 A
OUT+	20 V	20 A
OUT-	20 V	20 A
TRIM_DN	10 V	100 mA
OPT1	10 V	100 mA
OPT2	10 V	100 mA
OUT	10 V	100 mA
INP	10 V	100 mA
INN	10 V	100 mA
ENABLE	10 V	100 mA
TRIM/SS	10 V	100 mA
SGND	10 V	100 mA
TM	10 V	100 mA
OUTP	20 V	100 mA
OUTN	20 V	100 mA

Figure 5.  
Schematic Diagram

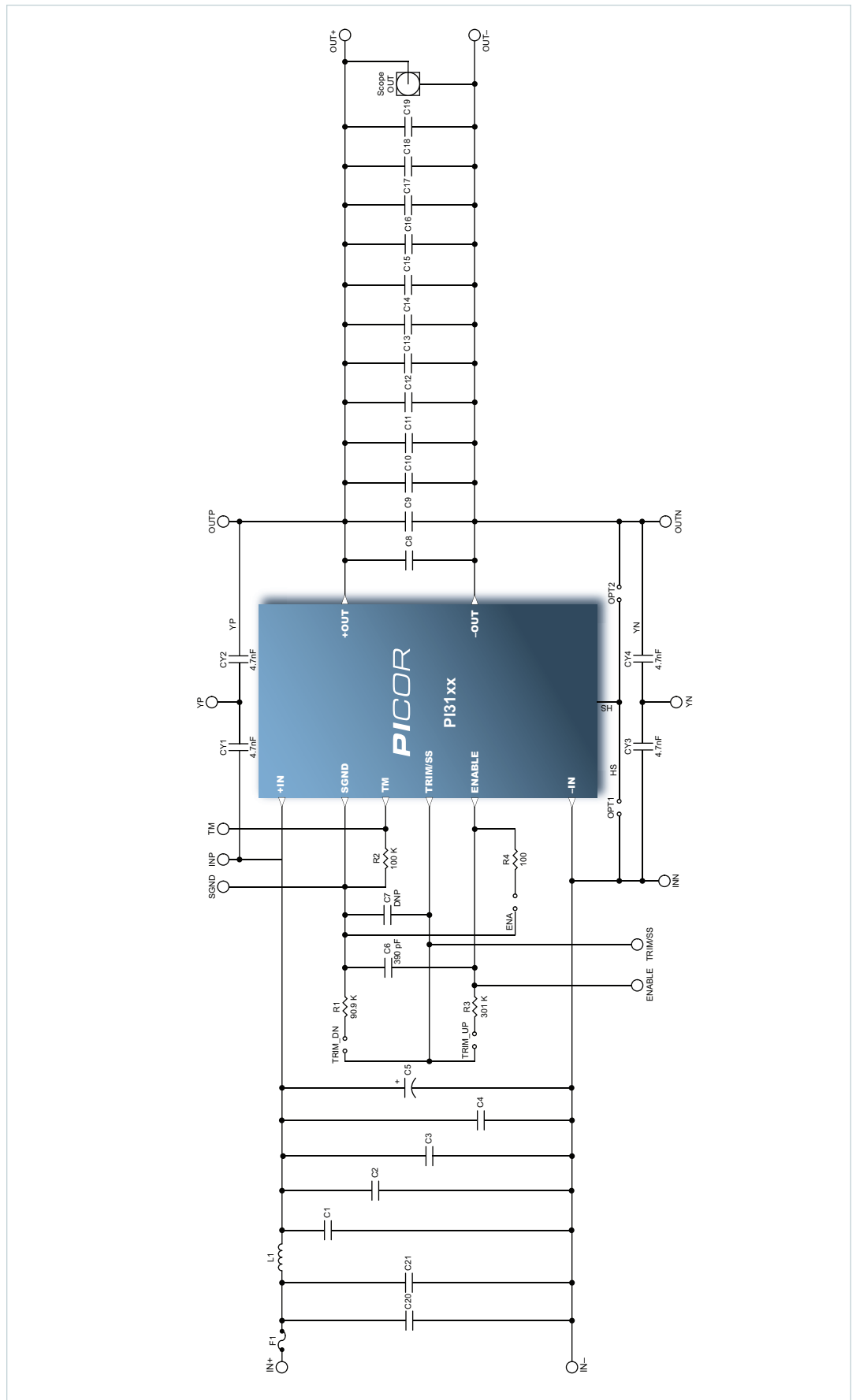

Table 4.  
PI3101-00-EVAL1  
Evaluation Board BOM

Item	Qty	Ref Design	Part #	Value	U/M	Description
1.	1	U1	PI3101-00-HVIZ	NA	EA	Picor PI3101-00 High Density PSiP
2.	12	C8-C19	GRM-21BR71A106KE5	10u	F	Murata X7R Ceramic Capacitor 10 V or equiv.
3.	6	C1-C4, C20-C21	GRM-31CR72A105KE1	1u	F	Murata X7R Ceramic Capacitor 100V or equiv.
4.	4	CY1-CY4	GRM-31BR73A472K	4700p	F	Murata X7R Ceramic Capacitor 1kV or equiv..
5.	1	L1	FP3-4R7-R	4.7u	H	Coilcraft Inductor
6.	1	C6	08055C391K-AT2A	390p	F	Kemet X7R Ceramic Capacitor 50V 0805
7.	1	C5	EEU-FC2A470	47u	F	Panasonic Electrolytic Capacitor 100V
8.	1	R1	MCR10EZPF9092	90.9k	Ohm	Rohm Resistor 0805 1% or equiv
9.	1	R3	MCR10EZPF3013	301k	Ohm	Rohm Resistor 0805 1% or equiv
10.	1	R2	MCR10EZPF1003	100k	Ohm	Rohm Resistor 0805 1% or equiv
11.	1	R4	MCR10EZPF1000	100	Ohm	Rohm Resistor 0805 1% or equiv
12.	1	F1	0154003DR	3	A	Littlefuse Fuseblock 3A SMT
13.	8		5015KCT-ND	N/A	N/A	Digi-Key SMT PC Test Point
14.	1	OUT	131503100	N/A	N/A	Tektronix Test Jack Assembly
15.	6	ENABLE, TRIM_UP, TRIM_DN	TSW-148-07-F-S	N/A	N/A	J,Header 0.1 "

Table 5.  
PI3105-00-EVAL1  
Evaluation Board BOM

Item	Qty	Ref Design	Part #	Value	U/M	Description
1.	1	U1	PI3105-00-HVIZ	NA	EA	Picor PI3105-00 High Density PSiP
2.	6	C8-C19	GRM-21BR71A475KE5	4.7u	F	Murata X7R Ceramic Capacitor 16V or equiv.
3.	6	C1-C4, C20-C21	GRM-31CR72A105KE1	1u	F	Murata X7R Ceramic Capacitor 100V or equiv.
4.	4	CY1-CY4	GRM-31BR73A472K	4700p	F	Murata X7R Ceramic Capacitor 1kV or equiv..
5.	1	L1	FP3-R47-R	470n	H	Coilcraft Inductor
6.	1	C6	08055C391K-AT2A	390p	F	Kemet X7R Ceramic Capacitor 50V 0805
7.	1	C5	EEU-FC2A470	47u	F	Panasonic Electrolytic Capacitor 100V
8.	1	R1	MCR10EZPF9092	90.9k	Ohm	Rohm Resistor 0805 1% or equiv
9.	1	R3	MCR10EZPF3013	301k	Ohm	Rohm Resistor 0805 1% or equiv
10.	1	R2	MCR10EZPF1003	100k	Ohm	Rohm Resistor 0805 1% or equiv
11.	1	R4	MCR10EZPF1000	100	Ohm	Rohm Resistor 0805 1% or equiv
12.	1	F1	0154003DR	3	A	Littlefuse Fuseblock 3A SMT
13.	8		5015KCT-ND	N/A	N/A	Digi-Key SMT PC Test Point
14.	1	OUT	131503100	N/A	N/A	Tektronix Test Jack Assembly
15.	6	ENABLE, TRIM_UP, TRIM_DN	TSW-148-07-F-S	N/A	N/A	J,Header 0.1 "

Table 6.  
PI3106-00-EVAL1  
Evaluation Board BOM

Item	Qty	Ref Design	Part #	Value	U/M	Description
1.	1	U1	PI3106-00-HVMZ	NA	EA	Picor PI3106-00 High Density PSiP
2.	6	C8-C19	GRM21BR71E-225KA73L	2.2u	F	Murata X7R Ceramic Capacitor 25V or equiv.
3.	6	C1-C4, C20-C21	GRM31CR71H-475KA12K	4.7u	F	Murata X7R Ceramic Capacitor 50V or equiv.
4.	4	CY1-CY4	GRM-31BR73A472K	4700p	F	Murata X7R Ceramic Capacitor 1kV or equiv..
5.	1	L1	FP3-R47-R	470n	H	Coilcraft Inductor
6.	1	C6	08055C391K-AT2A	390p	F	Kemet X7R Ceramic Capacitor 50V 0805
7.	1	C5	EEU-FC1J101L	100u	F	Panasonic Electrolytic Capacitor 63V
8.	1	R1	MCR10EZPF9092	90.9k	Ohm	Rohm Resistor 0805 1% or equiv
9.	1	R3	MCR10EZPF3013	301k	Ohm	Rohm Resistor 0805 1% or equiv
10.	1	R2	MCR10EZPF1003	100k	Ohm	Rohm Resistor 0805 1% or equiv
11.	1	R4	MCR10EZPF1000	100	Ohm	Rohm Resistor 0805 1% or equiv
12.	1	F1	0154008DR	8	A	Littlefuse Fuseblock 8A SMT
13.	8		5015KCT-ND	N/A	N/A	Digi-Key SMT PC Test Point
14.	1	OUT	131503100	N/A	N/A	Tektronix Test Jack Assembly
15.	6	ENABLE, TRIM UP, TRIM_DN	TSW-148-07-F-S	N/A	N/A	J,Header 0.1 "

Table 7.  
PI3106-01-EVAL1  
Evaluation Board BOM

Item	Qty	Ref Design	Part #	Value	U/M	Description
1.	1	U1	PI3106-01-HVIZ	NA	EA	Picor PI3106-01 High Density PSiP
2.	6	C8-C19	GRM21BR71E-225KA73L	2.2u	F	Murata X7R Ceramic Capacitor 25V or equiv.
3.	6	C1-C4, C20-C21	GRM31CR71H-475KA12K	4.7u	F	Murata X7R Ceramic Capacitor 50V or equiv.
4.	4	CY1-CY4	GRM-31BR73A472K	4700p	F	Murata X7R Ceramic Capacitor 1kV or equiv..
5.	1	L1	FP3-R47-R	470n	H	Coilcraft Inductor
6.	1	C6	08055C391K-AT2A	390p	F	Kemet X7R Ceramic Capacitor 50V 0805
7.	1	C5	EEU-FC1J101L	100u	F	Panasonic Electrolytic Capacitor 63V
8.	1	R1	MCR10EZPF9092	90.9k	Ohm	Rohm Resistor 0805 1% or equiv
9.	1	R3	MCR10EZPF3013	301k	Ohm	Rohm Resistor 0805 1% or equiv
10.	1	R2	MCR10EZPF1003	100k	Ohm	Rohm Resistor 0805 1% or equiv
11.	1	R4	MCR10EZPF1000	100	Ohm	Rohm Resistor 0805 1% or equiv
12.	1	F1	0154008DR	8	A	Littlefuse Fuseblock 8A SMT
13.	8		5015KCT-ND	N/A	N/A	Digi-Key SMT PC Test Point
14.	1	OUT	131503100	N/A	N/A	Tektronix Test Jack Assembly
15.	6	ENABLE, TRIM UP, TRIM_DN	TSW-148-07-F-S	N/A	N/A	J,Header 0.1 "



Table 8.  
PI3109-00-EVAL1  
Evaluation Board BOM

Item	Qty	Ref Design	Part #	Value	U/M	Description
1.	1	U1	PI3109-00-HVMZ	NA	EA	Picor PI3109-00 High Density PSiP
2.	6	C8-C19	GRM21BR71A-106KE5	10u	F	Murata X7R Ceramic Capacitor 10V or equiv.
3.	6	C1-C4, C20-C21	GRM31CR71H-475KA12K	4.7u	F	Murata X7R Ceramic Capacitor 50V or equiv.
4.	4	CY1-CY4	GRM-31BR73A472K	4700p	F	Murata X7R Ceramic Capacitor 1kV or equiv..
5.	1	L1	FP3-R47-R	470n	H	Coilcraft Inductor
6.	1	C6	08055C391K-AT2A	390p	F	Kemet X7R Ceramic Capacitor 50V 0805
7.	1	C5	EEU-FC1J101L	100u	F	Panasonic Electrolytic Capacitor 63V
8.	1	R1	MCR10EZPF9092	90.9k	Ohm	Rohm Resistor 0805 1% or equiv
9.	1	R3	MCR10EZPF3013	301k	Ohm	Rohm Resistor 0805 1% or equiv
10.	1	R2	MCR10EZPF1003	100k	Ohm	Rohm Resistor 0805 1% or equiv
11.	1	R4	MCR10EZPF1000	100	Ohm	Rohm Resistor 0805 1% or equiv
12.	1	F1	0154008DR	8	A	Littlefuse Fuseblock 8A SMT
13.	8		5015KCT-ND	N/A	N/A	Digi-Key SMT PC Test Point
14.	1	OUT	131503100	N/A	N/A	Tektronix Test Jack Assembly
15.	6	ENABLE, TRIM_UP, TRIM_DN	TSW-148-07-F-S	N/A	N/A	J,Header 0.1 "

Table 9.  
PI3109-01-EVAL1  
Evaluation Board BOM

Item	Qty	Ref Design	Part #	Value	U/M	Description
1.	1	U1	PI3109-01-HVIZ	NA	EA	Picor PI3109-01 High Density PSiP
2.	6	C8-C19	GRM21BR71A-106KE5	2.2u	F	Murata X7R Ceramic Capacitor 25V or equiv.
3.	6	C1-C4, C20-C21	GRM31CR71H-475KA12K	4.7u	F	Murata X7R Ceramic Capacitor 50V or equiv.
4.	4	CY1-CY4	GRM-31BR73A472K	4700p	F	Murata X7R Ceramic Capacitor 1kV or equiv..
5.	1	L1	FP3-R47-R	470n	H	Coilcraft Inductor
6.	1	C6	08055C391K-AT2A	390p	F	Kemet X7R Ceramic Capacitor 50V 0805
7.	1	C5	EEU-FC1J101L	100u	F	Panasonic Electrolytic Capacitor 63V
8.	1	R1	MCR10EZPF9092	90.9k	Ohm	Rohm Resistor 0805 1% or equiv
9.	1	R3	MCR10EZPF3013	301k	Ohm	Rohm Resistor 0805 1% or equiv
10.	1	R2	MCR10EZPF1003	100k	Ohm	Rohm Resistor 0805 1% or equiv
11.	1	R4	MCR10EZPF1000	100	Ohm	Rohm Resistor 0805 1% or equiv
12.	1	F1	0154008DR	8	A	Littlefuse Fuseblock 8A SMT
13.	8		5015KCT-ND	N/A	N/A	Digi-Key SMT PC Test Point
14.	1	OUT	131503100	N/A	N/A	Tektronix Test Jack Assembly
15.	6	ENABLE, TRIM_UP, TRIM_DN	TSW-148-07-F-S	N/A	N/A	J,Header 0.1 "

Table 10.  
PI3110-01-EVAL1  
Evaluation Board BOM

Item	Qty	Ref Design	Part #	Value	U/M	Description
1.	1	U1	PI3110-01-HVIZ	NA	EA	Picor PI3110-01 High Density PSiP
2.	6	C8-C19	GRM21BR71E-225KA73L	2.2u	F	Murata X7R Ceramic Capacitor 25V or equiv.
3.	6	C1-C4, C20-C21	GRM31CR71H-475KA12K	4.7u	F	Murata X7R Ceramic Capacitor 50V or equiv.
4.	4	CY1-CY4	GRM-31BR73A472K	4700p	F	Murata X7R Ceramic Capacitor 1kV or equiv..
5.	1	L1	FP3-4R7-R	4.7n	H	Coilcraft Inductor
6.	1	C6	08055C391K-AT2A	390p	F	Kemet X7R Ceramic Capacitor 50V 0805
7.	1	C5	EEU-FC2A470	47u	F	Panasonic Electrolytic Capacitor 100V
8.	1	R1	MCR10EZPF9092	90.9k	Ohm	Rohm Resistor 0805 1% or equiv
9.	1	R3	MCR10EZPF3013	301k	Ohm	Rohm Resistor 0805 1% or equiv
10.	1	R2	MCR10EZPF1003	100k	Ohm	Rohm Resistor 0805 1% or equiv
11.	1	R4	MCR10EZPF1000	100	Ohm	Rohm Resistor 0805 1% or equiv
12.	1	F1	0154003DR	3	A	Littlefuse Fuseblock 3A SMT
13.	8		5015KCT-ND	N/A	N/A	Digi-Key SMT PC Test Point
14.	1	OUT	131503100	N/A	N/A	Tektronix Test Jack Assembly
15.	6	ENABLE, TRIM_UP, TRIM_DN	TSW-148-07-F-S	N/A	N/A	J,Header 0.1 "

Table 11.  
PI3111-00-EVAL1  
Evaluation Board BOM

Item	Qty	Ref Design	Part #	Value	U/M	Description
1.	1	U1	PI3111-00-HVMZ	NA	EA	Picor PI3111-00 High Density PSiP
2.	6	C8-C19	GRM21BR71E-225KA73L	2.2u	F	Murata X7R Ceramic Capacitor 25V or equiv.
3.	6	C1-C4, C20-C21	GRM31CR71H-475KA12K	4.7u	F	Murata X7R Ceramic Capacitor 50V or equiv.
4.	4	CY1-CY4	GRM-31BR73A472K	4700p	F	Murata X7R Ceramic Capacitor 1kV or equiv.
5.	1	L1	FP3-4R7-R	4.7n	H	Coilcraft Inductor
6.	1	C6	08055C391K-AT2A	390p	F	Kemet X7R Ceramic Capacitor 50V 0805
7.	1	C5	EEU-FC1J101L	100u	F	Panasonic Electrolytic Capacitor 63V
8.	1	R1	MCR10EZPF9092	90.9k	Ohm	Rohm Resistor 0805 1% or equiv
9.	1	R3	MCR10EZPF3013	301k	Ohm	Rohm Resistor 0805 1% or equiv
10.	1	R2	MCR10EZPF1003	100k	Ohm	Rohm Resistor 0805 1% or equiv
11.	1	R4	MCR10EZPF1000	100	Ohm	Rohm Resistor 0805 1% or equiv
12.	1	F1	0154003DR	3	A	Littlefuse Fuseblock 3A SMT
13.	8		5015KCT-ND	N/A	N/A	Digi-Key SMT PC Test Point
14.	1	OUT	131503100	N/A	N/A	Tektronix Test Jack Assembly
15.	6	ENABLE, TRIM_UP, TRIM_DN	TSW-148-07-F-S	N/A	N/A	J,Header 0.1 "

Table 12.  
PI31xx-xx-EVAL1  
Packing List

Item	Qty	Part #	U/M	Description
1.	1	PI31xx-xx-EVAL1	EA	Evaluation PCB Assembly
2.	1	32786	EA	6.3mm Heatsink Assembly
3.	1	32784	EA	11mm Heatsink Assembly
4.	1	33855	EA	Heatsink Grounding Clip
5.	4	32434	EA	Heatsink Pushpins
6.	4	N/A	EA	Screw, 6-32
7.	4	N/A	EA	Nut, 6-32

Figure 6.  
PI31xx-xx-EVAL1 Test Setup

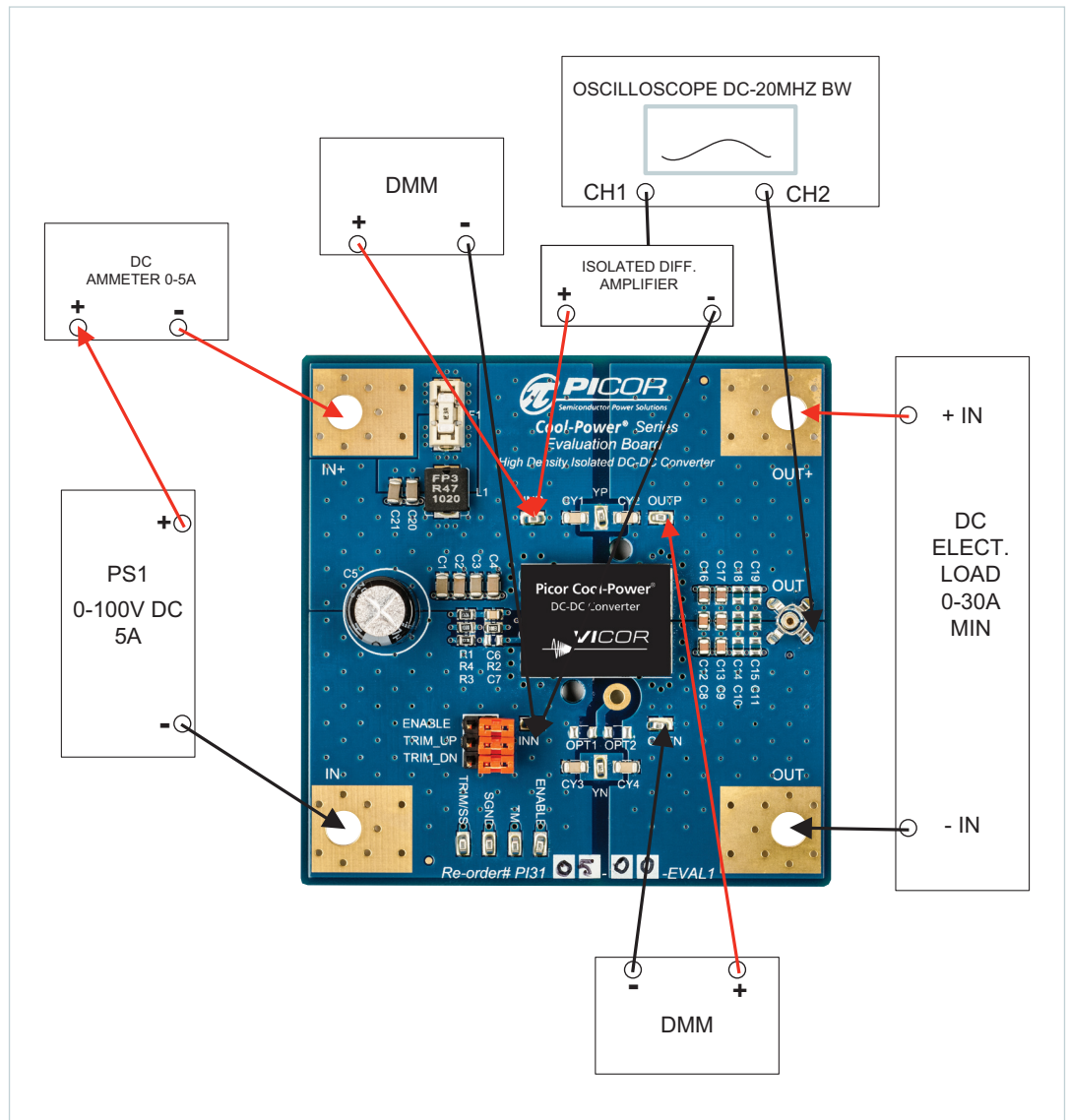

Figure 7.  
Top Layer  
Artwork 3 Oz Copper

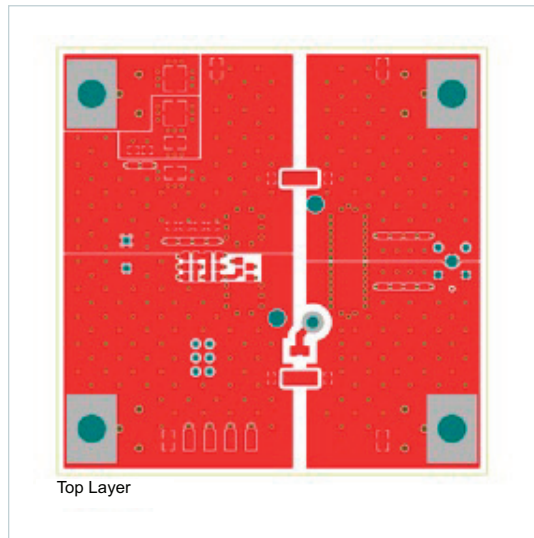

Figure 8.  
Midlayer 1  
Artwork 2 Oz Copper

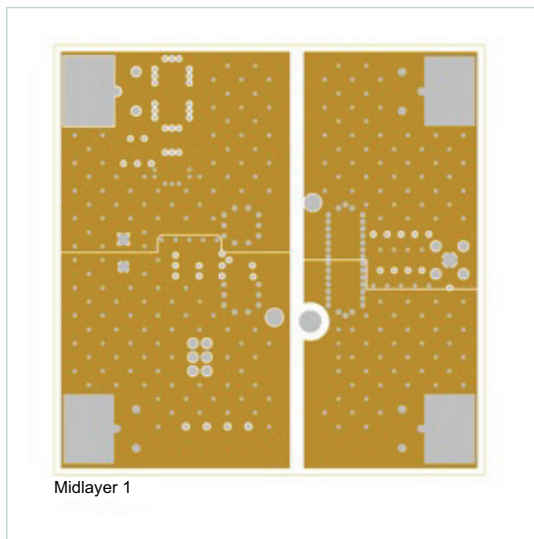

Figure 9.  
Midlayer 2  
Artwork 2 Oz. Copper

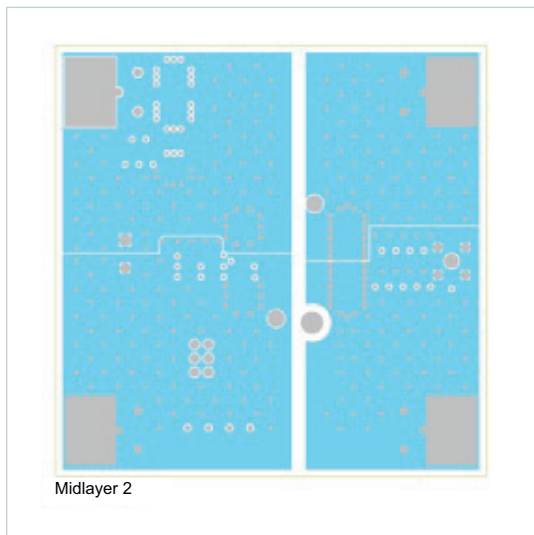

Figure 10.  
Midlayer 3  
Artwork 2 Oz. Copper

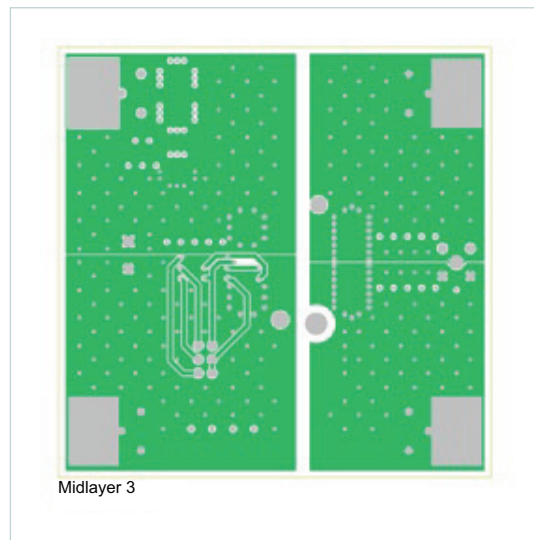

Figure 11.  
Midlayer 4  
Artwork 2 Oz. Copper

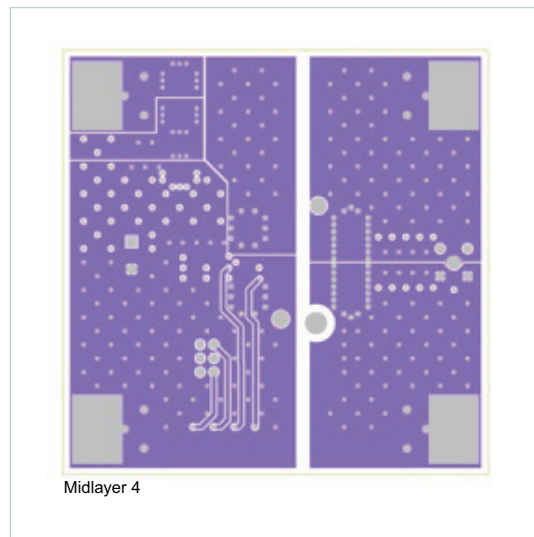

Figure 12.  
Bottom Layer  
Artwork 3 Oz. Copper

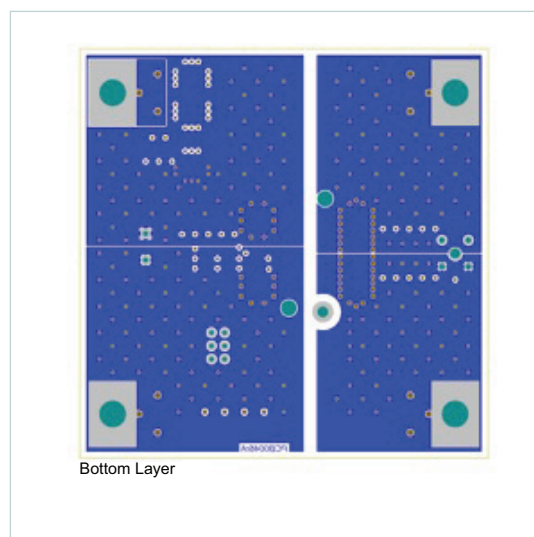
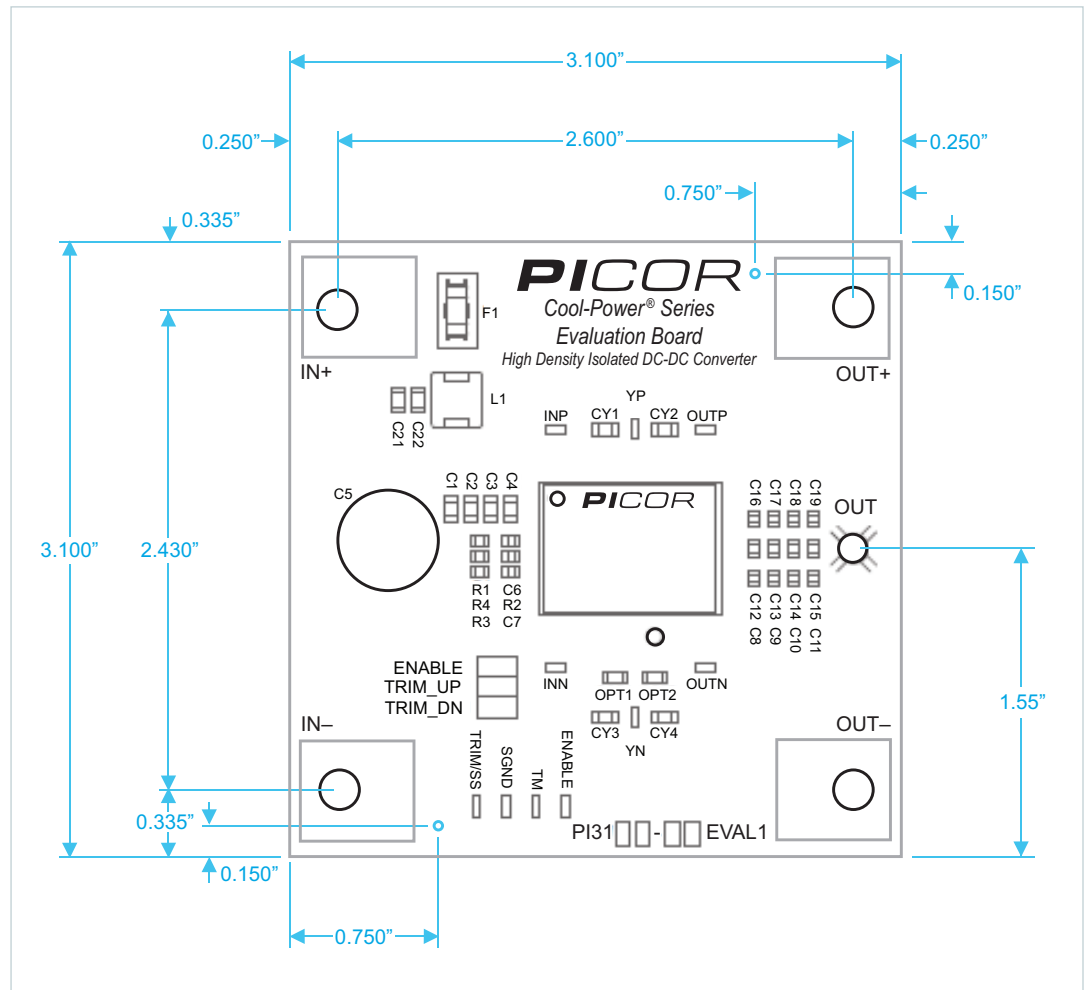

Figure 13.  
Mechanical Drawing



### Ordering Information

The PI31xx Customer Evaluation Boards are specified by adding the suffix “-EVAL1” to the base PI31xx-xx model number.

Go to <http://www.vicorpower.com/cms/home/company/contact-us> for ordering information.

**PICOR**  
Semiconductor Power Solutions



Компания «ЭлектроПласт» предлагает заключение долгосрочных отношений при поставках импортных электронных компонентов на взаимовыгодных условиях!

Наши преимущества:

- Оперативные поставки широкого спектра электронных компонентов отечественного и импортного производства напрямую от производителей и с крупнейших мировых складов;
- Поставка более 17-ти миллионов наименований электронных компонентов;
- Поставка сложных, дефицитных, либо снятых с производства позиций;
- Оперативные сроки поставки под заказ (от 5 рабочих дней);
- Экспресс доставка в любую точку России;
- Техническая поддержка проекта, помощь в подборе аналогов, поставка прототипов;
- Система менеджмента качества сертифицирована по Международному стандарту ISO 9001;
- Лицензия ФСБ на осуществление работ с использованием сведений, составляющих государственную тайну;
- Поставка специализированных компонентов (Xilinx, Altera, Analog Devices, Intersil, Interpoint, Microsemi, Aeroflex, Peregrine, Syfer, Eurofarad, Texas Instrument, Miteq, Cobham, E2V, MA-COM, Hittite, Mini-Circuits, General Dynamics и др.);

Помимо этого, одним из направлений компании «ЭлектроПласт» является направление «Источники питания». Мы предлагаем Вам помощь Конструкторского отдела:

- Подбор оптимального решения, техническое обоснование при выборе компонента;
- Подбор аналогов;
- Консультации по применению компонента;
- Поставка образцов и прототипов;
- Техническая поддержка проекта;
- Защита от снятия компонента с производства.



#### Как с нами связаться

**Телефон:** 8 (812) 309 58 32 (многоканальный)

**Факс:** 8 (812) 320-02-42

**Электронная почта:** [org@eplast1.ru](mailto:org@eplast1.ru)

**Адрес:** 198099, г. Санкт-Петербург, ул. Калинина, дом 2, корпус 4, литера А.