



FEATURES

- J-STD-020D reflow
- RoHS compliant
- 4 Configurations
- Primary inductance to 10mH
- 1kVrms isolation
- Industry standard pinout
- UL 94 V-0 package materials
- Low profile
- Toroidal construction

DESCRIPTION

The 786J series is a comprehensive range of general purpose pulse transformers. Common applications include line coupling, matching or isolating. The devices can also be used in small isolated power supplies and also as common-mode chokes in filtering applications.

For through hole variants please see 786 Series datasheet.

SELECTION GUIDE

Order Code	Turns Ratio	Min. Primary Inductance	Primary Min. Volt-time Product, Et	Typ. Leakage Inductance	Typ. Interwinding Capacitance	Max. Primary DC Resistance	Isolation Voltage	Winding Configuration
		μH	Vμs	μH	pF	Ω	Vrms	
78601/4JC	1:1	58	4	0.19	8	0.17	1000	1
78601/3JC	1:1	150	6	0.20	14	0.25		
78601/2JC	1:1	350	10	0.25	22	0.34		
78601/8JC	1:1	850	15	0.29	35	0.45		
78601/1JC	1:1	2000	20	0.47	49	0.60		
78601/16JC	1:1	3650	28	0.69	78	0.84	1000	2
78601/9JC	1:1	10000	56	0.93	121	1.30		
78602/4JC	1:1:1	53	4	0.11	12	0.18		
78602/3JC	1:1:1	180	6	0.17	19	0.24		
78602/2JC	1:1:1	380	10	0.27	32	0.34		
78602/8JC	1:1:1	970	15	0.37	47	0.46	1000	1
78602/1JC	1:1:1	1890	20	0.65	72	0.66		
78602/16JC	1:1:1	3350	28	0.71	116	1.20		
78602/9JC	1:1:1	10000	56	0.71	167	1.80		
78604/4JC	2:1	65	4	0.41	4	0.18		
78604/3JC	2:1	160	6	0.49	9	0.25	1000	1
78604/2JC	2:1	500	10	0.65	13	0.34		
78604/8JC	2:1	850	15	0.76	20	0.46		
78604/1JC	2:1	1840	20	0.99	29	0.60		
78604/16JC	2:1	3300	28	1.61	50	0.85		
78604/9JC	2:1	10000	56	2.30	72	1.23	1000	3
78613/4JC	1CT:1	50	4	0.30	7	0.20		
78613/3JC	1CT:1	190	6	0.65	12	0.25		
78613/2JC	1CT:1	490	10	1.07	20	0.36		
78613/8JC	1CT:1	980	15	1.13	35	0.48		
78613/1JC	1CT:1	2000	20	1.70	47	0.63	1000	4
78613/16JC	1CT:1	3200	28	2.80	64	0.88		
78613/9JC	1CT:1	10000	56	3.83	72	1.33		
78615/4JC	1CT:1CT	65	4	1.21	3	0.17		
78615/3JC	1CT:1CT	190	6	3.64	5	0.24		
78615/2JC	1CT:1CT	500	10	6.86	7	0.34	1000	4
78615/8JC	1CT:1CT	1000	15	11.9	10	0.45		
78615/1JC	1CT:1CT	1700	20	16.0	16	0.60		
78615/16JC	1CT:1CT	3700	28	37.7	20	0.92		
78615/9JC	1CT:1CT	10000	56	52.5	19	1.45		

ORDER CODE DETAILS

Order Code	Package Type	Packaging Type	Quantity
786XX/XJC	6 Pin SM	Tube	50
786XX/XJC-R	6 Pin SM	Tape & Reel	500

ABSOLUTE MAXIMUM RATINGS

Operating free air temperature range	-40°C to 85°C
Storage temperature range	-60°C to 125°C

SOLDERING INFORMATION¹

Pin finish	Matte tin
Max. peak reflow temperature	245°C
Moisture sensitivity level ²	1
Max. time above liquidous (217°C)	100s

All specifications typical at T_A=25°C

¹ For further information, please visit www.murata-ps.com/rohs

² Representative samples of the product were subjected to the conditioning described in IPC/JEDEC J-STD-020D and passed electrical testing, package coplanarity and visual inspection which revealed no external cracks or changes in package body flatness.



PACKAGE SPECIFICATIONS

MECHANICAL DIMENSIONS



Unless otherwise stated all dimensions in mm (inches) ± 0.25 (0.01). All pins on a 2.54 (0.1) pitch and within ± 0.25 (0.01) of true position.
Package Weight: 1.1g Typ.

RECOMMENDED FOOTPRINT DETAILS



Unless otherwise stated all dimensions in mm (inches) ± 0.25 (0.01). All pins on a 2.54 (0.1) pitch and within ± 0.25 (0.01) of true position.

WINDING CONFIGURATION (TOP VIEW)



* Pins only fitted on 786XX/XJC and 786XX/XJC-R variants.

TAPE & REEL SPECIFICATIONS

REEL OUTLINE DIMENSIONS

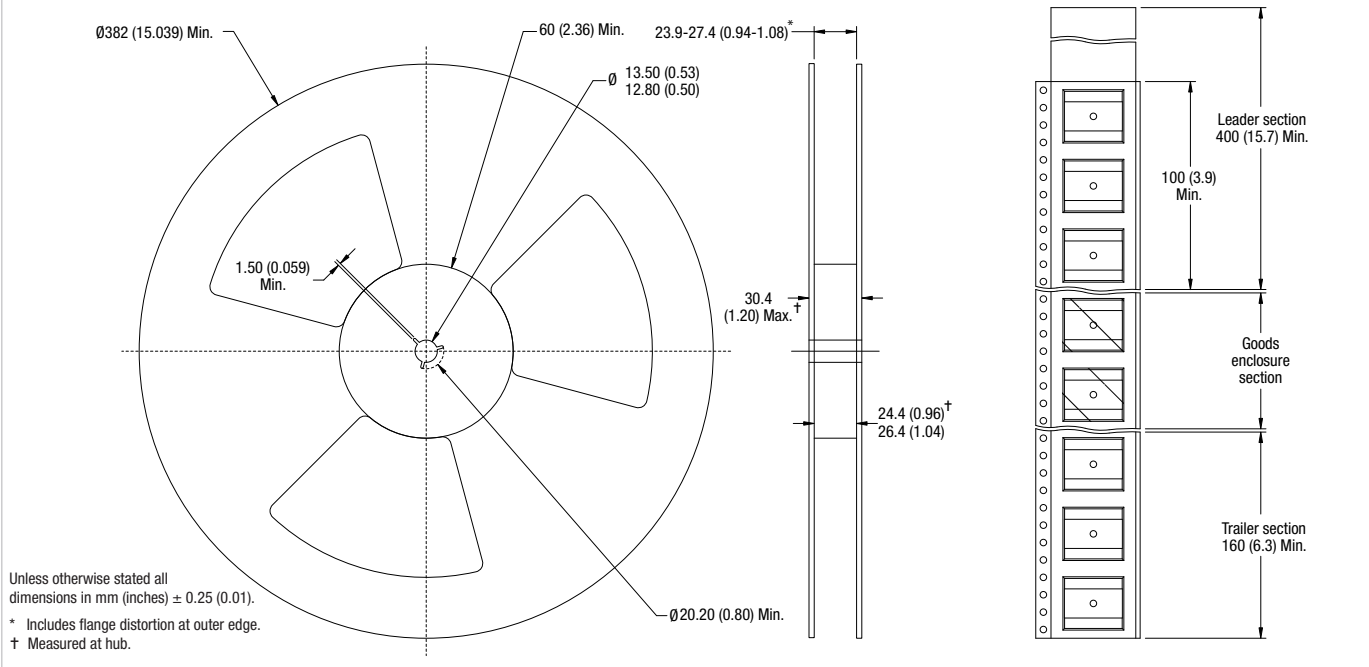

TAPE OUTLINE DIMENSIONS

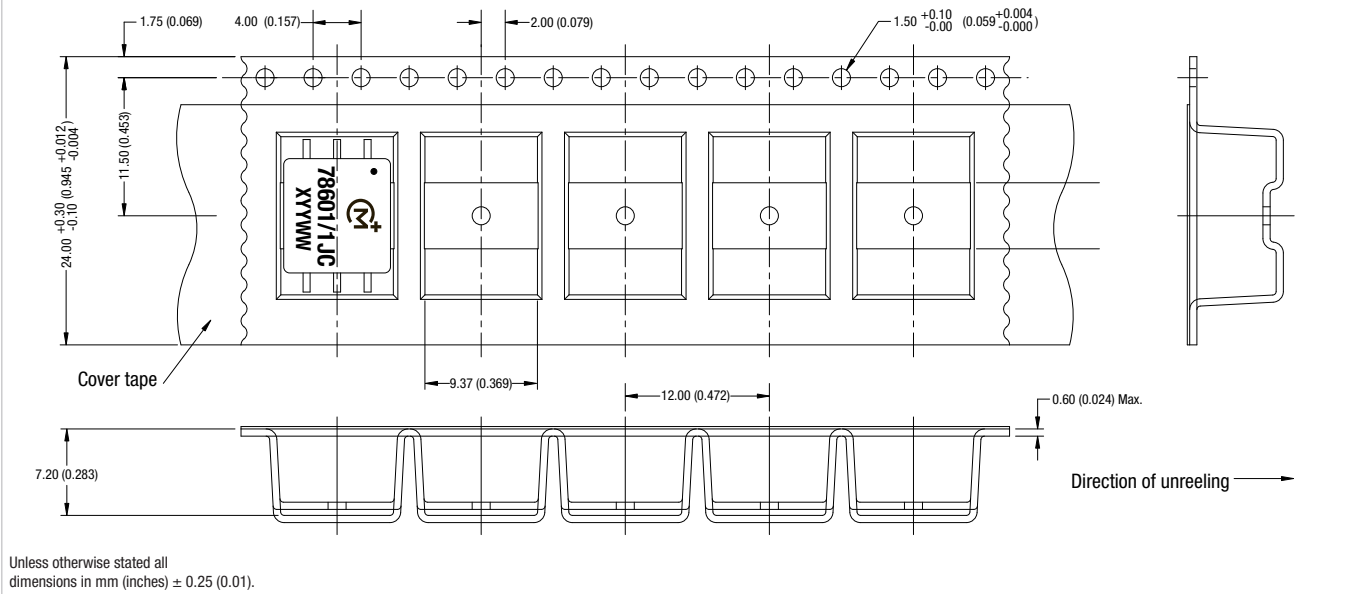

TUBE OUTLINE DIMENSIONS



Tube length: 465±2 (18.3±0.08). Tube quantity: 50.
 Tube material: Antistatic coated clear pvc.
 Unless otherwise stated all dimensions in mm (inches) ±0.25 (0.01).

TECHNICAL NOTES

ISOLATION VOLTAGE

'Hi Pot Test', 'Flash Tested', 'Withstand Voltage', 'Proof Voltage', 'Dielectric Withstand Voltage' & 'Isolation Test Voltage' are all terms that relate to the same thing, a test voltage, applied for a specified time, across a component designed to provide electrical isolation, to verify the integrity of that isolation.

All products in this series are 100% production tested at their stated isolation voltage.

A question commonly asked is, "What is the continuous voltage that can be applied across the part in normal operation?"

For a part holding no specific agency approvals both input and output should normally be maintained within SELV limits i.e. less than 42.4V peak, or 60VDC. The isolation test voltage represents a measure of immunity to transient voltages and the part should never be used as an element of a safety isolation system. The part could be expected to function correctly with several hundred volts offset applied continuously across the isolation barrier; but then the circuitry on both sides of the barrier must be regarded as operating at an unsafe voltage and further isolation/insulation systems must form a barrier between these circuits and any user-accessible circuitry according to safety standard requirements.

REPEATED HIGH-VOLTAGE ISOLATION TESTING

It is well known that repeated high-voltage isolation testing of a barrier component can actually degrade isolation capability, to a lesser or greater degree depending on materials, construction and environment. This series has toroidal isolation transformers, with no additional insulation between primary and secondary windings of enameled wire. While parts can be expected to withstand several times the stated test voltage, the isolation capability does depend on the wire insulation. Any material, including this enamel (typically polyurethane) is susceptible to eventual chemical degradation when subject to very high applied voltages thus implying that the number of tests should be strictly limited. We therefore strongly advise against repeated high voltage isolation testing, but if it is absolutely required, that the voltage be reduced by 20% from specified test voltage.

This consideration equally applies to agency recognized parts rated for better than functional isolation where the wire enamel insulation is always supplemented by a further insulation system of physical spacing or barriers.



Компания «ЭлектроПласт» предлагает заключение долгосрочных отношений при поставках импортных электронных компонентов на взаимовыгодных условиях!

Наши преимущества:

- Оперативные поставки широкого спектра электронных компонентов отечественного и импортного производства напрямую от производителей и с крупнейших мировых складов;
- Поставка более 17-ти миллионов наименований электронных компонентов;
- Поставка сложных, дефицитных, либо снятых с производства позиций;
- Оперативные сроки поставки под заказ (от 5 рабочих дней);
- Экспресс доставка в любую точку России;
- Техническая поддержка проекта, помощь в подборе аналогов, поставка прототипов;
- Система менеджмента качества сертифицирована по Международному стандарту ISO 9001;
- Лицензия ФСБ на осуществление работ с использованием сведений, составляющих государственную тайну;
- Поставка специализированных компонентов (Xilinx, Altera, Analog Devices, Intersil, Interpoint, Microsemi, Aeroflex, Peregrine, Syfer, Eurofarad, Texas Instrument, Miteq, Cobham, E2V, MA-COM, Hittite, Mini-Circuits, General Dynamics и др.);

Помимо этого, одним из направлений компании «ЭлектроПласт» является направление «Источники питания». Мы предлагаем Вам помощь Конструкторского отдела:

- Подбор оптимального решения, техническое обоснование при выборе компонента;
- Подбор аналогов;
- Консультации по применению компонента;
- Поставка образцов и прототипов;
- Техническая поддержка проекта;
- Защита от снятия компонента с производства.



Как с нами связаться

Телефон: 8 (812) 309 58 32 (многоканальный)

Факс: 8 (812) 320-02-42

Электронная почта: org@eplast1.ru

Адрес: 198099, г. Санкт-Петербург, ул. Калинина, дом 2, корпус 4, литера А.