

BZX84BxxxLT1G, BZX84CxxxLT1G Series, SZBZX84BxxxLT1G, SZBZX84CxxxLT1G Series



ON Semiconductor®

<http://onsemi.com>

Zener Voltage Regulators

225 mW SOT-23 Surface Mount

This series of Zener diodes is offered in the convenient, surface mount plastic SOT-23 package. These devices are designed to provide voltage regulation with minimum space requirement. They are well suited for applications such as cellular phones, hand held portables, and high density PC boards.

Features

- 225 mW Rating on FR-4 or FR-5 Board
- Zener Breakdown Voltage Range – 2.4 V to 75 V
- Package Designed for Optimal Automated Board Assembly
- Small Package Size for High Density Applications
- ESD Rating of Class 3 (> 16 kV) per Human Body Model
- Tight Tolerance Series Available (See Page 4)
- SZ Prefix for Automotive and Other Applications Requiring Unique Site and Control Change Requirements; AEC-Q101 Qualified and PPAP Capable
- These Devices are Pb-Free and are RoHS Compliant

Mechanical Characteristics

CASE: Void-free, transfer-molded, thermosetting plastic case

FINISH: Corrosion resistant finish, easily Solderable

MAXIMUM CASE TEMPERATURE FOR SOLDERING PURPOSES:

260°C for 10 Seconds

POLARITY: Cathode indicated by polarity band

FLAMMABILITY RATING: UL 94 V-0

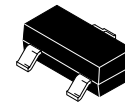

SOT-23
CASE 318
STYLE 8

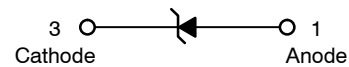

MARKING DIAGRAM

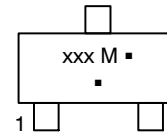

xxx = Device Code
M = Date Code*
▪ = Pb-Free Package

(Note: Microdot may be in either location)

*Date Code orientation may vary depending upon manufacturing location.

ORDERING INFORMATION

| Device | Package | Shipping† |
|-----------------|------------------|----------------------|
| BZX84CxxxLT1G | SOT-23 (Pb-Free) | 3,000 / Tape & Reel |
| SZBZX84CxxxLT1G | SOT-23 (Pb-Free) | 3,000 / Tape & Reel |
| BZX84CxxxLT3G | SOT-23 (Pb-Free) | 10,000 / Tape & Reel |
| SZBZX84CxxxLT3G | SOT-23 (Pb-Free) | 10,000 / Tape & Reel |
| BZX84BxxxLT1G | SOT-23 (Pb-Free) | 3,000 / Tape & Reel |
| SZBZX84BxxxLT1G | SOT-23 (Pb-Free) | 3,000 / Tape & Reel |
| BZX84BxxxLT3G | SOT-23 (Pb-Free) | 10,000 / Tape & Reel |

†For information on tape and reel specifications, including part orientation and tape sizes, please refer to our Tape and Reel Packaging Specification Brochure, BRD8011/D.

DEVICE MARKING INFORMATION

See specific marking information in the device marking column of the Electrical Characteristics table on page 3 of this data sheet.

*For additional information on our Pb-Free strategy and soldering details, please download the ON Semiconductor Soldering and Mounting Techniques Reference Manual, SOLDERRM/D.

BZX84BxxxLT1G, BZX84CxxxLT1G Series, SZBZX84BxxxLT1G, SZBZX84CxxxLT1G Series

MAXIMUM RATINGS

| Rating | Symbol | Max | Unit |
|--|-----------------|-------------|----------------------------|
| Total Power Dissipation on FR-5 Board, (Note 1) @ $T_A = 25^\circ\text{C}$ Derated above 25°C | P_D | 225 | mW |
| Thermal Resistance, Junction-to-Ambient | $R_{\theta JA}$ | 1.8 | $\text{mW}/^\circ\text{C}$ |
| Total Power Dissipation on Alumina Substrate, (Note 2) @ $T_A = 25^\circ\text{C}$ Derated above 25°C | P_D | 300 | mW |
| Thermal Resistance, Junction-to-Ambient | $R_{\theta JA}$ | 2.4 | $\text{mW}/^\circ\text{C}$ |
| Junction and Storage Temperature Range | T_J, T_{stg} | -65 to +150 | $^\circ\text{C}$ |

Stresses exceeding Maximum Ratings may damage the device. Maximum Ratings are stress ratings only. Functional operation above the Recommended Operating Conditions is not implied. Extended exposure to stresses above the Recommended Operating Conditions may affect device reliability.

- FR-5 = 1.0 X 0.75 X 0.62 in.
- Alumina = 0.4 X 0.3 X 0.024 in., 99.5% alumina.

ELECTRICAL CHARACTERISTICS

(Pinout: 1-Anode, 2-No Connection, 3-Cathode) ($T_A = 25^\circ\text{C}$ unless otherwise noted, $V_F = 0.90\text{ V Max. @ } I_F = 10\text{ mA}$)

| Symbol | Parameter |
|--------------|---|
| V_Z | Reverse Zener Voltage @ I_{ZT} |
| I_{ZT} | Reverse Current |
| Z_{ZT} | Maximum Zener Impedance @ I_{ZT} |
| I_R | Reverse Leakage Current @ V_R |
| V_R | Reverse Voltage |
| I_F | Forward Current |
| V_F | Forward Voltage @ I_F |
| ΘV_Z | Maximum Temperature Coefficient of V_Z |
| C | Max. Capacitance @ $V_R = 0$ and $f = 1\text{ MHz}$ |

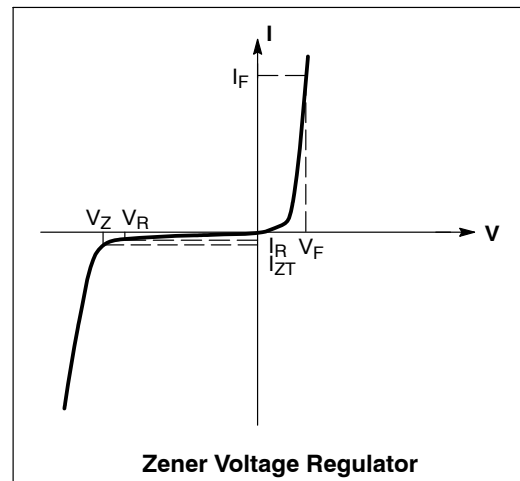

BZX84BxxxLT1G, BZX84CxxxLT1G Series, SZBZX84BxxxLT1G, SZBZX84CxxxLT1G Series

ELECTRICAL CHARACTERISTICS – BZX84CxxxLT1 SERIES (STANDARD TOLERANCE)

(Pinout: 1-Anode, 2-No Connection, 3-Cathode) (T_A = 25°C unless otherwise noted, V_F = 0.90 V Max. @ I_F = 10 mA)
 (Devices listed in **bold, italic** are ON Semiconductor Preferred devices.)

| Device* | Device Marking | V _{Z1} (Volts) @ I _{ZT1} = 5 mA (Note 3) | | | Z _{ZT1} (Ω) @ I _{ZT1} = 5 mA | V _{Z2} (V) @ I _{ZT2} = 1 mA (Note 3) | | Z _{ZT2} (Ω) @ I _{ZT2} = 1 mA | V _{Z3} (V) @ I _{ZT3} = 20 mA (Note 3) | | Z _{ZT3} (Ω) @ I _{ZT3} = 20 mA | Max Reverse Leakage Current | | θ _{VZ} (mV/k) @ I _{ZT1} = 5 mA | | C (pF) @ V _R = 0 f = 1 MHz |
|-------------------------|----------------|--|------------|-------------|---|--|-------------|---|---|-------------|--|-----------------------------|------------------------|---|-------------|---|
| | | Min | Nom | Max | | Min | Max | | Min | Max | | I _R (μA) | V _R (Volts) | Min | Max | |
| | | Min | Nom | Max | Min | Max | Min | Max | Min | Max | I _R (μA) | V _R (Volts) | Min | Max | | |
| BZX84C2V4LT1G | Z11 | 2.2 | 2.4 | 2.6 | 100 | 1.7 | 2.1 | 600 | 2.6 | 3.2 | 50 | 50 | 1 | -3.5 | 0 | 450 |
| BZX84C2V7LT1G | Z12 | 2.5 | 2.7 | 2.9 | 100 | 1.9 | 2.4 | 600 | 3 | 3.6 | 50 | 20 | 1 | -3.5 | 0 | 450 |
| BZX84C3V0LT1G | Z13 | 2.8 | 3 | 3.2 | 95 | 2.1 | 2.7 | 600 | 3.3 | 3.9 | 50 | 10 | 1 | -3.5 | 0 | 450 |
| BZX84C3V3LT1G | Z14 | 3.1 | 3.3 | 3.5 | 95 | 2.3 | 2.9 | 600 | 3.6 | 4.2 | 40 | 5 | 1 | -3.5 | 0 | 450 |
| BZX84C3V6LT1G | Z15 | 3.4 | 3.6 | 3.8 | 90 | 2.7 | 3.3 | 600 | 3.9 | 4.5 | 40 | 5 | 1 | -3.5 | 0 | 450 |
| BZX84C3V9LT1G | Z16 | 3.7 | 3.9 | 4.1 | 90 | 2.9 | 3.5 | 600 | 4.1 | 4.7 | 30 | 3 | 1 | -3.5 | -2.5 | 450 |
| BZX84C4V3LT1G | W9 | 4 | 4.3 | 4.6 | 90 | 3.3 | 4 | 600 | 4.4 | 5.1 | 30 | 3 | 1 | -3.5 | 0 | 450 |
| BZX84C4V7LT1/T3G | Z1 | 4.4 | 4.7 | 5 | 80 | 3.7 | 4.7 | 500 | 4.5 | 5.4 | 15 | 3 | 2 | -3.5 | 0.2 | 260 |
| BZX84C5V1LT1/T3G | Z2 | 4.8 | 5.1 | 5.4 | 60 | 4.2 | 5.3 | 480 | 5 | 5.9 | 15 | 2 | 2 | -2.7 | 1.2 | 225 |
| BZX84C5V6LT1/T3G | Z3 | 5.2 | 5.6 | 6 | 40 | 4.8 | 6 | 400 | 5.2 | 6.3 | 10 | 1 | 2 | -2.0 | 2.5 | 200 |
| BZX84C6V2LT1/T3G | Z4 | 5.8 | 6.2 | 6.6 | 10 | 5.6 | 6.6 | 150 | 5.8 | 6.8 | 6 | 3 | 4 | 0.4 | 3.7 | 185 |
| BZX84C6V8LT1/T3G | Z5 | 6.4 | 6.8 | 7.2 | 15 | 6.3 | 7.2 | 80 | 6.4 | 7.4 | 6 | 2 | 4 | 1.2 | 4.5 | 155 |
| BZX84C7V5LT1G | Z6 | 7 | 7.5 | 7.9 | 15 | 6.9 | 7.9 | 80 | 7 | 8 | 6 | 1 | 5 | 2.5 | 5.3 | 140 |
| BZX84C8V2LT1G | Z7 | 7.7 | 8.2 | 8.7 | 15 | 7.6 | 8.7 | 80 | 7.7 | 8.8 | 6 | 0.7 | 5 | 3.2 | 6.2 | 135 |
| BZX84C9V1LT1/T3G | Z8 | 8.5 | 9.1 | 9.6 | 15 | 8.4 | 9.6 | 100 | 8.5 | 9.7 | 8 | 0.5 | 6 | 3.8 | 7.0 | 130 |
| BZX84C10LT1G | Z9 | 9.4 | 10 | 10.6 | 20 | 9.3 | 10.6 | 150 | 9.4 | 10.7 | 10 | 0.2 | 7 | 4.5 | 8.0 | 130 |
| BZX84C11LT1G | Y1 | 10.4 | 11 | 11.6 | 20 | 10.2 | 11.6 | 150 | 10.4 | 11.8 | 10 | 0.1 | 8 | 5.4 | 9.0 | 130 |
| BZX84C12LT1G | Y2 | 11.4 | 12 | 12.7 | 25 | 11.2 | 12.7 | 150 | 11.4 | 12.9 | 10 | 0.1 | 8 | 6.0 | 10.0 | 130 |
| BZX84C13LT1G | Y3 | 12.4 | 13 | 14.1 | 30 | 12.3 | 14 | 170 | 12.5 | 14.2 | 15 | 0.1 | 8 | 7.0 | 11.0 | 120 |
| BZX84C15LT1/T3G | Y4 | 13.8 | 15 | 15.6 | 30 | 13.7 | 15.5 | 200 | 13.9 | 15.7 | 20 | 0.05 | 10.5 | 9.2 | 13.0 | 110 |
| BZX84C16LT1G | Y5 | 15.3 | 16 | 17.1 | 40 | 15.2 | 17 | 200 | 15.4 | 17.2 | 20 | 0.05 | 11.2 | 10.4 | 14.0 | 105 |
| BZX84C18LT1/T3G | Y6 | 16.8 | 18 | 19.1 | 45 | 16.7 | 19 | 225 | 16.9 | 19.2 | 20 | 0.05 | 12.6 | 12.4 | 16.0 | 100 |
| BZX84C20LT1G | Y7 | 18.8 | 20 | 21.2 | 55 | 18.7 | 21.1 | 225 | 18.9 | 21.4 | 20 | 0.05 | 14 | 14.4 | 18.0 | 85 |
| BZX84C22LT1G | Y8 | 20.8 | 22 | 23.3 | 55 | 20.7 | 23.2 | 250 | 20.9 | 23.4 | 25 | 0.05 | 15.4 | 16.4 | 20.0 | 85 |
| BZX84C24LT1G | Y9 | 22.8 | 24 | 25.6 | 70 | 22.7 | 25.5 | 250 | 22.9 | 25.7 | 25 | 0.05 | 16.8 | 18.4 | 22.0 | 80 |
| Device* | Device Marking | V _{Z1} Below @ I _{ZT1} = 2 mA | | | Z _{ZT1} Below @ I _{ZT1} = 2 mA | V _{Z2} Below @ I _{ZT2} = 0.1 mA | | Z _{ZT2} Below @ I _{ZT2} = 0.5 mA | V _{Z3} Below @ I _{ZT3} = 10 mA | | Z _{ZT3} Below @ I _{ZT3} = 10 mA | Max Reverse Leakage Current | | θ _{VZ} (mV/k) Below @ I _{ZT1} = 2 mA | | C (pF) @ V _R = 0 f = 1 MHz |
| | | Min | Nom | Max | | Min | Max | | Min | Max | | I _R (μA) | V _R (V) | Min | Max | |
| | | Min | Nom | Max | Min | Max | Min | Max | Min | Max | I _R (μA) | V _R (V) | Min | Max | | |
| BZX84C27LT1G | Y10 | 25.1 | 27 | 28.9 | 80 | 25 | 28.9 | 300 | 25.2 | 29.3 | 45 | 0.05 | 18.9 | 21.4 | 25.3 | 70 |
| BZX84C30LT1G | Y11 | 28 | 30 | 32 | 80 | 27.8 | 32 | 300 | 28.1 | 32.4 | 50 | 0.05 | 21 | 24.4 | 29.4 | 70 |
| BZX84C33LT1/T3G | Y12 | 31 | 33 | 35 | 80 | 30.8 | 35 | 325 | 31.1 | 35.4 | 55 | 0.05 | 23.1 | 27.4 | 33.4 | 70 |
| BZX84C36LT1G | Y13 | 34 | 36 | 38 | 90 | 33.8 | 38 | 350 | 34.1 | 38.4 | 60 | 0.05 | 25.2 | 30.4 | 37.4 | 70 |
| BZX84C39LT1G | Y14 | 37 | 39 | 41 | 130 | 36.7 | 41 | 350 | 37.1 | 41.5 | 70 | 0.05 | 27.3 | 33.4 | 41.2 | 45 |
| BZX84C43LT1G | Y15 | 40 | 43 | 46 | 150 | 39.7 | 46 | 375 | 40.1 | 46.5 | 80 | 0.05 | 30.1 | 37.6 | 46.6 | 40 |
| BZX84C47LT1G | Y16 | 44 | 47 | 50 | 170 | 43.7 | 50 | 375 | 44.1 | 50.5 | 90 | 0.05 | 32.9 | 42.0 | 51.8 | 40 |
| BZX84C51LT1G | Y17 | 48 | 51 | 54 | 180 | 47.6 | 54 | 400 | 48.1 | 54.6 | 100 | 0.05 | 35.7 | 46.6 | 57.2 | 40 |
| BZX84C56LT1G | Y18 | 52 | 56 | 60 | 200 | 51.5 | 60 | 425 | 52.1 | 60.8 | 110 | 0.05 | 39.2 | 52.2 | 63.8 | 40 |
| BZX84C62LT1G | Y19 | 58 | 62 | 66 | 215 | 57.4 | 66 | 450 | 58.2 | 67 | 120 | 0.05 | 43.4 | 58.8 | 71.6 | 35 |
| BZX84C68LT1G | Y20 | 64 | 68 | 72 | 240 | 63.4 | 72 | 475 | 64.2 | 73.2 | 130 | 0.05 | 47.6 | 65.6 | 79.8 | 35 |
| BZX84C75LT1G | Y21 | 70 | 75 | 79 | 255 | 69.4 | 79 | 500 | 70.3 | 80.2 | 140 | 0.05 | 52.5 | 73.4 | 88.6 | 35 |

3. Zener voltage is measured with a pulse test current I_Z at an ambient temperature of 25°C.

*Include SZ-prefix devices where applicable.

BZX84BxxxLT1G, BZX84CxxxLT1G Series, SZBZX84BxxxLT1G, SZBZX84CxxxLT1G Series

ELECTRICAL CHARACTERISTICS – BZX84BxxxL (Tight Tolerance Series)

(Pinout: 1-Anode, 2-No Connection, 3-Cathode) ($T_A = 25^\circ\text{C}$ unless otherwise noted, $V_F = 0.90\text{ V Max.}$ @ $I_F = 10\text{ mA}$)

| Device* | Device Marking | V_Z (Volts) @ $I_{ZT} = 5\text{ mA}$ (Note 4) | | | Z_{ZT} (Ω) @ $I_{ZT} = 5\text{ mA}$ (Note 4) | Max Reverse Leakage Current | | θ_{VZ} (mV/k) @ $I_{ZT} = 5\text{ mA}$ | | C (pF) @ $V_R = 0,$ $f = 1\text{ MHz}$ |
|---------------|----------------|--|-----|------|---|-----------------------------|---------|---|-----|--|
| | | | | | | I_R | V_R | | | |
| | | Min | Nom | Max | Max | μA | @ Volts | Min | Max | |
| BZX84B4V7LT1G | T10 | 4.61 | 4.7 | 4.79 | 80 | 3 | 2 | -3.5 | 0.2 | 260 |
| BZX84B5V1LT1G | T11 | 5.00 | 5.1 | 5.20 | 60 | 2 | 2 | -2.7 | 1.2 | 225 |
| BZX84B5V6LT1G | T12 | 5.49 | 5.6 | 5.71 | 40 | 1 | 2 | -2 | 2.5 | 200 |
| BZX84B6V2LT1G | T13 | 6.08 | 6.2 | 6.32 | 10 | 3 | 4 | 0.4 | 3.7 | 185 |
| BZX84B6V8LT1G | T14 | 6.66 | 6.8 | 6.94 | 15 | 2 | 4 | 1.2 | 4.5 | 155 |
| BZX84B7V5LT1G | T15 | 7.35 | 7.5 | 7.65 | 15 | 1 | 5 | 2.5 | 5.3 | 140 |
| BZX84B8V2LT1G | T16 | 8.04 | 8.2 | 8.36 | 15 | 0.7 | 5 | 3.2 | 6.2 | 135 |
| BZX84B9V1LT1G | T17 | 8.92 | 9.1 | 9.28 | 15 | 0.5 | 6 | 3.8 | 7 | 130 |
| BZX84B12LT1G | T18 | 11.8 | 12 | 12.2 | 25 | 0.1 | 8 | 6 | 10 | 130 |
| BZX84B15LT1G | T22 | 14.7 | 15 | 15.3 | 30 | 0.05 | 10.5 | 9.2 | 13 | 110 |
| BZX84B16LT1G | T19 | 15.7 | 16 | 16.3 | 40 | 0.05 | 11.2 | 10.4 | 14 | 105 |
| BZX84B18LT1G | T20 | 17.6 | 18 | 18.4 | 45 | 0.05 | 12.6 | 12.4 | 16 | 100 |
| BZX84B22LT1G | T24 | 21.6 | 22 | 22.4 | 55 | 0.05 | 15.4 | 16.4 | 20 | 85 |
| BZX84B24LT1G | T25 | 23.5 | 24 | 24.5 | 70 | 0.05 | 16.8 | 18.4 | 22 | 80 |

4. Zener voltage is measured with a pulse test current I_Z at an ambient temperature of 25°C .

*Include SZ-prefix devices where applicable.

BZX84BxxxLT1G, BZX84CxxxLT1G Series, SZBZX84BxxxLT1G, SZBZX84CxxxLT1G Series

TYPICAL CHARACTERISTICS

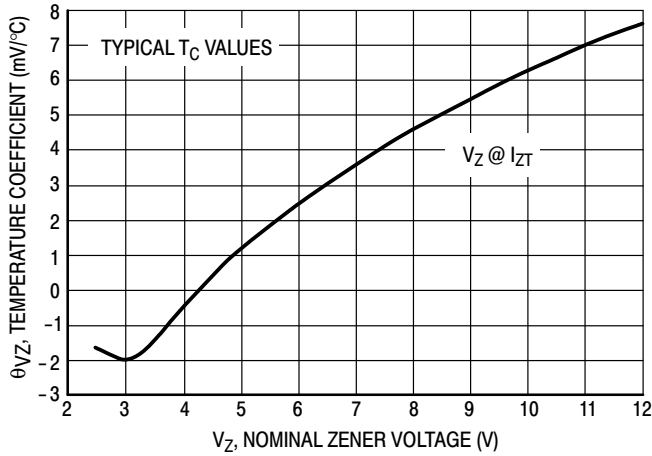

Figure 1. Temperature Coefficients (Temperature Range -55°C to +150°C)

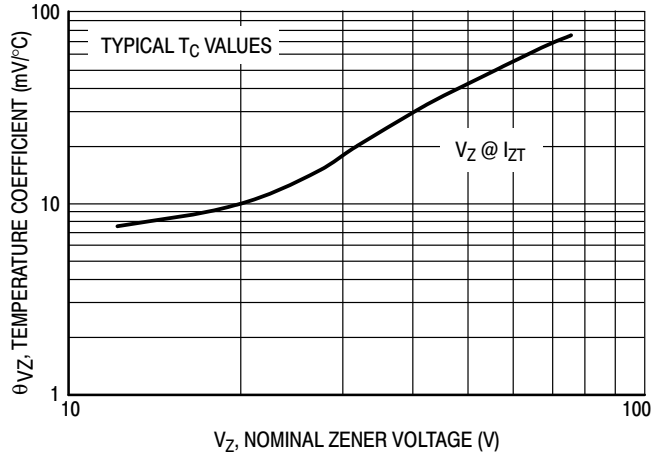

Figure 2. Temperature Coefficients (Temperature Range -55°C to +150°C)

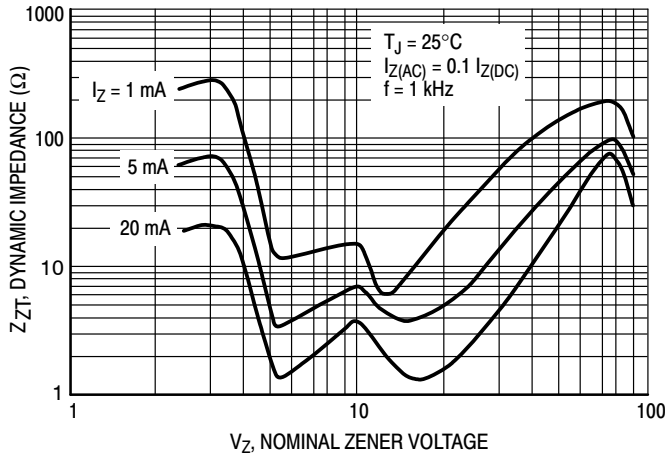

Figure 3. Effect of Zener Voltage on Zener Impedance

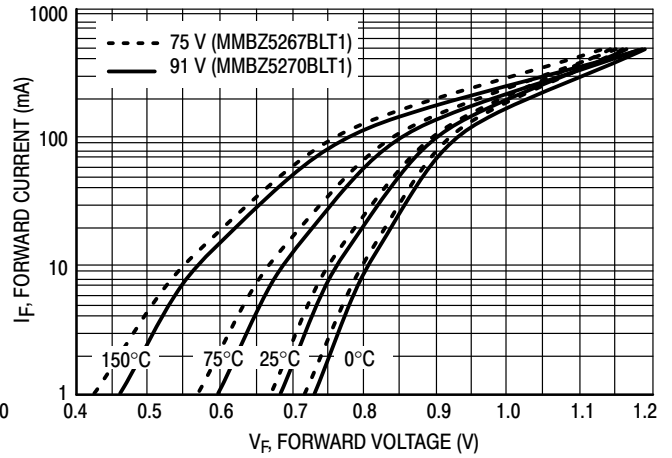

Figure 4. Typical Forward Voltage

BZX84BxxxLT1G, BZX84CxxxLT1G Series, SZBZX84BxxxLT1G, SZBZX84CxxxLT1G Series

TYPICAL CHARACTERISTICS

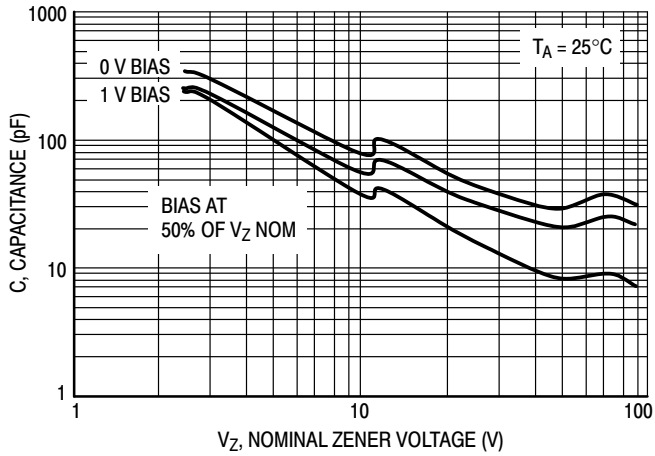

Figure 5. Typical Capacitance

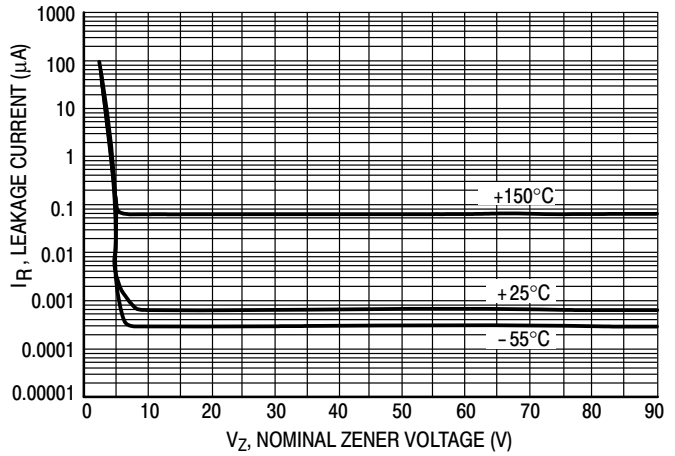
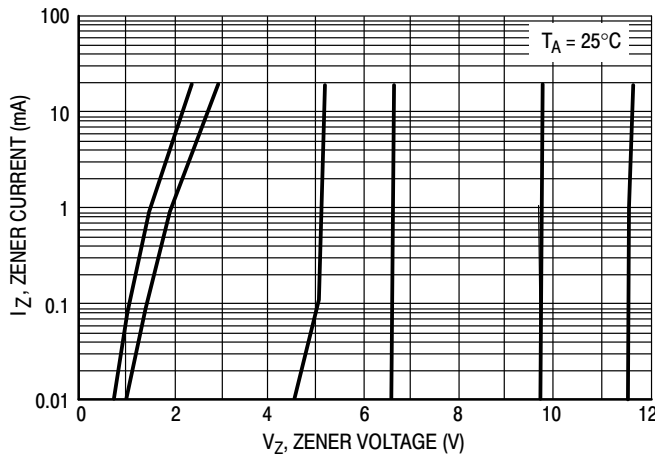
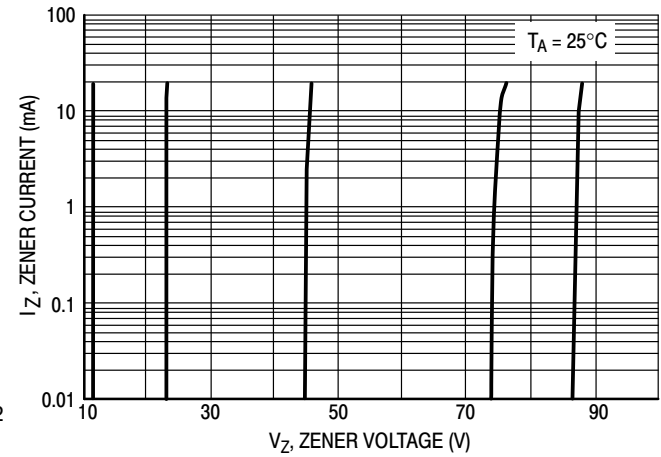

Figure 6. Typical Leakage Current



**Figure 7. Zener Voltage versus Zener Current
(V_Z Up to 12 V)**

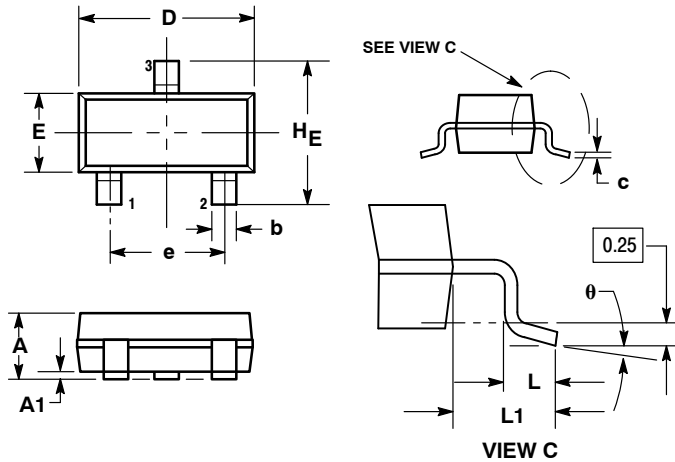

**Figure 8. Zener Voltage versus Zener Current
(12 V to 91 V)**

BZX84BxxxLT1G, BZX84CxxxLT1G Series, SZBZX84BxxxLT1G, SZBZX84CxxxLT1G Series

PACKAGE DIMENSIONS

SOT-23 (TO-236)
CASE 318-08
ISSUE AP



NOTES:

1. DIMENSIONING AND TOLERANCING PER ANSI Y14.5M, 1982.
2. CONTROLLING DIMENSION: INCH.
3. MAXIMUM LEAD THICKNESS INCLUDES LEAD FINISH THICKNESS. MINIMUM LEAD THICKNESS IS THE MINIMUM THICKNESS OF BASE MATERIAL.
4. DIMENSIONS D AND E DO NOT INCLUDE MOLD FLASH, PROTRUSIONS, OR GATE BURRS.

| DIM | MILLIMETERS | | | INCHES | | |
|-----|-------------|------|------|--------|-------|-------|
| | MIN | NOM | MAX | MIN | NOM | MAX |
| A | 0.89 | 1.00 | 1.11 | 0.035 | 0.040 | 0.044 |
| A1 | 0.01 | 0.06 | 0.10 | 0.001 | 0.002 | 0.004 |
| b | 0.37 | 0.44 | 0.50 | 0.015 | 0.018 | 0.020 |
| c | 0.09 | 0.13 | 0.18 | 0.003 | 0.005 | 0.007 |
| D | 2.80 | 2.90 | 3.04 | 0.110 | 0.114 | 0.120 |
| E | 1.20 | 1.30 | 1.40 | 0.047 | 0.051 | 0.055 |
| e | 1.78 | 1.90 | 2.04 | 0.070 | 0.075 | 0.081 |
| L | 0.10 | 0.20 | 0.30 | 0.004 | 0.008 | 0.012 |
| L1 | 0.35 | 0.54 | 0.69 | 0.014 | 0.021 | 0.029 |
| HE | 2.10 | 2.40 | 2.64 | 0.083 | 0.094 | 0.104 |
| θ | 0° | --- | 10° | 0° | --- | 10° |

STYLE 8:

1. ANODE
2. NO CONNECTION
3. CATHODE

SOLDERING FOOTPRINT*

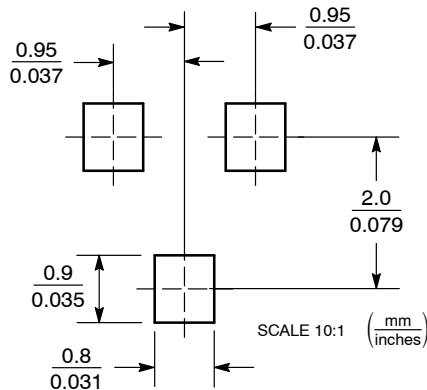

*For additional information on our Pb-Free strategy and soldering details, please download the ON Semiconductor Soldering and Mounting Techniques Reference Manual, SOLDERRM/D.

ON Semiconductor and are registered trademarks of Semiconductor Components Industries, LLC (SCILLC). SCILLC reserves the right to make changes without further notice to any products herein. SCILLC makes no warranty, representation or guarantee regarding the suitability of its products for any particular purpose, nor does SCILLC assume any liability arising out of the application or use of any product or circuit, and specifically disclaims any and all liability, including without limitation special, consequential or incidental damages. "Typical" parameters which may be provided in SCILLC data sheets and/or specifications can and do vary in different applications and actual performance may vary over time. All operating parameters, including "Typicals" must be validated for each customer application by customer's technical experts. SCILLC does not convey any license under its patent rights nor the rights of others. SCILLC products are not designed, intended, or authorized for use as components in systems intended for surgical implant into the body, or other applications intended to support or sustain life, or for any other application in which the failure of the SCILLC product could create a situation where personal injury or death may occur. Should Buyer purchase or use SCILLC products for any such unintended or unauthorized application, Buyer shall indemnify and hold SCILLC and its officers, employees, subsidiaries, affiliates, and distributors harmless against all claims, costs, damages, and expenses, and reasonable attorney fees arising out of, directly or indirectly, any claim of personal injury or death associated with such unintended or unauthorized use, even if such claim alleges that SCILLC was negligent regarding the design or manufacture of the part. SCILLC is an Equal Opportunity/Affirmative Action Employer. This literature is subject to all applicable copyright laws and is not for resale in any manner.

PUBLICATION ORDERING INFORMATION

LITERATURE FULFILLMENT:

Literature Distribution Center for ON Semiconductor
P.O. Box 5163, Denver, Colorado 80217 USA
Phone: 303-675-2175 or 800-344-3860 Toll Free USA/Canada
Fax: 303-675-2176 or 800-344-3867 Toll Free USA/Canada
Email: orderlit@onsemi.com

N. American Technical Support: 800-282-9855 Toll Free
USA/Canada
Europe, Middle East and Africa Technical Support:
Phone: 421 33 790 2910
Japan Customer Focus Center
Phone: 81-3-5817-1050

ON Semiconductor Website: www.onsemi.com

Order Literature: <http://www.onsemi.com/orderlit>

For additional information, please contact your local Sales Representative



Компания «ЭлектроПласт» предлагает заключение долгосрочных отношений при поставках импортных электронных компонентов на взаимовыгодных условиях!

Наши преимущества:

- Оперативные поставки широкого спектра электронных компонентов отечественного и импортного производства напрямую от производителей и с крупнейших мировых складов;
- Поставка более 17-ти миллионов наименований электронных компонентов;
- Поставка сложных, дефицитных, либо снятых с производства позиций;
- Оперативные сроки поставки под заказ (от 5 рабочих дней);
- Экспресс доставка в любую точку России;
- Техническая поддержка проекта, помощь в подборе аналогов, поставка прототипов;
- Система менеджмента качества сертифицирована по Международному стандарту ISO 9001;
- Лицензия ФСБ на осуществление работ с использованием сведений, составляющих государственную тайну;
- Поставка специализированных компонентов (Xilinx, Altera, Analog Devices, Intersil, Interpoint, Microsemi, Aeroflex, Peregrine, Syfer, Eurofarad, Texas Instrument, Miteq, Cobham, E2V, MA-COM, Hittite, Mini-Circuits, General Dynamics и др.);

Помимо этого, одним из направлений компании «ЭлектроПласт» является направление «Источники питания». Мы предлагаем Вам помощь Конструкторского отдела:

- Подбор оптимального решения, техническое обоснование при выборе компонента;
- Подбор аналогов;
- Консультации по применению компонента;
- Поставка образцов и прототипов;
- Техническая поддержка проекта;
- Защита от снятия компонента с производства.



Как с нами связаться

Телефон: 8 (812) 309 58 32 (многоканальный)

Факс: 8 (812) 320-02-42

Электронная почта: org@eplast1.ru

Адрес: 198099, г. Санкт-Петербург, ул. Калинина, дом 2, корпус 4, литера А.