

# GW PUSRA1.PM

## OSCONIQ® P 3737 (2W)

High-power LED with high performance, superior robustness and long lifetime.

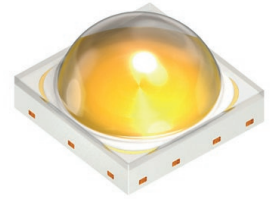

### Applications

- Architecture
- Area Lights
- Highbay Industrial
- Street, Tunnel and Outdoor

### Features:

- Package: New SMD epoxy package with silicone lens
- Typ. Radiation: 120° (Lambertian emitter)
- Corrosion Robustness Class: 3B
- Color temperature: 3000K - 6500K
- CRI: 70 (min.), 72 (typ.)
- ESD: 8 kV acc. to ANSI/ESDA/JEDEC JS-001 (HBM, Class 3B)
- Luminous Flux: typ. 333 lm @ 5000 K, 85 °C
- Luminous efficacy: typ. 169 lm/W @ 5000 K, 85 °C

## Ordering Information

| Type                     | Color temperature | Luminous Flux <sup>1)</sup><br>$I_F = 700 \text{ mA}$<br>$\Phi_v$ | Ordering Code |
|--------------------------|-------------------|---|---------------|
| GW PUSRA1.PM-N3N9-XX57-1 | 3000 K            | 300 ... 370 lm  | Q65112A8656   |
| GW PUSRA1.PM-N3N5-XX56-1 | 3500 K            | 300 ... 330 lm  | Q65112A7906   |
| GW PUSRA1.PM-N4P1-XX56-1 | 3500 K            | 310 ... 380 lm  | Q65112A8658   |
| GW PUSRA1.PM-N4P1-XX55-1 | 4000 K            | 310 ... 380 lm  | Q65112A8812   |
| GW PUSRA1.PM-N4P1-XX54-1 | 4500 K            | 310 ... 380 lm  | Q65112A8651   |
| GW PUSRA1.PM-N4N6-XX53-1 | 5000 K            | 310 ... 340 lm  | Q65112A6202   |
| GW PUSRA1.PM-N5P2-XX53-1 | 5000 K            | 320 ... 390 lm  | Q65112A8645   |
| GW PUSRA1.PM-N4N6-XX52-1 | 5700 K            | 310 ... 340 lm  | Q65112A6200   |
| GW PUSRA1.PM-N5P2-XX52-1 | 5700 K            | 320 ... 390 lm  | Q65112A8647   |
| GW PUSRA1.PM-N4P1-XX51-1 | 6500 K            | 310 ... 380 lm  | Q65112A8643   |

## Maximum Ratings

| Parameter  | Symbol    |              | Values                             |
|--|-----------|--------------|------------------------------------|
| Operating Temperature  | $T_{op}$  | min.<br>max. | -40 °C<br>125 °C                   |
| Storage Temperature  | $T_{stg}$ | min.<br>max. | -40 °C<br>125 °C                   |
| Junction Temperature   | $T_j$     | max.         | 135 °C                             |
| Forward Current<br>$T_j = 85\text{ °C}$  | $I_F$     | min.<br>max. | 100 mA<br>1500 mA                  |
| Surge Current<br>$t \leq 10\ \mu\text{s}$ ; $D = 0.005$ ; $T_j = 85\text{ °C}$ | $I_{FS}$  | max.         | 2000 mA                            |
| Reverse voltage <sup>2)</sup>  | $V_R$     |              | Not designed for reverse operation |
| ESD withstand voltage<br>acc. to ANSI/ESDA/JEDEC JS-001 (HBM, Class 3B)        | $V_{ESD}$ |              | 8 kV                               |

## Characteristics

$I_F = 700 \text{ mA}$ ;  $T_J = 85 \text{ °C}$

| Parameter  | Symbol                   |                      | Values                                   |
|--|--------------------------|----------------------|--|
| Viewing angle at 50% $I_V$   | $2\phi$                  | typ.                 | 120 °                                    |
| Forward Voltage <sup>3)</sup>  | $V_F$                    | min.<br>typ.<br>max. | 2.70 V<br>2.80 V<br>3.20 V               |
| Reverse current <sup>2)</sup>  | $I_R$                    |                      | Not designed<br>for reverse<br>operation |
| Color Rendering Index <sup>4)</sup><br>(3000K - 6500K)                                 | CRI                      | min.<br>typ.         | 70<br>72                                 |
| Electrical thermal resistance junction/solderpoint<br>with efficiency $\eta_e = 43 \%$ | $R_{thJS \text{ elec.}}$ | typ.                 | 2.8 K / W                                |

## Brightness Groups

| Group | Luminous Flux <sup>1)</sup><br>$I_F = 700 \text{ mA}$<br>min.<br>$\Phi_V$ | Luminous Flux <sup>1)</sup><br>$I_F = 700 \text{ mA}$<br>max.<br>$\Phi_V$ |
|-------|---|---|
| N3    | 300 lm  | 310 lm  |
| N4    | 310 lm  | 320 lm  |
| N5    | 320 lm  | 330 lm  |
| N6    | 330 lm  | 340 lm  |
| N7    | 340 lm  | 350 lm  |
| N8    | 350 lm  | 360 lm  |
| N9    | 360 lm  | 370 lm  |
| P1    | 370 lm  | 380 lm  |
| P2    | 380 lm  | 390 lm  |

## Forward Voltage Groups

| Group | Forward Voltage <sup>3)</sup><br>min.<br>$V_F$ | Forward Voltage <sup>3)</sup><br>max.<br>$V_F$ |
|-------|--|--|
| K2    | 2.70 V   | 2.80 V   |
| L1    | 2.80 V   | 2.90 V   |
| L2    | 2.90 V   | 3.00 V   |
| M1    | 3.00 V   | 3.10 V   |
| M2    | 3.10 V   | 3.20 V   |

### Chromaticity Coordinate Groups 5)



---

## Chromaticity Coordinate Groups

| CCT    | Center<br>Cx | Center<br>Cy | 3step<br>a | 3step<br>b | 5step<br>a | 5step<br>b | Ø    |
|--------|--------------|--------------|------------|------------|------------|------------|------|
| 3000 K | 0.4339       | 0.4032       | 0.0086     | 0.0042     | 0.0142     | 0.0069     | 53.7 |
| 3500 K | 0.4077       | 0.3929       | 0.0093     | 0.0042     | 0.0155     | 0.0069     | 53.9 |
| 4000 K | 0.3818       | 0.3796       | 0.0094     | 0.0041     | 0.0157     | 0.0068     | 53.4 |
| 4500 K | 0.3613       | 0.3669       | 0.0089     | 0.0038     | 0.0148     | 0.0063     | 57   |
| 5000 K | 0.3446       | 0.3551       | 0.0081     | 0.0035     | 0.0135     | 0.0059     | 59.8 |
| 5700 K | 0.3287       | 0.3425       | 0.0072     | 0.0032     | 0.0119     | 0.0052     | 58.8 |
| 6500 K | 0.3123       | 0.3282       | 0.0066     | 0.0027     | 0.0110     | 0.0045     | 58.1 |

| CCT    | Group | 1      |        | 2      |        | 3      |        | 4      |        | 5      |        |
|--------|-------|--------|--------|--------|--------|--------|--------|--------|--------|--------|--------|
|        |       | Cx     | Cy     | Cx     | Cy     | Cx     | Cy     | Cx     | Cy     | Cx     | Cy     |
| 3000 K | A     | 0.4418 | 0.4211 | 0.4302 | 0.4171 | 0.4226 | 0.3995 | 0.4246 | 0.4002 | 0.4393 | 0.4153 |
|        | B     | 0.4418 | 0.4211 | 0.4561 | 0.4259 | 0.4465 | 0.4073 | 0.4432 | 0.4062 | 0.4393 | 0.4153 |
|        | C     | 0.4465 | 0.4073 | 0.4372 | 0.3892 | 0.4261 | 0.3856 | 0.4285 | 0.3911 | 0.4432 | 0.4062 |
|        | D     | 0.4285 | 0.3911 | 0.4246 | 0.4002 | 0.4226 | 0.3995 | 0.4149 | 0.3819 | 0.4261 | 0.3856 |
|        | E     | 0.4393 | 0.4153 | 0.4246 | 0.4002 | 0.4283 | 0.4014 | 0.4371 | 0.4105 |        |        |
|        | F     | 0.4393 | 0.4153 | 0.4432 | 0.4062 | 0.4395 | 0.4050 | 0.4371 | 0.4105 |        |        |
|        | G     | 0.4432 | 0.4062 | 0.4285 | 0.3911 | 0.4307 | 0.3960 | 0.4395 | 0.4050 |        |        |
|        | H     | 0.4307 | 0.3960 | 0.4283 | 0.4014 | 0.4246 | 0.4002 | 0.4285 | 0.3911 |        |        |
| 3500 K | A     | 0.4131 | 0.4093 | 0.4003 | 0.4034 | 0.3949 | 0.3871 | 0.3977 | 0.3883 | 0.4118 | 0.4054 |
|        | B     | 0.4131 | 0.4093 | 0.4302 | 0.4171 | 0.4227 | 0.3997 | 0.4177 | 0.3975 | 0.4118 | 0.4054 |
|        | C     | 0.4227 | 0.3997 | 0.4149 | 0.3819 | 0.4022 | 0.3763 | 0.4036 | 0.3804 | 0.4177 | 0.3975 |
|        | D     | 0.4036 | 0.3804 | 0.3977 | 0.3883 | 0.3949 | 0.3871 | 0.3895 | 0.3707 | 0.4022 | 0.3763 |
|        | E     | 0.4118 | 0.4054 | 0.3977 | 0.3883 | 0.4017 | 0.3902 | 0.4102 | 0.4004 |        |        |
|        | F     | 0.4118 | 0.4054 | 0.4177 | 0.3975 | 0.4137 | 0.3957 | 0.4102 | 0.4004 |        |        |
|        | G     | 0.4177 | 0.3975 | 0.4036 | 0.3804 | 0.4052 | 0.3854 | 0.4137 | 0.3957 |        |        |
|        | H     | 0.4052 | 0.3854 | 0.4017 | 0.3902 | 0.3977 | 0.3883 | 0.4036 | 0.3804 |        |        |
| 4000 K | A     | 0.3853 | 0.3947 | 0.3737 | 0.3879 | 0.3704 | 0.3731 | 0.3714 | 0.3737 | 0.3845 | 0.3913 |
|        | B     | 0.3853 | 0.3947 | 0.4003 | 0.4034 | 0.3949 | 0.3871 | 0.3922 | 0.3855 | 0.3845 | 0.3913 |
|        | C     | 0.3949 | 0.3871 | 0.3895 | 0.3707 | 0.3783 | 0.3645 | 0.3791 | 0.3679 | 0.3922 | 0.3855 |
|        | D     | 0.3791 | 0.3679 | 0.3714 | 0.3737 | 0.3704 | 0.3731 | 0.3671 | 0.3583 | 0.3783 | 0.3645 |
|        | E     | 0.3845 | 0.3913 | 0.3714 | 0.3737 | 0.3756 | 0.3760 | 0.3834 | 0.3866 |        |        |
|        | F     | 0.3845 | 0.3913 | 0.3922 | 0.3855 | 0.3880 | 0.3832 | 0.3834 | 0.3866 |        |        |
|        | G     | 0.3922 | 0.3855 | 0.3791 | 0.3679 | 0.3802 | 0.3726 | 0.3880 | 0.3832 |        |        |
|        | H     | 0.3802 | 0.3726 | 0.3756 | 0.3760 | 0.3714 | 0.3737 | 0.3791 | 0.3679 |        |        |
| 4500 K | A     | 0.3634 | 0.3809 | 0.3550 | 0.3752 | 0.3538 | 0.3664 | 0.3629 | 0.3779 |        |        |
|        | B     | 0.3634 | 0.3809 | 0.3737 | 0.3879 | 0.3709 | 0.3753 | 0.3629 | 0.3779 |        |        |
|        | C     | 0.3695 | 0.3690 | 0.3671 | 0.3583 | 0.3593 | 0.3532 | 0.3597 | 0.3559 |        |        |
|        | D     | 0.3597 | 0.3559 | 0.3524 | 0.3555 | 0.3514 | 0.3480 | 0.3593 | 0.3532 |        |        |
|        | E     | 0.3629 | 0.3779 | 0.3538 | 0.3664 | 0.3532 | 0.3616 | 0.3557 | 0.3632 | 0.3623 | 0.3735 |
|        | F     | 0.3629 | 0.3779 | 0.3709 | 0.3753 | 0.3703 | 0.3728 | 0.3669 | 0.3706 | 0.3623 | 0.3735 |
|        | G     | 0.3703 | 0.3728 | 0.3695 | 0.3690 | 0.3597 | 0.3559 | 0.3603 | 0.3603 | 0.3669 | 0.3706 |
|        | H     | 0.3603 | 0.3603 | 0.3557 | 0.3632 | 0.3532 | 0.3616 | 0.3524 | 0.3555 | 0.3597 | 0.3559 |



|        |   |        |        |        |        |        |        |        |        |        |        |
|--------|---|--------|--------|--------|--------|--------|--------|--------|--------|--------|--------|
| 5000 K | A | 0.3452 | 0.3678 | 0.3375 | 0.3619 | 0.3372 | 0.3528 | 0.3451 | 0.3648 |        |        |
|        | B | 0.3452 | 0.3678 | 0.3550 | 0.3752 | 0.3532 | 0.3614 | 0.3530 | 0.3612 | 0.3451 | 0.3648 |
|        | C | 0.3532 | 0.3614 | 0.3514 | 0.3480 | 0.3440 | 0.3426 | 0.3441 | 0.3454 | 0.3530 | 0.3612 |
|        | D | 0.3441 | 0.3454 | 0.3369 | 0.3445 | 0.3366 | 0.3372 | 0.3440 | 0.3426 |        |        |
|        | E | 0.3451 | 0.3648 | 0.3372 | 0.3528 | 0.3371 | 0.3496 | 0.3396 | 0.3514 | 0.3449 | 0.3609 |
|        | F | 0.3451 | 0.3648 | 0.3530 | 0.3612 | 0.3496 | 0.3588 | 0.3449 | 0.3609 |        |        |
|        | G | 0.3530 | 0.3612 | 0.3441 | 0.3454 | 0.3443 | 0.3493 | 0.3496 | 0.3588 |        |        |
|        | H | 0.3443 | 0.3493 | 0.3396 | 0.3514 | 0.3371 | 0.3496 | 0.3369 | 0.3445 | 0.3441 | 0.3454 |
| 5700 K | A | 0.3280 | 0.3539 | 0.3205 | 0.3475 | 0.3212 | 0.3373 | 0.3283 | 0.3502 |        |        |
|        | B | 0.3280 | 0.3539 | 0.3375 | 0.3619 | 0.3370 | 0.3493 | 0.3363 | 0.3486 | 0.3283 | 0.3502 |
|        | C | 0.3370 | 0.3493 | 0.3366 | 0.3372 | 0.3294 | 0.3314 | 0.3291 | 0.3348 | 0.3363 | 0.3486 |
|        | D | 0.3291 | 0.3348 | 0.3215 | 0.3337 | 0.3221 | 0.3255 | 0.3294 | 0.3314 |        |        |
|        | E | 0.3283 | 0.3502 | 0.3212 | 0.3373 | 0.3213 | 0.3365 | 0.3242 | 0.3388 | 0.3284 | 0.3471 |
|        | F | 0.3283 | 0.3502 | 0.3363 | 0.3486 | 0.3332 | 0.3462 | 0.3284 | 0.3471 |        |        |
|        | G | 0.3363 | 0.3486 | 0.3291 | 0.3348 | 0.3290 | 0.3379 | 0.3332 | 0.3462 |        |        |
|        | H | 0.3291 | 0.3348 | 0.3215 | 0.3337 | 0.3213 | 0.3365 | 0.3242 | 0.3388 | 0.3290 | 0.3379 |
| 6500 K | A | 0.3102 | 0.3379 | 0.3027 | 0.3310 | 0.3047 | 0.3214 | 0.3054 | 0.3220 | 0.3110 | 0.3340 |
|        | B | 0.3102 | 0.3379 | 0.3205 | 0.3475 | 0.3213 | 0.3363 | 0.3192 | 0.3344 | 0.3110 | 0.3340 |
|        | C | 0.3213 | 0.3363 | 0.3221 | 0.3255 | 0.3144 | 0.3187 | 0.3136 | 0.3224 | 0.3192 | 0.3344 |
|        | D | 0.3136 | 0.3224 | 0.3054 | 0.3220 | 0.3047 | 0.3214 | 0.3067 | 0.3118 | 0.3144 | 0.3187 |
|        | E | 0.3110 | 0.3340 | 0.3054 | 0.3220 | 0.3082 | 0.3245 | 0.3115 | 0.3317 |        |        |
|        | F | 0.3110 | 0.3340 | 0.3192 | 0.3344 | 0.3165 | 0.3319 | 0.3115 | 0.3317 |        |        |
|        | G | 0.3192 | 0.3344 | 0.3136 | 0.3224 | 0.3131 | 0.3247 | 0.3165 | 0.3319 |        |        |
|        | H | 0.3136 | 0.3224 | 0.3054 | 0.3220 | 0.3082 | 0.3245 | 0.3131 | 0.3247 |        |        |

**Relative Spectral Emission** <sup>6)</sup>

$\Phi_{rel} = f(\lambda)$ ;  $I_F = 700 \text{ mA}$ ;  $T_J = 85 \text{ }^\circ\text{C}$

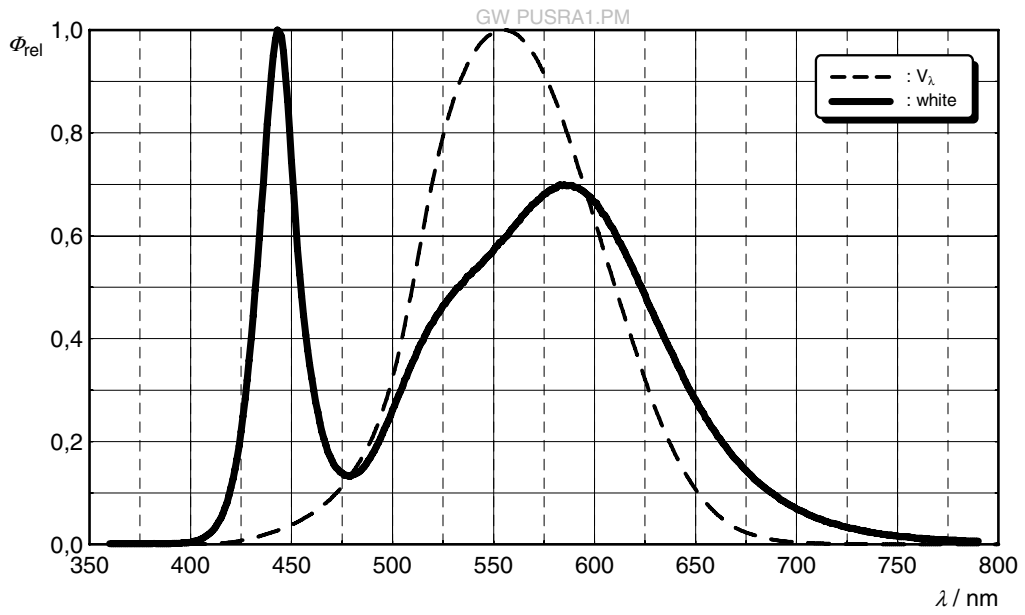

**Radiation Characteristics** <sup>6)</sup>

$I_{rel} = f(\phi)$ ;  $T_J = 85 \text{ }^\circ\text{C}$

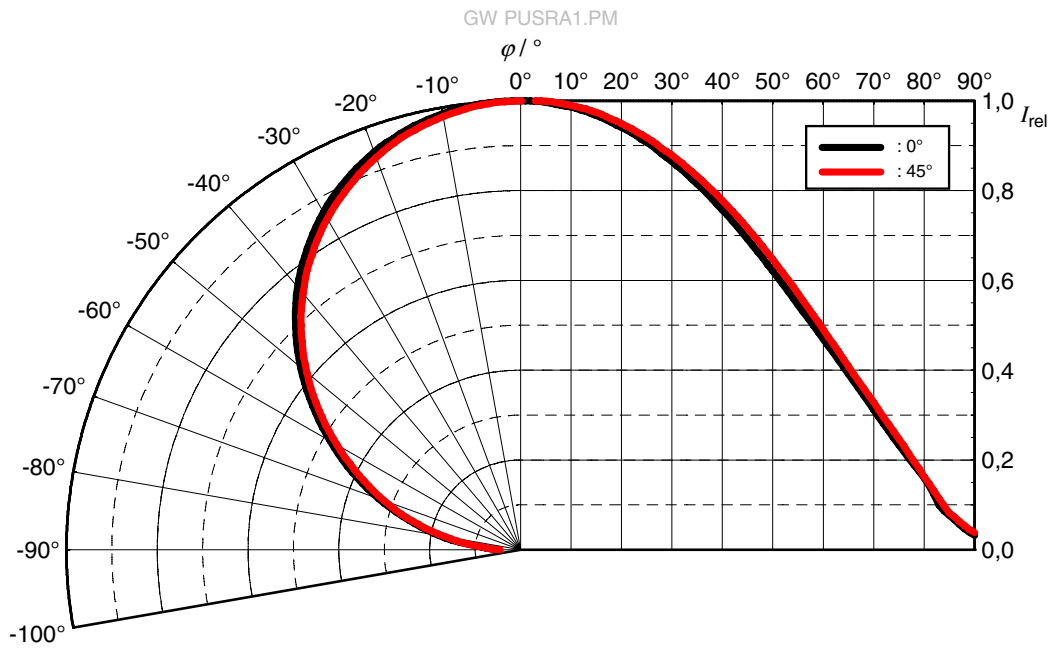

**Forward current** <sup>6)</sup>

$I_F = f(V_F); T_J = 85 \text{ }^\circ\text{C}$

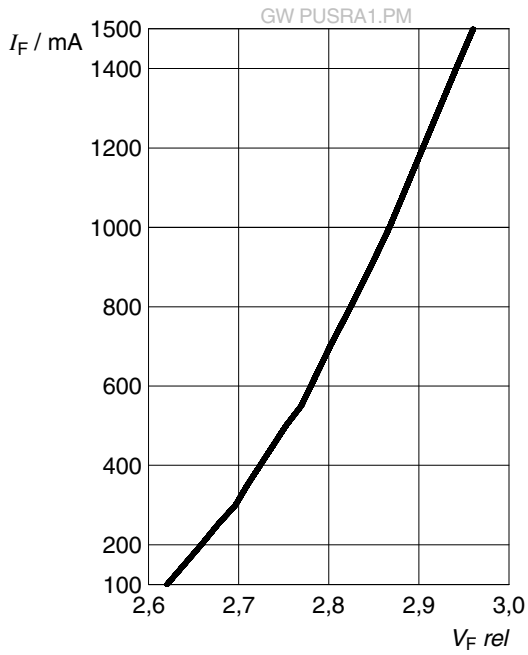

**Relative Luminous Flux** <sup>6), 7)</sup>

$\Phi_V / \Phi_V(700 \text{ mA}) = f(I_F); T_J = 85 \text{ }^\circ\text{C}$

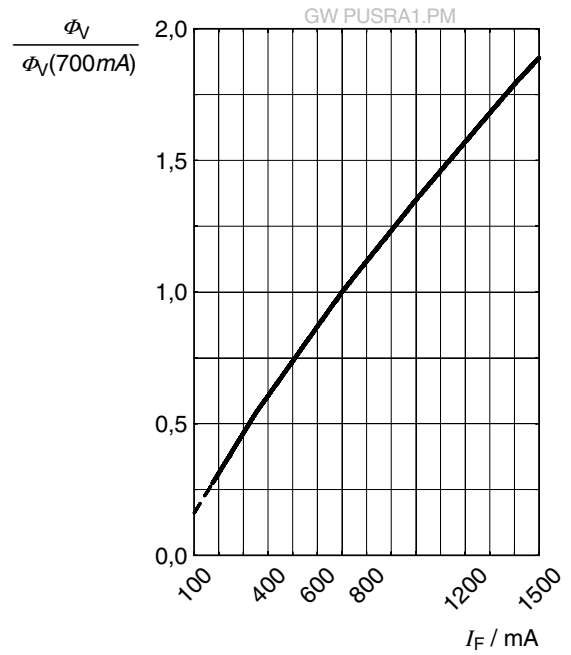

**Chromaticity Coordinate Shift** <sup>6)</sup>

$\Delta Cx, \Delta Cy = f(I_F); T_J = 85 \text{ }^\circ\text{C}$

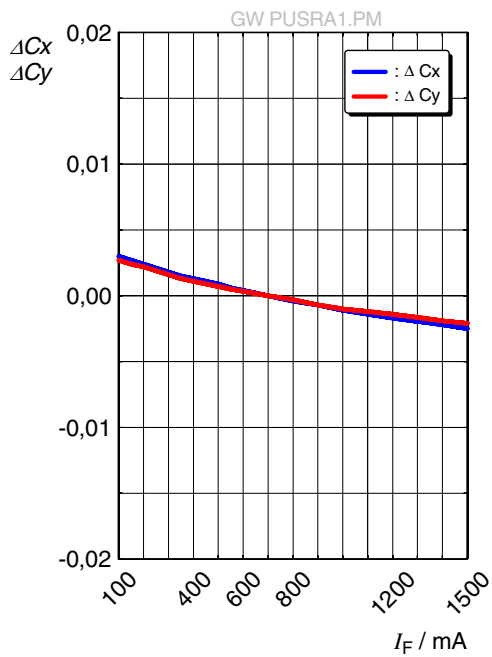

**Forward Voltage** <sup>6)</sup>

$$\Delta V_F = V_F - V_F(85^\circ\text{C}) = f(T_j); I_F = 700\text{ mA}$$

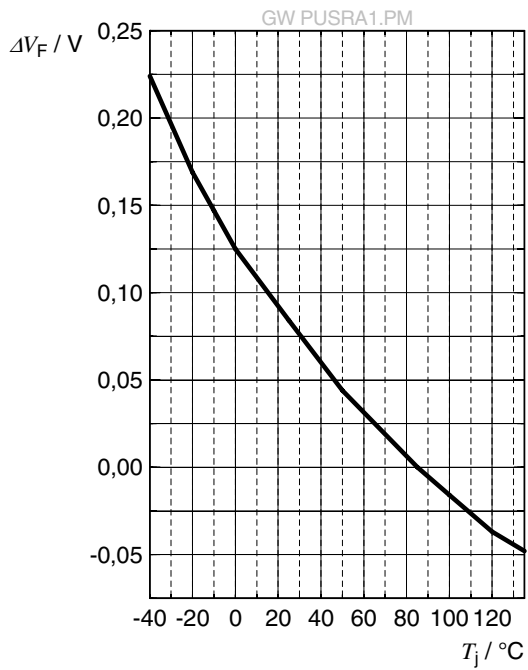

**Relative Luminous Flux** <sup>6)</sup>

$$\Phi_V / \Phi_V(85^\circ\text{C}) = f(T_j); I_F = 700\text{ mA}$$

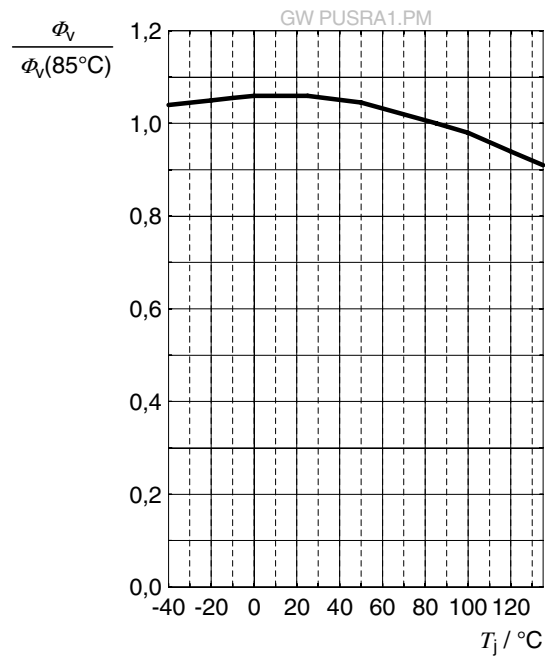

**Chromaticity Coordinate Shift** <sup>6)</sup>

$$\Delta C_x, \Delta C_y = f(T_j); I_F = 700\text{ mA}$$

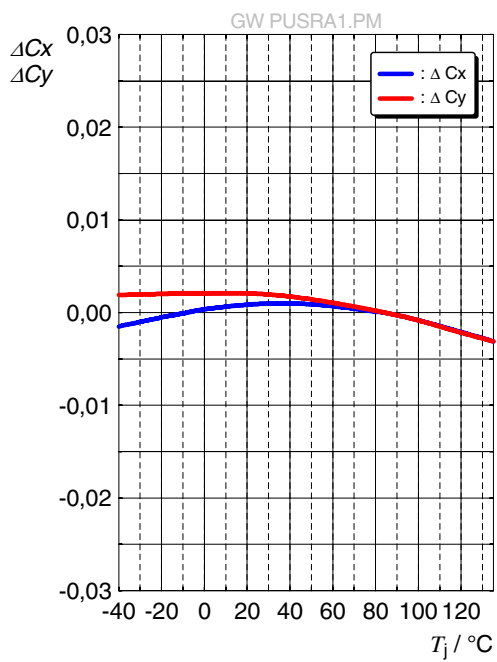

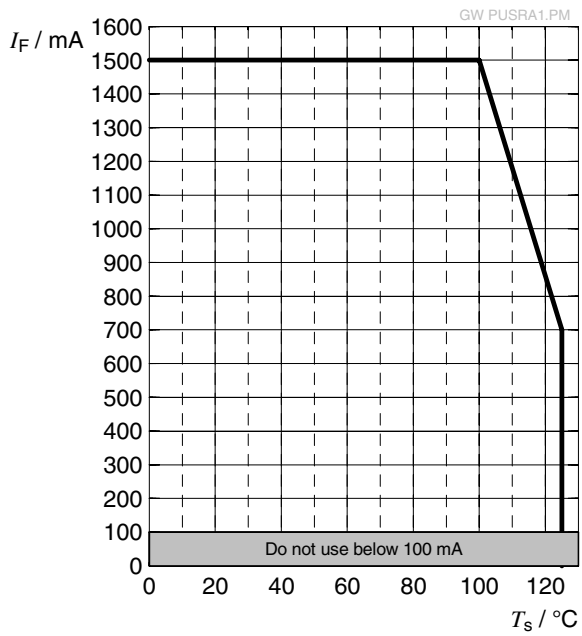

## Max. Permissible Forward Current

$$I_F = f(T)$$

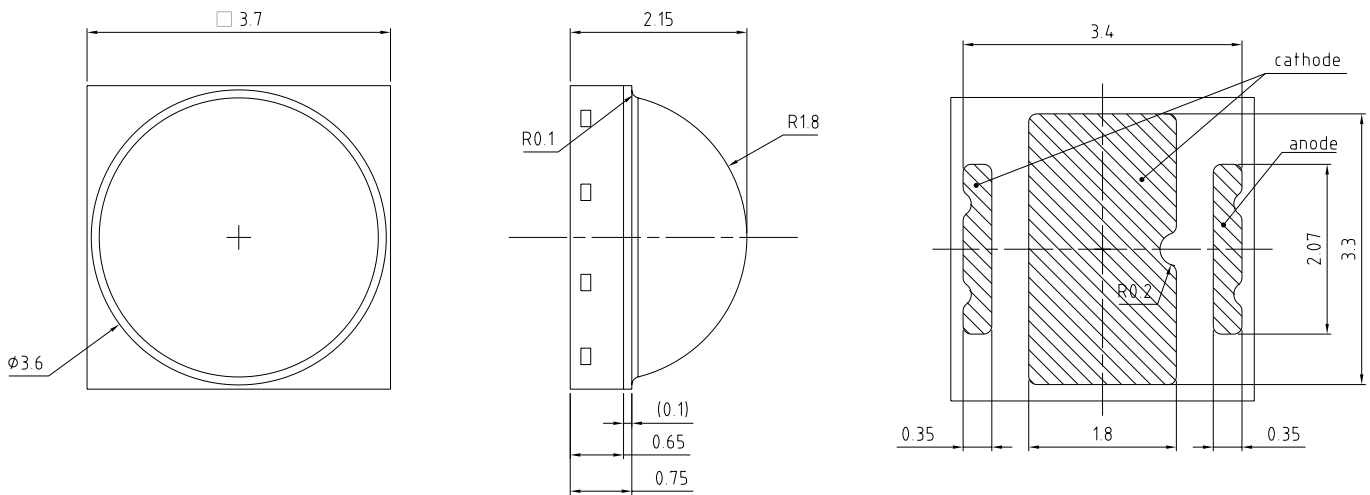

**Dimensional Drawing** 8)



General tolerance  $\pm 0.1$   
 Lead finish Au 

C67062-A0172-A1-04

**Further Information:**

**Approximate Weight:** 43.0 mg

**Package marking:** Cathode

**Corrosion test:** Class: 3B  
 Test condition: 40°C / 90 % RH / 15 ppm H<sub>2</sub>S / 14 days (stricter than IEC 60068-2-43)

**ESD advice:** The device is protected by ESD device which is connected in parallel to the Chip.

Recommended Solder Pad 8)

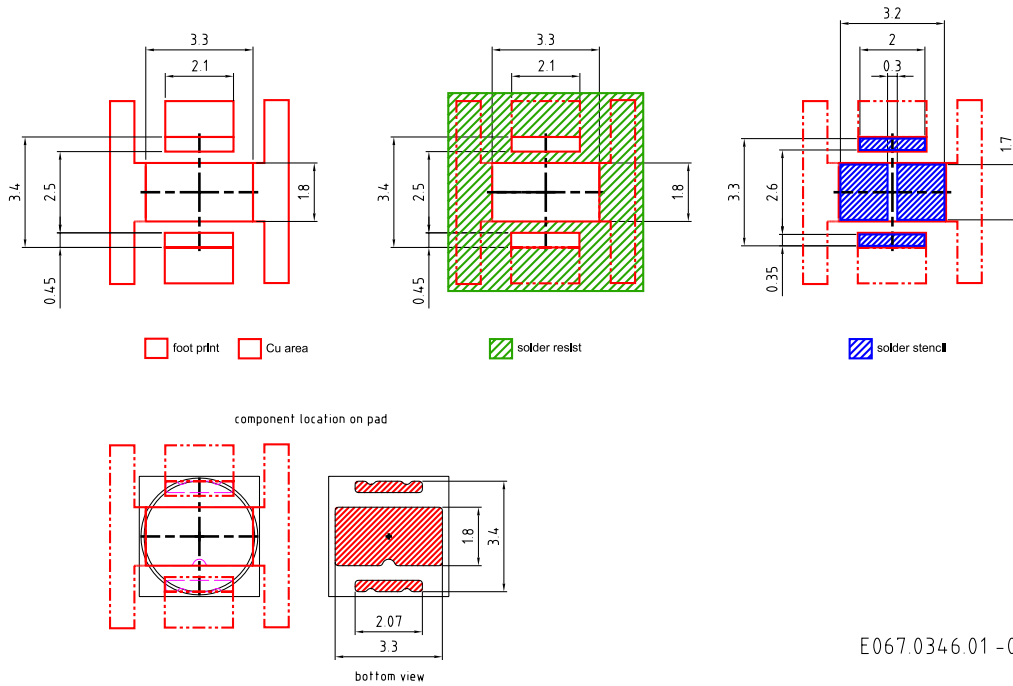

E067.0346.01 -05

For superior solder joint connectivity results we recommend soldering under standard nitrogen atmosphere. Package not suitable for ultra sonic cleaning.

## Reflow Soldering Profile

Product complies to MSL Level 2 acc. to JEDEC J-STD-020E

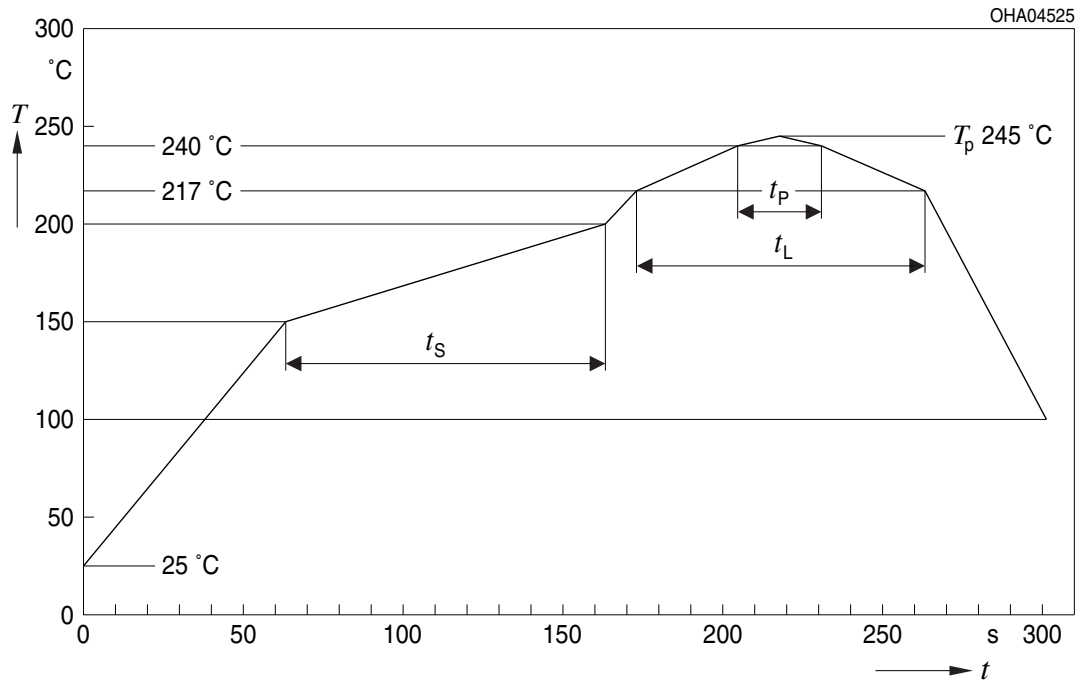

| Profile Feature  | Symbol | Pb-Free (SnAgCu) Assembly |                |         | Unit |
|--|--------|---------------------------|----------------|---------|------|
|  |        | Minimum                   | Recommendation | Maximum |      |
| Ramp-up rate to preheat <sup>*)</sup><br>25 °C to 150 °C       |        |                           | 2              | 3       | K/s  |
| Time $t_s$<br>$T_{Smin}$ to $T_{Smax}$                         | $t_s$  | 60                        | 100            | 120     | s    |
| Ramp-up rate to peak <sup>*)</sup><br>$T_{Smax}$ to $T_p$      |        |                           | 2              | 3       | K/s  |
| Liquidus temperature   | $T_L$  |                           | 217            |         | °C   |
| Time above liquidus temperature                                | $t_L$  |                           | 80             | 100     | s    |
| Peak temperature   | $T_p$  |                           | 245            | 260     | °C   |
| Time within 5 °C of the specified peak temperature $T_p - 5$ K | $t_p$  | 10                        | 20             | 30      | s    |
| Ramp-down rate*<br>$T_p$ to 100 °C                             |        |                           | 3              | 6       | K/s  |
| Time<br>25 °C to $T_p$   |        |                           |                | 480     | s    |

All temperatures refer to the center of the package, measured on the top of the component  
 \*) slope calculation  $DT/Dt$ :  $Dt$  max. 5 s; fulfillment for the whole T-range



Taping <sup>8)</sup>

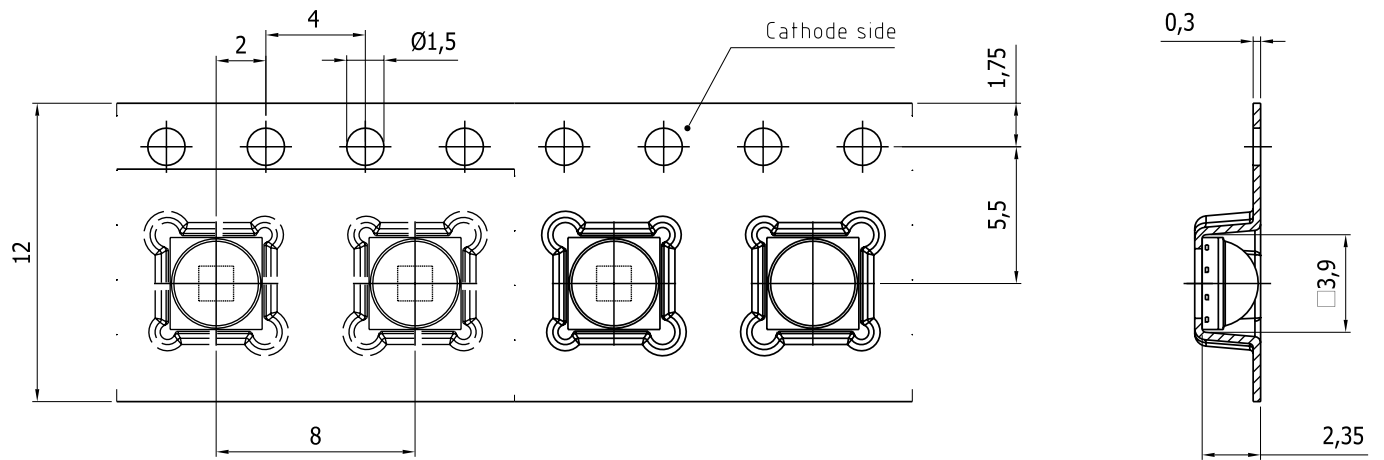

C67062-A0172-B11-01

**Tape and Reel** <sup>9)</sup>



**Reel Dimensions**

| A      | W                   | N <sub>min</sub> | W <sub>1</sub> | W <sub>2max</sub> | Pieces per PU |
|--------|---------------------|------------------|----------------|-------------------|---------------|
| 180 mm | 12 + 0.3 / - 0.1 mm | 60 mm            | 12.4 + 2 mm    | 18.4 mm           | 600           |

### Barcode-Product-Label (BPL)

**OSRAM Opto Semiconductors** LX XXXX BIN1: XX-XX-X-XXX-X

RoHS Compliant

(6P) BATCH NO: 1234567890

(1T) LOT NO: 1234567890 (9D) D/C: 1234

(X) PROD NO: 123456789 (Q) QTY: 9999 (G) GROUP: XX-XX-X-X

ML Temp ST  
X XXX °C X

Pack: RXX  
DEMY XXX  
X\_X123\_1234.1234 X



The diagram shows a rectangular label with rounded corners. It contains the OSRAM logo and product name at the top left. To the right are fields for 'LX XXXX' and 'BIN1: XX-XX-X-XXX-X'. Below the logo is the text 'RoHS Compliant'. The label features three horizontal barcode sections. The first is labeled '(6P) BATCH NO: 1234567890'. The second is labeled '(1T) LOT NO: 1234567890' and '(9D) D/C: 1234'. The third is labeled '(X) PROD NO: 123456789 (Q) QTY: 9999 (G) GROUP: XX-XX-X-X'. To the right of the second barcode is a circular icon with a crossed-out rain cloud and the text 'ML Temp ST X XXX °C X'. Below this is a square QR code. At the bottom right of the label area is the text 'Pack: RXX', 'DEMY XXX', and 'X\_X123\_1234.1234 X'. A large 'EXAMPLE' watermark is overlaid diagonally across the label.

OHA04563

### Dry Packing Process and Materials <sup>8)</sup>



OHA00539

Moisture-sensitive product is packed in a dry bag containing desiccant and a humidity card according JEDEC-STD-033.

## Notes

The evaluation of eye safety occurs according to the standard IEC 62471:2006 (photo biological safety of lamps and lamp systems). Within the risk grouping system of this IEC standard, the device specified in this data sheet falls into the class **moderate risk (exposure time 0.25 s)**. Under real circumstances (for exposure time, conditions of the eye pupils, observation distance), it is assumed that no endangerment to the eye exists from these devices. As a matter of principle, however, it should be mentioned that intense light sources have a high secondary exposure potential due to their blinding effect. When looking at bright light sources (e.g. headlights), temporary reduction in visual acuity and afterimages can occur, leading to irritation, annoyance, visual impairment, and even accidents, depending on the situation.

Subcomponents of this device contain, in addition to other substances, metal filled materials including silver. Metal filled materials can be affected by environments that contain traces of aggressive substances. Therefore, we recommend that customers minimize device exposure to aggressive substances during storage, production, and use. Devices that showed visible discoloration when tested using the described tests above did show no performance deviations within failure limits during the stated test duration. Respective failure limits are described in the IEC60810.

This device is designed for specific/recommended applications only. Please consult OSRAM Opto Semiconductors Sales Staff in advance for detailed information on other non-recommended applications (e.g. automotive).

Change management for this component is aligned with the requirements of the lighting market.

For further application related information please visit [www.osram-os.com/appnotes](http://www.osram-os.com/appnotes)

## Disclaimer

### **Attention please!**

The information describes the type of component and shall not be considered as assured characteristics. Terms of delivery and rights to change design reserved. Due to technical requirements components may contain dangerous substances.

For information on the types in question please contact our Sales Organization.

If printed or downloaded, please find the latest version on the OSRAM OS website.

### **Packing**

Please use the recycling operators known to you. We can also help you – get in touch with your nearest sales office. By agreement we will take packing material back, if it is sorted. You must bear the costs of transport. For packing material that is returned to us unsorted or which we are not obliged to accept, we shall have to invoice you for any costs incurred.

### **Product and functional safety devices/applications or medical devices/applications**

OSRAM OS components are not developed, constructed or tested for the application as safety relevant component or for the application in medical devices.

OSRAM OS products are not qualified at module and system level for such application.

In case buyer – or customer supplied by buyer – considers using OSRAM OS components in product safety devices/applications or medical devices/applications, buyer and/or customer has to inform the local sales partner of OSRAM OS immediately and OSRAM OS and buyer and /or customer will analyze and coordinate the customer-specific request between OSRAM OS and buyer and/or customer.

---

## Glossary

- 1) **Brightness:** Brightness values are measured during a current pulse of typically 10 ms, with a tolerance of +/- 7%.
- 2) **Reverse Operation:** Not designed for reverse operation. Continuous reverse operation can cause migration and damage of the device.
- 3) **Forward Voltage:** The Forward voltage is measured during a current pulse duration of typically 1 ms with a tolerance of  $\pm 0.05V$ .
- 4) **Color reproduction index:** Color reproduction index values (CRI-RA) are measured during a current pulse of typically 10 ms and with a tolerance of  $\pm 2$ .
- 5) **Chromaticity coordinate groups:** Chromaticity coordinates are measured during a current pulse of typically 25 ms, with an internal reproducibility of  $\pm 0.005$  and an expanded uncertainty of  $\pm 0.01$  (acc. to GUM with a coverage factor of  $k = 3$ ).
- 6) **Typical Values:** Due to the special conditions of the manufacturing processes of semiconductor devices, the typical data or calculated correlations of technical parameters can only reflect statistical figures. These do not necessarily correspond to the actual parameters of each single product, which could differ from the typical data and calculated correlations or the typical characteristic line. If requested, e.g. because of technical improvements, these typ. data will be changed without any further notice.
- 7) **Characteristic curve:** In the range where the line of the graph is broken, you must expect higher differences between single devices within one packing unit.
- 8) **Tolerance of Measure:** Unless otherwise noted in drawing, tolerances are specified with  $\pm 0.1$  and dimensions are specified in mm.
- 9) **Tape and Reel:** All dimensions and tolerances are specified acc. IEC 60286-3 and specified in mm.

---

## Revision History

| Version | Date       | Change   |
|---------|------------|--|
| 1.6     | 2019-01-18 | Maximum Ratings<br>Electro - Optical Characteristics (Diagrams)<br>Derating (Diagrams)   |
| 1.7     | 2019-03-22 | Electro - Optical Characteristics (Diagrams)   |
| 1.8     | 2019-05-03 | Ordering Information<br>Disclaimer   |
| 1.9     | 2019-10-14 | Ordering Information<br>Dimensions of Transportation Box<br>Schematic Transportation Box |

Published by OSRAM Opto Semiconductors GmbH EU RoHS and China RoHS compliant product  
Leibnizstraße 4, D-93055 Regensburg  
www.osram-os.com © All Rights Reserved.



此产品符合欧盟 RoHS 指令的要求；  
按照中国的相关法规和标准，不含有毒有害物质或元素。





Компания «ЭлектроПласт» предлагает заключение долгосрочных отношений при поставках импортных электронных компонентов на взаимовыгодных условиях!

Наши преимущества:

- Оперативные поставки широкого спектра электронных компонентов отечественного и импортного производства напрямую от производителей и с крупнейших мировых складов;
- Поставка более 17-ти миллионов наименований электронных компонентов;
- Поставка сложных, дефицитных, либо снятых с производства позиций;
- Оперативные сроки поставки под заказ (от 5 рабочих дней);
- Экспресс доставка в любую точку России;
- Техническая поддержка проекта, помощь в подборе аналогов, поставка прототипов;
- Система менеджмента качества сертифицирована по Международному стандарту ISO 9001;
- Лицензия ФСБ на осуществление работ с использованием сведений, составляющих государственную тайну;
- Поставка специализированных компонентов (Xilinx, Altera, Analog Devices, Intersil, Interpoint, Microsemi, Aeroflex, Peregrine, Syfer, Eurofarad, Texas Instrument, Miteq, Cobham, E2V, MA-COM, Hittite, Mini-Circuits, General Dynamics и др.);

Помимо этого, одним из направлений компании «ЭлектроПласт» является направление «Источники питания». Мы предлагаем Вам помощь Конструкторского отдела:

- Подбор оптимального решения, техническое обоснование при выборе компонента;
- Подбор аналогов;
- Консультации по применению компонента;
- Поставка образцов и прототипов;
- Техническая поддержка проекта;
- Защита от снятия компонента с производства.



#### Как с нами связаться

**Телефон:** 8 (812) 309 58 32 (многоканальный)

**Факс:** 8 (812) 320-02-42

**Электронная почта:** [org@eplast1.ru](mailto:org@eplast1.ru)

**Адрес:** 198099, г. Санкт-Петербург, ул. Калинина, дом 2, корпус 4, литера А.