

Cree® XLamp® CXA1304 LED



PRODUCT DESCRIPTION

The XLamp CXA1304 LED array expands Cree’s family of high-flux, multi-die arrays in a smaller, easy-to-use platform. With XLamp lighting-class reliability, the CXA1304’s small, uniform emitting surface enables both directional and non-directional lighting applications including lamp retrofit and luminaire designs. Available in 2-step and 4-step color consistency, and featuring a 6-mm optical source, the CXA1304 brings new levels of flux and efficacy to this form factor.

FEATURES

- Available in ANSI white bins as well as 4-step and 2-step EasyWhite® bins at 2700 K, 3000 K, 3500 K, 4000 K and 5000 K CCT
- Available in ANSI white bins as well as 4-step EasyWhite bins at 5700 K and 6500 K CCT
- Available in 70-, 80-, 90- and 93-minimum CRI options
- Forward voltage options: 9 V & 37 V
- 85 °C binning and characterization
- Maximum drive current: 1000 mA (9 V), 250 mA (37 V)
- 115° viewing angle, uniform chromaticity profile
- Top-side solder connections
- Thermocouple attach point
- NEMA SSL-3 2011 standard flux bins
- RoHS- and REACH-compliant
- UL-recognized component (E349212)

TABLE OF CONTENTS

Characteristics	2
Operating Limits.....	3
Flux Characteristics, EasyWhite	
Order Codes and Bins - 9 V.....	4
Flux Characteristics, ANSI White	
Order Codes and Bins - 9 V.....	6
Flux Characteristics, EasyWhite	
Order Codes and Bins - 37 V.....	8
Flux Characteristics, ANSI White	
Order Codes and Bins - 37 V.....	10
Relative Spectral Power	
Distribution.....	12
Electrical Characteristics.....	13
Relative Luminous Flux.....	14
Typical Spatial Distribution.....	16
Performance Groups - Brightness....	16
Performance Groups - Chromaticity.17	
Cree EasyWhite Bins Plotted on the	
1931 CIE Color Space	19
Cree ANSI White Bins Plotted on	
the 1931 CIE Color Space.....	20
Bin and Order Code Formats	21
Mechanical Dimensions.....	21
Thermal Design.....	22
Notes.....	24
Packaging.....	25



CHARACTERISTICS

Characteristics	Unit	Minimum	Typical	Maximum
Viewing angle (FWHM)	degrees		115	
ESD withstand voltage (HBM per Mil-Std-883D)	V			8000
DC forward current (9 V)	mA			1000*
DC forward current (37 V)	mA			250*
Reverse current (9 V, 37 V)	mA			0.1
Forward voltage (9 V, 400 mA, 85 °C)	V		9.3	
Forward voltage (9 V, 400 mA, 25 °C)	V			10.5
Forward voltage (37 V, 100 mA, 85 °C)	V		37	
Forward voltage (37 V, 100 mA, 25 °C)	V			42

* Refer to the Operating Limits section.

OPERATING LIMITS

The maximum current rating of the CXA1304 is dependent on the case temperature (T_c) when the LED has reached thermal equilibrium under steady-state operation. Please refer to the Mechanical Dimensions section on page 21 for the location of the T_c measurement point.



FLUX CHARACTERISTICS, EASYWHITE ORDER CODES AND BINS - 9 V ($I_F = 400 \text{ mA}$, $T_J = 85 \text{ }^\circ\text{C}$)

The following tables provide order codes for XLamp CXA1304 LEDs. For a complete description of the order code nomenclature, please reference Bin and Order Code Formats (page 21).

CCT Range	CRI		Base Order Codes Min. Luminous Flux @ 400 mA			2-Step Order Code		4-Step Order Code	
	Min	Typ	Group	Flux (lm) @ 85 °C	Flux (lm) @ 25 °C*	Chromaticity Region		Chromaticity Region	
6500 K	70	75	B4	410	457			65F	CXA1304-0000-000C00B465F
			C2	440	490				CXA1304-0000-000C00C265F
			C4	475	527				CXA1304-0000-000C00C465F
	80	---	B2	380	423			65F	CXA1304-0000-000C0HB265F
			B4	410	457				CXA1304-0000-000C0HB465F
			C2	440	490				CXA1304-0000-000C0HC265F
5700 K	70	75	B4	410	457			57F	CXA1304-0000-000C00B457F
			C2	440	490				CXA1304-0000-000C00C257F
			C4	475	527				CXA1304-0000-000C00C457F
	80	---	B2	380	423			57F	CXA1304-0000-000C0HB257F
			B4	410	457				CXA1304-0000-000C0HB457F
			C2	440	490				CXA1304-0000-000C0HC257F
5000 K	70	75	B4	410	457	50H		50F	CXA1304-0000-000C00B450H
			C2	440	490				CXA1304-0000-000C00C250H
			C4	475	527				CXA1304-0000-000C00C450H
	80	---	B2	380	423	50H		50F	CXA1304-0000-000C0HB250H
			B4	410	457				CXA1304-0000-000C0HB450H
			C2	440	490				CXA1304-0000-000C0HC250H
	90	95	A2	330	366	50H		50F	CXA1304-0000-000C0UA250H
			A4	355	396				CXA1304-0000-000C0UA450H
4000 K	70	75	B2	380	423	40H		40F	CXA1304-0000-000C00B240H
			B4	410	457				CXA1304-0000-000C00B440H
			C2	440	490				CXA1304-0000-000C00C240H
	80	---	A4	355	396	40H		40F	CXA1304-0000-000C0HA440H
			B2	380	423				CXA1304-0000-000C0HB240H
			B4	410	457				CXA1304-0000-000C0HB440H
	90	95	94	308	342	40H		40F	CXA1304-0000-000C0U9440H
			A2	330	366				CXA1304-0000-000C0UA240H

Notes

- Cree maintains a tolerance of $\pm 7\%$ on flux and power measurements, ± 0.005 on chromaticity (CCx, CCy) measurements and a tolerance of ± 2 on CRI measurements.
- * Flux values @ 25 °C are calculated and for reference only.

**FLUX CHARACTERISTICS, EASYWHITE ORDER CODES AND BINS - 9 V ($I_f = 400 \text{ mA}$, $T_j = 85 \text{ }^\circ\text{C}$)
 - CONTINUED**

CCT Range	CRI		Base Order Codes Min. Luminous Flux @ 400 mA			2-Step Order Code		4-Step Order Code	
	Min	Typ	Group	Flux (lm) @ 85 °C	Flux (lm) @ 25 °C*	Chromaticity Region		Chromaticity Region	
3500 K	80	---	A4	355	396	35H	CXA1304-0000-000C00A435H	35F	CXA1304-0000-000C00A435F
			B2	380	423		CXA1304-0000-000C00B235H		CXA1304-0000-000C00B235F
			B4	410	457		CXA1304-0000-000C00B435H		CXA1304-0000-000C00B435F
	93	95	92	286	317	35H	CXA1304-0000-000C0Y9235H	35F	CXA1304-0000-000C0Y9235F
			94	308	342		CXA1304-0000-000C0Y9435H		CXA1304-0000-000C0Y9435F
3000 K	80	---	A4	355	396	30H	CXA1304-0000-000C00A430H	30F	CXA1304-0000-000C00A430F
			B2	380	423		CXA1304-0000-000C00B230H		CXA1304-0000-000C00B230F
			84	268	297		30H		CXA1304-0000-000C0Y8430H
	92	286	317	CXA1304-0000-000C0Y9230H	CXA1304-0000-000C0Y9230F				
	2700 K	80	---	A2	330	368	27H	CXA1304-0000-000C00A227H	27F
A4				355	396	CXA1304-0000-000C00A427H		CXA1304-0000-000C00A427F	
B2				380	423	CXA1304-0000-000C00B227H		CXA1304-0000-000C00B227F	
93		95	82	249	276	27H	CXA1304-0000-000C0Y8227H	27F	CXA1304-0000-000C0Y8227F
			84	268	297		CXA1304-0000-000C0Y8427H		CXA1304-0000-000C0Y8427F

Notes

- Cree maintains a tolerance of $\pm 7\%$ on flux and power measurements, ± 0.005 on chromaticity (CCx, CCy) measurements and a tolerance of ± 2 on CRI measurements.
- * Flux values @ 25 °C are calculated and for reference only.

FLUX CHARACTERISTICS, ANSI WHITE ORDER CODES AND BINS - 9 V ($I_F = 400 \text{ mA}$, $T_j = 85 \text{ }^\circ\text{C}$)

The following tables provide order codes for XLamp CXA1304 LEDs. For a complete description of the order code nomenclature, please reference Bin and Order Code Formats (page 21).

CCT Range	CRI		Base Order Codes Min. Luminous Flux @ 400 mA			Chromaticity Regions	Order Code
	Min	Typ	Group	Flux (lm) @ 85 °C	Flux (lm) @ 25 °C*		
6500 K	70	75	B4	410	457	1A0, 1B0, 1C0, 1D0	CXA1304-0000-000C00B40E1
			C2	440	490		CXA1304-0000-000C00C20E1
			C4	475	527		CXA1304-0000-000C00C40E1
	80	---	B2	380	423	1A0, 1B0, 1C0, 1D0	CXA1304-0000-000C0HB20E1
			B4	410	457		CXA1304-0000-000C0HB40E1
			C2	440	490		CXA1304-0000-000C0HC20E1
5700 K	70	75	B4	410	457	2A0, 2B0, 2C0, 2D0	CXA1304-0000-000C00B40E2
			C2	440	490		CXA1304-0000-000C00C20E2
			C4	475	527		CXA1304-0000-000C00C40E2
	80	---	B2	380	423	2A0, 2B0, 2C0, 2D0	CXA1304-0000-000C0HB20E2
			B4	410	457		CXA1304-0000-000C0HB40E2
			C2	440	490		CXA1304-0000-000C0HC20E2
5000 K	70	75	B4	410	457	3A0, 3B0, 3C0, 3D0	CXA1304-0000-000C00B40E3
			C2	440	490		CXA1304-0000-000C00C20E3
			C4	475	527		CXA1304-0000-000C00C40E3
	80	---	B2	380	423	3A0, 3B0, 3C0, 3D0	CXA1304-0000-000C0HB20E3
			B4	410	457		CXA1304-0000-000C0HB40E3
			C2	440	490		CXA1304-0000-000C0HC20E3
	90	95	A2	330	366	3A0, 3B0, 3C0, 3D0	CXA1304-0000-000C0UA20E3
			A4	355	396		CXA1304-0000-000C0UA40E3
4000 K	70	75	B2	380	423	5A0, 5B0, 5C0, 5D0	CXA1304-0000-000C00B20E5
			B4	410	457		CXA1304-0000-000C00B40E5
			C2	440	490		CXA1304-0000-000C00C20E5
	80	---	A4	355	396	5A0, 5B0, 5C0, 5D0	CXA1304-0000-000C0HA40E5
			B2	380	423		CXA1304-0000-000C0HB20E5
			B4	410	457		CXA1304-0000-000C0HB40E5
	90	95	A4	355	396	5A0, 5B0, 5C0, 5D0	CXA1304-0000-000C0UA40E5
			A2	330	366		CXA1304-0000-000C0UA20E5

Notes

- Cree maintains a tolerance of $\pm 7\%$ on flux and power measurements, ± 0.005 on chromaticity (CCx, CCy) measurements and a tolerance of ± 2 on CRI measurements.
- * Flux values @ 25 °C are calculated and for reference only.

**FLUX CHARACTERISTICS, ANSI WHITE ORDER CODES AND BINS - 9 V ($I_F = 400 \text{ mA}$, $T_J = 85 \text{ }^\circ\text{C}$)
 - CONTINUED**

CCT Range	CRI		Base Order Codes Min. Luminous Flux @ 400 mA			Chromaticity Regions	Order Code
	Min	Typ	Group	Flux (lm) @ 85 °C	Flux (lm) @ 25 °C*		
3500 K	80	---	A4	355	396	6A0, 6B0, 6C0, 6D0	CXA1304-0000-000C00A40E6
			B2	380	423		CXA1304-0000-000C00B20E6
			B4	410	457		CXA1304-0000-000C00B40E6
	93	95	92	286	317	6A0, 6B0, 6C0, 6D0	CXA1304-0000-000C0Y920E6
			94	308	342		CXA1304-0000-000C0Y940E6
3000 K	80	---	A4	355	396	7A0, 7B0, 7C0, 7D0	CXA1304-0000-000C00A40E7
			B2	380	423		CXA1304-0000-000C00B20E7
	93	95	84	268	297	7A0, 7B0, 7C0, 7D0	CXA1304-0000-000C0Y840E7
			92	286	317		CXA1304-0000-000C0Y920E7
2700 K	80	---	A2	330	368	8A0, 8B0, 8C0, 8D0	CXA1304-0000-000C00A20E8
			A4	355	396		CXA1304-0000-000C00A40E8
			B2	380	423		CXA1304-0000-000C00B20E8
	93	95	82	249	276	8A0, 8B0, 8C0, 8D0	CXA1304-0000-000C0Y820E8
			84	268	297		CXA1304-0000-000C0Y840E8

Notes

- Cree maintains a tolerance of $\pm 7\%$ on flux and power measurements, ± 0.005 on chromaticity (CCx, CCy) measurements and a tolerance of ± 2 on CRI measurements.
- * Flux values @ 25 °C are calculated and for reference only.

FLUX CHARACTERISTICS, EASYWHITE ORDER CODES AND BINS - 37 V ($I_f = 100 \text{ mA}$, $T_j = 85 \text{ }^\circ\text{C}$)

The following tables provide order codes for XLamp CXA1304 LEDs. For a complete description of the order code nomenclature, please reference Bin and Order Code Formats (page 21).

CCT Range	CRI		Base Order Codes Min. Luminous Flux @ 100 mA			2-Step Order Code		4-Step Order Code	
	Min	Typ	Group	Flux (lm) @ 85 °C	Flux (lm) @ 25 °C*	Chromaticity Region		Chromaticity Region	
6500 K	70	75	B4	410	457	50H		65F	CXA1304-0000-000N00B465F
			C2	440	490				CXA1304-0000-000N00C265F
			C4	475	527				CXA1304-0000-000N00C465F
	80	---	B2	380	423	50H		65F	CXA1304-0000-000N0HB265F
			B4	410	457				CXA1304-0000-000N0HB465F
			C2	440	490				CXA1304-0000-000N0HC265F
5700 K	70	75	B4	410	457	50H		57F	CXA1304-0000-000N00B457F
			C2	440	490				CXA1304-0000-000N00C257F
			C4	475	527				CXA1304-0000-000N00C457F
	80	---	B2	380	423	50H		57F	CXA1304-0000-000N0HB257F
			B4	410	457				CXA1304-0000-000N0HB457F
			C2	440	490				CXA1304-0000-000N0HC257F
5000 K	70	75	B4	410	457	50H	CXA1304-0000-000N00B450H	50F	CXA1304-0000-000N00B450F
			C2	440	490		CXA1304-0000-000N00C250H		CXA1304-0000-000N00C250F
			C4	475	527		CXA1304-0000-000N00C450H		CXA1304-0000-000N00C450F
	80	---	B2	380	423	50H	CXA1304-0000-000N0HB250H	50F	CXA1304-0000-000N0HB250F
			B4	410	457		CXA1304-0000-000N0HB450H		CXA1304-0000-000N0HB450F
			C2	440	490		CXA1304-0000-000N0HC250H		CXA1304-0000-000N0HC250F
	90	95	A2	330	366	50H	CXA1304-0000-000N0UA250H	50F	CXA1304-0000-000N0UA250F
			A4	355	396		CXA1304-0000-000N0UA450H		CXA1304-0000-000N0UA450F

Notes

- Cree maintains a tolerance of $\pm 7\%$ on flux and power measurements, ± 0.005 on chromaticity (CCx, CCy) measurements and a tolerance of ± 2 on CRI measurements.
- * Flux values @ 25 °C are calculated and for reference only.

**FLUX CHARACTERISTICS, EASYWHITE ORDER CODES AND BINS - 37 V ($I_f = 100 \text{ mA}$, $T_j = 85 \text{ }^\circ\text{C}$)
 - CONTINUED**

CCT Range	CRI		Base Order Codes Min. Luminous Flux @ 100 mA			2-Step Order Code		4-Step Order Code	
	Min	Typ	Group	Flux (lm) @ 85 °C	Flux (lm) @ 25 °C*	Chromaticity Region		Chromaticity Region	
4000 K	70	75	B2	380	423	40H	CXA1304-0000-000N00B240H	40F	CXA1304-0000-000N00B240F
			B4	410	457		CXA1304-0000-000N00B440H		CXA1304-0000-000N00B440F
			C2	440	490		CXA1304-0000-000N00C240H		CXA1304-0000-000N00C240F
	80	---	A4	355	396	40H	CXA1304-0000-000N0HA440H	40F	CXA1304-0000-000N0HA440F
			B2	380	423		CXA1304-0000-000N0HB240H		CXA1304-0000-000N0HB240F
			B4	410	457		CXA1304-0000-000N0HB440H		CXA1304-0000-000N0HB440F
	90	95	94	308	342	40H	CXA1304-0000-000N0U9440H	40F	CXA1304-0000-000N0U9440F
			A2	330	366		CXA1304-0000-000N0UA240H		CXA1304-0000-000N0UA240F
	3500 K	80	---	A4	355	396	35H	CXA1304-0000-000N00A435H	35F
B2				380	423	CXA1304-0000-000N00B235H		CXA1304-0000-000N00B235F	
B4				410	457	CXA1304-0000-000N00B435H		CXA1304-0000-000N00B435F	
93		95	92	286	317	35H	CXA1304-0000-000N0Y9235H	35F	CXA1304-0000-000N0Y9235F
			94	308	342		CXA1304-0000-000N0Y9435H		CXA1304-0000-000N0Y9435F
3000 K	80	---	A4	355	396	30H	CXA1304-0000-000N00A430H	30F	CXA1304-0000-000N00A430F
			B2	380	423		CXA1304-0000-000N00B230H		CXA1304-0000-000N00B230F
	93	95	84	268	297	30H	CXA1304-0000-000N0Y8430H	30F	CXA1304-0000-000N0Y8430F
			92	286	317		CXA1304-0000-000N0Y9230H		CXA1304-0000-000N0Y9230F
2700 K	80	---	A2	330	368	27H	CXA1304-0000-000N00A227H	27F	CXA1304-0000-000N00A227F
			A4	355	396		CXA1304-0000-000N00A427H		CXA1304-0000-000N00A427F
			B2	380	423		CXA1304-0000-000N00B227H		CXA1304-0000-000N00B227F
	93	95	82	249	276	27H	CXA1304-0000-000N0Y8227H	27F	CXA1304-0000-000N0Y8227F
			84	268	297		CXA1304-0000-000N0Y8427H		CXA1304-0000-000N0Y8427F

Notes

- Cree maintains a tolerance of $\pm 7\%$ on flux and power measurements, ± 0.005 on chromaticity (CCx, CCy) measurements and a tolerance of ± 2 on CRI measurements.
- * Flux values @ 25 °C are calculated and for reference only.

FLUX CHARACTERISTICS, ANSI WHITE ORDER CODES AND BINS - 37 V ($I_f = 100$ mA, $T_j = 85$ °C)

The following tables provide order codes for XLamp CXA1304 LEDs. For a complete description of the order code nomenclature, please reference Bin and Order Code Formats (page 21).

CCT Range	CRI		Base Order Codes Min. Luminous Flux @ 100 mA			Chromaticity Regions	Order Code
	Min	Typ	Group	Flux (lm) @ 85 °C	Flux (lm) @ 25 °C*		
6500 K	70	75	B4	410	457	1A0, 1B0, 1C0, 1D0	CXA1304-0000-000N00B40E1
			C2	440	490		CXA1304-0000-000N00C20E1
			C4	475	527		CXA1304-0000-000N00C40E1
	80	---	B2	380	423	1A0, 1B0, 1C0, 1D0	CXA1304-0000-000N0HB20E1
			B4	410	457		CXA1304-0000-000N0HB40E1
			C2	440	490		CXA1304-0000-000N0HC20E1
5700 K	70	75	B4	410	457	2A0, 2B0, 2C0, 2D0	CXA1304-0000-000N00B40E2
			C2	440	490		CXA1304-0000-000N00C20E2
			C4	475	527		CXA1304-0000-000N00C40E2
	80	---	B2	380	423	2A0, 2B0, 2C0, 2D0	CXA1304-0000-000N0HB20E2
			B4	410	457		CXA1304-0000-000N0HB40E2
			C2	440	490		CXA1304-0000-000N0HC20E2
5000 K	70	75	B4	410	457	3A0, 3B0, 3C0, 3D0	CXA1304-0000-000N00B40E3
			C2	440	490		CXA1304-0000-000N00C20E3
			C4	475	527		CXA1304-0000-000N00C40E3
	80	---	B2	380	423	3A0, 3B0, 3C0, 3D0	CXA1304-0000-000N0HB20E3
			B4	410	457		CXA1304-0000-000N0HB40E3
			C2	440	490		CXA1304-0000-000N0HC20E3
	90	95	A2	330	366	3A0, 3B0, 3C0, 3D0	CXA1304-0000-000N0UA20E3
			A4	355	396		CXA1304-0000-000N0UA40E3

Notes

- Cree maintains a tolerance of $\pm 7\%$ on flux and power measurements, ± 0.005 on chromaticity (CCx, CCy) measurements and a tolerance of ± 2 on CRI measurements.
- * Flux values @ 25 °C are calculated and for reference only.

FLUX CHARACTERISTICS, ANSI WHITE ORDER CODES AND BINS - 37 V ($I_f = 100$ mA, $T_j = 85$ °C) - CONTINUED

CCT Range	CRI		Base Order Codes Min. Luminous Flux @ 100 mA			Chromaticity Regions	Order Code
	Min	Typ	Group	Flux (lm) @ 85 °C	Flux (lm) @ 25 °C*		
4000 K	70	75	B2	380	423	5A0, 5B0, 5C0, 5D0	CXA1304-0000-000N00B20E5
			B4	410	457		CXA1304-0000-000N00B40E5
			C2	440	490		CXA1304-0000-000N00C20E5
	80	---	A4	355	396	5A0, 5B0, 5C0, 5D0	CXA1304-0000-000N00HA40E5
			B2	380	423		CXA1304-0000-000N00HB20E5
			B4	410	457		CXA1304-0000-000N00HB40E5
	90	95	94	308	342	5A0, 5B0, 5C0, 5D0	CXA1304-0000-000N00U940E5
			A2	330	366		CXA1304-0000-000N00UA20E5
	3500 K	80	---	A4	355	396	6A0, 6B0, 6C0, 6D0
B2				380	423	CXA1304-0000-000N00B20E6	
B4				410	457	CXA1304-0000-000N00B50E6	
93		95	92	286	317	6A0, 6B0, 6C0, 6D0	CXA1304-0000-000N0Y920E6
			94	308	342		CXA1304-0000-000N0Y940E6
3000 K	80	---	A4	355	396	7A0, 7B0, 7C0, 7D0	CXA1304-0000-000N00A40E7
			B2	380	423		CXA1304-0000-000N00B20E7
	93	95	84	268	297	7A0, 7B0, 7C0, 7D0	CXA1304-0000-000N0Y840E7
			92	286	317		CXA1304-0000-000N0Y920E7
2700 K	80	---	A2	330	368	8A0, 8B0, 8C0, 8D0	CXA1304-0000-000N00A20E8
			A4	355	396		CXA1304-0000-000N00A40E8
			B2	380	423		CXA1304-0000-000N00B20E8
	93	95	82	249	276	8A0, 8B0, 8C0, 8D0	CXA1304-0000-000N0Y820E8
			84	268	297		CXA1304-0000-000N0Y840E8

RELATIVE SPECTRAL POWER DISTRIBUTION (9 V, $I_F = 400$ mA; 37 V, $I_F = 100$ mA, $T_j = 85$ °C)

The following graph is the result of a series of pulsed measurements at 400 mA for the 9-V CXA1304 LED and 100 mA for the 37-V CXA1304 LED and $T_j = 85$ °C.



ELECTRICAL CHARACTERISTICS

The following graphs are the result of a series of steady-state measurements.



RELATIVE LUMINOUS FLUX

The relative luminous flux values provided below are the ratio of:

- Measurements of CXA1304 at steady-state operation at the given conditions, divided by
- Flux measured during binning, which is a pulsed measurement at 400 mA at $T_j = 85\text{ }^\circ\text{C}$ for the 9-V CXA1304 LED.

Using the 9-V CXA1304 LED as an example, at steady-state operation of $T_c = 55\text{ }^\circ\text{C}$, $I_f = 700\text{ mA}$, the relative luminous flux ratio is 160% in the chart below. A 9-V CXA1304 LED that measures 380 lm during binning will deliver 608 lm ($380 * 1.6$) at steady-state operation of $T_c = 55\text{ }^\circ\text{C}$, $I_f = 700\text{ mA}$.



RELATIVE LUMINOUS FLUX - CONTINUED

The relative luminous flux values provided below are the ratio of:

- Measurements of CXA1304 at steady-state operation at the given conditions, divided by
- Flux measured during binning, which is a pulsed measurement at 100 mA at $T_j = 85\text{ }^\circ\text{C}$ for the 37-V CXA1304 LED.

Using the 37-V CXA1304 LED as an example, at steady-state operation of $T_c = 55\text{ }^\circ\text{C}$, $I_f = 175\text{ mA}$, the relative luminous flux ratio is 160% in the chart below. A 37-V CXA1304 LED that measures 380 lm during binning will deliver 608 lm ($380 * 1.6$) at steady-state operation of $T_c = 55\text{ }^\circ\text{C}$, $I_f = 175\text{ mA}$.



TYPICAL SPATIAL DISTRIBUTION

PERFORMANCE GROUPS - BRIGHTNESS (9 V, I_F = 400 mA; 37 V, I_F = 100 mA, T_J = 85 °C)

XLamp CXA1304 LEDs are tested for luminous flux and placed into one of the following bins.

Group Code	Min. Luminous Flux	Max. Luminous Flux
82	249	268
84	268	286
92	286	308
94	308	330
A2	330	355
A4	355	380
B2	380	410
B4	410	440
C2	440	475
C4	475	510

PERFORMANCE GROUPS - CHROMATICITY ($T_j = 85\text{ }^\circ\text{C}$)

XLamp CXA1304 LEDs are tested for chromaticity and placed into one of the regions defined by the following bounding coordinates.

EasyWhite Color Temperatures – 4-Step			
Code	CCT	x	y
65F	6500 K	0.3253	0.3325
		0.3249	0.3439
		0.3331	0.3514
		0.3330	0.3393
57F	5700 K	0.3097	0.3196
		0.3079	0.3297
		0.3164	0.3382
		0.3176	0.3275
50F	5000 K	0.3407	0.3459
		0.3415	0.3586
		0.3499	0.3654
		0.3484	0.3521
40F	4000 K	0.3744	0.3685
		0.3782	0.3837
		0.3912	0.3917
		0.3863	0.3758
35F	3500 K	0.3981	0.3800
		0.4040	0.3966
		0.4186	0.4037
		0.4116	0.3865
30F	3000 K	0.4242	0.3919
		0.4322	0.4096
		0.4449	0.4141
		0.4359	0.3960
27F	2700 K	0.4475	0.3994
		0.4573	0.4178
		0.4695	0.4207
		0.4589	0.4021

EasyWhite Color Temperatures – 2-Step			
Code	CCT	x	y
50H	5000 K	0.3429	0.3507
		0.3434	0.3571
		0.3475	0.3604
		0.3469	0.3539
40H	4000 K	0.3784	0.3741
		0.3804	0.3818
		0.3867	0.3857
		0.3844	0.3778
35H	3500 K	0.4030	0.3857
		0.4061	0.3941
		0.4132	0.3976
		0.4099	0.3890
30H	3000 K	0.4291	0.3973
		0.4333	0.4062
		0.4395	0.4084
		0.4351	0.3994
27H	2700 K	0.4528	0.4046
		0.4578	0.4138
		0.4638	0.4152
		0.4586	0.4060

PERFORMANCE GROUPS - CHROMATICITY ($T_j = 85\text{ }^\circ\text{C}$) - CONTINUED

ANSI White Bins				
Code	CCT	Bin Code	x	y
0E1	6500 K	1A0	0.3048	0.3207
			0.3130	0.3290
			0.3144	0.3186
			0.3068	0.3113
		1B0	0.3028	0.3304
			0.3115	0.3391
			0.3130	0.3290
			0.3048	0.3207
		1C0	0.3115	0.3391
			0.3205	0.3481
			0.3213	0.3373
			0.3130	0.3290
		1D0	0.3130	0.3290
			0.3213	0.3373
			0.3221	0.3261
			0.3144	0.3186

ANSI White Bins				
Code	CCT	Bin Code	x	y
0E2	5700 K	2A0	0.3215	0.3350
			0.3290	0.3417
			0.3290	0.3300
			0.3222	0.3243
		2B0	0.3207	0.3462
			0.3290	0.3538
			0.3290	0.3417
			0.3215	0.3350
		2C0	0.3290	0.3538
			0.3376	0.3616
			0.3371	0.3490
			0.3290	0.3417
		2D0	0.3290	0.3417
			0.3371	0.3490
			0.3366	0.3369
			0.3290	0.3300

ANSI White Bins				
Code	CCT	Bin Code	x	y
0E3	5000 K	3A0	.3371	.3490
			.3451	.3554
			.3440	.3427
			.3366	.3369
		3B0	.3376	.3616
			.3463	.3687
			.3451	.3554
			.3371	.3490
		3C0	.3463	.3687
			.3551	.3760
			.3533	.3620
			.3451	.3554
		3D0	.3451	.3554
			.3533	.3620
			.3515	.3487
			.3440	.3427

ANSI White Bins				
Code	CCT	Bin Code	x	y
0E5	4000 K	5A0	.3670	.3578
			.3702	.3722
			.3825	.3798
			.3783	.3646
		5B0	.3702	.3722
			.3736	.3874
			.3869	.3958
			.3825	.3798
		5C0	.3825	.3798
			.3869	.3958
			.4006	.4044
			.3950	.3875
		5D0	.3783	.3646
			.3825	.3798
			.3950	.3875
			.3898	.3716

ANSI White Bins				
Code	CCT	Bin Code	x	y
0E6	3500 K	6A0	.3889	.3690
			.3941	.3848
			.4080	.3916
			.4017	.3751
		6B0	.3941	.3848
			.3996	.4015
			.4146	.4089
			.4080	.3916
		6C0	.4080	.3916
			.4146	.4089
			.4299	.4165
			.4221	.3984
		6D0	.4017	.3751
			.4080	.3916
			.4221	.3984
			.4147	.3814

PERFORMANCE GROUPS - CHROMATICITY ($T_j = 85\text{ }^\circ\text{C}$) - CONTINUED

ANSI White Bins				
Code	CCT	Bin Code	x	y
0E7	3000 K	7A0	.4147	.3814
			.4221	.3984
			.4342	.4028
			.4259	.3853
		7B0	.4221	.3984
			.4299	.4165
			.4430	.4212
			.4342	.4028
		7C0	.4342	.4028
			.4430	.4212
			.4562	.4260
			.4465	.4071
		7D0	.4259	.3853
			.4342	.4028
			.4465	.4071
			.4373	.3893

ANSI White Bins				
Code	CCT	Bin Code	x	y
0E8	2700 K	8A0	.4373	.3893
			.4465	.4071
			.4582	.4099
			.4483	.3919
		8B0	.4465	.4071
			.4562	.4260
			.4687	.4289
			.4582	.4099
		8C0	.4582	.4099
			.4687	.4289
			.4813	.4319
			.4700	.4126
		8D0	.4483	.3919
			.4582	.4099
			.4700	.4126
			.4593	.3944

CREE EASYWHITE BINS PLOTTED ON THE 1931 CIE COLOR SPACE ($T_j = 85\text{ }^\circ\text{C}$)



CREE ANSI WHITE BINS PLOTTED ON THE 1931 CIE COLOR SPACE ($T_j = 85^\circ\text{C}$)



BIN AND ORDER CODE FORMATS

Bin codes and order codes are configured as follows:

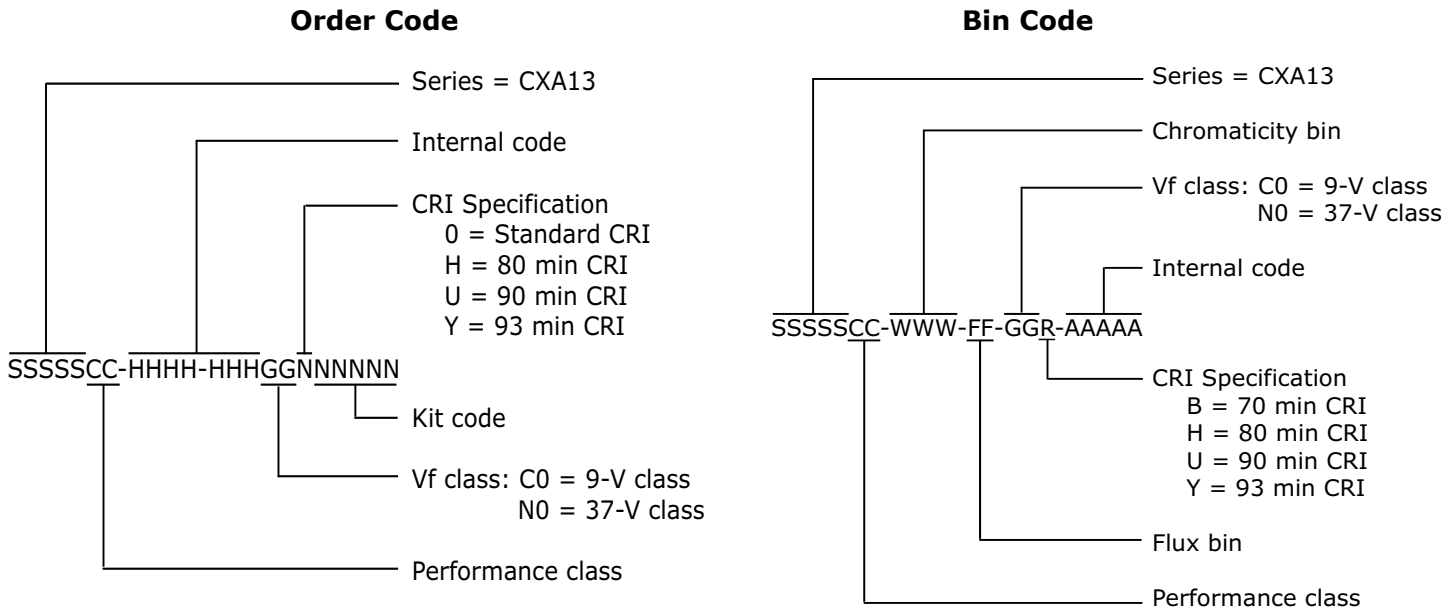

MECHANICAL DIMENSIONS

Dimensions are in mm.

Tolerances unless otherwise specified:

- .x ± .10
- .xx ± .03
- .xxx ± .010
- x° ± 1°

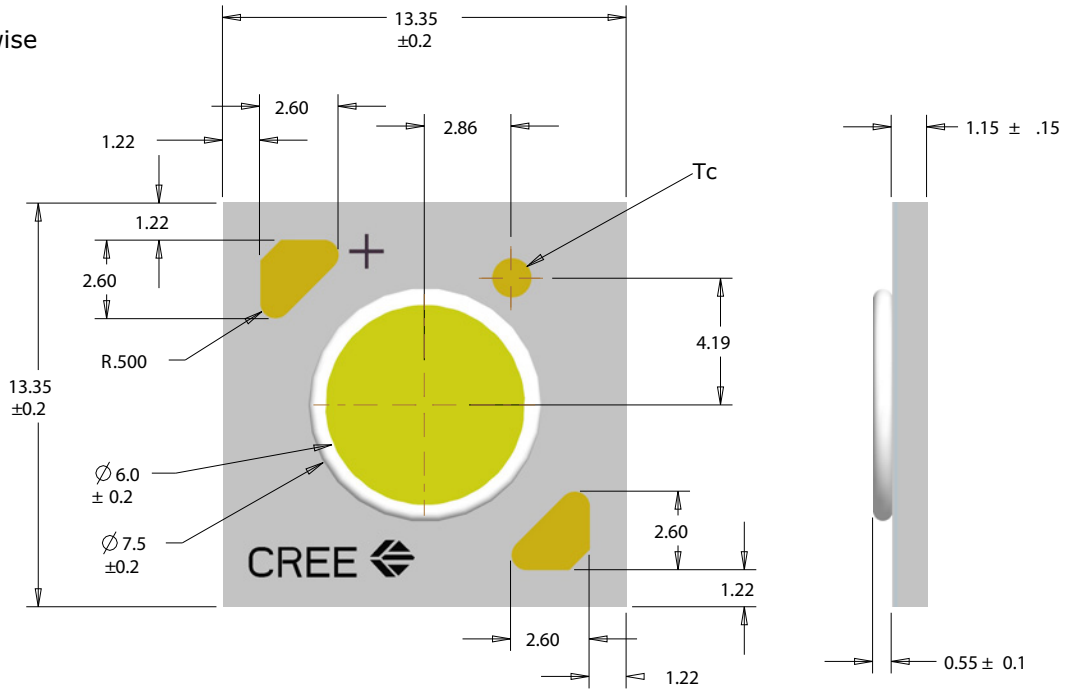

THERMAL DESIGN

The CXA family of LED arrays can include over a hundred different LED die inside one package, and thus over a hundred different junction temperatures (T_j). Cree has intentionally removed junction-temperature-based operating limits and replaced the commonplace maximum T_j calculations with maximum ratings based on forward current (I_f) and case temperature (T_c). No additional calculations are required to ensure the CXA LED is being operated within its designed limits. Please refer to page 2 for the Operating Limit specification.

Cree has measured the temperature at the bottom of the package, commonly referred to as the solder point (T_{sp}), and found this value to be equivalent to the temperature at the T_c location at the top of the package once the LED has reached thermal equilibrium. There is no need to calculate for T_j inside the package, as the thermal management design process, specifically from T_{sp} to ambient (T_a), remains identical to any other LED component. For more information on thermal management of Cree XLamp LEDs, please refer to the XLamp Thermal Management application note at www.cree.com/xlamp_app_notes/thermal_management. For CXA soldering recommendations and more information on thermal interface materials (TIM) and connection methods, please refer to the Cree XLamp CXA Family LEDs soldering and handling document at www.cree.com/xlamp_app_notes/CXA_SH.

To keep the CXA1304 LED at or below the maximum rated T_c , the case to ambient temperature thermal resistance (R_{c-a}) must be at or below the maximum R_{c-a} value shown on the following graphs, depending on the operating environment. The y-axis in each graph is a base 10 logarithmic scale.

As the figure at right shows, the R_{c-a} value is the sum of the thermal resistance of the TIM (R_{tim}) plus the thermal resistance of the heat sink (R_{hs}).



THERMAL DESIGN - CONTINUED



NOTES

Lumen Maintenance Projections

Cree now uses standardized IES LM-80-08 and TM-21-11 methods for collecting long-term data and extrapolating LED lumen maintenance. For information on the specific LM-80 data sets available for this LED, refer to the public LM-80 results document at www.cree.com/xlamp_app_notes/LM80_results.

Please read the XLamp Long-Term Lumen Maintenance application note at www.cree.com/xlamp_app_notes/lumen_maintenance for more details on Cree's lumen maintenance testing and forecasting. Please read the XLamp Thermal Management application note at www.cree.com/xlamp_app_notes/thermal_management for details on how thermal design, ambient temperature, and drive current affect the LED junction temperature.

RoHS Compliance

The levels of RoHS restricted materials in this product are below the maximum concentration values (also referred to as the threshold limits) permitted for such substances, or are used in an exempted application, in accordance with EU Directive 2011/65/EC (RoHS2), as implemented January 2, 2013. RoHS Declarations for this product can be obtained from your Cree representative or from the Product Documentation sections of www.cree.com.

REACH Compliance

REACH substances of high concern (SVHCs) information is available for this product. Since the European Chemical Agency (ECHA) has published notice of their intent to frequently revise the SVHC listing for the foreseeable future, please contact a Cree representative to insure you get the most up-to-date REACH SVHC Declaration. REACH banned substance information (REACH Article 67) is also available upon request.

UL Recognized Component

Level 4 enclosure consideration. The LED package or a portion thereof has been investigated as a fire and electrical enclosure per ANSI/UL 8750.

Vision Advisory Claim

Users should be cautioned not to stare at the light of this LED product. The bright light can damage the eye.

PACKAGING

Cree CXA1304 LEDs are packaged in trays of 20. Five trays are sealed in an anti-static bag and placed inside a carton, for a total of 100 LEDs per carton. Each carton contains 100 LEDs from the same performance bin.

Dimensions are in inches.

Tolerances:

.x ± .1

.xx ± .05

.xxx ± .005

x° ± 1°



PATENT LABEL IS LOCATED ON UNDERSIDE OF CARTON



LABEL WITH CREE BIN CODE, QTY, LOT#

BAG



LABEL WITH CREE BIN CODE, QTY, LOT#



Компания «ЭлектроПласт» предлагает заключение долгосрочных отношений при поставках импортных электронных компонентов на взаимовыгодных условиях!

Наши преимущества:

- Оперативные поставки широкого спектра электронных компонентов отечественного и импортного производства напрямую от производителей и с крупнейших мировых складов;
- Поставка более 17-ти миллионов наименований электронных компонентов;
- Поставка сложных, дефицитных, либо снятых с производства позиций;
- Оперативные сроки поставки под заказ (от 5 рабочих дней);
- Экспресс доставка в любую точку России;
- Техническая поддержка проекта, помощь в подборе аналогов, поставка прототипов;
- Система менеджмента качества сертифицирована по Международному стандарту ISO 9001;
- Лицензия ФСБ на осуществление работ с использованием сведений, составляющих государственную тайну;
- Поставка специализированных компонентов (Xilinx, Altera, Analog Devices, Intersil, Interpoint, Microsemi, Aeroflex, Peregrine, Syfer, Eurofarad, Texas Instrument, Miteq, Cobham, E2V, MA-COM, Hittite, Mini-Circuits, General Dynamics и др.);

Помимо этого, одним из направлений компании «ЭлектроПласт» является направление «Источники питания». Мы предлагаем Вам помощь Конструкторского отдела:

- Подбор оптимального решения, техническое обоснование при выборе компонента;
- Подбор аналогов;
- Консультации по применению компонента;
- Поставка образцов и прототипов;
- Техническая поддержка проекта;
- Защита от снятия компонента с производства.



Как с нами связаться

Телефон: 8 (812) 309 58 32 (многоканальный)

Факс: 8 (812) 320-02-42

Электронная почта: org@eplast1.ru

Адрес: 198099, г. Санкт-Петербург, ул. Калинина, дом 2, корпус 4, литера А.