



60×60×25 mm

San Ace 60W 9WL type   

General Specifications

- Material Frame: Aluminum (Black coating), Impeller: Plastic (Flammability: UL 94V-1)
- Expected life See the table below. (L10 life: 90% survival rate for continuous operation in indoor free air at 60°C, rated voltage)
- Motor protection function Locked rotor burnout protection, Reverse polarity protection
For details, please refer to p. 547.
- Dielectric strength 50/60 Hz, 500 VAC, for 1 minute (between lead wire conductors and frame)
- Insulation resistance 10 MΩ or more with a 500 VDC megger (between lead wire conductors and frame)
- Sound pressure level (SPL) At 1 m away from the air inlet
- Storage temperature -30 to +70°C (Non-condensing)
- Lead wire ⊕Red ⊖Black (Sensor) Yellow (Control) Brown
- Mass 120 g
- Ingress protection IP68

Specifications

The models listed below **have pulse sensors with PWM control function.**

| Model no. | Rated voltage [V] | Operating voltage range [V] | PWM duty cycle* [%] | Rated current [A] | Rated input [W] | Rated speed [min ⁻¹] | Max. airflow [m ³ /min] [CFM] | Max. static pressure [Pa] [inchH ₂ O] | SPL [dB (A)] | Operating temperature [°C] | Expected life [h] |
|---------------|-------------------|-----------------------------|---------------------|-------------------|-----------------|----------------------------------|--|--|--------------|----------------------------|-------------------|
| 9WL0612P4S001 | 12 | 10.8 to 13.2 | 100 | 0.67 | 8.04 | 11000 | 1.4 49.4 | 300 1.204 | 53 | -20 to +70 | 180000/60°C |
| | | | 20 | 0.06 | 0.72 | 2900 | 0.36 12.7 | 20.8 0.083 | 20 | | |
| 9WL0612P4J001 | | | 100 | 0.39 | 4.68 | 8650 | 1.1 38.8 | 182 0.73 | 47 | | |
| | | | 20 | 0.03 | 0.36 | 1150 | 0.13 4.8 | 3.3 0.013 | 14 | | |
| 9WL0612P4H001 | | | 100 | 0.17 | 2.04 | 6150 | 0.78 27.5 | 97 0.389 | 36 | | |
| | | | 20 | 0.03 | 0.36 | 1350 | 0.17 6.0 | 4.7 0.018 | 14 | | |
| 9WL0624P4S001 | 24 | 21.6 to 26.4 | 100 | 0.34 | 8.16 | 11000 | 1.4 49.4 | 300 1.204 | 53 | | |
| | | | 20 | 0.03 | 0.72 | 2900 | 0.36 12.7 | 20.8 0.083 | 20 | | |
| 9WL0624P4J001 | | | 100 | 0.19 | 4.56 | 8650 | 1.1 38.8 | 182 0.73 | 47 | | |
| | | | 20 | 0.02 | 0.48 | 2200 | 0.28 9.8 | 12.0 0.048 | 17 | | |
| 9WL0624P4H001 | | | 100 | 0.08 | 1.92 | 6150 | 0.78 27.5 | 97 0.389 | 36 | | |
| | | | 20 | 0.02 | 0.48 | 1300 | 0.16 5.6 | 4.3 0.017 | 14 | | |

* PWM frequency: 25 kHz. Fan does not rotate when PWM duty cycle is 0%.

The following sensor and control options are available for selection.

Differs according to the model. Refer to the table on p. 579. Without sensor Pulse sensor Lock sensor

Airflow - Static Pressure Characteristics / PWM Duty - Speed Characteristics Example

9WL0612P4S001 With pulse sensor with PWM control function

PWM duty cycle

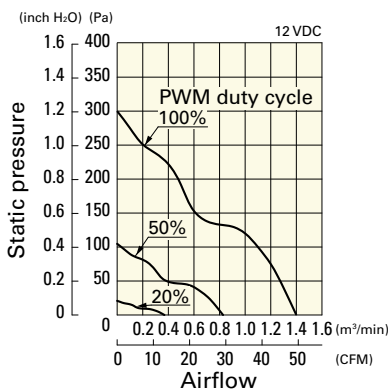

Operating voltage range

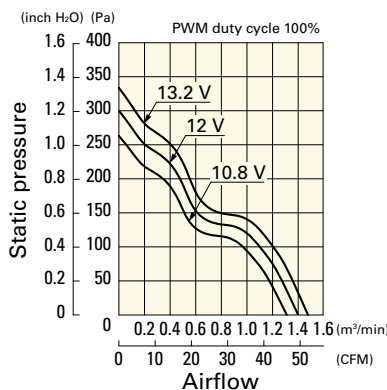

PWM duty - Speed characteristics example

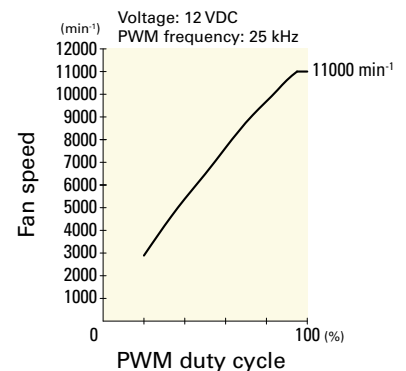

Airflow - Static Pressure Characteristics / PWM Duty - Speed Characteristics Example

9WL0612P4J001 With pulse sensor with PWM control function

PWM duty cycle

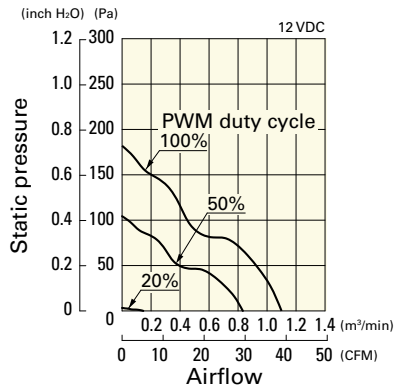

Operating voltage range

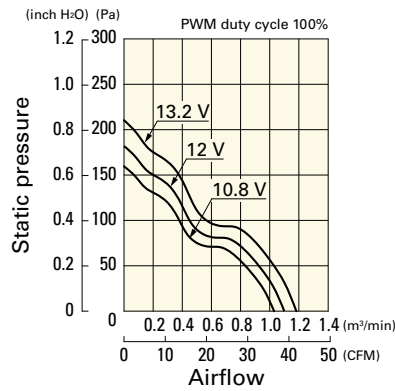

PWM duty - Speed characteristics example

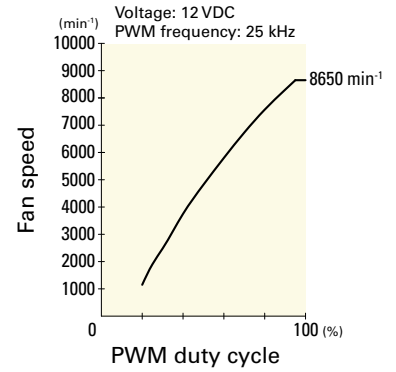

9WL0612P4H001 With pulse sensor with PWM control function

PWM duty cycle

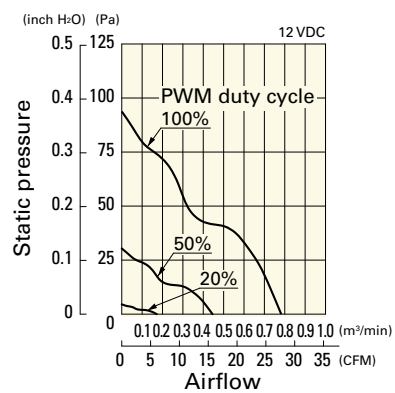

Operating voltage range

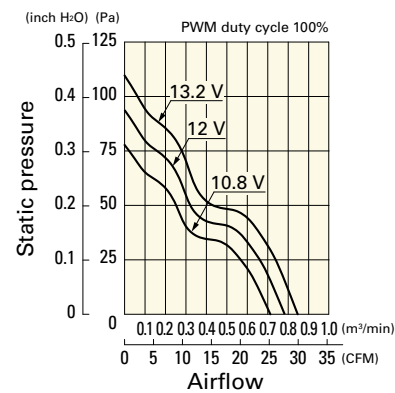

PWM duty - Speed characteristics example

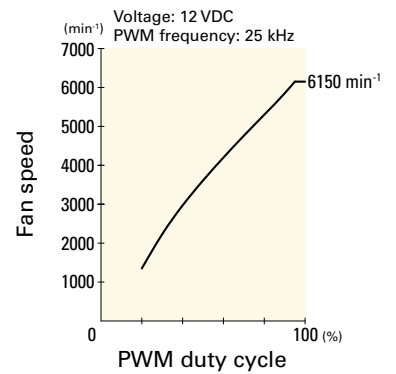

9WL0624P4S001 With pulse sensor with PWM control function

PWM duty cycle

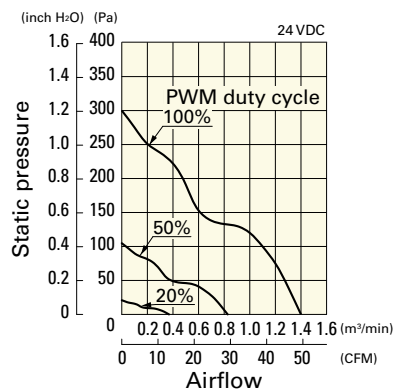

Operating voltage range

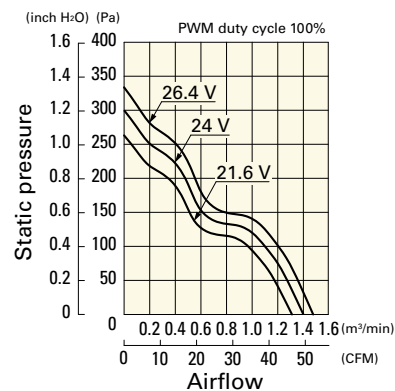

PWM duty - Speed characteristics example

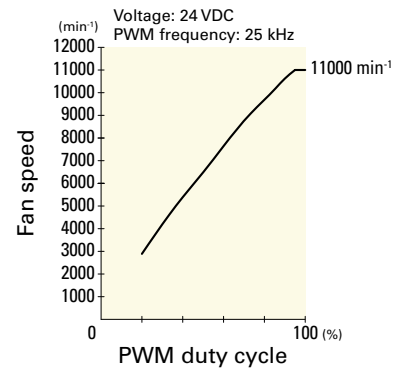

9WL0624P4J001 With pulse sensor with PWM control function

PWM duty cycle

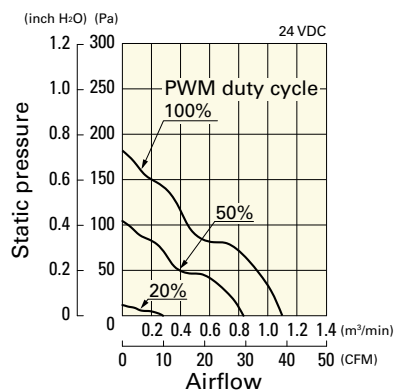

Operating voltage range

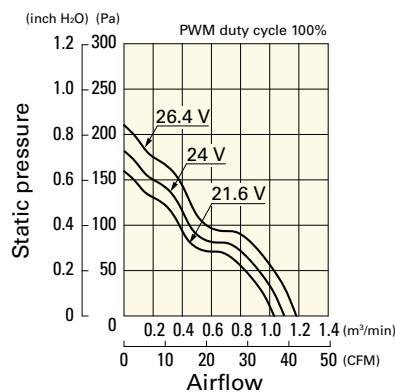

PWM duty - Speed characteristics example

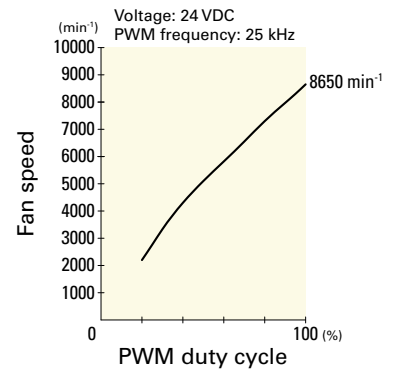

Airflow - Static Pressure Characteristics / PWM Duty - Speed Characteristics Example

9WL0624P4H001 With pulse sensor with PWM control function

PWM duty cycle

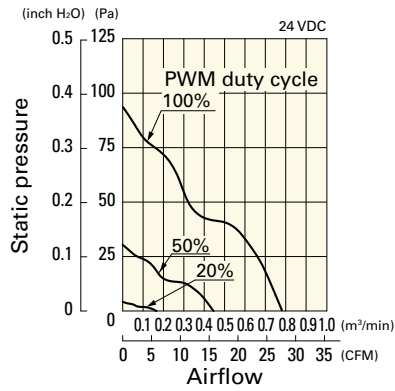

Operating voltage range

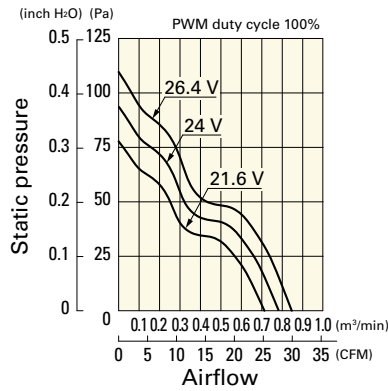

PWM duty - Speed characteristics example

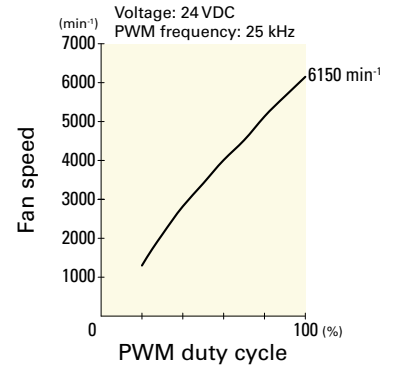

Dimensions (unit: mm)

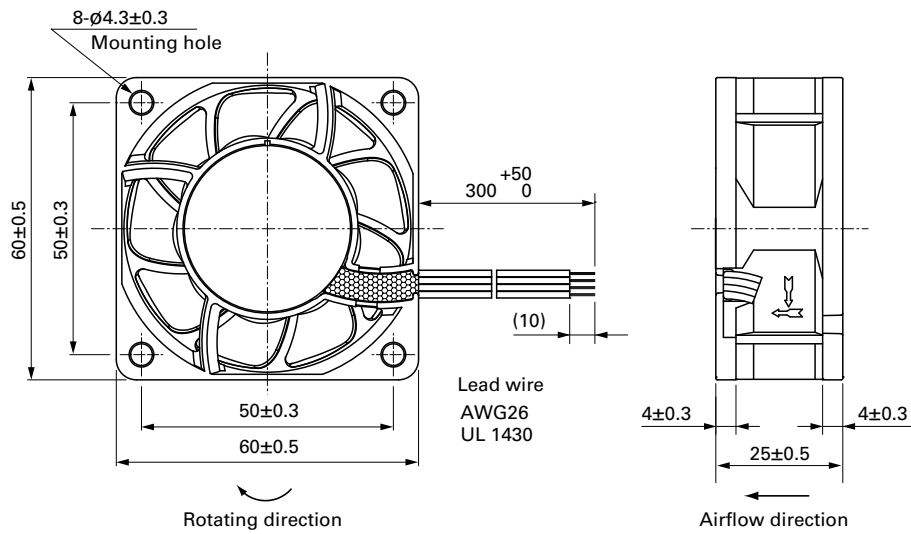

Reference Dimensions of Mounting Holes and Vent Opening (unit: mm)

Inlet side, Outlet side

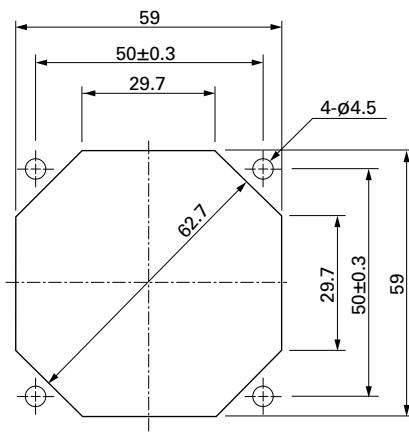

Options

Finger guards

page: p. 532

Model no.: 109-139E, 109-139H

Resin finger guards

page: p. 539

Model no.: 109-1003G

DC
Splash Proof Fan 60 mm sq.



Компания «ЭлектроПласт» предлагает заключение долгосрочных отношений при поставках импортных электронных компонентов на взаимовыгодных условиях!

Наши преимущества:

- Оперативные поставки широкого спектра электронных компонентов отечественного и импортного производства напрямую от производителей и с крупнейших мировых складов;
- Поставка более 17-ти миллионов наименований электронных компонентов;
- Поставка сложных, дефицитных, либо снятых с производства позиций;
- Оперативные сроки поставки под заказ (от 5 рабочих дней);
- Экспресс доставка в любую точку России;
- Техническая поддержка проекта, помощь в подборе аналогов, поставка прототипов;
- Система менеджмента качества сертифицирована по Международному стандарту ISO 9001;
- Лицензия ФСБ на осуществление работ с использованием сведений, составляющих государственную тайну;
- Поставка специализированных компонентов (Xilinx, Altera, Analog Devices, Intersil, Interpoint, Microsemi, Aeroflex, Peregrine, Syfer, Eurofarad, Texas Instrument, Miteq, Cobham, E2V, MA-COM, Hittite, Mini-Circuits, General Dynamics и др.);

Помимо этого, одним из направлений компании «ЭлектроПласт» является направление «Источники питания». Мы предлагаем Вам помощь Конструкторского отдела:

- Подбор оптимального решения, техническое обоснование при выборе компонента;
- Подбор аналогов;
- Консультации по применению компонента;
- Поставка образцов и прототипов;
- Техническая поддержка проекта;
- Защита от снятия компонента с производства.



Как с нами связаться

Телефон: 8 (812) 309 58 32 (многоканальный)

Факс: 8 (812) 320-02-42

Электронная почта: org@eplast1.ru

Адрес: 198099, г. Санкт-Петербург, ул. Калинина, дом 2, корпус 4, литера А.