

## 1.5A, Low Voltage, Low Quiescent Current LDO Regulator

### Features

- 1.5A Output Current Capability
- Input Operating Voltage Range: 2.3V to 6.0V
- Adjustable Output Voltage Range: 0.8V to 5.0V
- Standard Fixed Output Voltages:
  - 0.8V, 1.2V, 1.8V, 2.5V, 3.0V, 3.3V, 5.0V
- Other Fixed Output Voltage Options Available Upon Request
- Low Dropout Voltage: 330 mV Typical at 1.5A
- Typical Output Voltage Tolerance: 0.5%
- Stable with 1.0  $\mu$ F Ceramic Output Capacitor
- Fast response to Load Transients
- Low Supply Current: 120  $\mu$ A (typ)
- Low Shutdown Supply Current: 0.1  $\mu$ A (typ)
- Adjustable Delay on Power Good Output
- Short Circuit Current Limiting and Overtemperature Protection
- 3x3 DFN-8 and SOIC-8 Package Options

### Applications

- High-Speed Driver Chipset Power
- Networking Backplane Cards
- Notebook Computers
- Network Interface Cards
- Palmtop Computers
- 2.5V to 1.XV Regulators

### Description

The MCP1727 is a 1.5A Low Dropout (LDO) linear regulator that provides high current and low output voltages in a very small package. The MCP1727 comes in a fixed (or adjustable) output voltage version, with an output voltage range of 0.8V to 5.0V. The 1.5A output current capability, combined with the low output voltage capability, make the MCP1727 a good choice for new sub-1.8V output voltage LDO applications that have high current demands.

The MCP1727 is stable using ceramic output capacitors that inherently provide lower output noise and reduce the size and cost of the entire regulator solution. Only 1  $\mu$ F of output capacitance is needed to stabilize the LDO.

Using CMOS construction, the quiescent current consumed by the MCP1727 is typically less than 120  $\mu$ A over the entire input voltage range, making it attractive for portable computing applications that demand high output current. When shut down, the quiescent current is reduced to less than 0.1  $\mu$ A.

The scaled-down output voltage is internally monitored and a power good (PWRGD) output is provided when the output is within 92% of regulation (typical). An external capacitor can be used on the C<sub>DELAY</sub> pin to adjust the delay from 200  $\mu$ s to 300 ms.

The overtemperature and short circuit current-limiting provide additional protection for the LDO during system fault conditions.

### Package Types

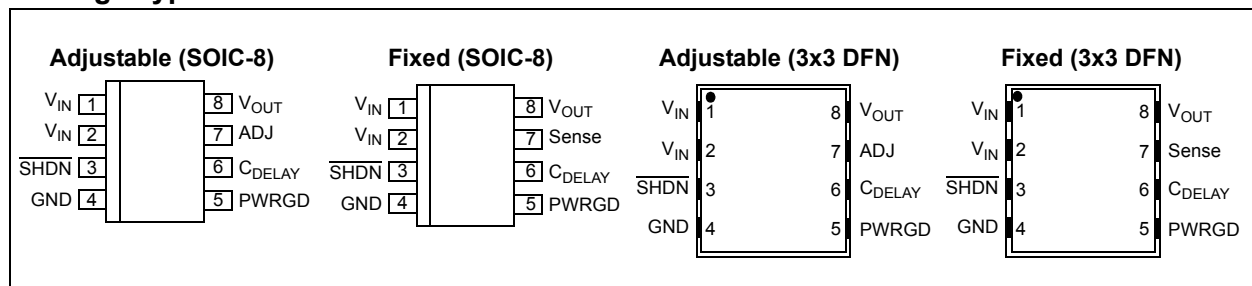

# MCP1727

## Typical Application

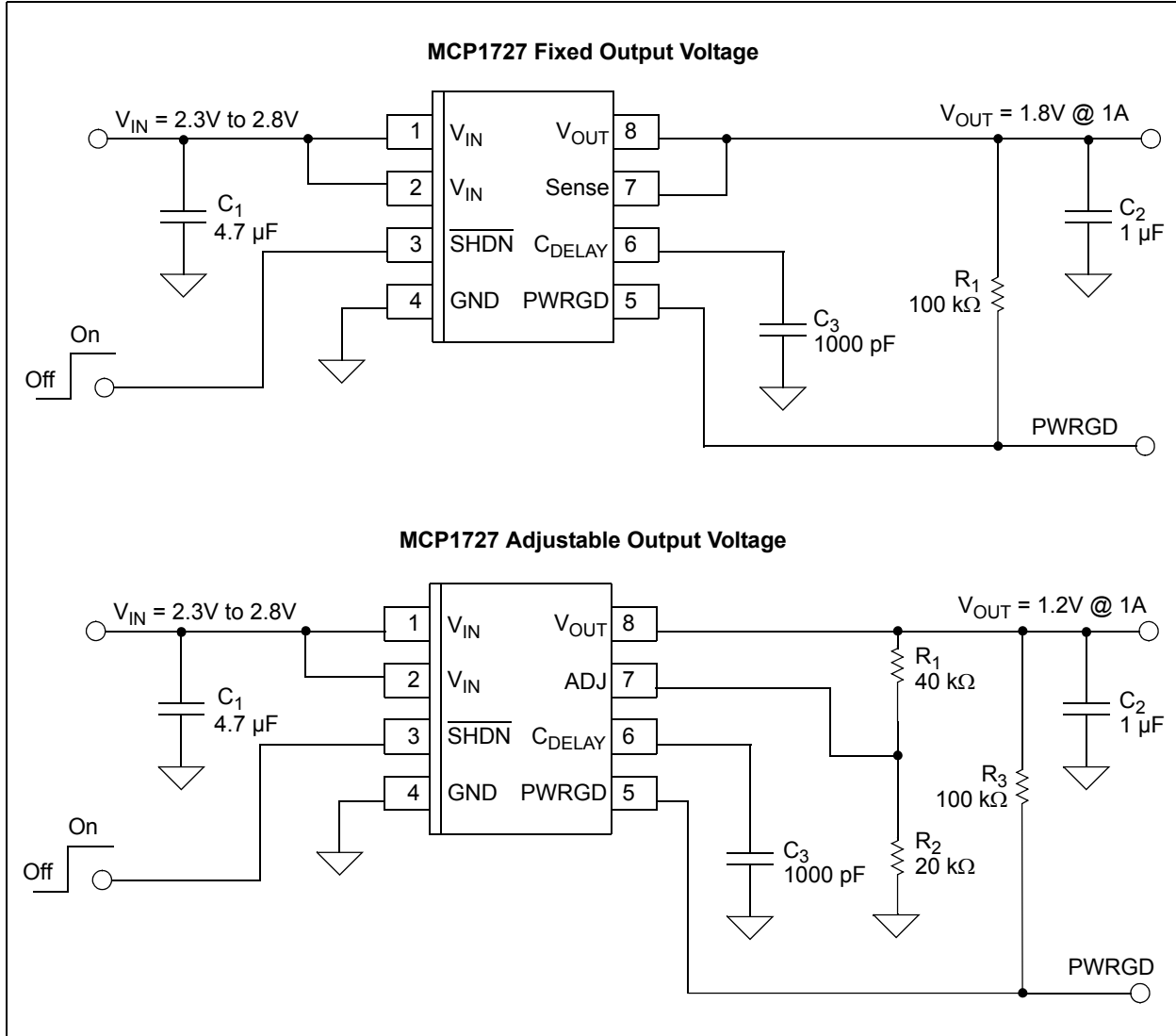

Functional Block Diagram - Adjustable Output

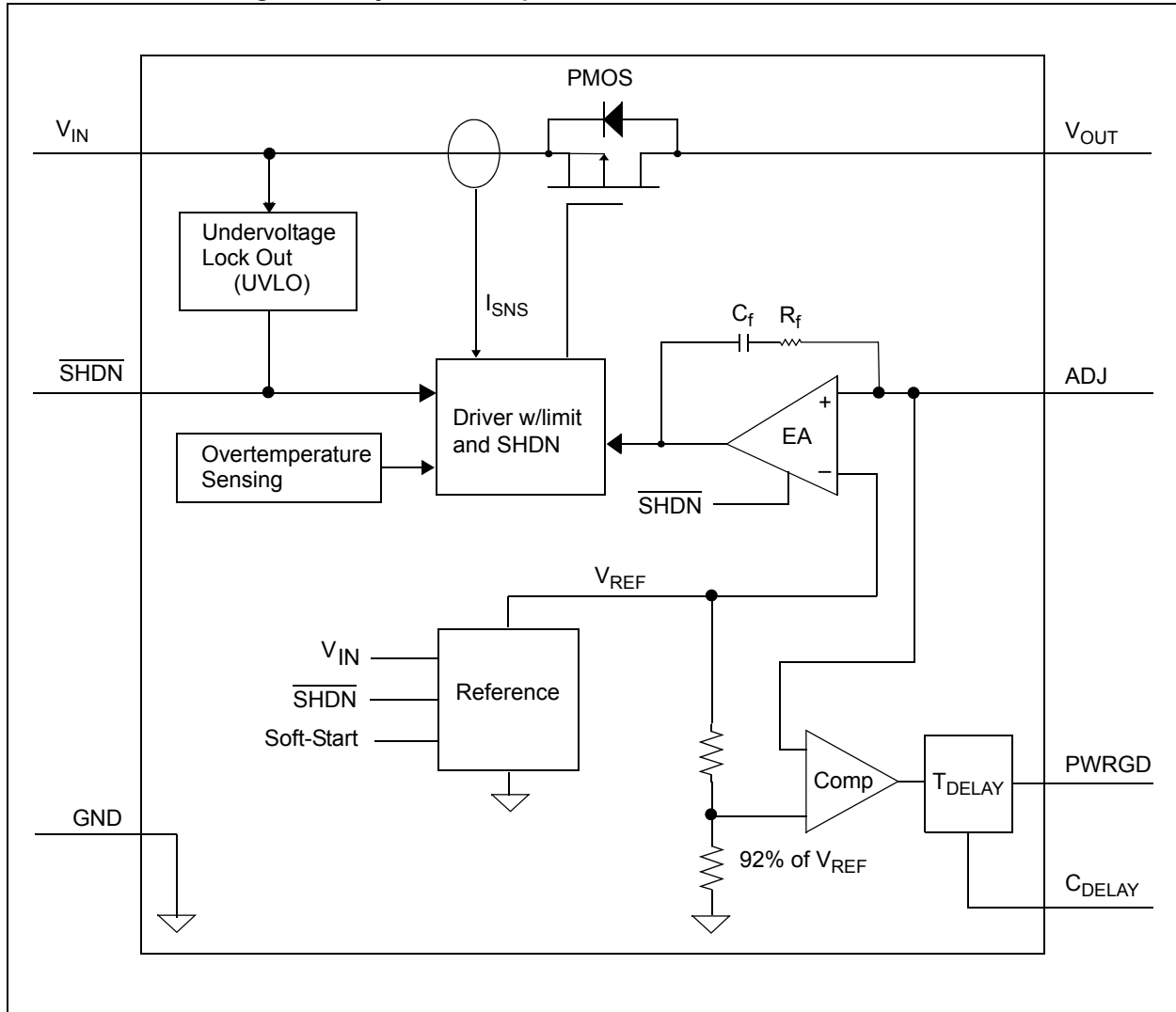

# MCP1727

## Functional Block Diagram - Fixed Output



## 1.0 ELECTRICAL CHARACTERISTICS

### Absolute Maximum Ratings †

$V_{IN}$ .....	6.5V
Maximum Voltage on Any Pin ..(GND – 0.3V) to ( $V_{DD}$ + 0.3)V	
Maximum Power Dissipation.....	Internally-Limited ( <b>Note 6</b> )
Output Short Circuit Duration.....	Continuous
Storage temperature .....	-65°C to +150°C
Maximum Junction Temperature, $T_J$ .....	+150°C
ESD protection on all pins (HBM/MM) .....	$\geq 2$ kV; $\geq 200$ V

† **Notice:** Stresses above those listed under “Maximum Ratings” may cause permanent damage to the device. This is a stress rating only and functional operation of the device at those or any other conditions above those indicated in the operational listings of this specification is not implied. Exposure to maximum rating conditions for extended periods may affect device reliability.

### AC/DC CHARACTERISTICS

**Electrical Specifications:** Unless otherwise noted,  $V_{IN} = V_{OUT(MAX)} + V_{DROPOUT(MAX)}$  (**Note 1**),  $V_R = 1.8$ V for Adjustable Output,  $I_{OUT} = 1$  mA,  $C_{IN} = C_{OUT} = 4.7$   $\mu$ F (X7R Ceramic),  $T_A = +25^\circ$ C.  
**Boldface** type applies for junction temperatures,  $T_J$  (**Note 7**) of **-40°C to +125°C**

Parameters	Sym	Min	Typ	Max	Units	Conditions
Input Operating Voltage	$V_{IN}$	<b>2.3</b>		<b>6.0</b>	V	<b>Note 1</b>
Input Quiescent Current	$I_q$	—	120	<b>220</b>	$\mu$ A	$I_L = 0$ mA, $V_{IN} =$ <b>Note 1</b> , $V_{OUT} = 0.8$ V to 5.0V
Input Quiescent Current for SHDN Mode	$I_{SHDN}$	—	0.1	<b>3</b>	$\mu$ A	SHDN = GND
Maximum Output Current	$I_{OUT}$	<b>1.5</b>	—	—	A	$V_{IN} = 2.3$ V to 6.0V $V_R = 0.8$ V to 5.0V, <b>Note 1</b>
Line Regulation	$\frac{\Delta V_{OUT}}{V_{OUT} \times \Delta V_{IN}}$	—	0.05	<b>0.16</b>	%/V	<b>(Note 1)</b> $\leq V_{IN} \leq 6$ V
Load Regulation	$\Delta V_{OUT}/V_{OUT}$	<b>-1.0</b>	$\pm 0.5$	<b>1.0</b>	%	$I_{OUT} = 1$ mA to 1.5A, $V_{IN} =$ <b>Note 1</b> , ( <b>Note 4</b> )
Output Short Circuit Current	$I_{OUT\_SC}$	—	2.2	—	A	$V_{IN} =$ <b>Note 1</b> , $R_{LOAD} < 0.1\Omega$ , Peak Current
<b>Adjust Pin Characteristics (Adjustable Output Only)</b>						
Adjust Pin Reference Voltage	$V_{ADJ}$	<b>0.402</b>	0.410	<b>0.418</b>	V	$V_{IN} = 2.3$ V to $V_{IN} = 6.0$ V, $I_{OUT} = 1$ mA
Adjust Pin Leakage Current	$I_{ADJ}$	-10	$\pm 0.01$	+10	nA	$V_{IN} = 6.0$ V, $V_{ADJ} = 0$ V to 6V
Adjust Temperature Coefficient	$TCV_{OUT}$	—	40	—	ppm/°C	<b>Note 3</b>
<b>Fixed-Output Characteristics (Fixed Output Only)</b>						
Voltage Regulation	$V_{OUT}$	<b><math>V_R - 2.5\%</math></b>	$V_R$ $\pm 0.5\%$	<b><math>V_R + 2.5\%</math></b>	V	<b>Note 2</b>

- Note 1:** The minimum  $V_{IN}$  must meet two conditions:  $V_{IN} \geq 2.3$ V and  $V_{IN} \geq V_{OUT(MAX)} + V_{DROPOUT(MAX)}$ .
- 2:**  $V_R$  is the nominal regulator output voltage for the fixed cases.  $V_R = 1.2$ V, 1.8V, etc.  $V_R$  is the desired set point output voltage for the adjustable cases.  $V_R = V_{ADJ} \cdot ((R_1/R_2)+1)$ . **Figure 4-1**.
- 3:**  $TCV_{OUT} = (V_{OUT-HIGH} - V_{OUT-LOW}) \cdot 10^6 / (V_R \cdot \Delta Temperature)$ .  $V_{OUT-HIGH}$  is the highest voltage measured over the temperature range.  $V_{OUT-LOW}$  is the lowest voltage measured over the temperature range.
- 4:** Load regulation is measured at a constant junction temperature using low duty-cycle pulse testing. Load regulation is tested over a load range from 1 mA to the maximum specified output current.
- 5:** Dropout voltage is defined as the input-to-output voltage differential at which the output voltage drops 2% below its nominal value that was measured with an input voltage of  $V_{OUT} = V_R + V_{DROPOUT(MAX)}$ .
- 6:** The maximum allowable power dissipation is a function of ambient temperature, the maximum allowable junction temperature and the thermal resistance from junction to air. (i.e.,  $T_A$ ,  $T_J$ ,  $\theta_{JA}$ ). Exceeding the maximum allowable power dissipation will cause the device operating junction temperature to exceed the maximum +150°C rating. Sustained junction temperatures above 150°C can impact device reliability.
- 7:** The junction temperature is approximated by soaking the device under test at an ambient temperature equal to the desired junction temperature. The test time is small enough such that the rise in the junction temperature over the ambient temperature is not significant.

# MCP1727

## AC/DC CHARACTERISTICS (CONTINUED)

<b>Electrical Specifications:</b> Unless otherwise noted, $V_{IN} = V_{OUT(MAX)} + V_{DROPOUT(MAX)}$ ( <b>Note 1</b> ), $V_R = 1.8V$ for Adjustable Output, $I_{OUT} = 1\text{ mA}$ , $C_{IN} = C_{OUT} = 4.7\text{ }\mu\text{F}$ (X7R Ceramic), $T_A = +25^\circ\text{C}$ . <b>Boldface type applies for junction temperatures, <math>T_J</math> (<b>Note 7</b>) of <math>-40^\circ\text{C}</math> to <math>+125^\circ\text{C}</math></b>						
Parameters	Sym	Min	Typ	Max	Units	Conditions
<b>Dropout Characteristics</b>						
Dropout Voltage	$V_{IN} - V_{OUT}$	—	330	<b>550</b>	mV	<b>Note 5</b> , $I_{OUT} = 1.5A$ , $V_{IN(MIN)} = 2.3V$
<b>Power Good Characteristics</b>						
PWRGD Input Voltage Operating Range	$V_{PWRGD\_VIN}$	1.0 <b>1.2</b>	—	6.0 <b>6.0</b>	V	$T_A = +25^\circ\text{C}$ $T_A = -40^\circ\text{C}$ to $+125^\circ\text{C}$ For $V_{IN} < 2.3V$ , $I_{SINK} = 100\text{ }\mu\text{A}$
PWRGD Threshold Voltage (Referenced to $V_{OUT}$ )	$V_{PWRGD\_TH}$	— <b>89</b> <b>90</b>	— 92 92	— <b>95</b> <b>94</b>	% $V_{OUT}$	Falling Edge $V_{OUT} < 2.5V$ Fixed, $V_{OUT} = \text{Adj.}$ $V_{OUT} \geq 2.5V$ Fixed
PWRGD Threshold Hysteresis	$V_{PWRGD\_HYS}$	<b>1.0</b>	2.0	<b>3.0</b>	% $V_{OUT}$	
PWRGD Output Voltage Low	$V_{PWRGD\_L}$	—	0.2	<b>0.4</b>	V	$I_{PWRGD\_SINK} = 1.2\text{ mA}$ , $ADJ = 0V$ , $SENSE = 0V$
PWRGD Leakage	$P_{PWRGD\_LK}$	—	1	—	nA	$V_{PWRGD} = V_{IN} = 6.0V$
PWRGD Time Delay	$T_{PG}$	— <b>10</b> —	200 30 300	— <b>55</b> —	$\mu\text{s}$ ms ms	Rising Edge $R_{PULLUP} = 10\text{ k}\Omega$ $I_{CDELAY} = 140\text{ nA}$ (Typ) $C_{DELAY} = \text{OPEN}$ $C_{DELAY} = 0.01\text{ }\mu\text{F}$ $C_{DELAY} = 0.1\text{ }\mu\text{F}$
Detect Threshold to PWRGD Active Time Delay	$T_{VDET-PWRGD}$	—	200	—	$\mu\text{s}$	$V_{ADJ}$ or $V_{SENSE} = V_{PWRGD\_TH} + 20\text{ mV}$ to $V_{PWRGD\_TH} - 20\text{ mV}$
<b>Shutdown Input</b>						
Logic High Input	$V_{SHDN-HIGH}$	<b>45</b>			% $V_{IN}$	$V_{IN} = 2.3V$ to $6.0V$
Logic Low Input	$V_{SHDN-LOW}$			<b>15</b>	% $V_{IN}$	$V_{IN} = 2.3V$ to $6.0V$
SHDN Input Leakage Current	$\overline{SHDN}_{ILK}$	<b>-0.1</b>	$\pm 0.001$	<b>+0.1</b>	$\mu\text{A}$	$V_{IN} = 6V$ , $\overline{SHDN} = V_{IN}$ , $\overline{SHDN} = \text{GND}$
<b>AC Performance</b>						
Output Delay From $\overline{SHDN}$	$T_{OR}$		100		$\mu\text{s}$	$\overline{SHDN} = \text{GND}$ to $V_{IN}$ $V_{OUT} = \text{GND}$ to $95\% V_R$

- Note 1:** The minimum  $V_{IN}$  must meet two conditions:  $V_{IN} \geq 2.3V$  and  $V_{IN} \geq V_{OUT(MAX)} + V_{DROPOUT(MAX)}$ .
- Note 2:**  $V_R$  is the nominal regulator output voltage for the fixed cases.  $V_R = 1.2V$ ,  $1.8V$ , etc.  $V_R$  is the desired set point output voltage for the adjustable cases.  $V_R = V_{ADJ} \cdot ((R_1/R_2)+1)$ . **Figure 4-1**.
- Note 3:**  $TCV_{OUT} = (V_{OUT-HIGH} - V_{OUT-LOW}) \cdot 10^6 / (V_R \cdot \Delta\text{Temperature})$ .  $V_{OUT-HIGH}$  is the highest voltage measured over the temperature range.  $V_{OUT-LOW}$  is the lowest voltage measured over the temperature range.
- Note 4:** Load regulation is measured at a constant junction temperature using low duty-cycle pulse testing. Load regulation is tested over a load range from 1 mA to the maximum specified output current.
- Note 5:** Dropout voltage is defined as the input-to-output voltage differential at which the output voltage drops 2% below its nominal value that was measured with an input voltage of  $V_{OUT} = V_R + V_{DROPOUT(MAX)}$ .
- Note 6:** The maximum allowable power dissipation is a function of ambient temperature, the maximum allowable junction temperature and the thermal resistance from junction to air. (i.e.,  $T_A$ ,  $T_J$ ,  $\theta_{JA}$ ). Exceeding the maximum allowable power dissipation will cause the device operating junction temperature to exceed the maximum  $+150^\circ\text{C}$  rating. Sustained junction temperatures above  $150^\circ\text{C}$  can impact device reliability.
- Note 7:** The junction temperature is approximated by soaking the device under test at an ambient temperature equal to the desired junction temperature. The test time is small enough such that the rise in the junction temperature over the ambient temperature is not significant.

## AC/DC CHARACTERISTICS (CONTINUED)

**Electrical Specifications:** Unless otherwise noted,  $V_{IN} = V_{OUT(MAX)} + V_{DROPOUT(MAX)}$  (**Note 1**),  $V_R = 1.8V$  for Adjustable Output,  $I_{OUT} = 1\text{ mA}$ ,  $C_{IN} = C_{OUT} = 4.7\text{ }\mu\text{F}$  (X7R Ceramic),  $T_A = +25^\circ\text{C}$ .

**Boldface type applies for junction temperatures,  $T_J$  (**Note 7**) of  $-40^\circ\text{C}$  to  $+125^\circ\text{C}$**

Parameters	Sym	Min	Typ	Max	Units	Conditions
Output Noise	$e_N$	—	2.0	—	$\mu\text{V}/\sqrt{\text{Hz}}$	$I_{OUT} = 200\text{ mA}$ , $f = 1\text{ kHz}$ , $C_{OUT} = 10\text{ }\mu\text{F}$ (X7R Ceramic), $V_{OUT} = 2.5V$
Power Supply Ripple Rejection Ratio	PSRR	—	60	—	dB	$f = 100\text{ Hz}$ , $C_{OUT} = 10\text{ }\mu\text{F}$ , $I_{OUT} = 10\text{ mA}$ , $V_{INAC} = 30\text{ mV pk-pk}$ , $C_{IN} = 0\text{ }\mu\text{F}$
Thermal Shutdown Temperature	$T_{SD}$	—	150	—	$^\circ\text{C}$	$I_{OUT} = 100\text{ }\mu\text{A}$ , $V_{OUT} = 1.8V$ , $V_{IN} = 2.8V$
Thermal Shutdown Hysteresis	$\Delta T_{SD}$	—	10	—	$^\circ\text{C}$	$I_{OUT} = 100\text{ }\mu\text{A}$ , $V_{OUT} = 1.8V$ , $V_{IN} = 2.8V$

- Note 1:** The minimum  $V_{IN}$  must meet two conditions:  $V_{IN} \geq 2.3V$  and  $V_{IN} \geq V_{OUT(MAX)} + V_{DROPOUT(MAX)}$ .
- 2:**  $V_R$  is the nominal regulator output voltage for the fixed cases.  $V_R = 1.2V$ ,  $1.8V$ , etc.  $V_R$  is the desired set point output voltage for the adjustable cases.  $V_R = V_{ADJ} \cdot ((R_1/R_2)+1)$ . [Figure 4-1](#).
- 3:**  $TCV_{OUT} = (V_{OUT-HIGH} - V_{OUT-LOW}) \cdot 10^6 / (V_R \cdot \Delta\text{Temperature})$ .  $V_{OUT-HIGH}$  is the highest voltage measured over the temperature range.  $V_{OUT-LOW}$  is the lowest voltage measured over the temperature range.
- 4:** Load regulation is measured at a constant junction temperature using low duty-cycle pulse testing. Load regulation is tested over a load range from 1 mA to the maximum specified output current.
- 5:** Dropout voltage is defined as the input-to-output voltage differential at which the output voltage drops 2% below its nominal value that was measured with an input voltage of  $V_{OUT} = V_R + V_{DROPOUT(MAX)}$ .
- 6:** The maximum allowable power dissipation is a function of ambient temperature, the maximum allowable junction temperature and the thermal resistance from junction to air. (i.e.,  $T_A$ ,  $T_J$ ,  $\theta_{JA}$ ). Exceeding the maximum allowable power dissipation will cause the device operating junction temperature to exceed the maximum  $+150^\circ\text{C}$  rating. Sustained junction temperatures above  $150^\circ\text{C}$  can impact device reliability.
- 7:** The junction temperature is approximated by soaking the device under test at an ambient temperature equal to the desired junction temperature. The test time is small enough such that the rise in the junction temperature over the ambient temperature is not significant.

## TEMPERATURE SPECIFICATIONS

**Electrical Specifications:** Unless otherwise indicated, all limits apply for  $V_{IN} = 2.3V$  to  $6.0V$ .

Parameters	Sym	Min	Typ	Max	Units	Conditions
<b>Temperature Ranges</b>						
Operating Junction Temperature Range	$T_J$	-40	—	+125	$^\circ\text{C}$	Steady State
Maximum Junction Temperature	$T_J$	—	—	+150	$^\circ\text{C}$	Transient
Storage Temperature Range	$T_A$	-65	—	+150	$^\circ\text{C}$	
<b>Thermal Package Resistances</b>						
Thermal Resistance, 8LD 3x3 DFN	$\theta_{JA}$	—	41	—	$^\circ\text{C}/\text{W}$	4-Layer JC51-7 Standard Board with vias
Thermal Resistance, 8LD SOIC	$\theta_{JA}$	—	150	—	$^\circ\text{C}/\text{W}$	4-Layer JC51-7 Standard Board

# MCP1727

## 2.0 TYPICAL PERFORMANCE CURVES

**Note:** The graphs and tables provided following this note are a statistical summary based on a limited number of samples and are provided for informational purposes only. The performance characteristics listed herein are not tested or guaranteed. In some graphs or tables, the data presented may be outside the specified operating range (e.g., outside specified power supply range) and therefore outside the warranted range.

**NOTE:** Unless otherwise indicated  $V_{OUT} = 1.8V$  (Adjustable),  $V_{IN} = 2.8V$ ,  $C_{OUT} = 4.7 \mu F$  Ceramic (X7R),  $C_{IN} = 4.7 \mu F$  Ceramic (X7R),  $I_{OUT} = 1 mA$ , Temperature =  $+25^{\circ}C$ ,  $V_{IN} = V_{OUT} + 0.6V$ ,  $RPWRGD = 10 k\Omega$  To  $V_{IN}$ .

**NOTE:** Junction Temperature ( $T_J$ ) is approximated by soaking the device under test to an ambient temperature equal to the desired Junction temperature. The test time is small enough such that the rise in Junction temperature over the Ambient temperature is not significant.

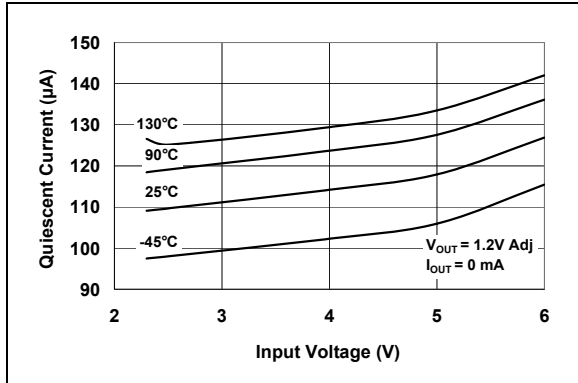

**FIGURE 2-1:** Quiescent Current vs. Input Voltage (1.2V Adjustable).

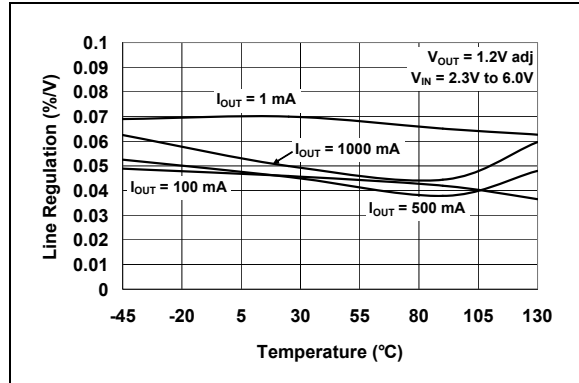

**FIGURE 2-4:** Line Regulation vs. Temperature (1.2V Adjustable).

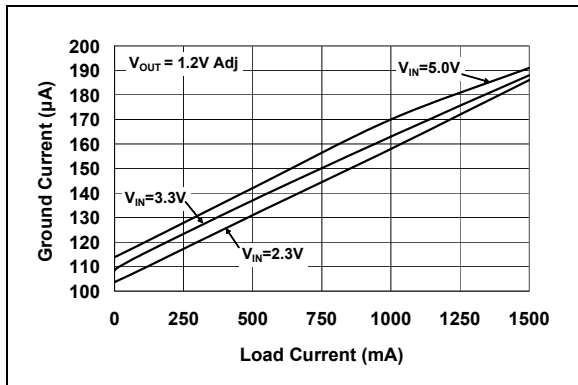

**FIGURE 2-2:** Ground Current vs. Load Current (1.2V Adjustable).

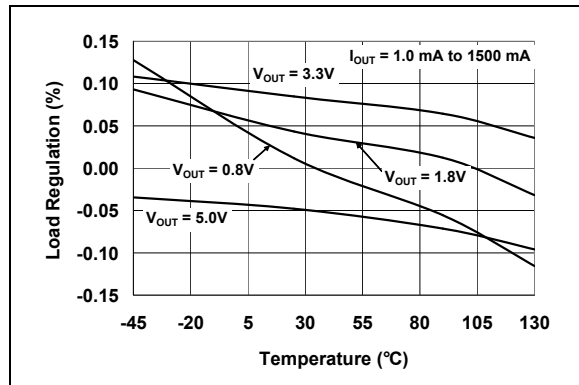

**FIGURE 2-5:** Load Regulation vs. Temperature.



**FIGURE 2-3:** Quiescent Current vs. Junction Temperature (1.2V Adjustable).



**FIGURE 2-6:** Adjust Pin Voltage vs. Temperature.



**NOTE:** Unless otherwise indicated  $V_{OUT} = 1.8V$  (Adjustable),  $V_{IN} = 2.8V$ ,  $C_{OUT} = 4.7 \mu F$  Ceramic (X7R),  $C_{IN} = 4.7 \mu F$  Ceramic (X7R),  $I_{OUT} = 1 \text{ mA}$ , Temperature =  $+25^\circ C$ ,  $V_{IN} = V_{OUT} + 0.6V$ ,  $RPWRGD = 10 \text{ k}\Omega$  To  $V_{IN}$ .



**FIGURE 2-7:** Dropout Voltage vs. Load Current (Adjustable Version).



**FIGURE 2-10:** Quiescent Current vs. Input Voltage (0.8V Fixed).



**FIGURE 2-8:** Dropout Voltage vs. Temperature (Adjustable Version).



**FIGURE 2-11:** Quiescent Current vs. Input Voltage (2.5V Fixed).



**FIGURE 2-9:** Power Good (PWRGD) Time Delay vs. Temperature.



**FIGURE 2-12:** Ground Current vs. Load Current.

# MCP1727

**NOTE:** Unless otherwise indicated  $V_{OUT} = 1.8V$  (Adjustable),  $V_{IN} = 2.8V$ ,  $C_{OUT} = 4.7 \mu F$  Ceramic (X7R),  $C_{IN} = 4.7 \mu F$  Ceramic (X7R),  $I_{OUT} = 1 \text{ mA}$ , Temperature =  $+25^\circ C$ ,  $V_{IN} = V_{OUT} + 0.6V$ ,  $RPWRGD = 10 \text{ k}\Omega$  To  $V_{IN}$ .

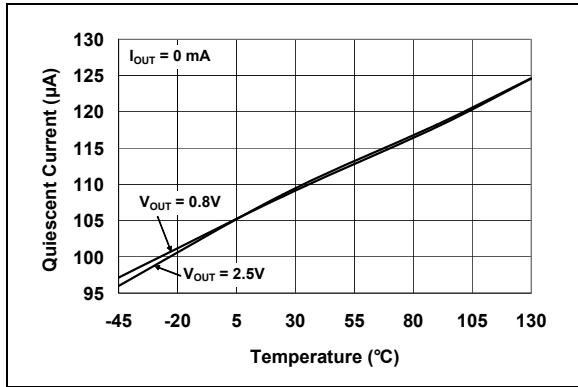

**FIGURE 2-13:** Quiescent Current vs. Temperature.

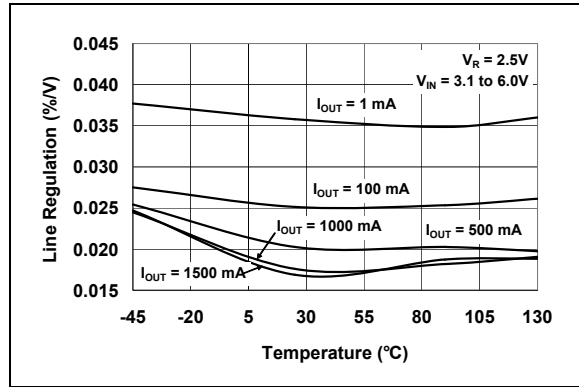

**FIGURE 2-16:** Line Regulation vs. Temperature (2.5V Fixed).

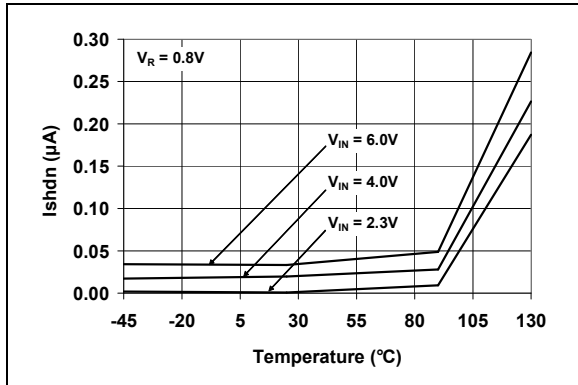

**FIGURE 2-14:**  $I_{SHDN}$  vs. Temperature.

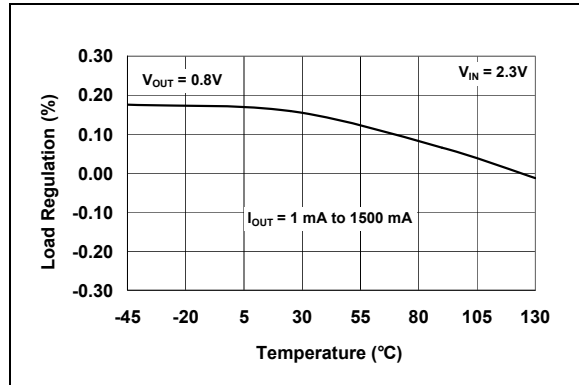

**FIGURE 2-17:** Load Regulation vs. Temperature ( $V_{OUT} < 2.5V$  Fixed).

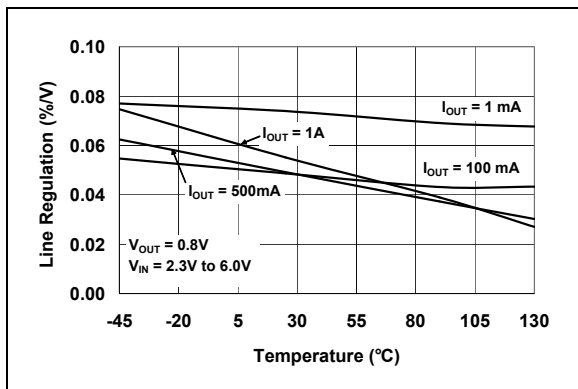

**FIGURE 2-15:** Line Regulation vs. Temperature (0.8V Fixed).

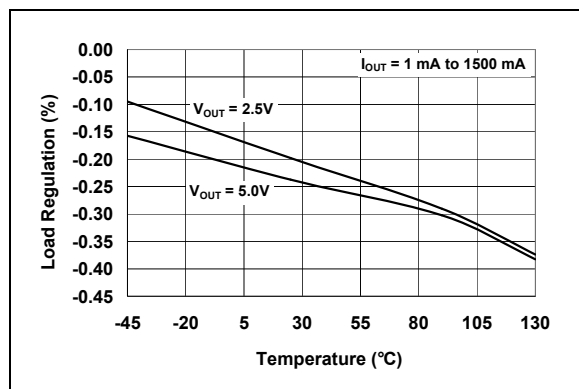

**FIGURE 2-18:** Load Regulation vs. Temperature ( $V_{OUT} \geq 2.5V$  Fixed).

**NOTE:** Unless otherwise indicated  $V_{OUT} = 1.8V$  (Adjustable),  $V_{IN} = 2.8V$ ,  $C_{OUT} = 4.7 \mu F$  Ceramic (X7R),  $C_{IN} = 4.7 \mu F$  Ceramic (X7R),  $I_{OUT} = 1 \text{ mA}$ , Temperature =  $+25^\circ C$ ,  $V_{IN} = V_{OUT} + 0.6V$ ,  $RPWRGD = 10 \text{ k}\Omega$  To  $V_{IN}$ .



**FIGURE 2-19:** Dropout Voltage vs. Load Current.



**FIGURE 2-22:** Output Noise Voltage Density vs. Frequency.



**FIGURE 2-20:** Dropout Voltage vs. Temperature.



**FIGURE 2-23:** Power Supply Ripple Rejection (PSRR) vs. Frequency ( $V_{OUT} = 1.2V$  Adj.).



**FIGURE 2-21:** Short Circuit Current vs. Input Voltage.



**FIGURE 2-24:** Power Supply Ripple Rejection (PSRR) vs. Frequency ( $V_{OUT} = 1.2V$  Adj.).

# MCP1727

**NOTE:** Unless otherwise indicated  $V_{OUT} = 1.8V$  (Adjustable),  $V_{IN} = 2.8V$ ,  $C_{OUT} = 4.7 \mu F$  Ceramic (X7R),  $C_{IN} = 4.7 \mu F$  Ceramic (X7R),  $I_{OUT} = 1 \text{ mA}$ , Temperature =  $+25^\circ C$ ,  $V_{IN} = V_{OUT} + 0.6V$ ,  $RPWRGD = 10 \text{ k}\Omega$  To  $V_{IN}$ .



**FIGURE 2-25:** Power Supply Ripple Rejection (PSRR) vs. Frequency ( $V_{OUT} = 2.5V$  Fixed).



**FIGURE 2-28:** 2.5V (Fixed) Startup from Shutdown.



**FIGURE 2-26:** Power Supply Ripple Rejection (PSRR) vs. Frequency ( $V_{OUT} = 2.5V$  Fixed).



**FIGURE 2-29:** Power Good (PWRGD) Timing with  $C_{BYPASS}$  of 1000 pF.



**FIGURE 2-27:** 2.5V (Fixed) Startup from  $V_{IN}$ .



**FIGURE 2-30:** Power Good (PWRGD) Timing with  $C_{BYPASS}$  of 0.1  $\mu F$ .

**NOTE:** Unless otherwise indicated  $V_{OUT} = 1.8V$  (Adjustable),  $V_{IN} = 2.8V$ ,  $C_{OUT} = 4.7 \mu F$  Ceramic (X7R),  $C_{IN} = 4.7 \mu F$  Ceramic (X7R),  $I_{OUT} = 1 \text{ mA}$ , Temperature =  $+25^\circ C$ ,  $V_{IN} = V_{OUT} + 0.6V$ ,  $RPWRGD = 10 \text{ k}\Omega$  To  $V_{IN}$ .



**FIGURE 2-31:** Dynamic Line Response (0.8V Fixed).



**FIGURE 2-33:** Dynamic Load Response (2.5V Fixed, 10 mA to 1000 mA).

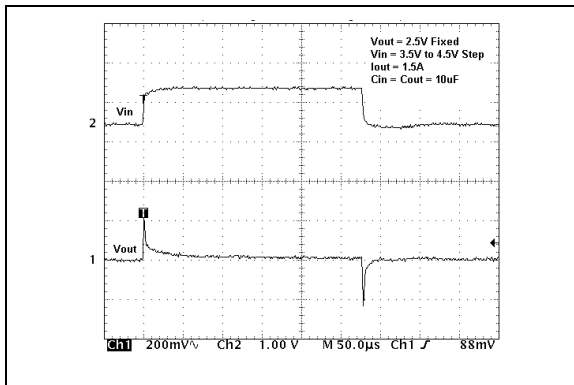

**FIGURE 2-32:** Dynamic Line Response (2.5V Fixed).

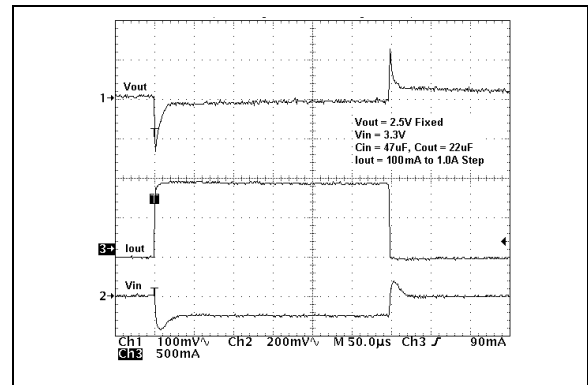

**FIGURE 2-34:** Dynamic Load Response (2.5V Fixed, 100 mA to 1000 mA).

# MCP1727

## 3.0 PIN DESCRIPTION

The descriptions of the pins are listed in Table 3-1.

TABLE 3-1: PIN FUNCTION TABLE

Fixed Output	Adjustable Output	Name	Description
1	1	$V_{IN}$	Input Voltage Supply
2	2	$V_{IN}$	Input Voltage Supply
3	3	$\overline{SHDN}$	Shutdown Control Input (active-low)
4	4	GND	Ground
5	5	PWRGD	Power Good Output (open-drain)
6	6	$C_{DELAY}$	Power Good Delay Set-Point Input
—	7	ADJ	Voltage Sense Input (adjustable version)
7	—	Sense	Voltage Sense Input (fixed voltage version)
8	8	$V_{OUT}$	Regulated Output Voltage
Exposed Pad	Exposed Pad	EP	Exposed Pad of the DFN Package (ground potential)

### 3.1 Input Voltage Supply ( $V_{IN}$ )

Connect the unregulated or regulated input voltage source to  $V_{IN}$ . If the input voltage source is located several inches away from the LDO, or the input source is a battery, it is recommended that an input capacitor be used. A typical input capacitance value of 1  $\mu\text{F}$  to 10  $\mu\text{F}$  should be sufficient for most applications.

### 3.2 Shutdown Control Input ( $\overline{SHDN}$ )

The  $\overline{SHDN}$  input is used to turn the LDO output voltage on and off. When the  $\overline{SHDN}$  input is at a logic-high level, the LDO output voltage is enabled. When the  $\overline{SHDN}$  input is pulled to a logic-low level, the LDO output voltage is disabled. When the  $\overline{SHDN}$  input is pulled low, the PWRGD output also goes low and the LDO enters a low quiescent current shutdown state where the typical quiescent current is 0.1  $\mu\text{A}$ .

### 3.3 Ground (GND)

Connect the GND pin of the LDO to a quiet circuit ground. This will help the LDO power supply rejection ratio and noise performance. The ground pin of the LDO only conducts the quiescent current of the LDO (typically 120  $\mu\text{A}$ ), so a heavy trace is not required. For applications have switching or noisy inputs tie the GND pin to the return of the output capacitor. Ground planes help lower inductance and voltage spikes caused by fast transient load currents and are recommended for applications that are subjected to fast load transients.

### 3.4 Power Good Output (PWRGD)

The PWRGD output is an open-drain output used to indicate when the LDO output voltage is within 92% (typically) of its nominal regulation value. The PWRGD threshold has a typical hysteresis value of 2%. The PWRGD output is typically delayed by 200  $\mu\text{s}$  (typical, no capacitance on  $C_{DELAY}$  pin) from the time the LDO output is within 92% + 3% (max hysteresis) of the regulated output value on power-up. This delay time is controlled by the  $C_{DELAY}$  pin.

### 3.5 Power Good Delay Set-Point Input ( $C_{DELAY}$ )

The  $C_{DELAY}$  input sets the power-up delay time for the PWRGD output. By connecting an external capacitor from the  $C_{DELAY}$  pin to ground, the typical delay times for the PWRGD output can be adjusted from 200  $\mu\text{s}$  (no capacitance) to 300 ms (0.1  $\mu\text{F}$  capacitor). This allows for the optimal setting of the system reset time.

### 3.6 Output Voltage Sense/Adjust Input (ADJ/Sense)

#### 3.6.1 ADJ

For adjustable applications, the output voltage is connected to the ADJ input through a resistor divider that sets the output voltage regulation value. This provides the user the capability to set the output voltage to any value they desire within the 0.8V to 5.0V range of the device.

## 3.6.2 Sense

For fixed output voltage versions of the device, the SENSE input is used to provide output voltage feedback to the internal circuitry of the MCP1727. The SENSE pin typically improves load regulation by allowing the device to compensate for voltage drops due to packaging and circuit board layout.

## 3.7 Regulated Output Voltage ( $V_{OUT}$ )

The  $V_{OUT}$  pin(s) is the regulated output voltage of the LDO. A minimum output capacitance of 1.0  $\mu$ F is required for LDO stability. The MCP1727 is stable with ceramic, tantalum and aluminum-electrolytic capacitors. See **Section 4.3 “Output Capacitor”** for output capacitor selection guidance.

## 3.8 Exposed Pad (EP)

The 3x3 DFN package has an exposed pad on the bottom of the package. This pad should be soldered to the Printed Circuit Board (PCB) to aid in the removal of heat from the package during operation. The exposed pad is at the ground potential of the LDO.

# MCP1727

## 4.0 DEVICE OVERVIEW

The MCP1727 is a high output current, Low Dropout (LDO) voltage regulator with an adjustable delay power-good output and shutdown control input. The low dropout voltage of 330 mV typical at 1.5A of current makes it ideal for battery-powered applications. Unlike other high output current LDOs, the MCP1727 only draws a maximum of 220  $\mu$ A of quiescent current.

### 4.1 LDO Output Voltage

The MCP1727 LDO is available with either a fixed output voltage or an adjustable output voltage. The output voltage range is 0.8V to 5.0V for both versions.

#### 4.1.1 ADJUST INPUT

The adjustable version of the MCP1727 uses the ADJ pin (pin 7) to get the output voltage feedback for output voltage regulation. This allows the user to set the output voltage of the device with two external resistors. The nominal voltage for ADJ is 0.41V.

Figure 4-1 shows the adjustable version of the MCP1727. Resistors  $R_1$  and  $R_2$  form the resistor divider network necessary to set the output voltage. With this configuration, the equation for setting  $V_{OUT}$  is:

#### EQUATION 4-1:

$$V_{OUT} = V_{ADJ} \left( \frac{R_1 + R_2}{R_2} \right)$$

Where:

$V_{OUT}$  = LDO Output Voltage

$V_{ADJ}$  = ADJ Pin Voltage (typically 0.41V)



**FIGURE 4-1:** Typical adjustable output voltage application circuit.

The allowable resistance value range for resistor  $R_2$  is from 10 k $\Omega$  to 200 k $\Omega$ . Solving the equation for  $R_1$  yields the following equation:

#### EQUATION 4-2:

$$R_1 = R_2 \left( \frac{V_{OUT} - V_{ADJ}}{V_{ADJ}} \right)$$

Where:

$V_{OUT}$  = LDO Output Voltage

$V_{ADJ}$  = ADJ Pin Voltage (typically 0.41V)

### 4.2 Output Current and Current Limiting

The MCP1727 LDO is tested and ensured to supply a minimum of 1.5A of output current. The MCP1727 has no minimum output load, so the output load current can go to 0 mA and the LDO will continue to regulate the output voltage to within tolerance.

The MCP1727 also incorporates an output current limit. If the output voltage falls below 0.7V due to an overload condition (usually represents a shorted load condition), the output current is limited to 2.2A (typical). If the overload condition is a soft overload, the MCP1727 will supply higher load currents of up to 3A. The MCP1727 should not be operated in this condition continuously as it may result in failure of the device. However, this does allow for device usage in applications that have higher pulsed load currents having an average output current value of 1.5A or less.

Output overload conditions may also result in an over-temperature shutdown of the device. If the junction temperature rises above 150°C, the LDO will shut down the output voltage. See Section 4.9 “Overtemperature Protection” for more information on overtemperature shutdown.

### 4.3 Output Capacitor

The MCP1727 requires a minimum output capacitance of 1  $\mu$ F for output voltage stability. Ceramic capacitors are recommended because of their size, cost and environmental robustness qualities.

Aluminum-electrolytic and tantalum capacitors can be used on the LDO output as well. The Equivalent Series Resistance (ESR) of the electrolytic output capacitor must be no greater than 1 ohm. The output capacitor should be located as close to the LDO output as is practical. Ceramic materials X7R and X5R have low temperature coefficients and are well within the acceptable ESR range required. A typical 1  $\mu$ F X7R 0805 capacitor has an ESR of 50 milli-ohms.

Larger LDO output capacitors can be used with the MCP1727 to improve dynamic performance and power supply ripple rejection performance. A maximum of 22  $\mu$ F is recommended. Aluminum-electrolytic capacitors are not recommended for low-temperature applications of  $\leq 25^\circ\text{C}$ .



#### 4.4 Input Capacitor

Low input source impedance is necessary for the LDO output to operate properly. When operating from batteries, or in applications with long lead length (> 10 inches) between the input source and the LDO, some input capacitance is recommended. A minimum of 1.0  $\mu\text{F}$  to 4.7  $\mu\text{F}$  is recommended for most applications.

For applications that have output step load requirements, the input capacitance of the LDO is very important. The input capacitance provides the LDO with a good local low-impedance source to pull the transient currents from in order to respond quickly to the output load step. For good step response performance, the input capacitor should be of equivalent (or higher) value than the output capacitor. The capacitor should be placed as close to the input of the LDO as is practical. Larger input capacitors will also help reduce any high-frequency noise on the input and output of the LDO and reduce the effects of any inductance that exists between the input source voltage and the input capacitance of the LDO.

#### 4.5 Power Good Output (PWRGD)

The PWRGD output is used to indicate when the output voltage of the LDO is within 92% (typical value, see **Section 1.0 “Electrical Characteristics”** for Minimum and Maximum specifications) of its nominal regulation value.

As the output voltage of the LDO rises, the PWRGD output will be held low until the output voltage has exceeded the power good threshold plus the hysteresis value. Once this threshold has been exceeded, the power good time delay is started (shown as  $T_{PG}$  in the Electrical Characteristics table). The power good time delay is adjustable via the  $C_{DELAY}$  pin of the LDO (see **Section 4.6 “ $C_{DELAY}$  Input”**). By placing a capacitor from the  $C_{DELAY}$  pin to ground, the power good time delay can be adjusted from 200  $\mu\text{s}$  (no capacitance) to 300 ms (0.1  $\mu\text{F}$  capacitor). After the time delay period, the PWRGD output will go high, indicating that the output voltage is stable and within regulation limits.

If the output voltage of the LDO falls below the power good threshold, the power good output will transition low. The power good circuitry has a 170  $\mu\text{s}$  delay when detecting a falling output voltage, which helps to increase noise immunity of the power good output and avoid false triggering of the power good output during fast output transients. See [Figure 4-2](#) for power good timing characteristics.

When the LDO is put into Shutdown mode using the  $\overline{\text{SHDN}}$  input, the power good output is pulled low immediately, indicating that the output voltage will be out of regulation. The timing diagram for the power good output when using the shutdown input is shown in [Figure 4-3](#).

The power good output is an open-drain output that can be pulled up to any voltage that is equal to or less than the LDO input voltage. This output is capable of sinking 1.2 mA ( $V_{PWRGD} < 0.4\text{V}$  maximum).

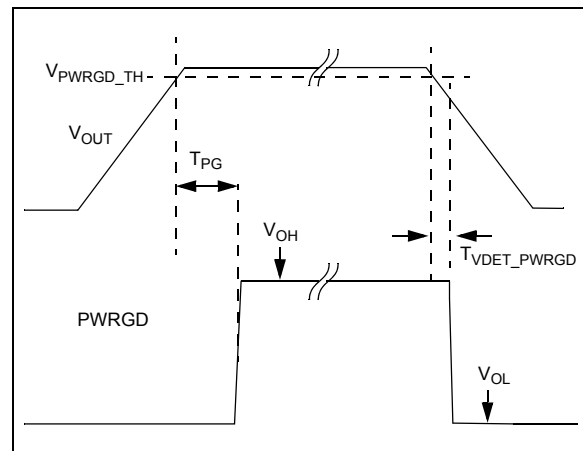

**FIGURE 4-2:** Power Good Timing.



**FIGURE 4-3:** Power Good Timing from Shutdown.

#### 4.6 $C_{DELAY}$ Input

The  $C_{DELAY}$  input is used to provide the power-up delay timing for the power good output, as discussed in the previous section. By adding a capacitor from the  $C_{DELAY}$  pin to ground, the PWRGD power-up time delay can be adjusted from 200  $\mu\text{s}$  (no capacitance on  $C_{DELAY}$ ) to 300 ms (0.1  $\mu\text{F}$  of capacitance on  $C_{DELAY}$ ). See **Section 1.0 “Electrical Characteristics”** for  $C_{DELAY}$  timing tolerances.

# MCP1727

Once the power good threshold (rising) has been reached, the  $C_{DELAY}$  pin charges the external capacitor to  $V_{IN}$ . The charging current is 140 nA (typical). The PWRGD output will transition high when the  $C_{DELAY}$  pin voltage has charged to 0.42V. If the output falls below the power good threshold limit during the charging time between 0.0V and 0.42V on the  $C_{DELAY}$  pin, the  $C_{DELAY}$  pin voltage will be pulled to ground, thus resetting the timer. The  $C_{DELAY}$  pin will be held low until the output voltage of the LDO has once again risen above the power good rising threshold. A timing diagram showing  $C_{DELAY}$ , PWRGD and  $V_{OUT}$  is shown in Figure 4-4.



**FIGURE 4-4:**  $C_{DELAY}$  and PWRGD Timing Diagram.

## 4.7 Shutdown Input (SHDN)

The  $\overline{SHDN}$  input is an active-low input signal that turns the LDO on and off. The SHDN threshold is a percentage of the input voltage. The typical value of this shutdown threshold is 30% of  $V_{IN}$ , with minimum and maximum limits over the entire operating temperature range of 45% and 15%, respectively.

The  $\overline{SHDN}$  input will ignore low-going pulses (pulses meant to shut down the LDO) that are up to 400 ns in pulse width. If the shutdown input is pulled low for more than 400 ns, the LDO will enter Shutdown mode. This small bit of filtering helps to reject any system noise spikes on the shutdown input signal.

On the rising edge of the  $\overline{SHDN}$  input, the shutdown circuitry has a 30  $\mu$ s delay before allowing the LDO output to turn on. This delay helps to reject any false turn-on signals or noise on the  $\overline{SHDN}$  input signal. After the 30  $\mu$ s delay, the LDO output enters its soft-start period as it rises from 0V to its final regulation value. If the  $\overline{SHDN}$  input signal is pulled low during the 30  $\mu$ s delay period, the timer will be reset and the delay time will start over again on the next rising edge of the  $\overline{SHDN}$  input. The total time from the  $\overline{SHDN}$  input going

high (turn-on) to the LDO output being in regulation is typically 100  $\mu$ s. See Figure 4-5 for a timing diagram of the  $\overline{SHDN}$  input.



**FIGURE 4-5:** Shutdown Input Timing Diagram.

## 4.8 Dropout Voltage and Undervoltage Lockout

Dropout voltage is defined as the input-to-output voltage differential at which the output voltage drops 2% below the nominal value that was measured with a  $V_R + 0.6V$  differential applied. The MCP1727 LDO has a very low dropout voltage specification of 330 mV (typical) at 1.5A of output current. See Section 1.0 “Electrical Characteristics” for maximum dropout voltage specifications.

The MCP1727 LDO operates across an input voltage range of 2.3V to 6.0V and incorporates input Undervoltage Lockout (UVLO) circuitry that keeps the LDO output voltage off until the input voltage reaches a minimum of 2.18V (typical) on the rising edge of the input voltage. As the input voltage falls, the LDO output will remain on until the input voltage level reaches 2.04V (typical).

Since the MCP1727 LDO undervoltage lockout activates at 2.04V as the input voltage is falling, the dropout voltage specification does not apply for output voltages that are less than 1.9V.

For high-current applications, voltage drops across the PCB traces must be taken into account. The trace resistances can cause significant voltage drops between the input voltage source and the LDO. For applications with input voltages near 2.3V, these PCB trace voltage drops can sometimes lower the input voltage enough to trigger a shutdown due to undervoltage lockout.

## 4.9 Overtemperature Protection

The MCP1727 LDO has temperature-sensing circuitry to prevent the junction temperature from exceeding approximately 150°C. If the LDO junction temperature does reach 150°C, the LDO output will be turned off until the junction temperature cools to approximately 140°C, at which point the LDO output will automatically resume normal operation. If the internal power dissipation continues to be excessive, the device will again shut off. The junction temperature of the die is a function of power dissipation, ambient temperature and package thermal resistance. See **Section 5.0 “Application Circuits/Issues”** for more information on LDO power dissipation and junction temperature.

# MCP1727

## 5.0 APPLICATION CIRCUITS/ ISSUES

### 5.1 Typical Application

The MCP1727 is used for applications that require high LDO output current and a power good output.



**FIGURE 5-1:** Typical Application Circuit.

#### 5.1.1 APPLICATION CONDITIONS

- Package Type = 3x3DFN8
- Input Voltage Range = 3.3V ± 5%
- V<sub>IN</sub> maximum = 3.465V
- V<sub>IN</sub> minimum = 3.135V
- V<sub>DROPOUT (max)</sub> = 0.525V
- V<sub>OUT</sub> (typical) = 2.5V
- I<sub>OUT</sub> = 1.5A maximum
- P<sub>DISS</sub> (typical) = 1.2W
- Temperature Rise = 49.2°C

## 5.2 Power Calculations

### 5.2.1 POWER DISSIPATION

The internal power dissipation within the MCP1727 is a function of input voltage, output voltage, output current and quiescent current. Equation 5-1 can be used to calculate the internal power dissipation for the LDO.

#### EQUATION 5-1:

$$P_{LDO} = (V_{IN(MAX)} - V_{OUT(MIN)}) \times I_{OUT(MAX)}$$

Where:

- P<sub>LDO</sub> = LDO Pass device internal power dissipation
- V<sub>IN(MAX)</sub> = Maximum input voltage
- V<sub>OUT(MIN)</sub> = LDO minimum output voltage

In addition to the LDO pass element power dissipation, there is power dissipation within the MCP1727 as a result of quiescent or ground current. The power dissipation as a result of the ground current can be calculated using the following equation:

#### EQUATION 5-2:

$$P_{I(GND)} = V_{IN(MAX)} \times I_{VIN}$$

Where:

- P<sub>I(GND)</sub> = Power dissipation due to the quiescent current of the LDO
- V<sub>IN(MAX)</sub> = Maximum input voltage
- I<sub>VIN</sub> = Current flowing in the V<sub>IN</sub> pin with no LDO output current (LDO quiescent current)

The total power dissipated within the MCP1727 is the sum of the power dissipated in the LDO pass device and the P<sub>I(GND)</sub> term. Because of the CMOS construction, the typical I<sub>GND</sub> for the MCP1727 is 120 μA. Operating at a maximum of 3.465V results in a power dissipation of 0.49 milli-Watts. For most applications, this is small compared to the LDO pass device power dissipation and can be neglected.

The maximum continuous operating junction temperature specified for the MCP1727 is +125°C. To estimate the internal junction temperature of the MCP1727, the total internal power dissipation is multiplied by the thermal resistance from junction to ambient (R<sub>θJA</sub>) of the device. The thermal resistance from junction to ambient for the 3x3 DFN package is estimated at 41° C/W.

#### EQUATION 5-3:

$$T_{J(MAX)} = P_{TOTAL} \times R_{\theta JA} + T_{AMAX}$$

- T<sub>J(MAX)</sub> = Maximum continuous junction temperature
- P<sub>TOTAL</sub> = Total device power dissipation
- R<sub>θJA</sub> = Thermal resistance from junction to ambient
- T<sub>AMAX</sub> = Maximum ambient temperature

The maximum power dissipation capability for a package can be calculated given the junction-to-ambient thermal resistance and the maximum ambient temperature for the application. Equation 5-4 can be used to determine the package maximum internal power dissipation.

#### EQUATION 5-4:

$$P_{D(MAX)} = \frac{(T_{J(MAX)} - T_{A(MAX)})}{R\theta_{JA}}$$

$P_{D(MAX)}$  = Maximum device power dissipation  
 $T_{J(MAX)}$  = maximum continuous junction temperature  
 $T_{A(MAX)}$  = maximum ambient temperature  
 $R\theta_{JA}$  = Thermal resistance from junction to ambient

#### EQUATION 5-5:

$$T_{J(RISE)} = P_{D(MAX)} \times R\theta_{JA}$$

$T_{J(RISE)}$  = Rise in device junction temperature over the ambient temperature  
 $P_{D(MAX)}$  = Maximum device power dissipation  
 $R\theta_{JA}$  = Thermal resistance from junction to ambient

#### EQUATION 5-6:

$$T_J = T_{J(RISE)} + T_A$$

$T_J$  = Junction temperature  
 $T_{J(RISE)}$  = Rise in device junction temperature over the ambient temperature  
 $T_A$  = Ambient temperature

## 5.3 Typical Application

Internal power dissipation, junction temperature rise, junction temperature and maximum power dissipation is calculated in the following example. The power dissipation as a result of ground current is small enough to be neglected.

### 5.3.1 POWER DISSIPATION EXAMPLE

#### Package

Package Type = 3x3DFN

#### Input Voltage

$V_{IN} = 3.3V \pm 5\%$

#### LDO Output Voltage and Current

$V_{OUT} = 2.5V$

$I_{OUT} = 1.5A$

#### Maximum Ambient Temperature

$T_{A(MAX)} = 60^\circ C$

#### Internal Power Dissipation

$P_{LDO(MAX)} = (V_{IN(MAX)} - V_{OUT(MIN)}) \times I_{OUT(MAX)}$

$P_{LDO} = ((3.3V \times 1.05) - (2.5V \times 0.975))$   
 $\times 1.5A$

$P_{LDO} = 1.54 \text{ Watts}$

#### 5.3.1.1 Device Junction Temperature Rise

The internal junction temperature rise is a function of internal power dissipation and the thermal resistance from junction-to-ambient for the application. The thermal resistance from junction-to-ambient ( $R\theta_{JA}$ ) is derived from an EIA/JEDEC standard for measuring thermal resistance for small surface-mount packages. The EIA/JEDEC specification is JESD51-7 "High Effective Thermal Conductivity Test Board for Leaded Surface-Mount Packages". The standard describes the test method and board specifications for measuring the thermal resistance from junction to ambient. The actual thermal resistance for a particular application can vary depending on many factors such as copper area and thickness. Refer to AN792, "A Method to Determine How Much Power a SOT23 Can Dissipate in an Application" (DS00792), for more information regarding this subject.

$T_{J(RISE)} = P_{TOTAL} \times R\theta_{JA}$

$T_{J(RISE)} = 1.54 \text{ W} \times 41.0^\circ \text{ C/W}$

$T_{J(RISE)} = 63.14^\circ C$

# MCP1727

## 5.3.1.2 Junction Temperature Estimate

To estimate the internal junction temperature, the calculated temperature rise is added to the ambient or offset temperature. For this example, the worst-case junction temperature is estimated below:

$$\begin{aligned}T_J &= T_{JRISE} + T_{A(MAX)} \\T_J &= 63.14^\circ\text{C} + 60.0^\circ\text{C} \\T_J &= 123.14^\circ\text{C}\end{aligned}$$

As you can see from the result, this application will be operating very near the maximum operating junction temperature of 125°C. The PCB layout for this application is very important as it has a significant impact on the junction-to-ambient thermal resistance ( $R_{\theta JA}$ ) of the 3x3 DFN package, which is very important in this application.

## 5.3.1.3 Maximum Package Power Dissipation at 60°C Ambient Temperature

### 3x3DFN (41° C/W $R_{\theta JA}$ ):

$$\begin{aligned}P_{D(MAX)} &= (125^\circ\text{C} - 60^\circ\text{C}) / 41^\circ\text{C/W} \\P_{D(MAX)} &= 1.585\text{W}\end{aligned}$$

### SOIC8 (150°C/Watt $R_{\theta JA}$ ):

$$\begin{aligned}P_{D(MAX)} &= (125^\circ\text{C} - 60^\circ\text{C}) / 150^\circ\text{C/W} \\P_{D(MAX)} &= 0.433\text{W}\end{aligned}$$

From this table, you can see the difference in maximum allowable power dissipation between the 3x3 DFN package and the 8-pin SOIC package. This difference is due to the exposed metal tab on the bottom of the DFN package. The exposed tab of the DFN package provides a very good thermal path from the die of the LDO to the PCB. The PCB then acts like a heatsink, providing more area to distribute the heat generated by the LDO.

## 5.4 $C_{DELAY}$ Calculations (typical)

$$C = I \cdot \frac{\Delta T}{\Delta V}$$

Where:

C	=	$C_{DELAY}$ Capacitor
I	=	$C_{DELAY}$ charging current, 140 nA typical.
$\Delta T$	=	time delay
$\Delta V$	=	$C_{DELAY}$ threshold voltage, 0.42V typical

$$C = I \cdot \frac{\Delta T}{\Delta V} = \frac{(140\text{nA} \cdot \Delta T)}{0.42\text{V}} = 333.3 \times 10^{-09} \cdot \Delta T$$

For a delay of 300 ms:

$$C = 333.3\text{E-09} \cdot .300$$

$$C = 100\text{E-09}\mu\text{F} (0.1 \mu\text{F})$$

## 6.0 PACKAGING INFORMATION

### 6.1 Package Marking Information

8-Lead DFN (3x3)

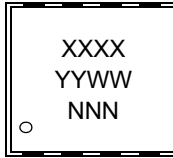

Standard			
Extended Temp			
Code	Voltage Options *	Code	Voltage Options *
CAAJ	0.8	CAAP	3.0
CAAK	1.2	CAAQ	3.3
CAAL	1.8	CAAR	5.0
CAAM	2.5	CAAH	ADJ

Example:

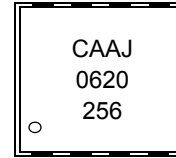

\* Custom output voltages available upon request. Contact your local Microchip sales office for more information.

8-Lead SOIC (150 mil)

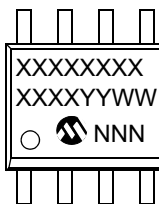

Standard			
Extended Temp			
Code	Voltage Options *	Code	Voltage Options *
082E	0.8	302E	3.0
122E	1.2	332E	3.3
182E	1.8	502E	5.0
252E	2.5	ADJE	ADJ

Example:

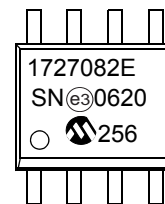

\* Custom output voltages available upon request. Contact your local Microchip sales office for more information.

<b>Legend:</b>	XX...X	Customer-specific information
	Y	Year code (last digit of calendar year)
	YY	Year code (last 2 digits of calendar year)
	WW	Week code (week of January 1 is week '01')
	NNN	Alphanumeric traceability code
	(e3)	Pb-free JEDEC designator for Matte Tin (Sn)
	*	This package is Pb-free. The Pb-free JEDEC designator (e3) can be found on the outer packaging for this package.

**Note:** In the event the full Microchip part number cannot be marked on one line, it will be carried over to the next line, thus limiting the number of available characters for customer-specific information.

# MCP1727

## 8-Lead Plastic Dual Flat, No Lead Package (MF) – 3x3x0.9 mm Body [DFN]

**Note:** For the most current package drawings, please see the Microchip Packaging Specification located at <http://www.microchip.com/packaging>

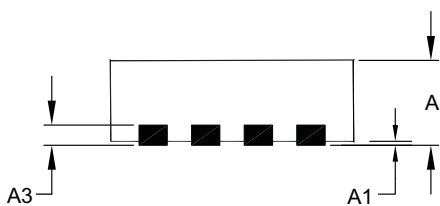

Dimension Limits	Units	MILLIMETERS		
		MIN	NOM	MAX
Number of Pins	N	8		
Pitch	e	0.65 BSC		
Overall Height	A	0.80	0.90	1.00
Standoff	A1	0.00	0.02	0.05
Contact Thickness	A3	0.20 REF		
Overall Length	D	3.00 BSC		
Exposed Pad Width	E2	0.00	–	1.60
Overall Width	E	3.00 BSC		
Exposed Pad Length	D2	0.00	–	2.40
Contact Width	b	0.25	0.30	0.35
Contact Length	L	0.20	0.30	0.55
Contact-to-Exposed Pad	K	0.20	–	–

**Notes:**

1. Pin 1 visual index feature may vary, but must be located within the hatched area.
2. Package may have one or more exposed tie bars at ends.
3. Package is saw singulated.
4. Dimensioning and tolerancing per ASME Y14.5M.

BSC: Basic Dimension. Theoretically exact value shown without tolerances.

REF: Reference Dimension, usually without tolerance, for information purposes only.

Microchip Technology Drawing C04-062B



## 8-Lead Plastic Small Outline (SN) – Narrow, 3.90 mm Body [SOIC]

**Note:** For the most current package drawings, please see the Microchip Packaging Specification located at <http://www.microchip.com/packaging>



Dimension Limits	Units	MILLMETERS		
		MIN	NOM	MAX
Number of Pins	N	8		
Pitch	e	1.27 BSC		
Overall Height	A	–	–	1.75
Molded Package Thickness	A2	1.25	–	–
Standoff §	A1	0.10	–	0.25
Overall Width	E	6.00 BSC		
Molded Package Width	E1	3.90 BSC		
Overall Length	D	4.90 BSC		
Chamfer (optional)	h	0.25	–	0.50
Foot Length	L	0.40	–	1.27
Footprint	L1	1.04 REF		
Foot Angle	$\phi$	0°	–	8°
Lead Thickness	c	0.17	–	0.25
Lead Width	b	0.31	–	0.51
Mold Draft Angle Top	$\alpha$	5°	–	15°
Mold Draft Angle Bottom	$\beta$	5°	–	15°

**Notes:**

- Pin 1 visual index feature may vary, but must be located within the hatched area.
- § Significant Characteristic.
- Dimensions D and E1 do not include mold flash or protrusions. Mold flash or protrusions shall not exceed 0.15 mm per side.
- Dimensioning and tolerancing per ASME Y14.5M.

BSC: Basic Dimension. Theoretically exact value shown without tolerances.

REF: Reference Dimension, usually without tolerance, for information purposes only.

Microchip Technology Drawing C04-057B

# MCP1727

---

NOTES:

## APPENDIX A: REVISION HISTORY

### Revision B (February 2007)

- Revised Notes on pages 8–13.
- Added junction temperature note.
- Figure 2-22: Revised label on Y-axis
- Figure 2-27 and Figure 2-28: Replaced figure and revised figure captions.
- Added disclaimers to package outline drawings.
- Updated package outline drawings.

### Revision A (July 2006)

- Original Release of this Document.

# MCP1727

---

NOTES:

## PRODUCT IDENTIFICATION SYSTEM

To order or obtain information, e.g., on pricing or delivery, refer to the factory or the listed sales office.

<u>PART NO.</u>	<u>XX</u>	<u>X</u>	<u>X</u>	<u>X/</u>	<u>XX</u>
Device	Output Voltage	Feature Code	Tolerance	Temp.	Package
Device:		MCP1727:	1.5A Low Dropout Regulator		
		MCP1727T:	1.5A Low Dropout Regulator Tape and Reel		
Output Voltage *:	08	=	0.8V "Standard"		
	12	=	1.2V "Standard"		
	18	=	1.8V "Standard"		
	25	=	2.5V "Standard"		
	30	=	3.0V "Standard"		
	33	=	3.3V "Standard"		
	50	=	5.0V "Standard"		
		*Contact factory for other output voltage options			
Extra Feature Code:	0	=	Fixed		
Tolerance:	2	=	2.0% (Standard)		
Temperature:	E	=	-40°C to +125°C		
Package Type:	MF	=	Plastic Dual Flat No Lead (DFN) (3x3x0.9 mm Body), 8-lead		
	SN	=	Plastic Small Outline (150 mil Body), 8-lead		

Examples:	
a)	MCP1727-0802E/MF: 0.8V Low Dropout Regulator, DFN8 pkg.
b)	MCP1727T-1202E/MF: Tape and Reel, 1.2V Low Dropout Regulator, DFN8 pkg.
c)	MCP1727-1802E/MF: 1.8V Low Dropout Voltage Regulator, DFN8 pkg.
d)	MCP1727T-2502E/MF: Tape and Reel, 2.5V Low Dropout Voltage Regulator, DFN8 pkg.
e)	MCP1727-3002E/MF: 3.0V Low Dropout Voltage Regulator, DFN8 pkg.
f)	MCP1727-3302E/MF: 3.3V Low Dropout Voltage Regulator, DFN8 pkg.
g)	MCP1727T-5002E/MF: Tape and Reel, 5.0V Low Dropout Voltage Regulator, DFN8 pkg.
h)	MCP1727T-0802E/SN: Tape and Reel, 0.8V Low Dropout Voltage Regulator, SOIC8 pkg.
i)	MCP1727-1202E/SN: 1.2V Low Dropout Voltage Regulator, SOIC8 pkg.
j)	MCP1727T-1802E/SN: Tape and Reel, 1.8V Low Dropout Voltage Regulator, SOIC8 pkg.
k)	MCP1727-2502E/SN: 2.5V Low Dropout Voltage Regulator, SOIC8 pkg.
l)	MCP1727-3002E/SN: 3.0V Low Dropout Voltage Regulator, SOIC8 pkg.
m)	MCP1727-3302E/SN: 3.3V Low Dropout Voltage Regulator, SOIC8 pkg.
n)	MCP1727T-5002E/SN: Tape and Reel, 5.0V Low Dropout Voltage Regulator, SOIC8 pkg.

# MCP1727

---

NOTES:

---

**Note the following details of the code protection feature on Microchip devices:**

- Microchip products meet the specification contained in their particular Microchip Data Sheet.
- Microchip believes that its family of products is one of the most secure families of its kind on the market today, when used in the intended manner and under normal conditions.
- There are dishonest and possibly illegal methods used to breach the code protection feature. All of these methods, to our knowledge, require using the Microchip products in a manner outside the operating specifications contained in Microchip's Data Sheets. Most likely, the person doing so is engaged in theft of intellectual property.
- Microchip is willing to work with the customer who is concerned about the integrity of their code.
- Neither Microchip nor any other semiconductor manufacturer can guarantee the security of their code. Code protection does not mean that we are guaranteeing the product as "unbreakable."

Code protection is constantly evolving. We at Microchip are committed to continuously improving the code protection features of our products. Attempts to break Microchip's code protection feature may be a violation of the Digital Millennium Copyright Act. If such acts allow unauthorized access to your software or other copyrighted work, you may have a right to sue for relief under that Act.

---

Information contained in this publication regarding device applications and the like is provided only for your convenience and may be superseded by updates. It is your responsibility to ensure that your application meets with your specifications. MICROCHIP MAKES NO REPRESENTATIONS OR WARRANTIES OF ANY KIND WHETHER EXPRESS OR IMPLIED, WRITTEN OR ORAL, STATUTORY OR OTHERWISE, RELATED TO THE INFORMATION, INCLUDING BUT NOT LIMITED TO ITS CONDITION, QUALITY, PERFORMANCE, MERCHANTABILITY OR FITNESS FOR PURPOSE. Microchip disclaims all liability arising from this information and its use. Use of Microchip devices in life support and/or safety applications is entirely at the buyer's risk, and the buyer agrees to defend, indemnify and hold harmless Microchip from any and all damages, claims, suits, or expenses resulting from such use. No licenses are conveyed, implicitly or otherwise, under any Microchip intellectual property rights.

**Trademarks**

The Microchip name and logo, the Microchip logo, Accuron, dsPIC, KEELOQ, KEELOQ logo, microID, MPLAB, PIC, PICmicro, PICSTART, PRO MATE, PowerSmart, rPIC, and SmartShunt are registered trademarks of Microchip Technology Incorporated in the U.S.A. and other countries.

AmpLab, FilterLab, Linear Active Thermistor, Migratable Memory, MXDEV, MXLAB, PS logo, SEEVAL, SmartSensor and The Embedded Control Solutions Company are registered trademarks of Microchip Technology Incorporated in the U.S.A.

Analog-for-the-Digital Age, Application Maestro, CodeGuard, dsPICDEM, dsPICDEM.net, dsPICworks, ECAN, ECONOMONITOR, FanSense, FlexROM, fuzzyLAB, In-Circuit Serial Programming, ICSP, ICEPIC, Mindi, MiWi, MPASM, MPLAB Certified logo, MPLIB, MPLINK, PICkit, PICDEM, PICDEM.net, PICLAB, PICtail, PowerCal, PowerInfo, PowerMate, PowerTool, REAL ICE, rLAB, rfPICDEM, Select Mode, Smart Serial, SmartTel, Total Endurance, UNI/O, WiperLock and ZENA are trademarks of Microchip Technology Incorporated in the U.S.A. and other countries.

SQTP is a service mark of Microchip Technology Incorporated in the U.S.A.

All other trademarks mentioned herein are property of their respective companies.

© 2007, Microchip Technology Incorporated, Printed in the U.S.A., All Rights Reserved.

 Printed on recycled paper.

*Microchip received ISO/TS-16949:2002 certification for its worldwide headquarters, design and wafer fabrication facilities in Chandler and Tempe, Arizona, Gresham, Oregon and Mountain View, California. The Company's quality system processes and procedures are for its PIC<sup>®</sup> MCUs and dsPIC<sup>®</sup> DSCs, KEELOQ<sup>®</sup> code hopping devices, Serial EEPROMs, microperipherals, nonvolatile memory and analog products. In addition, Microchip's quality system for the design and manufacture of development systems is ISO 9001:2000 certified.*

**QUALITY MANAGEMENT SYSTEM  
CERTIFIED BY DNV  
== ISO/TS 16949:2002 ==**



---

## WORLDWIDE SALES AND SERVICE

---

### AMERICAS

**Corporate Office**  
2355 West Chandler Blvd.  
Chandler, AZ 85224-6199  
Tel: 480-792-7200  
Fax: 480-792-7277  
Technical Support:  
<http://support.microchip.com>  
Web Address:  
[www.microchip.com](http://www.microchip.com)

**Atlanta**  
Duluth, GA  
Tel: 678-957-9614  
Fax: 678-957-1455

**Boston**  
Westborough, MA  
Tel: 774-760-0087  
Fax: 774-760-0088

**Chicago**  
Itasca, IL  
Tel: 630-285-0071  
Fax: 630-285-0075

**Dallas**  
Addison, TX  
Tel: 972-818-7423  
Fax: 972-818-2924

**Detroit**  
Farmington Hills, MI  
Tel: 248-538-2250  
Fax: 248-538-2260

**Kokomo**  
Kokomo, IN  
Tel: 765-864-8360  
Fax: 765-864-8387

**Los Angeles**  
Mission Viejo, CA  
Tel: 949-462-9523  
Fax: 949-462-9608

**Santa Clara**  
Santa Clara, CA  
Tel: 408-961-6444  
Fax: 408-961-6445

**Toronto**  
Mississauga, Ontario,  
Canada  
Tel: 905-673-0699  
Fax: 905-673-6509

### ASIA/PACIFIC

**Asia Pacific Office**  
Suites 3707-14, 37th Floor  
Tower 6, The Gateway  
Harbour City, Kowloon  
Hong Kong  
Tel: 852-2401-1200  
Fax: 852-2401-3431

**Australia - Sydney**  
Tel: 61-2-9868-6733  
Fax: 61-2-9868-6755

**China - Beijing**  
Tel: 86-10-8528-2100  
Fax: 86-10-8528-2104

**China - Chengdu**  
Tel: 86-28-8665-5511  
Fax: 86-28-8665-7889

**China - Fuzhou**  
Tel: 86-591-8750-3506  
Fax: 86-591-8750-3521

**China - Hong Kong SAR**  
Tel: 852-2401-1200  
Fax: 852-2401-3431

**China - Qingdao**  
Tel: 86-532-8502-7355  
Fax: 86-532-8502-7205

**China - Shanghai**  
Tel: 86-21-5407-5533  
Fax: 86-21-5407-5066

**China - Shenyang**  
Tel: 86-24-2334-2829  
Fax: 86-24-2334-2393

**China - Shenzhen**  
Tel: 86-755-8203-2660  
Fax: 86-755-8203-1760

**China - Shunde**  
Tel: 86-757-2839-5507  
Fax: 86-757-2839-5571

**China - Wuhan**  
Tel: 86-27-5980-5300  
Fax: 86-27-5980-5118

**China - Xian**  
Tel: 86-29-8833-7250  
Fax: 86-29-8833-7256

### ASIA/PACIFIC

**India - Bangalore**  
Tel: 91-80-4182-8400  
Fax: 91-80-4182-8422

**India - New Delhi**  
Tel: 91-11-4160-8631  
Fax: 91-11-4160-8632

**India - Pune**  
Tel: 91-20-2566-1512  
Fax: 91-20-2566-1513

**Japan - Yokohama**  
Tel: 81-45-471-6166  
Fax: 81-45-471-6122

**Korea - Gumi**  
Tel: 82-54-473-4301  
Fax: 82-54-473-4302

**Korea - Seoul**  
Tel: 82-2-554-7200  
Fax: 82-2-558-5932 or  
82-2-558-5934

**Malaysia - Penang**  
Tel: 60-4-646-8870  
Fax: 60-4-646-5086

**Philippines - Manila**  
Tel: 63-2-634-9065  
Fax: 63-2-634-9069

**Singapore**  
Tel: 65-6334-8870  
Fax: 65-6334-8850

**Taiwan - Hsin Chu**  
Tel: 886-3-572-9526  
Fax: 886-3-572-6459

**Taiwan - Kaohsiung**  
Tel: 886-7-536-4818  
Fax: 886-7-536-4803

**Taiwan - Taipei**  
Tel: 886-2-2500-6610  
Fax: 886-2-2508-0102

**Thailand - Bangkok**  
Tel: 66-2-694-1351  
Fax: 66-2-694-1350

### EUROPE

**Austria - Wels**  
Tel: 43-7242-2244-39  
Fax: 43-7242-2244-393

**Denmark - Copenhagen**  
Tel: 45-4450-2828  
Fax: 45-4485-2829

**France - Paris**  
Tel: 33-1-69-53-63-20  
Fax: 33-1-69-30-90-79

**Germany - Munich**  
Tel: 49-89-627-144-0  
Fax: 49-89-627-144-44

**Italy - Milan**  
Tel: 39-0331-742611  
Fax: 39-0331-466781

**Netherlands - Drunen**  
Tel: 31-416-690399  
Fax: 31-416-690340

**Spain - Madrid**  
Tel: 34-91-708-08-90  
Fax: 34-91-708-08-91

**UK - Wokingham**  
Tel: 44-118-921-5869  
Fax: 44-118-921-5820





Компания «ЭлектроПласт» предлагает заключение долгосрочных отношений при поставках импортных электронных компонентов на взаимовыгодных условиях!

Наши преимущества:

- Оперативные поставки широкого спектра электронных компонентов отечественного и импортного производства напрямую от производителей и с крупнейших мировых складов;
- Поставка более 17-ти миллионов наименований электронных компонентов;
- Поставка сложных, дефицитных, либо снятых с производства позиций;
- Оперативные сроки поставки под заказ (от 5 рабочих дней);
- Экспресс доставка в любую точку России;
- Техническая поддержка проекта, помощь в подборе аналогов, поставка прототипов;
- Система менеджмента качества сертифицирована по Международному стандарту ISO 9001;
- Лицензия ФСБ на осуществление работ с использованием сведений, составляющих государственную тайну;
- Поставка специализированных компонентов (Xilinx, Altera, Analog Devices, Intersil, Interpoint, Microsemi, Aeroflex, Peregrine, Syfer, Eurofarad, Texas Instrument, Miteq, Cobham, E2V, MA-COM, Hittite, Mini-Circuits, General Dynamics и др.);

Помимо этого, одним из направлений компании «ЭлектроПласт» является направление «Источники питания». Мы предлагаем Вам помощь Конструкторского отдела:

- Подбор оптимального решения, техническое обоснование при выборе компонента;
- Подбор аналогов;
- Консультации по применению компонента;
- Поставка образцов и прототипов;
- Техническая поддержка проекта;
- Защита от снятия компонента с производства.



#### Как с нами связаться

**Телефон:** 8 (812) 309 58 32 (многоканальный)

**Факс:** 8 (812) 320-02-42

**Электронная почта:** [org@eplast1.ru](mailto:org@eplast1.ru)

**Адрес:** 198099, г. Санкт-Петербург, ул. Калинина, дом 2, корпус 4, литера А.