

Nanopower Precision Shunt Voltage Reference

FEATURES

- Initial Voltage Accuracy: 0.05%
- Low Operating Current: 800nA
- Low Drift: 10ppm/°C Max
- Less Than 1Ω Dynamic Impedance
- Available in 1.25V, 2.5V, 4.096V and 5V SO-8 Packages

APPLICATIONS

- Portable Meters
- Precision Regulators
- A/D and D/A Converters
- Calibrators

DESCRIPTION

The LT[®]1389 is a nanopower, precision shunt voltage reference. The bandgap reference uses trimmed precision thin-film resistors and improved curvature correction techniques to achieve 0.05% initial voltage accuracy with guaranteed 10ppm/°C maximum temperature drift. Voltage regulation is maintained to an ultralow 800nA operating current. Advances in design, processing and packaging achieve low temperature cycling hysteresis.

The LT1389 does not require an output compensation capacitor, but is stable with capacitive loads. Low dynamic impedance makes the LT1389 reference easy to use from unregulated supplies.

The LT1389 reference can be used as a high performance upgrade to the LM185/LM385, LT1004, LT1034 and LT1634 where lowest power and guaranteed temperature drift are required.

LT, LTC and LT are registered trademarks of Linear Technology Corporation.

TYPICAL APPLICATION

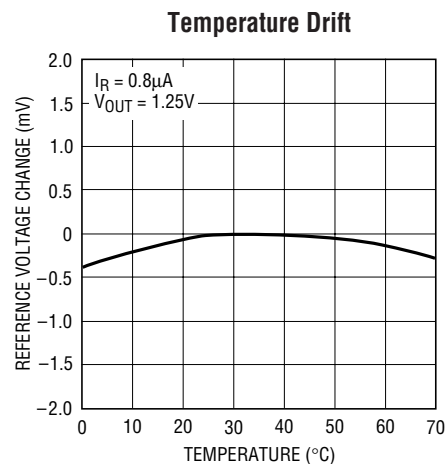
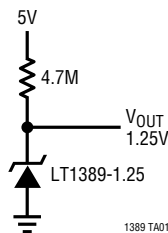

ABSOLUTE MAXIMUM RATINGS

(Note 1)

Operating Current	
1.25V	20mA
2.5V	20mA
4.096V	10mA
5V	10mA
Forward Current	20mA
Operating Temperature Range	0°C to 70°C
Storage Temperature Range (Note 2) ...	-65°C to 150°C
Lead Temperature (Soldering, 10 sec).....	300°C

PACKAGE/ORDER INFORMATION

	ORDER PART NUMBER	
	LT1389ACS8-1.25 LT1389BCS8-1.25 LT1389BCS8-2.5 LT1389BCS8-4.096 LT1389BCS8-5	
	S8 PART MARKING	
	389A12	1389B4
	389B12	1389B5
	389B25	

*Connected internally. Do Not Connect external circuitry to these pins. Consult factory for Industrial and Military grade parts.

AVAILABLE OPTIONS

TEMPERATURE	OUTPUT VOLTAGE	ACCURACY (%)	TEMPERATURE COEFFICIENT (ppm/°C)	PART TYPE	PART MARKING
0°C to 70°C	1.250	0.05	10	LT1389ACS8-1.25	389A12
	1.250	0.05	20	LT1389BCS8-1.25	389B12
	2.500	0.05	20	LT1389BCS8-2.5	389B25
	4.096	0.075	50	LT1389BCS8-4.096	1389B4
	5.000	0.075	50	LT1389BCS8-5	1389B5

1.25V ELECTRICAL CHARACTERISTICS

The ● denotes specifications which apply over the full operating temperature range, otherwise specifications are at $T_A = 25^\circ\text{C}$. (Note 3)

PARAMETER	CONDITIONS	MIN	TYP	MAX	UNITS
Reverse Breakdown Voltage	LT1389ACS8/LT1389BCS8 ($I_R = 0.8\mu\text{A}$)	1.24937 -0.05	1.250	1.25062 0.05	V %
	LT1389ACS8 ($I_R = 0.8\mu\text{A}$)	● 1.24849 -0.12	1.250	1.25149 0.12	V %
	LT1389BCS8 ($I_R = 0.8\mu\text{A}$)	● 1.24762 -0.19	1.250	1.25237 0.19	V %
Reverse Breakdown Change with Current (Note 4)	$0.8\mu\text{A} \leq I_R \leq 200\mu\text{A}$	●	0.20 0.20	0.4 1.0	mV mV
	$200\mu\text{A} \leq I_R \leq 2\text{mA}$	●	0.3 0.3	1.0 2.0	mV mV
Minimum Operating Current		●		0.6	μA
Temperature Coefficient	LT1389ACS8 ($I_R = 0.8\mu\text{A}$)	●	4	10	ppm/°C
	LT1389BCS8 ($I_R = 0.8\mu\text{A}$)	●	4	20	ppm/°C
Reverse Dynamic Impedance (Note 5)	$0.8\mu\text{A} \leq I_R \leq 2\text{mA}$	●	0.25	0.7	Ω
			0.25	1.5	Ω
Low Frequency Noise (Note 6)	$I_R = 0.8\mu\text{A}, 0.1\text{Hz} \leq f \leq 10\text{Hz}$		25		$\mu\text{V}_{\text{P-P}}$

2.5V ELECTRICAL CHARACTERISTICS

The ● denotes specifications which apply over the full operating temperature range, otherwise specifications are at $T_A = 25^\circ\text{C}$. (Note 3)

PARAMETER	CONDITIONS	MIN	TYP	MAX	UNITS
Reverse Breakdown Voltage	LT1389BCS8 ($I_R = 0.9\mu\text{A}$)	2.49875 -0.05	2.500	2.50125 0.05	V %
	LT1389BCS8 ($I_R = 0.9\mu\text{A}$)	● 2.49525 -0.19	2.500	2.50475 0.19	V %
Reverse Breakdown Change with Current (Note 4)	$0.9\mu\text{A} \leq I_R \leq 200\mu\text{A}$	●	0.2 0.2	0.5 1.5	mV mV
	$200\mu\text{A} \leq I_R \leq 2\text{mA}$	●	0.3 0.3	1.0 2.5	mV mV
Minimum Operating Current		●		0.7	μA
Temperature Coefficient	$I_R = 0.9\mu\text{A}$	●	8	20	ppm/ $^\circ\text{C}$
Reverse Dynamic Impedance (Note 5)	$0.9\mu\text{A} \leq I_R \leq 2\text{mA}$	●	0.25	0.75	Ω
		●	0.25	2	Ω
Low Frequency Noise (Note 6)	$I_R = 0.9\mu\text{A}, 0.1\text{Hz} \leq f \leq 10\text{Hz}$		50		μV_{P-P}

4.096V ELECTRICAL CHARACTERISTICS

The ● denotes specifications which apply over the full operating temperature range, otherwise specifications are at $T_A = 25^\circ\text{C}$. (Note 3)

PARAMETER	CONDITIONS	MIN	TYP	MAX	UNITS
Reverse Breakdown Voltage	LT1389BCS8 ($I_R = 1.5\mu\text{A}$)	4.09293 -0.075	4.096	4.09907 0.075	V %
	LT1389BCS8 ($I_R = 1.5\mu\text{A}$)	● 4.0788 -0.42	4.096	4.1132 0.42	V %
Reverse Breakdown Change with Current (Note 4)	$1.5\mu\text{A} \leq I_R \leq 200\mu\text{A}$	●	0.2 0.2	1.5 3	mV mV
	$200\mu\text{A} \leq I_R \leq 2\text{mA}$	●	0.3 0.3	4 6	mV mV
Minimum Operating Current		●		1	μA
Temperature Coefficient	$I_R = 1.5\mu\text{A}$	●	12	50	ppm/ $^\circ\text{C}$
Reverse Dynamic Impedance (Note 5)	$1.5\mu\text{A} \leq I_R \leq 2\text{mA}$	●	0.75	2	Ω
		●	0.75	3	Ω
Low Frequency Noise (Note 6)	$I_R = 1.5\mu\text{A}, 0.1\text{Hz} \leq f \leq 10\text{Hz}$		80		μV_{P-P}

5V ELECTRICAL CHARACTERISTICS The ● denotes specifications which apply over the full operating temperature range, otherwise specifications are at T_A = 25°C. (Note 3)

PARAMETER	CONDITIONS		MIN	TYP	MAX	UNITS
Reverse Breakdown Voltage	LT1389BCS8 (I _R = 1.5μA)		4.99625 -0.075	5.000	5.00375 0.075	V %
	LT1389BCS8 (I _R = 1.5μA)	●	4.979 -0.42	5.000	5.021 0.42	V %
Reverse Breakdown Change with Current (Note 4)	1.5μA ≤ I _R ≤ 200μA	●		0.2 0.2	1.5 3	mV mV
	200μA ≤ I _R ≤ 2mA	●		0.3 0.3	4 6	mV mV
Minimum Operating Current		●			1	μA
Temperature Coefficient	I _R = 1.5μA	●		12	50	ppm/°C
Reverse Dynamic Impedance (Note 5)	1.5μA ≤ I _R ≤ 2mA			0.75	2	Ω
		●		0.75	3	Ω
Low Frequency Noise (Note 6)	I _R = 1.5μA, 0.1Hz ≤ f ≤ 10Hz			100		μV _{P-P}

Note 1: Absolute Maximum Ratings are those values beyond which the life of a device may be impaired.

Note 2: If the part is stored outside of the specific operating temperature range, the output may shift due to hysteresis.

Note 3: ESD (Electrostatic Discharge) sensitive device. Use proper ESD handling precautions.

Note 4: Output requires 0.1μF for operating current greater than 1mA.

Note 5: This parameter is guaranteed by “reverse breakdown change with current” test.

Note 6: Peak-to-peak noise is measured with a single highpass filter at 0.1Hz and 2-pole lowpass filter at 10Hz.

1.25V TYPICAL PERFORMANCE CHARACTERISTICS

Reverse Characteristics

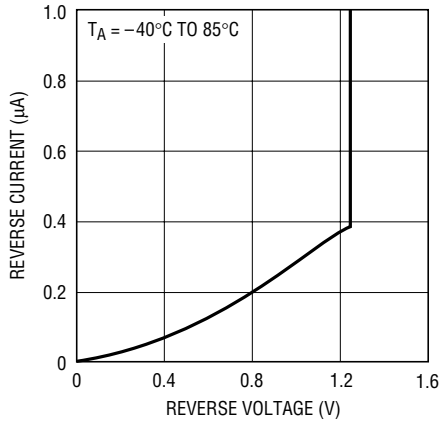

1389-1.25 G01

Temperature Drift

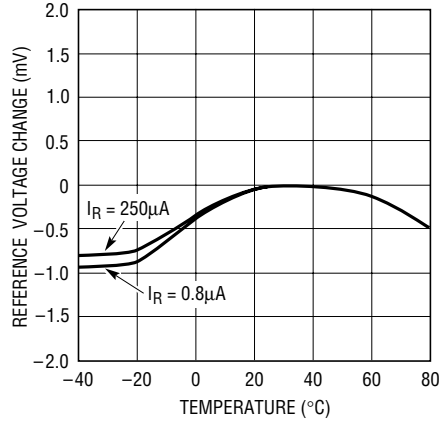

1389-1.25 G02

Reverse Voltage Change vs Current

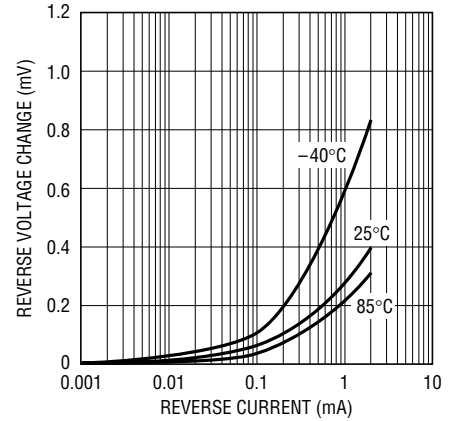

1389-1.25 G03

Reverse Dynamic Impedance

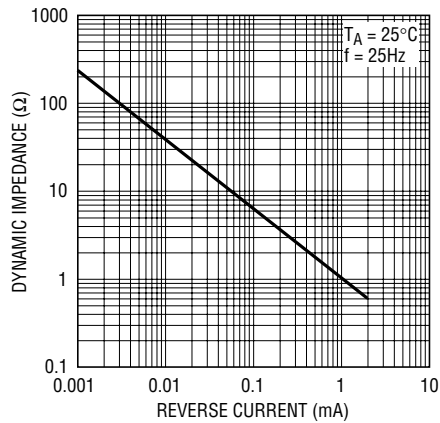

1389-1.25 G04

Dynamic Impedance vs Frequency

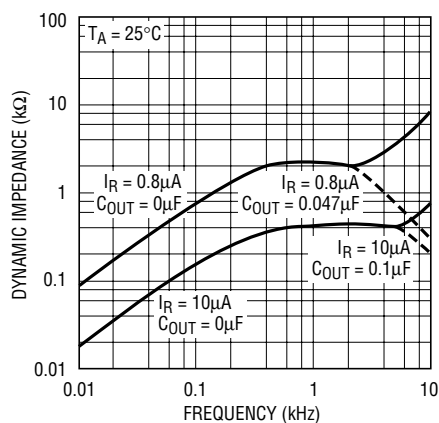

1389-1.25 G05

Forward Characteristics

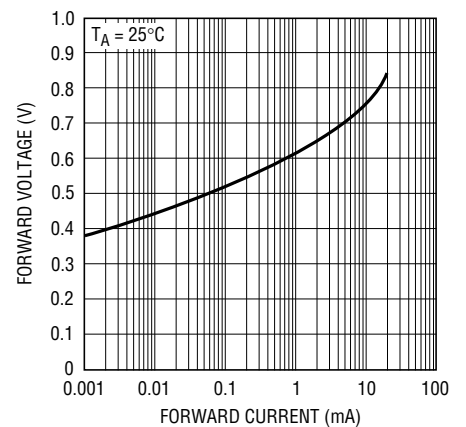

1389-1.25 G06

0.1Hz to 10Hz Noise

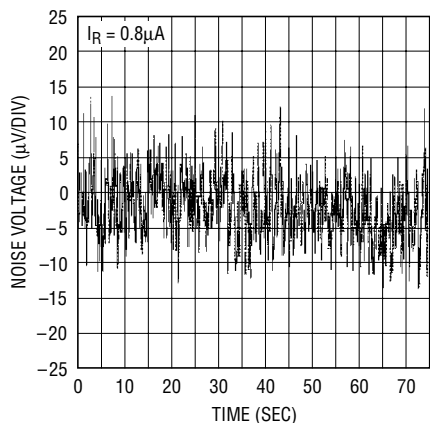

1389-1.25 G07

Response Time

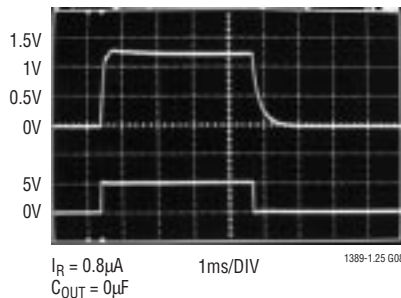

1389-1.25 G08

Response Time

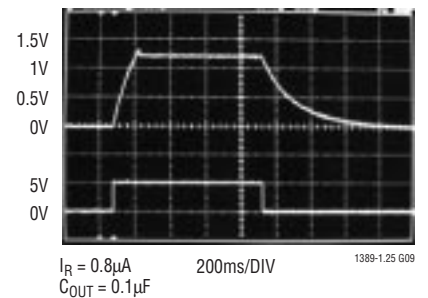

1389-1.25 G09

2.5V TYPICAL PERFORMANCE CHARACTERISTICS

Reverse Characteristics

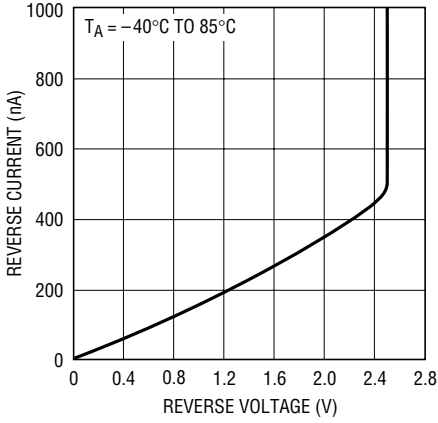

1389-2.5 G01

Temperature Drift

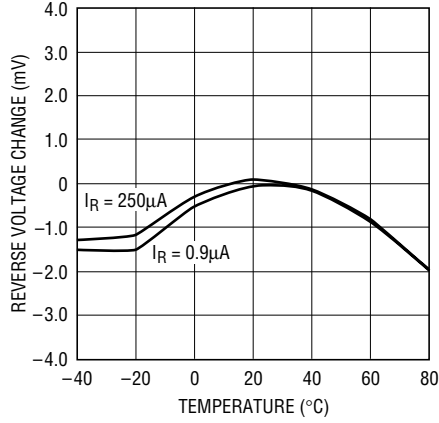

1389-2.5 TA02

Reverse Voltage Change vs Current

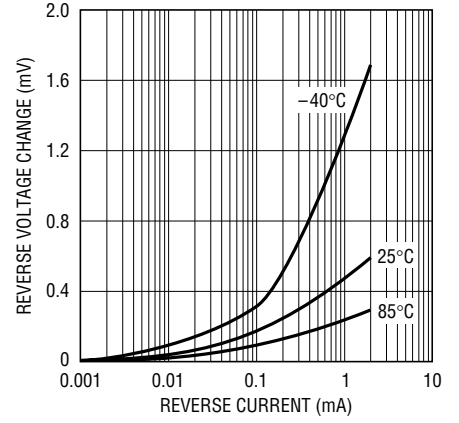

1389-2.5 G03

Reverse Dynamic Impedance

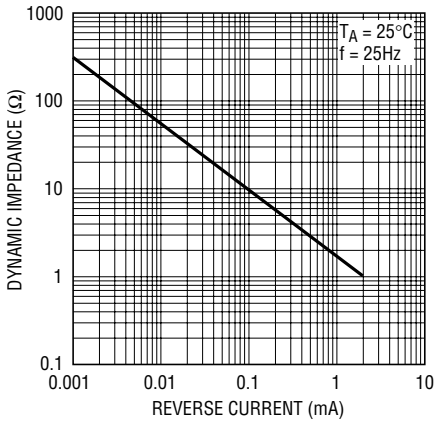

1389-2.5 G04

Dynamic Impedance vs Frequency

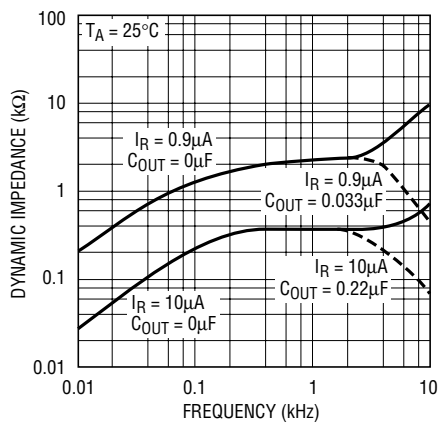

1389-2.5 G05

Forward Characteristics

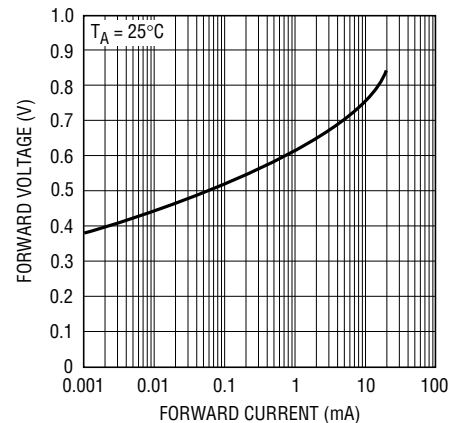

1389-2.5 G06

0.1Hz to 10Hz Noise

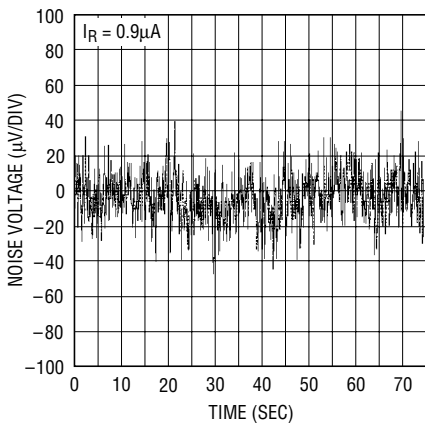

1389-2.5 G07

Response Time

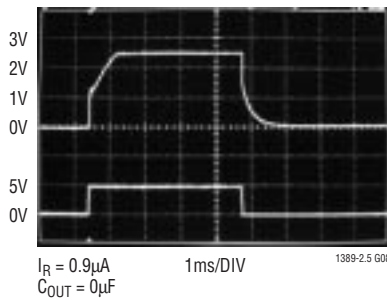

1389-2.5 G08

Response Time

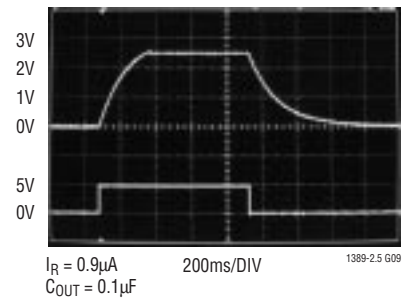

1389-2.5 G09

4.096V TYPICAL PERFORMANCE CHARACTERISTICS

Reverse Characteristics

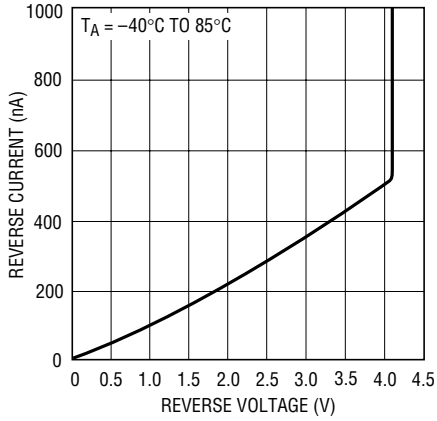

1389-4 G01

Temperature Drift

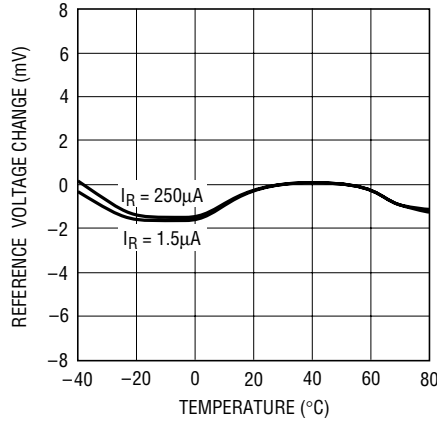

1389-4 G02

Reverse Voltage Change vs Current

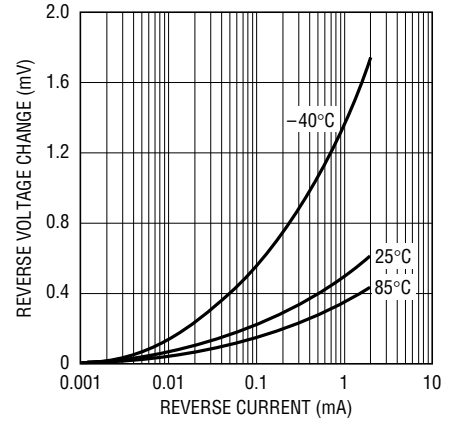

1389-4 G03

Reverse Dynamic Impedance

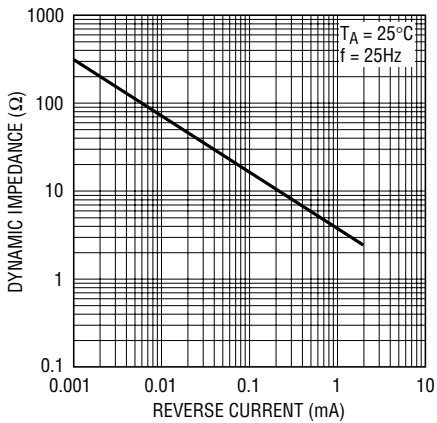

1389-4 G04

Dynamic Impedance vs Frequency

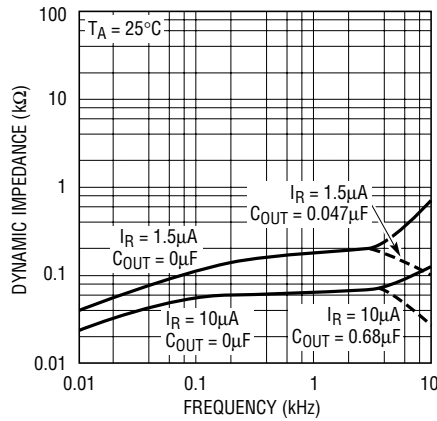

1389-4 G05

Forward Characteristics

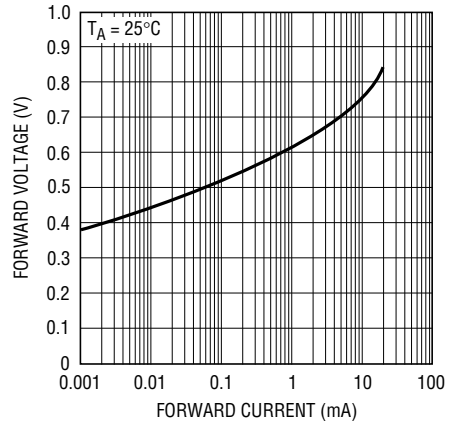

1389-4 G06

Response Time

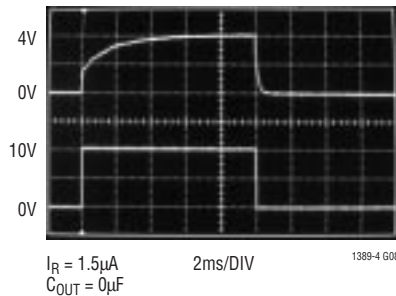

1389-4 G08

Response Time

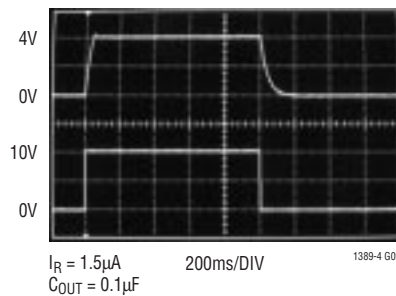

1389-4 G09

5V TYPICAL PERFORMANCE CHARACTERISTICS

Reverse Characteristics

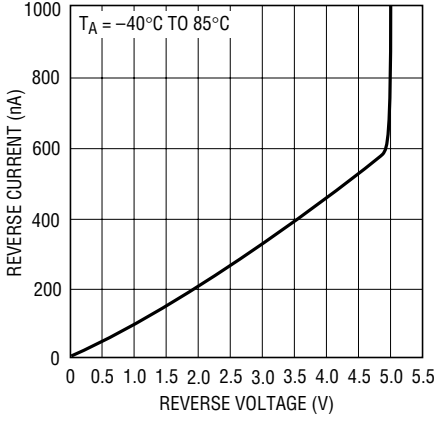

1389-4 G01

Temperature Drift

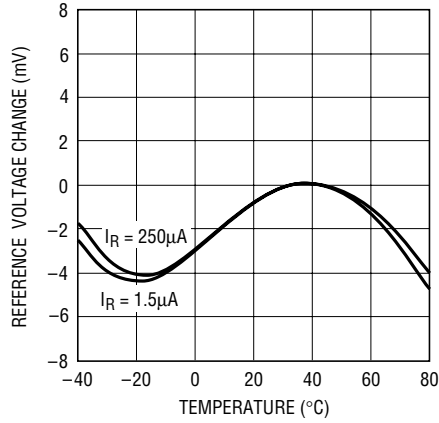

1389-5 G02

Reverse Voltage Change vs Current

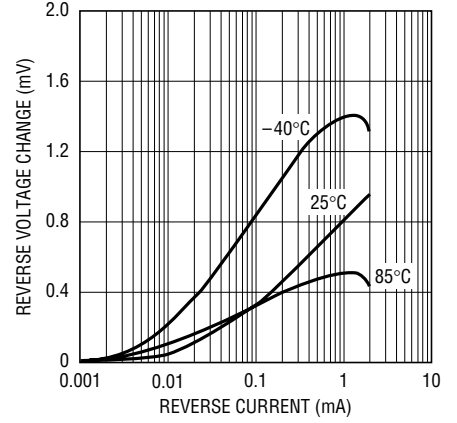

1389-4 G03

Reverse Dynamic Impedance

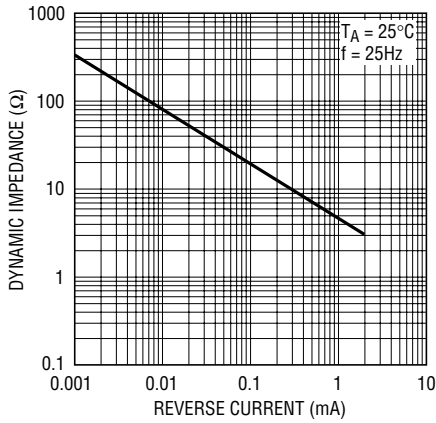

1389-5 G04

Dynamic Impedance vs Frequency

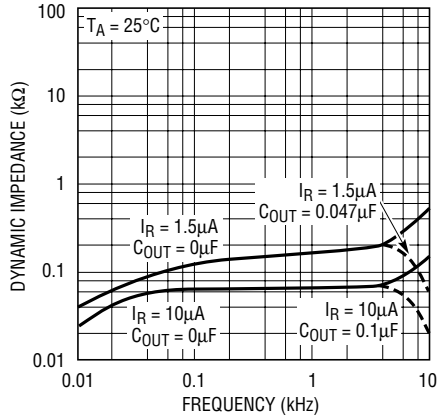

1389-4 G05

Forward Characteristics

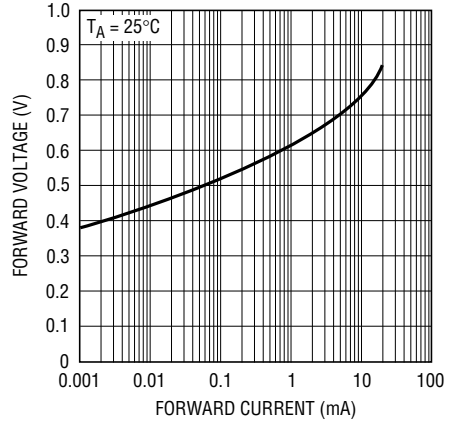

1389-5 G06

Response Time

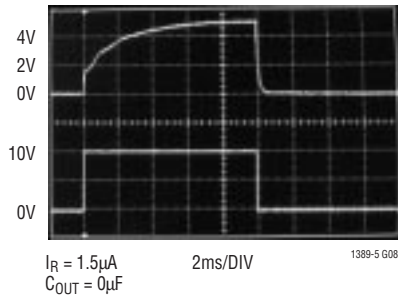

1389-5 G08

Response Time

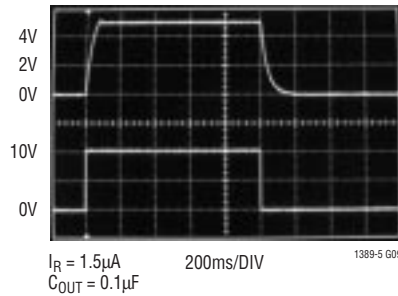

1389-5 G09

APPLICATIONS INFORMATION

The reverse characteristics of the LT1389 resembles a simple resistor Zener diode parallel connection. This well behaved characteristic is important to the proper operation of circuits like Figure 1. The adjustable output voltage reference depends upon positive feedback from the LT1495's output to start-up and regulate the bias current for the LT1389. The LT1389 has no negative resistance regions that can interfere with the proper start-up of the buffered reference.

Board leakage is a concern for a nanopower precision shunt voltage reference. The LT1389 requires attention to detail in board layout in order to maximize its performance. 1.5GΩ of leakage between a DNC pin and a 5V supply will conduct 2.5nA which induces a 0.2% error in V_{OUT}. Board leakage can be minimized by encircling the DNC pins with a guard ring operated at a potential of V_{OUT}. By tying the guard ring to V_{OUT} as shown in Figure 2, leakage paths are eliminated.

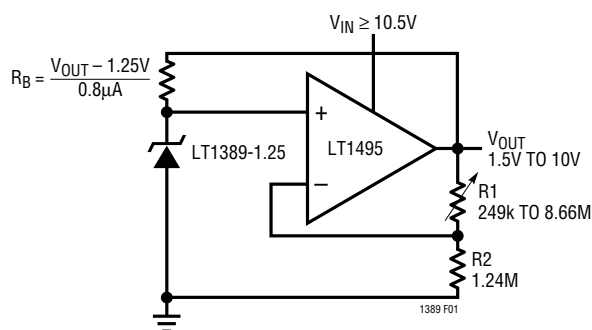

Figure 1. Adjustable Output Voltage Reference

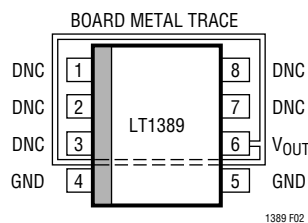
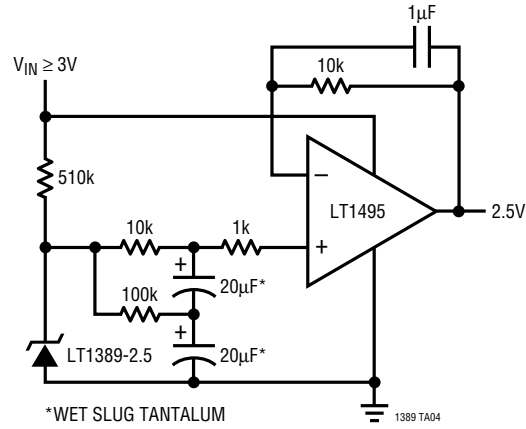

Figure 2. Guard Ring to Reduce Board Leakage

TYPICAL APPLICATIONS

2.5V Output, Low Noise Reference



Micropower Voltage and Current Reference

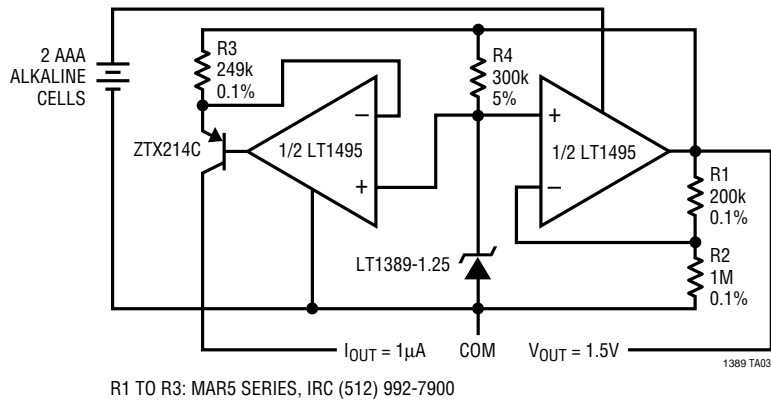

PACKAGE DESCRIPTION

Dimensions in inches (millimeters) unless otherwise noted.

S8 Package
8-Lead Plastic Small Outline (Narrow 0.150)
 (LTC DWG # 05-08-1610)

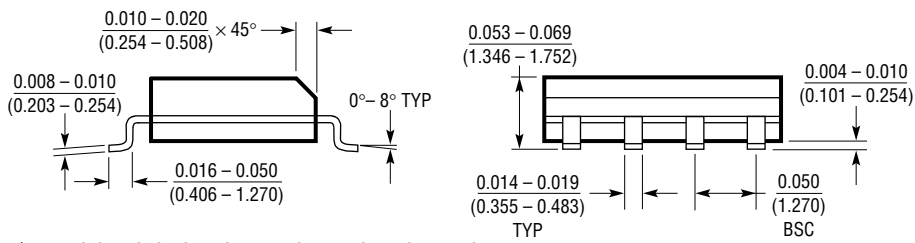
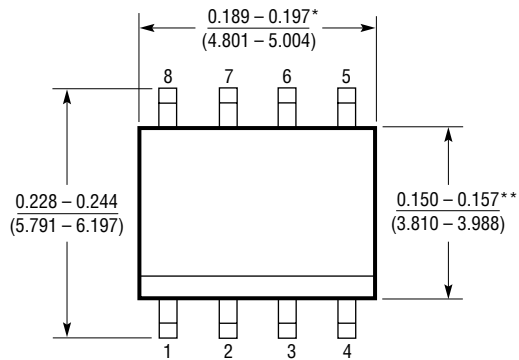

*DIMENSION DOES NOT INCLUDE MOLD FLASH. MOLD FLASH SHALL NOT EXCEED 0.006" (0.152mm) PER SIDE
 **DIMENSION DOES NOT INCLUDE INTERLEAD FLASH. INTERLEAD FLASH SHALL NOT EXCEED 0.010" (0.254mm) PER SIDE

S08 1298

TYPICAL APPLICATIONS

Single Cell Li-Ion Battery Supervisory Circuit, $I_Q = 10\mu A$

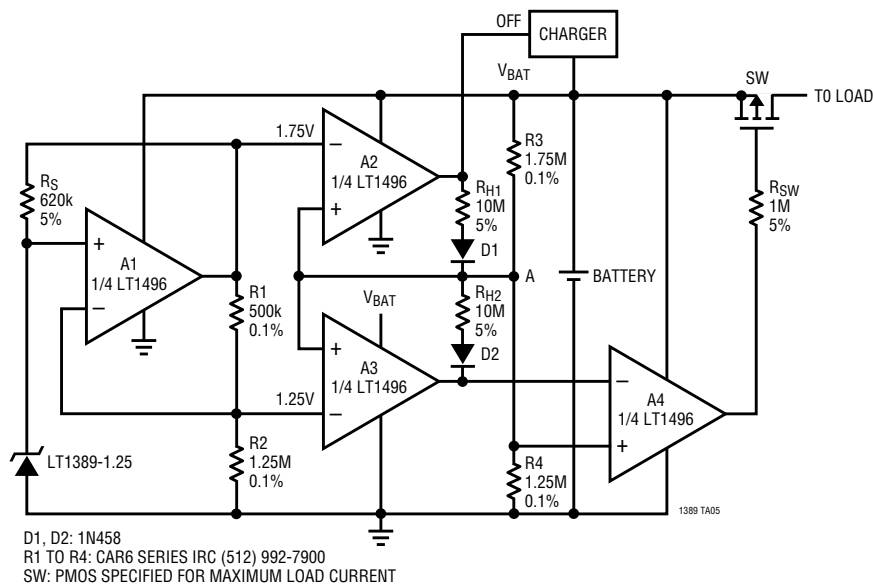

Precision Undervoltage Lockout Circuit

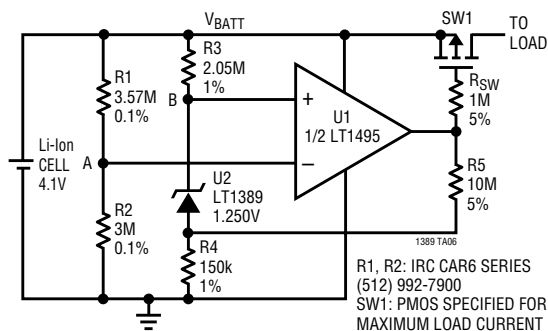

RELATED PARTS

PART NUMBER	DESCRIPTION	COMMENTS
LTC [®] 1440	Micropower Comparator with Reference	3.7 μA Max Supply Current, 1% 1.182V Reference, MSOP, PDIP and SO-8 Packages
LT1460	Micropower Series Reference	0.075% Max, 10ppm/ $^{\circ}C$ Max Drift, 2.5V, 5V and 10V Versions, MSOP, PDIP, SO-8, SOT-23 and TO-92 Packages
LT1461	Micropower Precision LDO Series Reference	3ppm/ $^{\circ}C$ Max Drift, 0 $^{\circ}C$ to 70 $^{\circ}C$, -40 $^{\circ}C$ to 85 $^{\circ}C$, -40 $^{\circ}C$ to 125 $^{\circ}C$ Options in SO-8
LT1495	1.5 μA Precision Rail-to-Rail Dual Op Amp	1.5 μA Max Supply Current, 100pA Max I_{OS}
LTC1540	Nanopower Comparator with Reference	600nA Max Supply Current, 2% 1.182V Reference, MSOP and SO-8 Packages
LT1634	Micropower Precision Shunt Voltage Reference	0.05% Max, 10ppm/ $^{\circ}C$ Max Drift, 1.25V, 2.5V, 4.096V, 5V, 10 μA Maximum Supply Current
LTC1798	6 μA Low Dropout Series Reference	Available in Adjustable, 2.5V, 3V, 4.096V and 5V



Компания «ЭлектроПласт» предлагает заключение долгосрочных отношений при поставках импортных электронных компонентов на взаимовыгодных условиях!

Наши преимущества:

- Оперативные поставки широкого спектра электронных компонентов отечественного и импортного производства напрямую от производителей и с крупнейших мировых складов;
- Поставка более 17-ти миллионов наименований электронных компонентов;
- Поставка сложных, дефицитных, либо снятых с производства позиций;
- Оперативные сроки поставки под заказ (от 5 рабочих дней);
- Экспресс доставка в любую точку России;
- Техническая поддержка проекта, помощь в подборе аналогов, поставка прототипов;
- Система менеджмента качества сертифицирована по Международному стандарту ISO 9001;
- Лицензия ФСБ на осуществление работ с использованием сведений, составляющих государственную тайну;
- Поставка специализированных компонентов (Xilinx, Altera, Analog Devices, Intersil, Interpoint, Microsemi, Aeroflex, Peregrine, Syfer, Eurofarad, Texas Instrument, Miteq, Cobham, E2V, MA-COM, Hittite, Mini-Circuits, General Dynamics и др.);

Помимо этого, одним из направлений компании «ЭлектроПласт» является направление «Источники питания». Мы предлагаем Вам помощь Конструкторского отдела:

- Подбор оптимального решения, техническое обоснование при выборе компонента;
- Подбор аналогов;
- Консультации по применению компонента;
- Поставка образцов и прототипов;
- Техническая поддержка проекта;
- Защита от снятия компонента с производства.



Как с нами связаться

Телефон: 8 (812) 309 58 32 (многоканальный)

Факс: 8 (812) 320-02-42

Электронная почта: org@eplast1.ru

Адрес: 198099, г. Санкт-Петербург, ул. Калинина, дом 2, корпус 4, литера А.