



FEATURES

- UL 60950 recognized
- RoHS compliant
- Efficiency from 80%
- Power density 1.31W/cm³
- Wide temperature performance at full 2 Watt load, -40°C to 85°C
- UL 94V-0 package material
- No heatsink required
- Industry standard pinout
- 3kVDC isolation (1 minute)
- 5V, 12V, 15V & 24V inputs
- 5V, 9V, 12V, & 15V output
- Fully encapsulated with toroidal magnetics
- No electrolytic or tantalum capacitors

PRODUCT OVERVIEW

The NMK series of industrial temperature range DC/DC converters, available in industry standard SIP packaging offers a power upgrade path from the 1W NMV series. The un-regulated NMK series has superior output voltage set point accuracy in conjunction with excellent load regulation for this converter type.

Unbalanced loading capabilities on dual output variants, all of the rated output power may be drawn from a single output³.



SELECTION GUIDE

Order Code ³	Nominal Input Voltage	Output Voltage	Output Current	Input Current at Rated Load	Load Regulation (Typ)	Load Regulation (Max)	Ripple & Noise (Typ) ¹	Ripple & Noise (Max) ¹	Efficiency (Min.)	Efficiency (Typ.)	Isolation Capacitance	MTTF ²
	V	V	mA	mA	%	%	mVp-p	mVp-p	%	%	pF	kHrs
NMK0505SAC	5	5	400	470	5.7	7.3	18	20	80	83	28	3998
NMK0509SAC	5	9	222	455	4.2	5.9	20	25	83	86	36	3718
NMK0512SAC	5	12	167	450	3.8	5.1	18	20	83	87	36	3328
NMK0515SAC	5	15	133	450	3.4	4.5	17	20	84	87	34	2855
NMK1205SAC	12	5	400	200	4.2	4.9	25	30	80	83	33	3532
NMK1209SAC	12	9	222	190	2.6	3.1	19	20	83	87	53	2417
NMK1212SAC	12	12	167	190	2.4	2.9	17	23	85	88	62	2246
NMK1215SAC	12	15	133	185	2.0	2.4	14	16	84	89	56	2020
NMK1505SAC	15	5	400	158	4.3	5.5	34	55	81	84	37	TBD
NMK1509SAC	15	9	222	153	3	4	21	40	83	86	51	TBD
NMK1512SAC	15	12	167	150	2.5	3.5	20	40	84	87	63	TBD
NMK1515SAC	15	15	133	149	2.4	3.5	20	40	85	88	72	TBD
NMK2405SAC	24	5	400	99	4.2	5.5	42	70	80	84	41	TBD
NMK2409SAC	24	9	222	95	2.7	3.5	30	55	83	87	59	TBD
NMK2412SAC	24	12	167	94	2.1	3	29	55	84	88	77	TBD
NMK2415SAC	24	15	133	93	2.2	3	34	70	85	88	85	TBD
NMK0505SC	5	±5	±200	470	5	6.2	24	40	81	83	28	2324
NMK0509SC	5	±9	±111	455	3.9	5.3	18	30	83	86	33	2158
NMK0512SC	5	±12	±83	450	3.7	4.8	14	20	84	87	35	1931
NMK0515SC	5	±15	±67	450	3.5	5.2	12	20	84	87	31	1655
NMK1205SC	12	±5	±200	200	3.4	3.9	21	30	80	84	35	1952
NMK1209SC	12	±9	±111	190	2.4	2.8	16	20	83	87	50	2021
NMK1212SC	12	±12	±83	190	2.2	2.7	13	20	84	87	53	1821
NMK1215SC	12	±15	±67	190	1.9	2.4	13	20	83	87	57	1574
NMK1505SC	15	±5	±200	156	3.7	5	27	50	81	84	43	TBD
NMK1509SC	15	±9	±111	153	2.4	3.5	19	35	82	86	47	TBD
NMK1512SC	15	±12	±83	151	2.2	3	18	35	84	88	65	TBD
NMK1515SC	15	±15	±67	150	2.0	3	14	35	85	88	74	TBD
NMK2405SC	24	±5	±200	96	3.4	5	30	50	81	84	43	TBD
NMK2409SC	24	±9	±111	94	2.3	3.5	26	45	84	87	65	TBD
NMK2412SC	24	±12	±83	93	1.9	3	24	45	85	89	82	TBD
NMK2415SC	24	±15	±67	93	1.7	3	17	35	85	89	86	TBD

INPUT CHARACTERISTICS

Parameter	Conditions	Min.	Typ.	Max.	Units
Voltage range	Continuous operation, 5V input types	4.5	5	5.5	V
	Continuous operation, 12V input types	10.8	12	13.2	
	Continuous operation, 15V input types	13.5	15	16.5	
	Continuous operation, 24V input types	21.6	24	26.4	
Reflected ripple current	NMK2405SAC, NMK2409SAC, NMK2405SC, NMK2409SC		14	25	mA p-p
	All other variants		7.5	15	

1. See Ripple & Noise characterisation method.

2. Calculated using MIL-HDBK-217F FN2 with nominal input voltage at full load.

3. See application notes on page 3.

All specifications typical at T_a=25°C, nominal input voltage and rated output current unless otherwise specified.

OUTPUT CHARACTERISTICS

Parameter	Conditions	Min.	Typ.	Max.	Units
Rated Power	T _A =-40°C to 85°C			2	W
Voltage Set Point Accuracy	See tolerance envelope				
Line regulation	High V _{IN} to low V _{IN}		1.05	1.2	%/%

ABSOLUTE MAXIMUM RATINGS

Lead temperature 1.5mm from case for 10 seconds	260°C
Input voltage V _{IN} , NMK05 types	7V
Input voltage V _{IN} , NMK12 types	15V
Input voltage V _{IN} , NMK15 types	18V
Input voltage V _{IN} , NMK24 types	28V

ISOLATION CHARACTERISTICS

Parameter	Conditions	Min.	Typ.	Max.	Units
Isolation test voltage	Flash tested for 1 minute	3000			VDC
Resistance	Viso= 1000VDC	10			GΩ

GENERAL CHARACTERISTICS

Parameter	Conditions	Min.	Typ.	Max.	Units
Switching frequency			60		kHz

TEMPERATURE CHARACTERISTICS

Parameter	Conditions	Min.	Typ.	Max.	Units
Specification	All output types	-40		85	°C
Storage		-50		125	
Case Temperature above ambient	5V output types & NMK1509SAC (Except NMK1505S(A)C & NMK2405S(A))			28	
	NMK1505S(A)C & NMK2405S(A)C			32	
	All other output types			25	
Cooling	Free air convection				

TEMPERATURE DERATING GRAPH

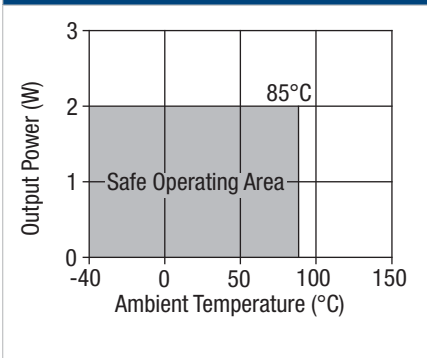

TOLERANCE ENVELOPE

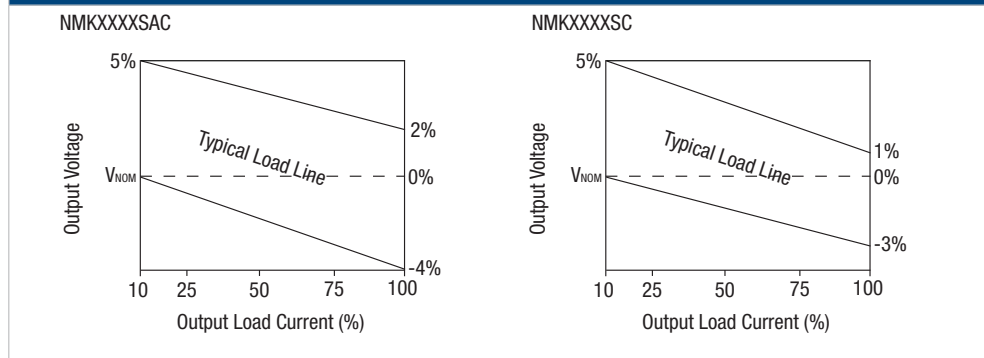

TECHNICAL NOTES

ISOLATION VOLTAGE

'Hi Pot Test', 'Flash Tested', 'Withstand Voltage', 'Proof Voltage', 'Dielectric Withstand Voltage' & 'Isolation Test Voltage' are all terms that relate to the same thing, a test voltage, applied for a specified time, across a component designed to provide electrical isolation, to verify the integrity of that isolation.

Murata Power Solutions NMK series of DC/DC converters are all 100% production tested at their stated isolation voltage. This is 3kVDC for 1 minute.

A question commonly asked is, "What is the continuous voltage that can be applied across the part in normal operation?"

The NMK series has been recognized by Underwriters Laboratory for functional insulation. Both input and output should normally be maintained within SELV limits i.e. less than 42.4V peak, or 60VDC. The isolation test voltage represents a measure of immunity to transient voltages and the part should never be used as an element of a safety isolation system. The part could be expected to function correctly with several hundred volts offset applied continuously across the isolation barrier; but then the circuitry on both sides of the barrier must be regarded as operating at an unsafe voltage and further isolation/insulation systems must form a barrier between these circuits and any user-accessible circuitry according to safety standard requirements.

REPEATED HIGH-VOLTAGE ISOLATION TESTING

It is well known that repeated high-voltage isolation testing of a barrier component can actually degrade isolation capability, to a lesser or greater degree depending on materials, construction and environment. The NMK series has toroidal isolation transformers, with no additional insulation between primary and secondary windings of enameled wire. While parts can be expected to withstand several times the stated test voltage, the isolation capability does depend on the wire insulation. Any material, including this enamel (typically polyurethane) is susceptible to eventual chemical degradation when subject to very high applied voltages thus implying that the number of tests should be strictly limited. We therefore strongly advise against repeated high voltage isolation testing, but if it is absolutely required, that the voltage be reduced by 20% from specified test voltage.

This consideration equally applies to agency recognized parts rated for better than functional isolation where the wire enamel insulation is always supplemented by a further insulation system of physical spacing or barriers.

SAFETY APPROVAL

The NMK series has been recognised by Underwriters Laboratory (UL) to UL 60950 for functional insulation in a maximum ambient temperature of 85°C and/or case temperature limit of 130°C. Case temperature measured on the face opposite the pins. File number E179522 applies.

The NMK Series of converters are not internally fused so to meet the requirements of UL 60950 an anti-surge input line fuse should always be used as below:

NMK05xxSC/SAC: 2A
 NMK12xxSC/SAC: 0.75A
 NMK15xxSC/SAC: 0.75A
 NMK24xxSC/SAC: 0.375A

RoHS COMPLIANT INFORMATION



This series is compatible with RoHS soldering systems with a peak wave solder temperature of 260°C for 10 seconds. The pin termination finish on the SIP package type is Tin Plate, Hot Dipped over Matte Tin with Nickel Preplate. The DIP types are Matte Tin over Nickel Preplate. Both types in this series are backward compatible with Sn/Pb soldering systems. For further information, please visit www.murata-ps.com/rohs

APPLICATION NOTES

Minimum Load

The minimum load to meet datasheet specification is 10% of the full rated load across the specified input voltage range. Lower than 10% minimum loading will result in an increase in output voltage, which may rise to typically double the specified output voltage if the output load falls to less than 5%.

Unbalanced Load

The NMK series offers unbalanced loading capabilities with up to the full 2W available from a single output. However, when operated in this mode there may be a slight performance decrease in efficiency and load regulation.

APPLICATION NOTES (continued)

Ripple & Noise Characterisation Method

All measurement to be taken with the following components connected to the UUT as detailed below.
50 Ohm coax cable, solder connections one end, BNC plug at the other end.

C1	1µF X7R multilayer ceramic capacitor rated at minimum 3 x the output voltage of the UUT
C2	10µF tantalum capacitor rated at minimum 1.5 x the output voltage of the UUT with ESR of less than 100 milliohms at 100 kHz e.g. AVX TPS
C3	100nF multilayer ceramic capacitor, general purpose
R1	450 Ohm resistor, carbon film, ±1%
R2	50 Ohm BNC termination
T1	3T of the coax cable through a ferrite toroid eg Ferroxcube TN32/19/13-3E25
RLOAD	Resistive load at the UUT maximum rating. Connections via twisted wires.

Differential Mode Noise Test Schematic

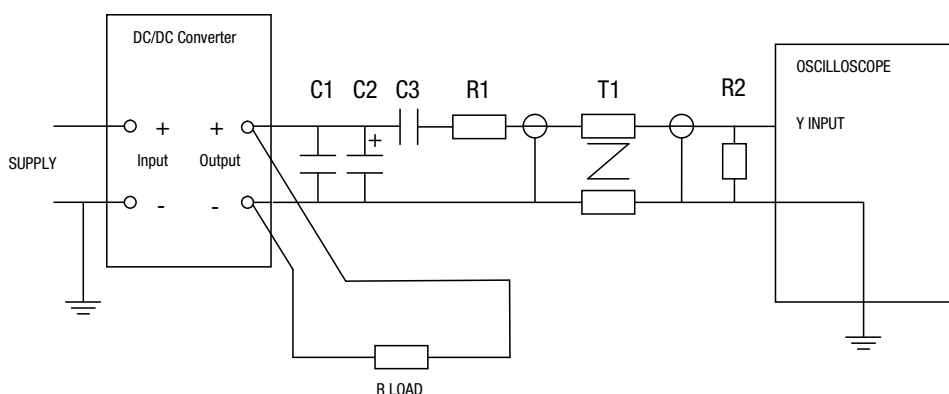

EFFICIENCY VS LOAD

NMK05XXSAC

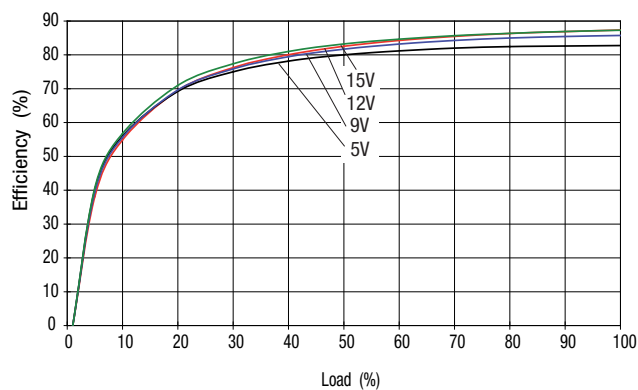

NMK12XXSAC

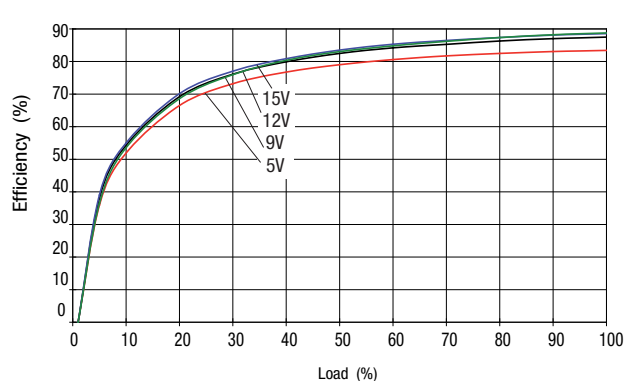

EFFICIENCY VS LOAD (continued)

NMK15XXSAC

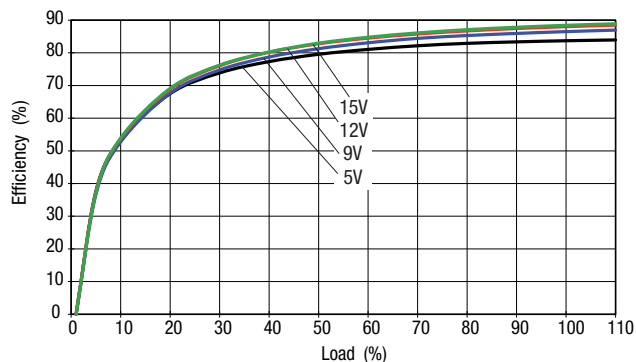

NMK24XXSAC

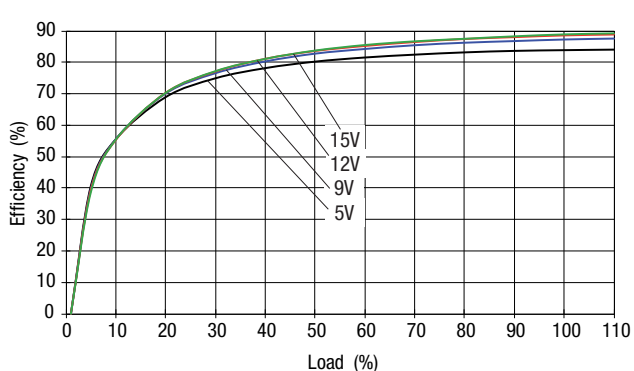

NMK05XXSC

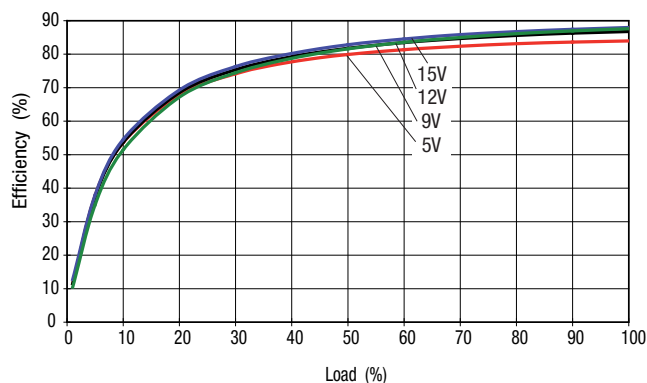

NMK12XXSC

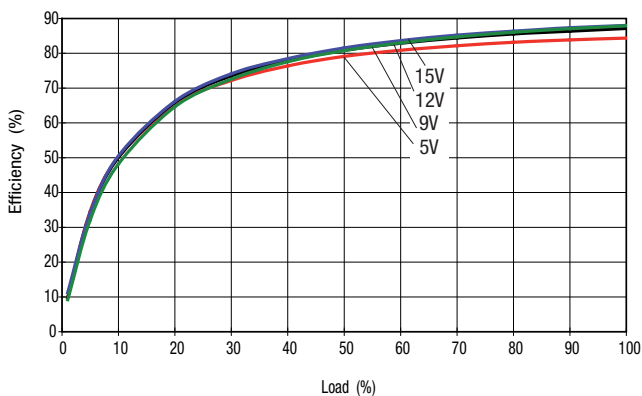

NMK15XXSC

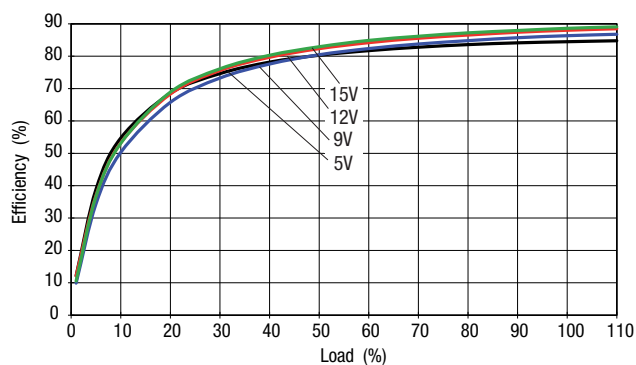

NMK24XXSC

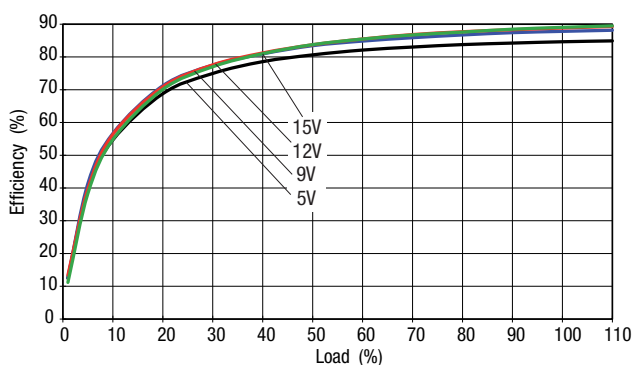

PACKAGE SPECIFICATIONS

MECHANICAL DIMENSIONS

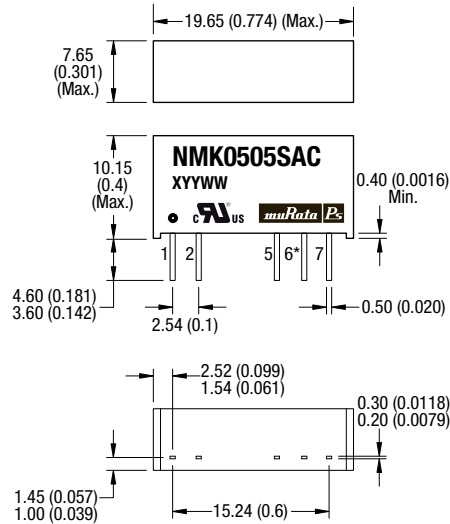

Weight: 2.8g

* Pin not fitted on single output variants.
All dimensions in mm ± 0.25 (inches ± 0.01). All pins on a 2.54 (0.1) pitch and within ± 0.25 (0.01) of true position.

RECOMMENDED FOOTPRINT DETAILS

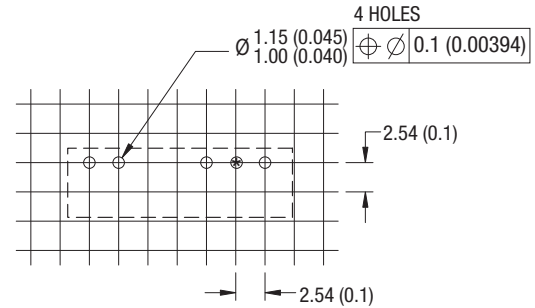

* Hole not required for single output variants.
Unless otherwise stated all dimensions in mm (inches) ± 0.5 mm.

TUBE OUTLINE DIMENSIONS

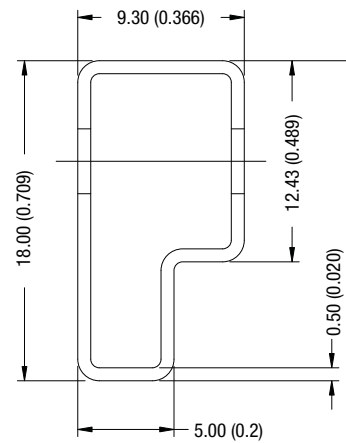

Unless otherwise stated all dimensions in mm (inches) ± 0.5 mm.
Tube length : 520mm ± 2 mm (20.47). Tube Quantity : 25

PIN CONNECTIONS

Single output variants		Dual output variants	
Pin	Function	Pin	Function
1	+VIN	1	+VIN
2	-VIN	2	-VIN
5	-VOUT	5	-VOUT
7	+VOUT	6	OV
		7	+VOUT

Murata Power Solutions, Inc.
11 Cabot Boulevard, Mansfield, MA 02048-1151 U.S.A.
ISO 9001 and 14001 REGISTERED



**This product is subject to the following operating requirements and the Life and Safety Critical Application Sales Policy:
Refer to: <http://www.murata-ps.com/requirements/>**

Murata Power Solutions, Inc. makes no representation that the use of its products in the circuits described herein, or the use of other technical information contained herein, will not infringe upon existing or future patent rights. The descriptions contained herein do not imply the granting of licenses to make, use, or sell equipment constructed in accordance therewith. Specifications are subject to change without notice.
© 2012 Murata Power Solutions, Inc.



Компания «ЭлектроПласт» предлагает заключение долгосрочных отношений при поставках импортных электронных компонентов на взаимовыгодных условиях!

Наши преимущества:

- Оперативные поставки широкого спектра электронных компонентов отечественного и импортного производства напрямую от производителей и с крупнейших мировых складов;
- Поставка более 17-ти миллионов наименований электронных компонентов;
- Поставка сложных, дефицитных, либо снятых с производства позиций;
- Оперативные сроки поставки под заказ (от 5 рабочих дней);
- Экспресс доставка в любую точку России;
- Техническая поддержка проекта, помощь в подборе аналогов, поставка прототипов;
- Система менеджмента качества сертифицирована по Международному стандарту ISO 9001;
- Лицензия ФСБ на осуществление работ с использованием сведений, составляющих государственную тайну;
- Поставка специализированных компонентов (Xilinx, Altera, Analog Devices, Intersil, Interpoint, Microsemi, Aeroflex, Peregrine, Syfer, Eurofarad, Texas Instrument, Miteq, Cobham, E2V, MA-COM, Hittite, Mini-Circuits, General Dynamics и др.);

Помимо этого, одним из направлений компании «ЭлектроПласт» является направление «Источники питания». Мы предлагаем Вам помощь Конструкторского отдела:

- Подбор оптимального решения, техническое обоснование при выборе компонента;
- Подбор аналогов;
- Консультации по применению компонента;
- Поставка образцов и прототипов;
- Техническая поддержка проекта;
- Защита от снятия компонента с производства.



Как с нами связаться

Телефон: 8 (812) 309 58 32 (многоканальный)

Факс: 8 (812) 320-02-42

Электронная почта: org@eplast1.ru

Адрес: 198099, г. Санкт-Петербург, ул. Калинина, дом 2, корпус 4, литера А.