

Features

- Small, Surface Mount Package
- Ideally suited for Automated Assembly Processes
- Very Sharp Breakdown Characteristics
- Very Tight Tolerance on Zener Breakdown Voltage
- **Totally Lead-Free & Fully RoHS Compliant (Notes 1 & 2)**
- **Halogen and Antimony Free. "Green" Device (Note 3)**

Mechanical Data

- Case: SOD323
- Case Material: UL Flammability Classification Rating 94V-0
- Moisture Sensitivity: Level 1 per J-STD-020D
- Terminal Connections: Cathode Band
- Terminals: Finish - Matte Tin annealed over Alloy 42 leadframe. Solderable per MIL-STD-202, Method 208 
- Weight: 0.004 grams (approximate)



Top View

Ordering Information (Note 4)

Device	Packaging	Shipping
(Type Number)-7*	SOD323	3000/Tape & Reel
(Type Number)-13* (Note 5)	SOD323	10000/Tape & Reel

* For (Type Number), please see the Electrical Characteristics Table. Example: 6.2V Zener = UDZ6V2B-7.

- Notes:
1. No purposely added lead. Fully EU Directive 2002/95/EC (RoHS) & 2011/65/EU (RoHS 2) compliant.
 2. See http://www.diodes.com/quality/lead_free.html for more information about Diodes Incorporated's definitions of Halogen- and Antimony-free, "Green" and Lead-free.
 3. Halogen- and Antimony-free "Green" products are defined as those which contain <900ppm bromine, <900ppm chlorine (<1500ppm total Br + Cl) and <1000ppm antimony compounds.
 4. For packaging details, go to our website at <http://www.diodes.com/products/packages.html>
 5. Devices are readily available on 13" reels for select voltages only. For other voltages, devices can be made available on 13" reels upon request. Please Contact your Diodes Inc. sales representative for additional details.

Marking Information



xx = Product Type Marking Code
(See Electrical Characteristics Table)

Thermal Characteristics

Characteristic	Symbol	Value	Unit
Power Dissipation (Note 6)	P_D	200	mW
Thermal Resistance Junction to Ambient Air (Note 6)	$R_{\theta JA}$	625	°C/W
Operating and Storage Temperature Range	T_J, T_{STG}	-65 to +150	°C

Electrical Characteristics (@ $T_A = +25^\circ\text{C}$, unless otherwise specified.)

Type Number	Marking Code	Zener Voltage Range (Note 7)			Maximum Zener Impedance (Note 8)			Maximum Reverse Current (Note 7)	
		$V_{ZT} @ I_{ZT}$		I_{ZT}	$Z_{ZT} @ I_{ZT}$	$Z_{ZK} @ I_{ZK}$	I_{ZK}	I_R	V_R
		Min (V)	Max (V)	mA	Ω		mA	μA	V
UDZ3V6B (Note 9)	B7	3.600	3.845	5	100	1000	1.0	10	1.0
UDZ3V9B (Note 9)	B8	3.890	4.160	5	100	1000	1.0	5	1.0
UDZ4V3B (Note 9)	B9	4.170	4.430	5	100	1000	1.0	5	1.0
UDZ4V7B (Note 9)	BA	4.550	4.750	5	100	800	0.5	2	1.0
UDZ5V1B (Note 9)	BB	4.980	5.200	5	80	500	0.5	2	1.5
UDZ5V6B	BC	5.490	5.730	5	60	200	0.5	1	2.5
UDZ6V2B	BD	6.060	6.330	5	60	100	0.5	1	3.0
UDZ6V8B	BE	6.650	6.930	5	40	60	0.5	0.5	3.5
UDZ7V5B (Note 9)	BF	7.280	7.600	5	30	60	0.5	0.5	4.0
UDZ8V2B	BG	8.020	8.360	5	30	60	0.5	0.5	5.0
UDZ9V1B	BH	8.850	9.230	5	30	60	0.5	0.5	6.0
UDZ10B	BI	9.770	10.210	5	30	60	0.5	0.1	7.0
UDZ11B	BJ	10.760	11.220	5	30	60	0.5	0.1	8.0
UDZ12B	BK	11.740	12.240	5	30	80	0.5	0.1	9.0
UDZ13B	BL	12.910	13.490	5	37	80	0.5	0.1	10.0
UDZ15B	BM	14.340	14.980	5	42	80	0.5	0.1	11.0

- Notes:
6. Part mounted on FR-4 PC board with recommended pad layout, which can be found on our website at <http://www.diodes.com/datasheets/ap02001.pdf>.
 7. Short duration pulse test used to minimize self-heating effect.
 8. The Zener impedances (Z_{ZT} , Z_{ZK}) are measured by superimposing a minute alternating current on the regulated current (I_Z).
 9. AEC-Q101 qualified

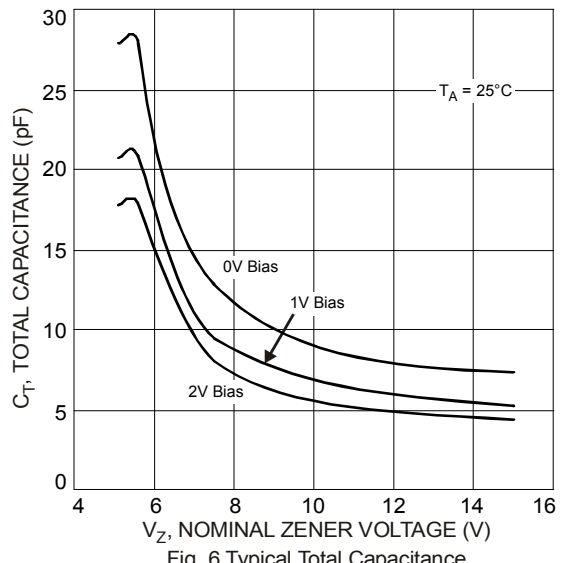
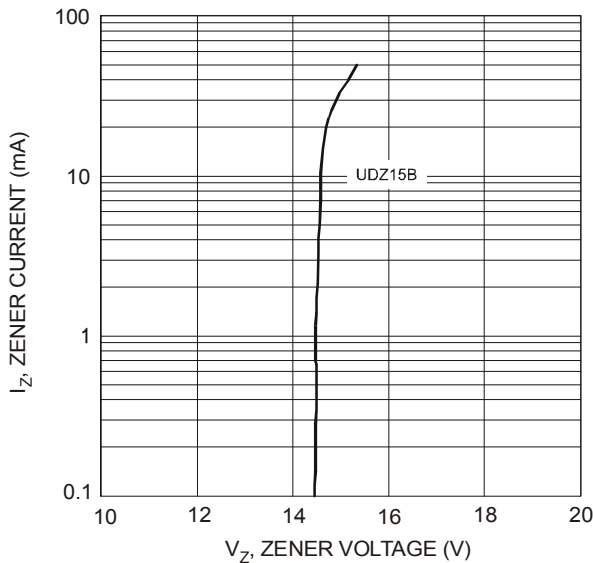
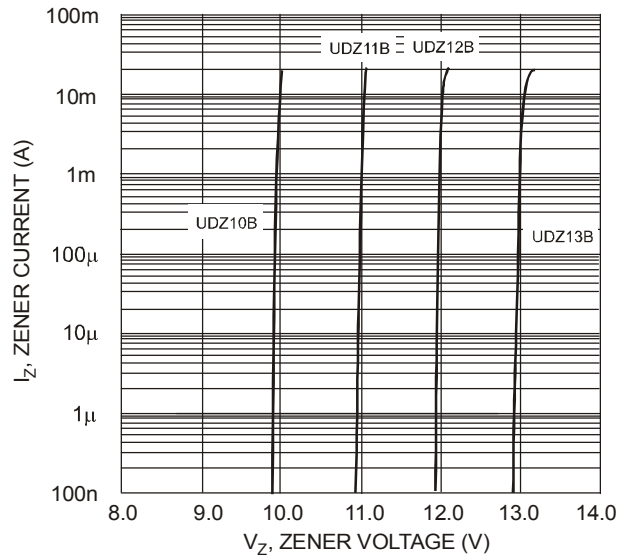
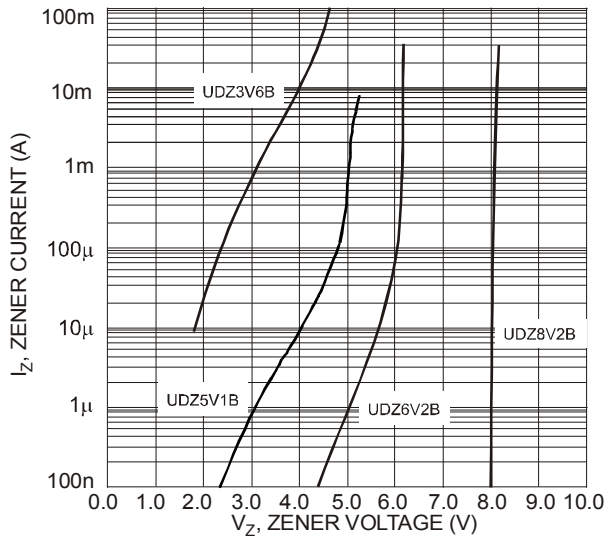
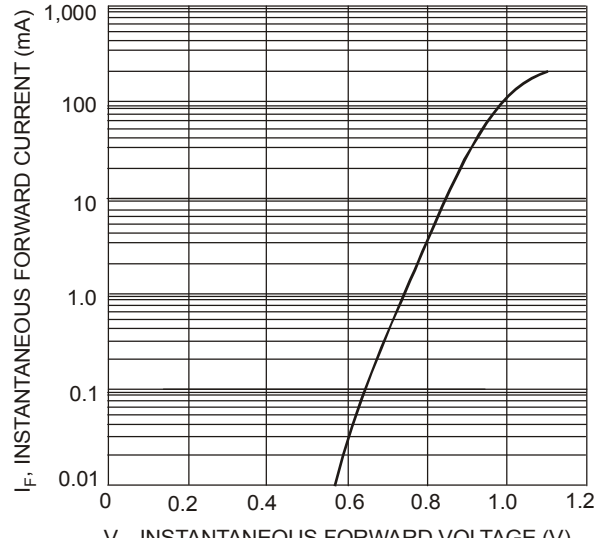
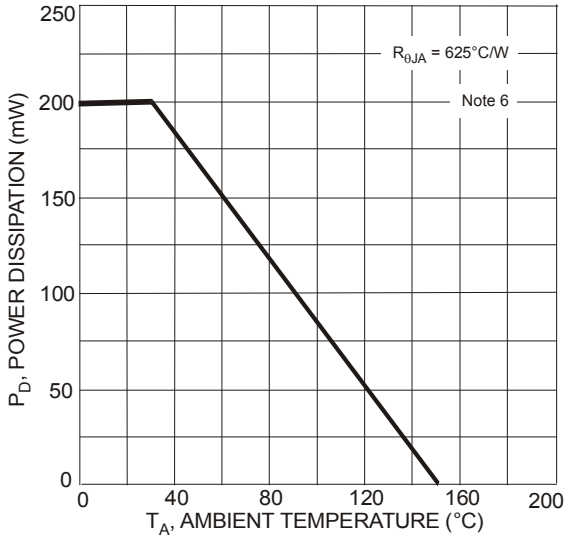

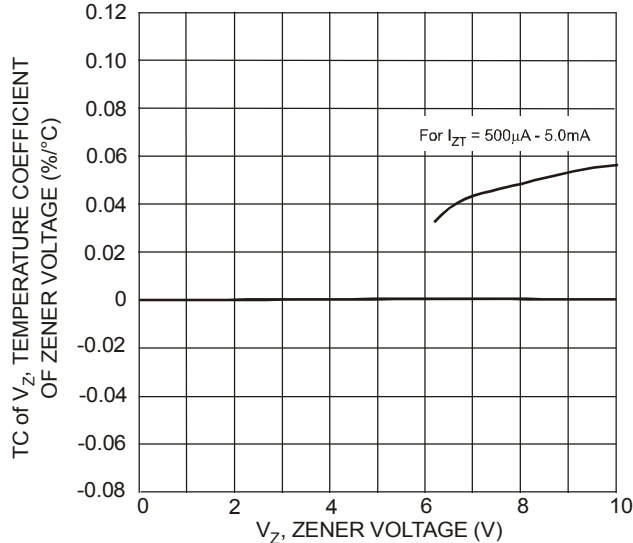

Fig. 7 Typical Temperature Coefficient of Zener Voltage vs. Zener Voltage, UDZ6V2B-UDZ10B

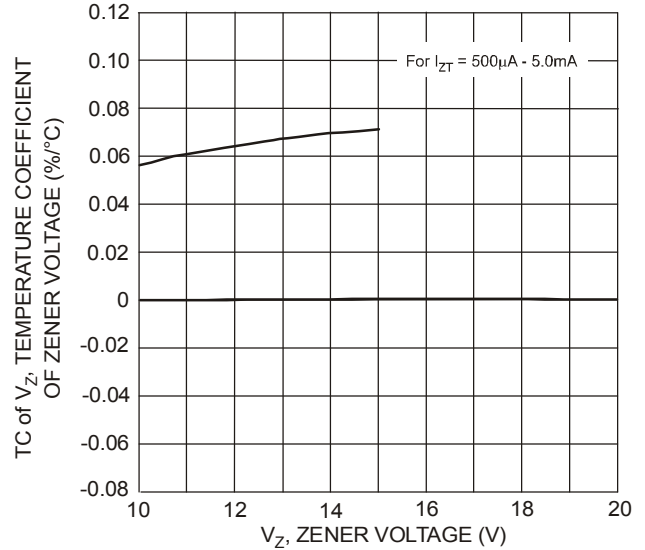
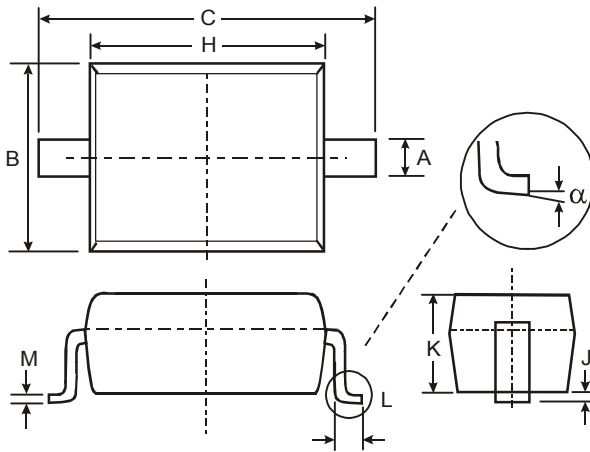

Fig. 8 Typical Temperature Coefficient of Zener Voltage vs. Zener Voltage, UDZ10B-UDZ15B

Package Outline Dimensions

Please see AP02002 at <http://www.diodes.com/datasheets/ap02002.pdf> for latest version.



SOD323		
Dim	Min	Max
A	0.25	0.35
B	1.20	1.40
C	2.30	2.70
H	1.60	1.80
J	0.00	0.10
K	1.0	1.1
L	0.20	0.40
M	0.10	0.15
α	0°	8°
All Dimensions in mm		

Suggested Pad Layout

Please see AP02001 at <http://www.diodes.com/datasheets/ap02001.pdf> for the latest version.

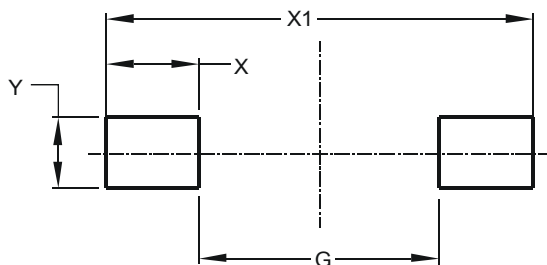

Dimensions	Value (in mm)
G	1.520
X	0.590
X1	2.700
Y	0.450

IMPORTANT NOTICE

DIODES INCORPORATED MAKES NO WARRANTY OF ANY KIND, EXPRESS OR IMPLIED, WITH REGARDS TO THIS DOCUMENT, INCLUDING, BUT NOT LIMITED TO, THE IMPLIED WARRANTIES OF MERCHANTABILITY AND FITNESS FOR A PARTICULAR PURPOSE (AND THEIR EQUIVALENTS UNDER THE LAWS OF ANY JURISDICTION).

Diodes Incorporated and its subsidiaries reserve the right to make modifications, enhancements, improvements, corrections or other changes without further notice to this document and any product described herein. Diodes Incorporated does not assume any liability arising out of the application or use of this document or any product described herein; neither does Diodes Incorporated convey any license under its patent or trademark rights, nor the rights of others. Any Customer or user of this document or products described herein in such applications shall assume all risks of such use and will agree to hold Diodes Incorporated and all the companies whose products are represented on Diodes Incorporated website, harmless against all damages.

Diodes Incorporated does not warrant or accept any liability whatsoever in respect of any products purchased through unauthorized sales channel. Should Customers purchase or use Diodes Incorporated products for any unintended or unauthorized application, Customers shall indemnify and hold Diodes Incorporated and its representatives harmless against all claims, damages, expenses, and attorney fees arising out of, directly or indirectly, any claim of personal injury or death associated with such unintended or unauthorized application.

Products described herein may be covered by one or more United States, international or foreign patents pending. Product names and markings noted herein may also be covered by one or more United States, international or foreign trademarks.

This document is written in English but may be translated into multiple languages for reference. Only the English version of this document is the final and determinative format released by Diodes Incorporated.

LIFE SUPPORT

Diodes Incorporated products are specifically not authorized for use as critical components in life support devices or systems without the express written approval of the Chief Executive Officer of Diodes Incorporated. As used herein:

A. Life support devices or systems are devices or systems which:

1. are intended to implant into the body, or
2. support or sustain life and whose failure to perform when properly used in accordance with instructions for use provided in the labeling can be reasonably expected to result in significant injury to the user.

B. A critical component is any component in a life support device or system whose failure to perform can be reasonably expected to cause the failure of the life support device or to affect its safety or effectiveness.

Customers represent that they have all necessary expertise in the safety and regulatory ramifications of their life support devices or systems, and acknowledge and agree that they are solely responsible for all legal, regulatory and safety-related requirements concerning their products and any use of Diodes Incorporated products in such safety-critical, life support devices or systems, notwithstanding any devices- or systems-related information or support that may be provided by Diodes Incorporated. Further, Customers must fully indemnify Diodes Incorporated and its representatives against any damages arising out of the use of Diodes Incorporated products in such safety-critical, life support devices or systems.

Copyright © 2013, Diodes Incorporated

www.diodes.com



Компания «ЭлектроПласт» предлагает заключение долгосрочных отношений при поставках импортных электронных компонентов на взаимовыгодных условиях!

Наши преимущества:

- Оперативные поставки широкого спектра электронных компонентов отечественного и импортного производства напрямую от производителей и с крупнейших мировых складов;
- Поставка более 17-ти миллионов наименований электронных компонентов;
- Поставка сложных, дефицитных, либо снятых с производства позиций;
- Оперативные сроки поставки под заказ (от 5 рабочих дней);
- Экспресс доставка в любую точку России;
- Техническая поддержка проекта, помощь в подборе аналогов, поставка прототипов;
- Система менеджмента качества сертифицирована по Международному стандарту ISO 9001;
- Лицензия ФСБ на осуществление работ с использованием сведений, составляющих государственную тайну;
- Поставка специализированных компонентов (Xilinx, Altera, Analog Devices, Intersil, Interpoint, Microsemi, Aeroflex, Peregrine, Syfer, Eurofarad, Texas Instrument, Miteq, Cobham, E2V, MA-COM, Hittite, Mini-Circuits, General Dynamics и др.);

Помимо этого, одним из направлений компании «ЭлектроПласт» является направление «Источники питания». Мы предлагаем Вам помощь Конструкторского отдела:

- Подбор оптимального решения, техническое обоснование при выборе компонента;
- Подбор аналогов;
- Консультации по применению компонента;
- Поставка образцов и прототипов;
- Техническая поддержка проекта;
- Защита от снятия компонента с производства.



Как с нами связаться

Телефон: 8 (812) 309 58 32 (многоканальный)

Факс: 8 (812) 320-02-42

Электронная почта: org@eplast1.ru

Адрес: 198099, г. Санкт-Петербург, ул. Калинина, дом 2, корпус 4, литера А.