

## SDP Biased Series - 5x6 QFN

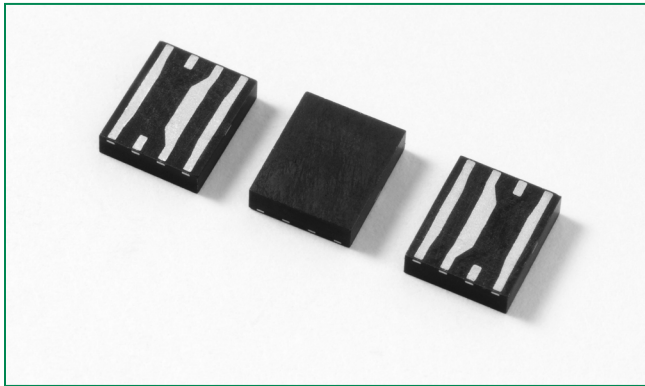

### Agency Approvals

Agency	Agency File Number
	E133083

### Pinout Designation

Tip in	1	8	Tip out
- Bias	2	7	+ Bias
Ground	3	6	Ground
Ring in	4	5	Ring out

### Schematic Symbol

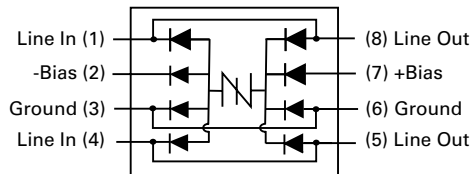

### Description

This new SDP Biased series provides overvoltage protection for applications such as VDSL2, ADSL2, and ADSL2+ with minimal effect on data signals. This latest silicon design innovation results in a capacitive loading characteristic that is compatible with these high bandwidth applications. This surface mount QFN package provides a surge capability that exceeds most worldwide standards and recommendations for lightning surge withstand capability of secondary protectors.

### Features & Benefits

- Compatible with VDSL2 (30MHz)
- Balanced overvoltage protection
- Low distortion
- Low insertion loss
- Low profile
- SO-8 footprint compatible
- Fails short circuit when surged in excess of ratings
- 2nd level interconnect is Pb-free per IPC/JEDEC J-STD-609A.01

### Applicable Global Standards

- TIA-968-A
- TIA-968-B
- ITU K.20/21 Enhanced Level
- ITU K.20/21 Basic Level
- IEC 61000-4-5
- GR 1089 Inter-building
- GR 1089 Intra-building
- YD/T 1082
- YD/T 993
- YD/T 950

### Electrical Characteristics

Part Number	Marking	$V_{DRM} @ I_{DRM}=5\mu A$	$V_S @ 100V/\mu s$	$I_H$	$I_S$	$I_T$	$V_T @ I_T=2.2$ Amps	Capacitance
		V min	V max	mA min	mA max	A max	V max	
SDP0080Q38CB	SDP-8C	6	25	50	800	2.2	8	See Capacitance vs Voltage Chart
SDP0220Q38CB	SDP02C	16	30	50	800	2.2	8	
SDP0640Q38CB	SDP06C	58	77	150	800	2.2	8	
SDP0720Q38CB	SDP07C	65	88	150	800	2.2	8	
SDP0900Q38CB	SDP09C	75	98	150	800	2.2	8	
SDP1100Q38CB	SDP11C	90	130	150	800	2.2	8	
SDP1300Q38CB	SDP13C	120	160	150	800	2.2	8	
SDP1800Q38CB	SDP18C	170	220	150	800	2.2	8	
SDP2600Q38CB	SDP26C	220	300	150	800	2.2	8	
SDP3100Q38CB	SDP31C	275	350	150	800	2.2	8	
SDP3500Q38CB	SDP35C	320	400	150	800	2.2	8	

Notes:

- Absolute maximum ratings measured at  $T_A = 25^\circ C$  (unless otherwise noted).
- Devices are bi-directional (unless otherwise noted).
- Part with \* is under development.

**V-I: Characteristics**

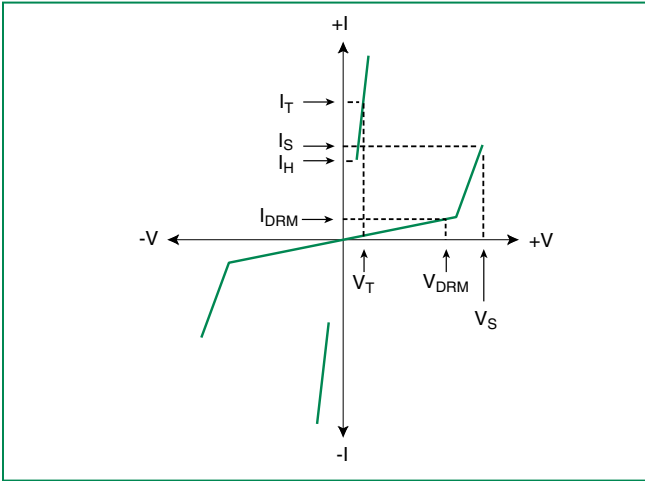

**Capacitance vs. Voltage\***

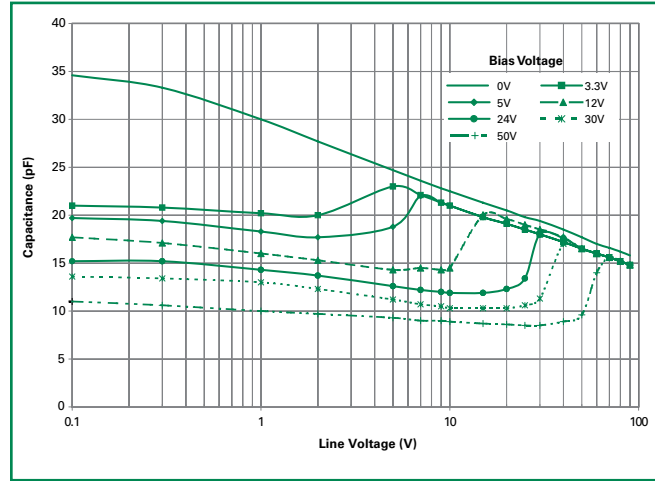

\* Bias voltage must be lower than  $V_{DRM}$

**50/60Hz Ratings**

Parameter Name	Test Conditions	Value	Units
$I_{TSM}$ Maximum non-repetitive on-state current, 50/60Hz	0.5s	6.5	A
	1s	4.6	
	2s	3.4	
	5s	2.3	
	30s	1.3	
	900s	0.73	

**Surge Ratings**

Series	$I_{PP}$				$I_{TSM}$
	2x10 $\mu$ s	1.2x50 $\mu$ s/8x20 $\mu$ s	10x700/5x310 $\mu$ s	10x1000 $\mu$ s	600V <sub>RMS</sub> 1 cycle
	A min	A min	A min	A min	A <sub>RMS</sub>
C	500	400	200	100	30

Notes:  
 - Peak pulse current rating ( $I_{pp}$ ) is repetitive and guaranteed for the life of the product.  
 -  $I_{pp}$  ratings applicable over temperature range of -40°C to +85°C  
 - The device must initially be in thermal equilibrium with -40°C  $\leq$   $T_j$   $\leq$  +150°C

**Thermal Considerations**

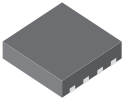
Package	Symbol	Parameter	Value	Unit
 5x6 QFN	$T_J$	Junction Temperature	-40 to +150	°C
	$T_{STG}$	Storage Temperature Range	-40 to +150	°C
	$R_{\theta JA}$	Thermal Resistance: Junction to Ambient	100	°C/W

**Normalized  $V_S$  Change vs. Junction Temperature**

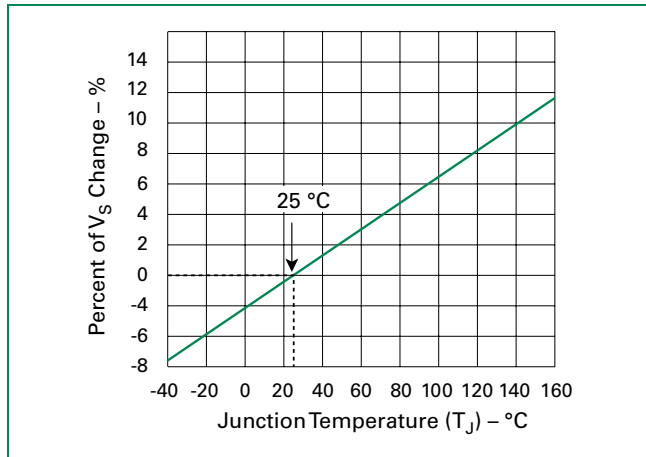

**Normalized DC Holding Current vs. Case Temperature**

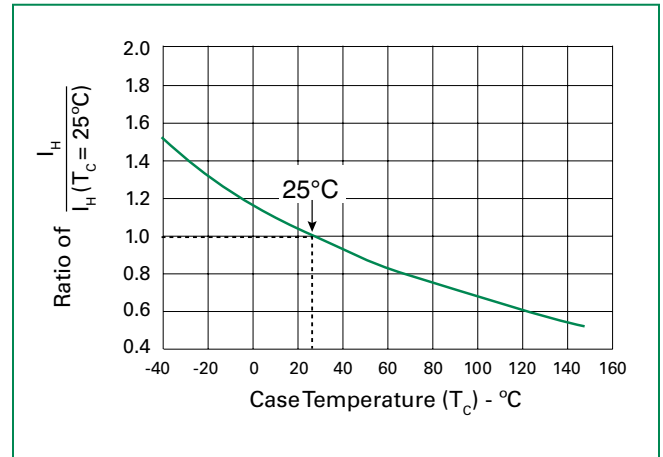

**Soldering Parameters**

Reflow Condition		Pb-Free assembly (see Fig. 1)
Pre Heat	-Temperature Min ( $T_{s(\min)}$ )	+150°C
	-Temperature Max ( $T_{s(\max)}$ )	+200°C
	-Time (Min to Max) ( $t_s$ )	60-180 secs.
Average ramp up rate (Liquidus Temp ( $T_L$ ) to peak)		3°C/sec. Max.
$T_{s(\max)}$ to $T_L$ - Ramp-up Rate		3°C/sec. Max.
Reflow	-Temperature ( $T_L$ ) (Liquidus)	+217°C
	-Temperature ( $t_L$ )	60-150 secs.
Peak Temp ( $T_p$ )		+260(+0/-5)°C
Time within 5°C of actual Peak Temp ( $t_p$ )		30 secs. Max.
Ramp-down Rate		6°C/sec. Max.
Time 25°C to Peak Temp ( $T_p$ )		8 min. Max.
Do not exceed		+260°C

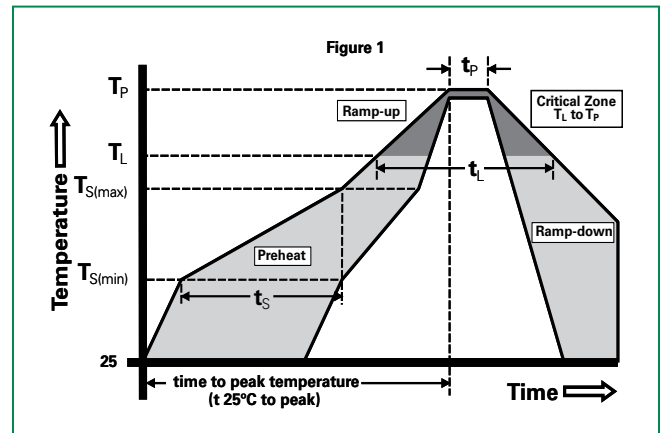

**Physical Specifications**

<b>Lead Material</b>	Copper Alloy
<b>Terminal Finish</b>	100% Matte-Tin Plated
<b>Body Material</b>	UL recognized epoxy meeting flammability classification 94V-0

**Additional Information**



Datasheet



Resources



Samples

**Environmental Specifications**

<b>High Temp Voltage Blocking</b>	80% Rated $V_{DRM}$ ( $V_{AC}$ Peak) +125°C or +150°C, 504 or 1008 hrs. MIL-STD-750 (Method 1040) JEDEC, JESD22-A-101
<b>Temp Cycling</b>	-65°C to +150°C, 15 min. dwell, 10 up to 100 cycles. MIL-STD-750 (Method 1051) EIA/JEDEC, JESD22-A104
<b>Biased Temp &amp; Humidity</b>	52 $V_{DC}$ (+85°C) 85%RH, 504 up to 1008 hrs. EIA/JEDEC, JESD22-A-101
<b>High Temp Storage</b>	+150°C 1008 hrs. MIL-STD-750 (Method 1031) JEDEC, JESD22-A-101
<b>Low Temp Storage</b>	-65°C, 1008 hrs.
<b>Thermal Shock</b>	0°C to +100°C, 5 min. dwell, 10 sec. transfer, 10 cycles. MIL-STD-750 (Method 1056) JEDEC, JESD22-A-106
<b>Resistance to Solder Heat</b>	+260°C, 30 secs. MIL-STD-750 (Method 2031)
<b>Moisture Sensitivity Level</b>	85%RH, +85°C, 168 hrs., 3 reflow cycles (+260°C Peak). JEDEC-J-STD-020, Level 1

**Dimensions — 5x6 QFN**

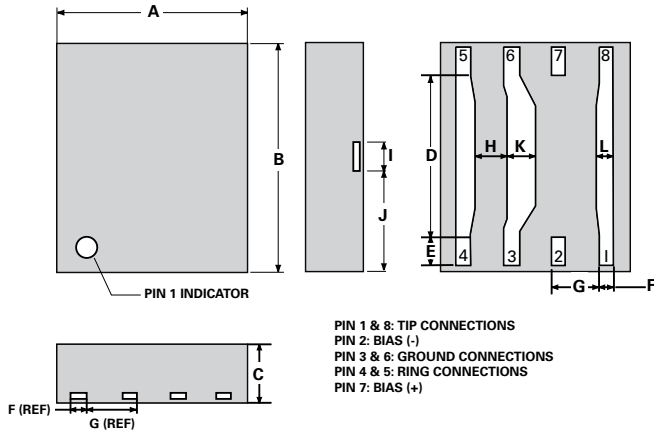

Dimension	Inches		Millimeters	
	Min	Max	Min	Max
<b>A</b>	0.187	0.207	4.745	5.253
<b>B</b>	0.226	0.246	5.745	6.253
<b>C</b>	0.054	0.064	1.374	1.628
<b>D</b>	0.165	0.171	4.199	4.351
<b>E</b>	0.027	0.033	0.686	0.838
<b>F</b>	0.011	0.017	0.279	0.432
<b>G</b>	0.047	0.053	1.194	1.346
<b>H</b>	0.032	0.038	0.800	0.953
<b>I</b>	0.027	0.033	0.686	0.838
<b>J</b>	0.100	0.106	2.540	2.692
<b>K</b>	0.027	0.033	0.686	0.838
<b>L</b>	0.015	0.021	0.381	0.533

**5x6 QFN Solder Pad Layout**

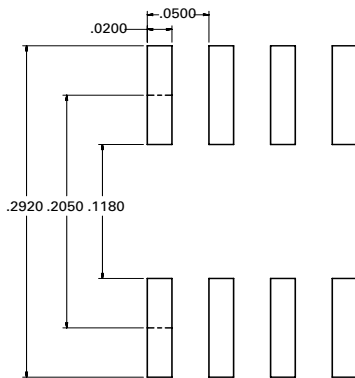

**Part Numbering**

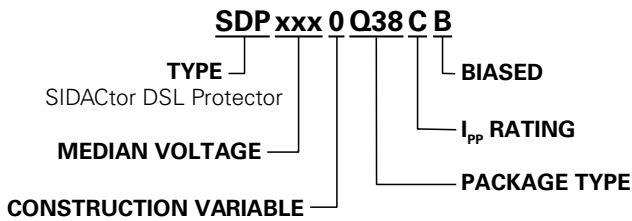

**Part Marking**

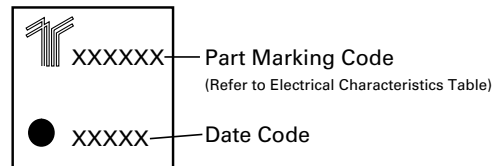

**Packing Options**

Package Type	Description	Quantity	Added Suffix	Industry Standard
Q38	5x6x1.5 QFN Tape and Reel Pack	4000	N/A	EIA-481-D

**Tape and Reel Specifications — 5x6 QFN**

Reel Dimension

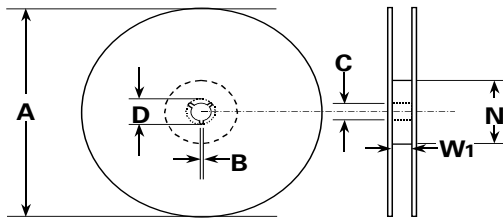

Tape Leader and Trailer Dimensions

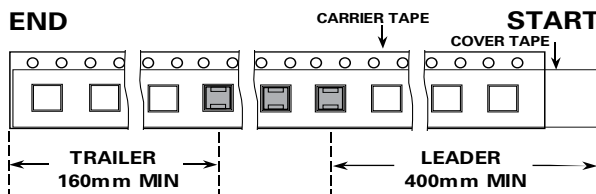

Tape Dimension Items

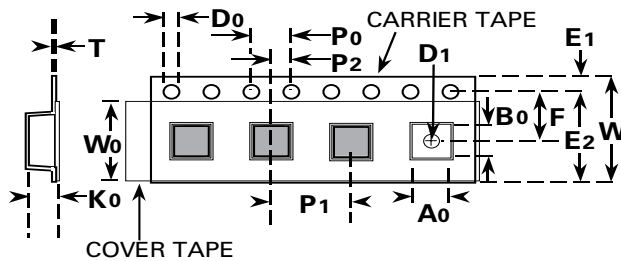

Symbols	Description	Inches		Millimeters	
		Min	Max	Min	Max
<b>A</b>	Reel Diameter	N/A	12.992	N/A	330.0
<b>B</b>	Drive Spoke Width	0.059	N/A	1.50	N/A
<b>C</b>	Arbor Hole Diameter	0.504	0.531	12.80	13.50
<b>D</b>	Drive Spoke Diameter	0.795	N/A	20.20	N/A
<b>N</b>	Hub Diameter	1.969	N/A	50.00	N/A
<b>W<sub>1</sub></b>	Reel Inner Width at Hub	0.488	0.567	12.40	14.40
<b>A<sub>0</sub></b>	Pocket Width at Bottom	0.204	0.212	5.20	5.40
<b>B<sub>0</sub></b>	Pocket Length at Bottom	0.244	0.252	6.20	6.40
<b>D<sub>0</sub></b>	Feed Hole Diameter	0.059	0.063	1.50	1.60
<b>D<sub>1</sub></b>	Pocket Hole Diameter	0.059	N/A	1.50	N/A
<b>E<sub>1</sub></b>	Feed Hole Position 1	0.065	0.073	1.65	1.85
<b>E<sub>2</sub></b>	Feed Hole Position 2	0.400	0.408	10.15	10.35
<b>F</b>	Feed Hole Center - Pocket Hole Center 2	0.212	0.220	5.40	5.60
<b>K<sub>0</sub></b>	Pocket Depth	0.067	0.075	1.70	1.90
<b>P<sub>0</sub></b>	Feed Hole Pitch	0.153	0.161	3.90	4.10
<b>P<sub>1</sub></b>	Component Spacing	0.311	0.319	7.90	8.10
<b>P<sub>2</sub></b>	Feed Hole Center - Pocket Hole Center 1	0.077	0.081	1.90	2.10
<b>T</b>	Carrier Tape Thickness	0.010	0.014	0.25	0.35
<b>W</b>	Embossed Carrier Tape Width	0.460	0.484	11.70	12.30
<b>W<sub>0</sub></b>	Cover Tape Width	0.358	0.366	9.10	9.30



Компания «ЭлектроПласт» предлагает заключение долгосрочных отношений при поставках импортных электронных компонентов на взаимовыгодных условиях!

Наши преимущества:

- Оперативные поставки широкого спектра электронных компонентов отечественного и импортного производства напрямую от производителей и с крупнейших мировых складов;
- Поставка более 17-ти миллионов наименований электронных компонентов;
- Поставка сложных, дефицитных, либо снятых с производства позиций;
- Оперативные сроки поставки под заказ (от 5 рабочих дней);
- Экспресс доставка в любую точку России;
- Техническая поддержка проекта, помощь в подборе аналогов, поставка прототипов;
- Система менеджмента качества сертифицирована по Международному стандарту ISO 9001;
- Лицензия ФСБ на осуществление работ с использованием сведений, составляющих государственную тайну;
- Поставка специализированных компонентов (Xilinx, Altera, Analog Devices, Intersil, Interpoint, Microsemi, Aeroflex, Peregrine, Syfer, Eurofarad, Texas Instrument, Miteq, Cobham, E2V, MA-COM, Hittite, Mini-Circuits, General Dynamics и др.);

Помимо этого, одним из направлений компании «ЭлектроПласт» является направление «Источники питания». Мы предлагаем Вам помощь Конструкторского отдела:

- Подбор оптимального решения, техническое обоснование при выборе компонента;
- Подбор аналогов;
- Консультации по применению компонента;
- Поставка образцов и прототипов;
- Техническая поддержка проекта;
- Защита от снятия компонента с производства.



#### Как с нами связаться

**Телефон:** 8 (812) 309 58 32 (многоканальный)

**Факс:** 8 (812) 320-02-42

**Электронная почта:** [org@eplast1.ru](mailto:org@eplast1.ru)

**Адрес:** 198099, г. Санкт-Петербург, ул. Калинина, дом 2, корпус 4, литера А.