

SIEMENS

RT series

Miniature Printed Circuit Board Relays, Sockets and Accessories

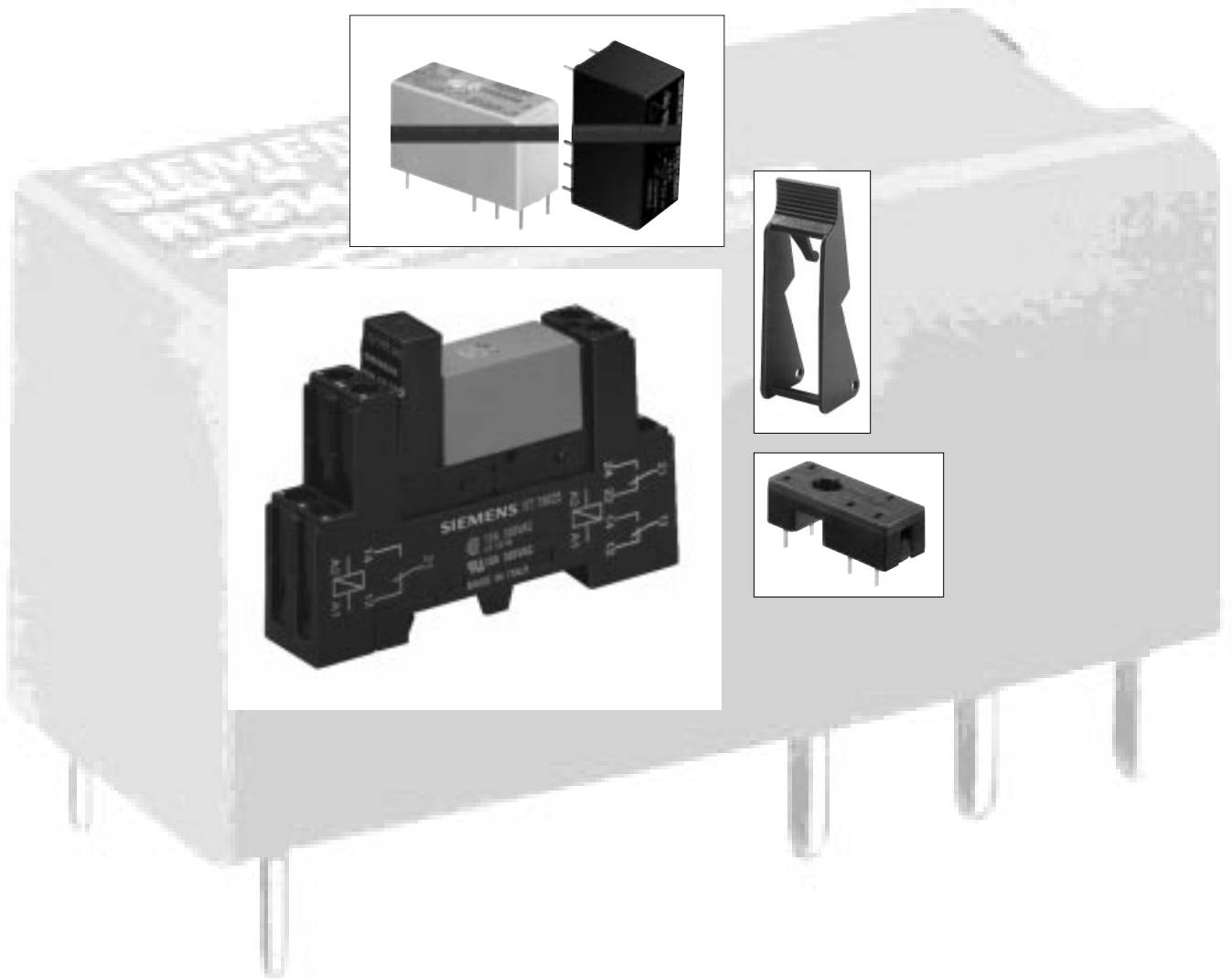

Siemens Electromechanical Components



RT series (DC Coil)

16 Amp PC Board Miniature Relay

Meets VDE 10mm Spacing, 5kV Dielectric

⚡ File E22575

Ⓢ File LR15734

⚙ NR 6106

Features

- SPST through DPDT contact arrangements.
- Immersion cleanable and flux tight versions available.
- VDE 10mm spacing, 5kV dielectric, coil to contacts.
- UL Class F coil insulation system.
- Conforms to UL 508, 1873, 353 and 1950.
- Low profile; 15.7mm height.
- Sensitive coil; 400mW.
- Withstand surge voltage of 10,000V.

Contact Data

Arrangements: 1 Form A (SPST-NO) Wiring Diagram Code 1, 3.
2 Form A (DPST-NO) Wiring Diagram Code 5.
1 Form C (SPDT) Wiring Diagram Code 1, 3.
2 Form C (DPDT) Wiring Diagram Code 5.

Material: Silver-nickel 90/10.

Minimum Load: 12V/100mA.

Expected Mechanical Life: 10 million operations.

Initial Contact Resistance: 100 milliohms max @ 1A 12VDC.

Designed to meet UL/CSA/VDE ratings with relay properly vented. Remove vent nib after soldering and cleaning.

UL/CSA/VDE Ratings @ 25°C

Code	NO/NC Load	Type	Operations
1	10A/10A @ 277VAC	Resistive/GP	100K
	10A/10A @ 30VDC	Resistive	100K
	12A/12A @ 250VAC	Resistive/GP	30K
	12A/12A @ 30VDC	Resistive	30K
	3/4 HP @ 480VAC*	Motor	6K
	1/2 HP @ 240VAC*	Motor	6K
	1/3 HP @ 120VAC*	Motor	6K
	48 LRA/10 FLA @ 240VAC*	Motor	30K
	TV-3 @ 120VAC*	Tungsten	25K
	A300, 720VA @ 240VAC*	Pilot Duty	30K
	3	16A/16A @ 250VAC	Resistive/GP
20A/20A @ 277VAC		Resistive/GP	30K
20A/20A @ 24VDC		Resistive	30K
16A/16A @ 30VDC		Resistive	30K
1 HP @ 480VAC*		Motor	6K
1 HP @ 240VAC*		Motor	6K
1/2 HP @ 120VAC*		Motor	6K
60 LRA/10 FLA @ 250VAC*		Motor	30K
TV-5 @ 120VAC*		Tungsten	25K
A300, 720VA @ 240VAC*		Pilot Duty	30K
B300, 360VA @ 240VAC**		Pilot Duty	30K
5	8A/8A @ 277VAC	Resistive/GP	100K
	8A/8A @ 30VDC	Resistive	100K
	10A/10A @ 250VAC	Resistive/GP	30K
	10A/10A @ 30VDC	Resistive	30K
	1/2 HP @ 240VAC*	Motor	6K
	1/4 HP @ 120VAC*	Motor	6K
	34.8 LRA/6 FLA @ 120VAC*	Motor	30K
	17.4 LRA/5 FLA @ 240VAC*	Motor	30K
	B300, 360VA @ 240VAC*	Pilot Duty	30K
	TV-3 @ 120VAC*	Tungsten	25K

* Form A only

** Form B only

Initial Dielectric Strength

Between Open Contacts: >1,000VAC (1 minute).

Between Poles (code 5): >2,500VAC (1 minute).

Between Coil and Contacts: >5,000VAC (1 minute).

Surge Voltage (DC): >10,000VAC x (1.2 x 50 μsec).

Coil Data @ 25°C

Voltage: 5 to 48VDC.

Nominal Power @ 25°C: 400mW.

Duty Cycle: Continuous.

Initial Insulation Resistance: 10,000 megohms, min., at 25°C, 500VDC and 50% rel. humidity.

Coil Data @ 25°C

Nominal Voltage VAC	DC Resistance in Ohms ±10%	Must Operate Voltage VAC	Nominal Coil Current (mA) – 50/60Hz.
005	62	3.5	80
006	90	4.2	66.7
009	202	6.3	44.4
012	360	8.4	33.3
018	810	12.6	22.2
024	1,440	16.8	16.7
048	5,760	33.6	8.3

Max. Ambient Temp. vs. Coil Voltage

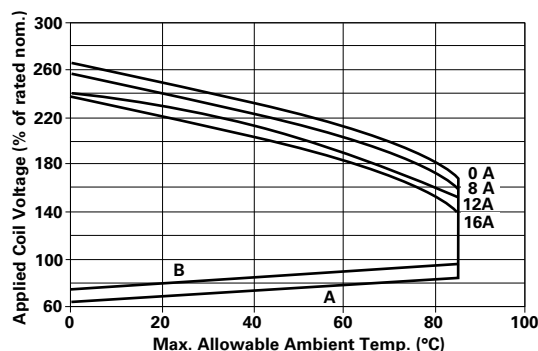

A: Coil temperature = Ambient temperature.

B: 110% of nominal coil voltage at rated contact load.

Operate Data @ 25°C

Must Operate Voltage(DC): 70% of nominal.

Must Release Voltage(DC): 10% of nominal.

Operate Time (Excluding Bounce):

7 ms, typ., 15ms max. at nom. voltage.

Release Time (Excluding Bounce):

3 ms, typ., 6ms max. at nom. voltage.

Environmental Data

Temperature Range:

Storage: -40°C to +105°C.

Operating: -40°C to +85°C at rated current.

Vibration, Operational

N.O.:0.065" (1.65mm) max. excursions from 10 - 55 Hz:

N.C.:0.032" (0.82mm) max. excursions from 10 - 55 Hz:

with no contact opening >10μs

Mechanical Data

Termination: Printed circuit terminals.

Enclosures: RT 1, 3, 4: Flux-tight, top vented, plastic case.

RT B, D, E: Immersion cleanable, plastic case.

Weight: 0.35 oz. (10g) approximately.

Ordering Information

Typical Part Number ▶	RT	1	3	4	012
<p>1. Basic Series: RT = Miniature, printed circuit board relay.</p> <p>2. Enclosure: 1 = 1 pole 12A, Pinning 3.5mm, flux-tight (Code 1). B = 1 pole 12A, Pinning 3.5mm, sealed (Code 1). 3 = 1 pole 16A, Pinning 5mm, flux-tight (Code 3). D = 1 pole 16A, Pinning 5mm, sealed (Code 3). 4 = 2 pole 8A, Pinning 5mm, flux-tight (Code 5). E = 2 pole 8A, Pinning 5mm, sealed (Code 5).</p> <p>3. Contact Arrangement: 1 = 1 Form C (SPST) (Requires wiring diagram codes 1 or 3.) 2 = 2 Form C (DPST) (Requires wiring diagram code 5.) 3 = 1 Form A (SPST-NO) (Requires wiring diagram codes 1 or 3.) 4 = 2 Form A (DPST-NO) (Requires wiring diagram code 5.)</p> <p>4. Contact Material: 4 = Silver-nickel 90/10 (standard stock). 1 = Silver cadmium Oxide (Special order)</p> <p>5. Coil Voltage: 005 = 5VDC 009 = 9VDC 018 = 18VDC 048 = 48VDC 006 = 6VDC 012 = 12VDC 024 = 24VDC</p>					

Stock Items

RT114012	RT134024	RTB14024	RT314012	RTD14005	RTD34012	RT424024	RTE24005	RTE44012
RT114024	RTB14005	RTB34012	RT314024	RTD14012	RTD34024	RT444012	RTE24012	RTE44024
RT134012	RTB14012	RTB34024	RT334012	RTD14024	RT424012	RT444024	RTE24024	

Outline Dimensions

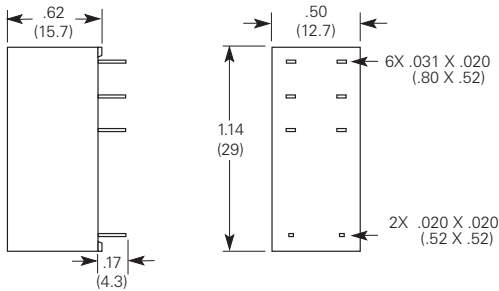

Breaking Capacity

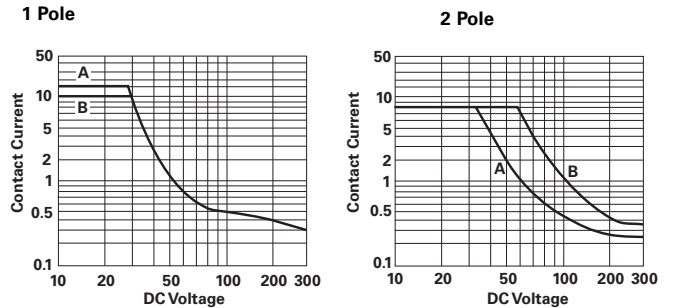

A: 16A Version.
B: 12A Version.

A: 1 Contact.
B: 2 Contacts in series.

PC Board Layouts (Bottom View)

**1 Pole 12A
3.5mm**

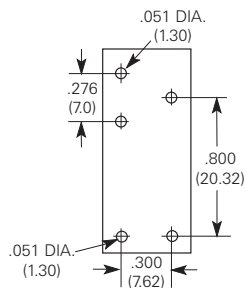

Code 1

**1 Pole 16A
2 Pole 8A
5mm**

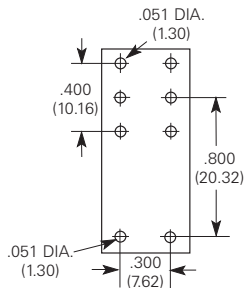

Code 3 & 5

Note: On single throw models, only necessary terminals are present.

Contact Life for Resistive AC Load (Typical)

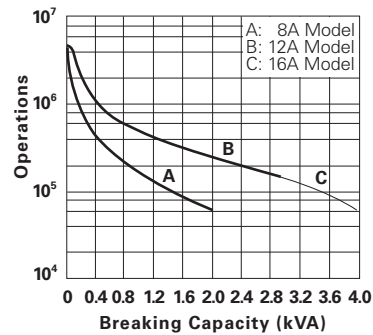

Note: Data from 250VAC @ 70°C.

Wiring Diagrams (Bottom View)

1 Pole 12A

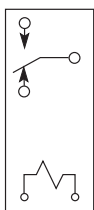

Code 1

1 Pole 16A

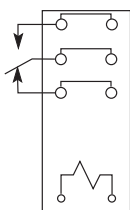

Code 3

2 Pole 8A

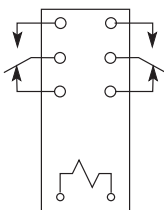

Code 5

Note: On single throw models, only necessary terminals are present.



RT series (AC Coil)

16 Amp Miniature Printed Circuit Board Relay

Meets VDE 10mm Spacing, 5kV Dielectric

File E38891

File LR14385

NR 6106

Features

- SPST through DPDT contact arrangements.
- Immersion cleanable and flux tight versions available.
- Meets VDE 10mm spacing, 5kV dielectric, coil to contacts.
- Conforms to UL 508, 1873 and 353.

Contact Data

Arrangements: 1 Form A (SPST-NO) Wiring Diagram Code 1, 3.
2 Form A (DPST-NO) Wiring Diagram Code 5.
1 Form C (SPDT) Wiring Diagram Code 1, 3.
2 Form C (DPDT) Wiring Diagram Code 5.

Material: Silver-nickel 90/10.

Minimum Load: 12V/100mA.

Expected Mechanical Life: 10 million operations.

Designed to meet UL/CSA/VDE ratings with relay properly vented. Remove vent nib after soldering and cleaning.

UL/CSA Ratings @ 25°C:

Code	NO/NC Load	Type	Operations
1	12A NO @ 240VAC	GP	30K
	10A/5A @ 240VAC	Resistive/GP	100K
	8A @ 28VDC	Resistive	30K
	1 HP @ 240VAC*	Motor	6K
	1/2 HP @ 120VAC*	Motor	6K
	8A @ 28VDC*	Resistive	30K
3	16A/8A @ 240VAC	GP	6K
	8A @ 28VDC	Resistive	30K
	1/2 HP @ 120VAC*	Motor	6K
	1HP @ 240VAC*	Motor	6K
	48 LRA, 8 FLA @ 240VAC	Motor	30K
	B300	Pilot Duty	6K
5	8A @ 240VAC	Resistive	30K
	8A @ 28VDC	Resistive/GP	30K
	1/2 HP @ 240VAC	Motor	6K
	1/4 HP @ 120VAC	Motor	6K
	B300	Pilot Duty	6K

* Form A only

VDE Ratings @ 25°C:

Code	NO/NC Load	Type	Operations
1	12A @ 250VAC	Resistive	30K
	12A @ 250VAC	Resistive	100K
3	16A @ 250VAC	Resistive	10K
	16A @ 250VAC	Resistive	50K
5	8A @ 250VAC	Resistive	30K
	8A @ 250VAC	Resistive	50K

Initial Dielectric Strength

Between Open Contacts: >1,000VAC (1 minute).

Between Poles (code 5): >2,500VAC (1 minute).

Between Coil and Contacts: >5,000VAC (1 minute).

Creepage/Clearance, Coil to Contact: 10/10mm.

Coil Data @ 20°C

Voltage: 24, 115, 230VAC.

Nominal Power @ 25°C: .75VA.

Duty Cycle: Continuous.

Initial Insulation Resistance: 10,000 megohms, min., at 20°C, 500VDC and 50% rel. humidity..

Coil Data

Nominal Voltage VAC	DC Resistance in Ohms ±10%	Must Operate Voltage VAC	Drop-out Voltage VAC	Nominal Coil Current (mA)–50Hz.	Nominal Coil Current (mA)–60Hz.
24	350	18.0	3.6	31.6	24.3
115	8,100	86.3	17.3	6.6	5.1
230	32,500	172.5	34.5	3.3	2.3

Max. Ambient Temp. vs. Coil Voltage

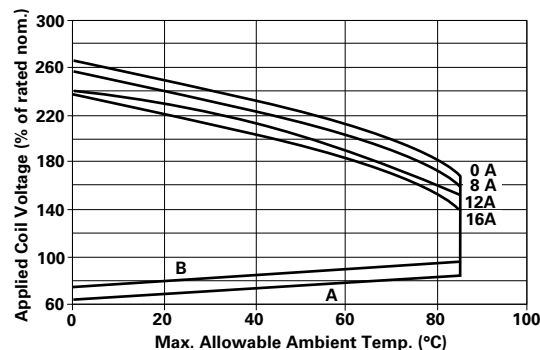

A: Coil temperature = Ambient temperature.

B: 110% of nominal coil voltage at rated contact load.

Operate Data

Must Operate Voltage: See coil data.

Operate Time (Excluding Bounce): 8 ms, typ., at nom. voltage.

Release Time (Excluding Bounce): 11 ms, typ., at nom. voltage.

Environmental Data

Temperature Range:

Storage: -40°C to +105°C.

Operating: -40°C to +70°C at rated current.

Vibration: 30 - 150 Hz:

at 20g with no contact opening >10μs on the N.O. contact;
at 5g with no contact opening >10μs on the N.C. contact.

Mechanical Data

Termination: Printed circuit terminals.

Enclosures: RT 1, 3, 4: Flux-tight, top vented, plastic case.

RT B, D, E: Immersion cleanable, plastic case.

Weight: 0.42 oz. (12g) approximately.

Ordering Information

Typical Part Number ▶	RT	D	1	4	524
<p>1. Basic Series: RT = Miniature, printed circuit board relay.</p> <p>2. Enclosure: 1 = 1 pole 12A, Pinning 3.5mm, flux-tight (Code 1). B = 1 pole 12A, Pinning 3.5mm, sealed (Code 1). 3 = 1 pole 16A, Pinning 5mm, flux-tight (Code 3). D = 1 pole 16A, Pinning 5mm, sealed (Code 3). 4 = 2 pole 8A, Pinning 5mm, flux-tight (Code 5). E = 2 pole 8A, Pinning 5mm, sealed (Code 5).</p> <p>3. Contact Arrangement: 1 = 1 Form C (SPST) (Requires wiring diagram codes 1 or 3.) 2 = 2 Form C (DPST) (Requires wiring diagram code 5.) 3 = 1 Form A (SPST-NO) (Requires wiring diagram codes 1 or 3.) 4 = 2 Form A (DPST-NO) (Requires wiring diagram code 5.)</p> <p>4. Contact Material: 4 = Silver-nickel 90/10.</p> <p>5. Coil Voltage: 524 = 24VAC 730 = 230VAC 615 = 115VAC</p>					

Stock Items

RTB14524	RTD14524	RTE24524
RTB14615	RTD14615	RTE24615
RTB14730	RTD14730	RTE24730

Outline Dimensions

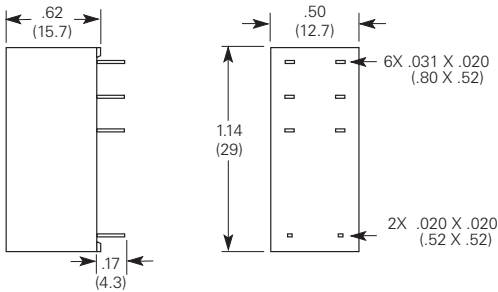

PC Board Layouts (Bottom View)

1 Pole 12A
3.5mm

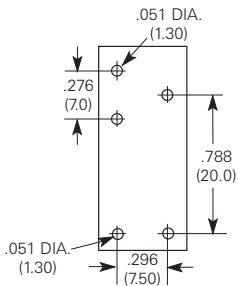

Code 1

1 Pole 16A
2 Pole 8A
5mm

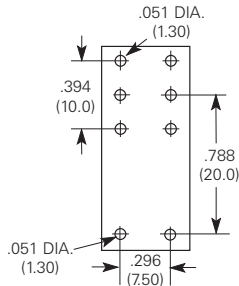

Code 3 & 5

Note: On single throw models, only necessary terminals are present.

Wiring Diagrams (Bottom View)

1 Pole 12A

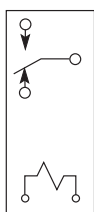

Code 1

1 Pole 16A

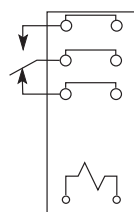

Code 3

2 Pole 8A

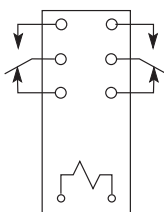

Code 5

Note: On single throw models, only necessary terminals are present.

Breaking Capacity

1 Pole

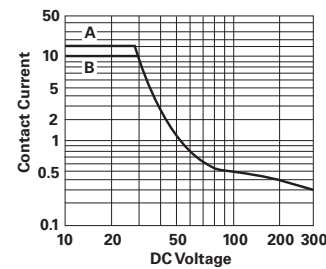

2 Pole

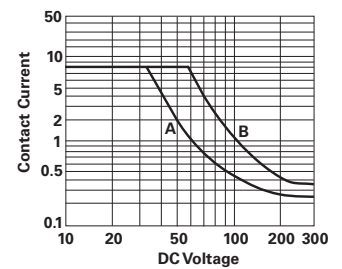

A: 16A Version.
B: 12A Version.

A: 1 Contact.
B: 2 Contacts in series.

Contact Life for Resistive AC Load (Typical)

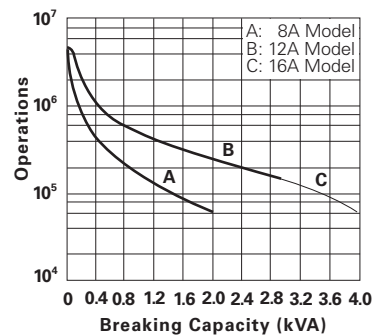

Note: Data from 250VAC @ 70°C.



RT series (Latching)

16 Amp Miniature Printed Circuit Board Relay

Meets VDE 10mm Spacing, 5KV Dielectric

File E38891

File LR14385

NR 6106

Features

- Latching relay with 1 or 2 coils.
- SPDT (16A) and DPDT (8A) contact arrangements.
- Flux tight enclosure.
- Meets VDE 10mm spacing, 5kV dielectric, coil to contacts.
- Conforms to UL 508, 1873 and 353.

Contact Data

Arrangements: 1 Form C (SPDT) Wiring Diagram Code 3.
2 Form C (DPDT) Wiring Diagram Code 5.

Material: Silver-nickel 90/10.

Minimum Load: 12V/100mA.

Expected Mechanical Life: 5 million operations, 1 pole.
2 million operations, 2 pole.

Designed to meet UL/CSA/VDE ratings with relay properly vented. Remove vent nib after soldering and cleaning.

UL/CSA ratings @ 70°C:

Code	NO/NC Load	Type	Operations
3	16A/8A @ 240VAC	GP	6K
	8A @ 28VDC	Resistive	30K
	1/2 HP @ 120VAC*	Motor	6K
	1HP @ 240VAC*	Motor	6K
	48 LRA, 8 FLA @ 240VAC B300	Motor Pilot Duty	30K 6K
5	8A @ 240VAC	Resistive	30K
	8A @ 28VDC	Resistive/GP	30K
	1/2 HP @ 240VAC	Motor	6K
	1/4 HP @ 120VAC	Motor	6K
	B300	Pilot Duty	6K

* Form A only

VDE Ratings @ 70°C:

Code	NO/NC Load	Type	Operations
3	16A @ 250VAC	Resistive	10K
	8A @ 250VAC	Resistive	30K
5	8A @ 250VAC	Resistive	30K
	8A @ 250VAC	Resistive	100K

Initial Dielectric Strength

Between Open Contacts: >1,000VAC (1 minute).

Between Poles (code 5): >2,500VAC (1 minute).

Between Coil and Contacts: >5,000VAC (1 minute).

Creepage/Clearance, Coil to Contact: 10/10mm.

Coil Data @ 20°C

Voltage: 5 to 24VDC*, 1 coil.
3 to 24VDC*, 2 coil.

Nominal Power @ 25°C: 400mW, 1 coil.
600mW, 2 coil.

Duty Cycle: Continuous.

Initial Insulation Resistance: 10,000 megohms, min., at 20°C, 500VDC and 50% rel. humidity.

* Other coil voltages upon request.

1 Coil Data

Nominal Voltage VDC	DC Resistance in Ohms ±10%	Set Voltage VDC	Reset Voltage VDC	Nominal Coil Current (mA)
05	62	3.5–6.0	2.75–6.0	80.0
06	90	4.2–7.2	3.30–7.2	66.7
12	360	8.4–14.4	6.60–14.4	33.3
24	1,440	16.8–28.8	13.20–28.8	16.7

2 Coil Data

Nominal Voltage VDC	DC Resistance in Ohms ±10%	Set Voltage VDC	Reset Voltage VDC	Nominal Coil Current (mA)
05	42	3.5–7.5	2.75–4.5	120.0
06	55	4.2–9.0	3.30–9.0	108.0
12	240	8.4–18.0	6.60–18.0	50.0
24	886	16.8–36.0	13.20–36.0	27.0

Operate Data @ 20°C

Must Operate Voltage: See coil data.

Operate Time (Excluding Bounce): 5 ms, typ., at nom. voltage.

Release Time (Excluding Bounce): 4 ms, typ., at nom. voltage.

Max. Switching Rate: 360 ops. at rated load.

Environmental Data

Temperature Range:

Storage: -40°C to +105°C.

Operating: -40°C to +70°C at rated current.

Vibration: 30 - 500 Hz:

N/C opens at >3g and changes from reset to set at >5g;

Shock: N/C opens at >6g and changes from reset to set at >15g.;

Mechanical Data

Termination: Printed circuit terminals.

Enclosures: RT 3, 4: Flux-tight, top vented, plastic case.

Weight: 0.46 oz. (13g) approximately.

Ordering Information

Typical Part Number ▶

RT

3

2

4

A05

1. Basic Series:

RT = Miniature, printed circuit board relay.

2. Enclosure:

3 = 1 pole 16A, Pinning 5mm, flux-tight (Code 3).
 4 = 2 pole 8A, Pinning 5mm, flux-tight (Code 5).

3. Contact Arrangement:

1 = 1 Form C (SPDT) (Requires wiring diagram code 3.)
 2 = 2 Form C (DPDT) (Requires wiring diagram code 5.)

4. Contact Material:

4 = Silver-nickel 90/10.

5. Coil Voltage:

1 Coil	2 Coil	Voltage
A05	F05	= 5VDC
A06	F06	= 6VDC
A12	F12	= 12VDC
A24	F24	= 24VDC

Stock Items

Consult factory for availability.

Outline Dimensions

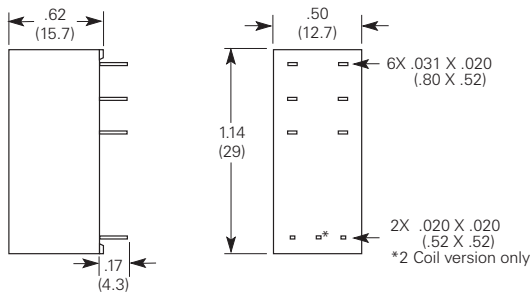

Wiring Diagrams (Bottom View)

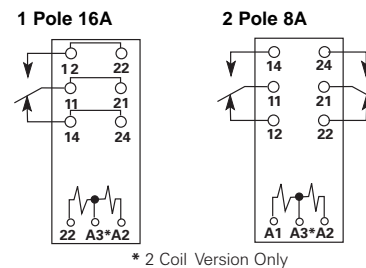

Code 3

Code 5

PC Board Layout (Bottom View)

1 Pole 16A
 2 Pole 8A
 5mm

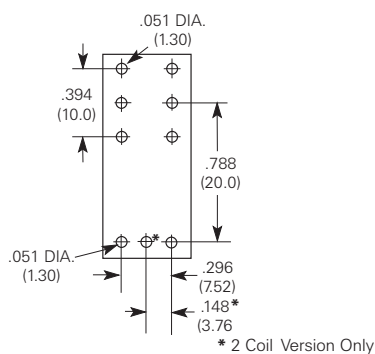

Code 3 & 5

Breaking Capacity

1 Pole

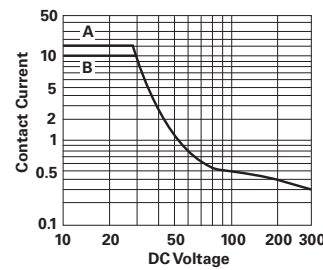

A: 16A Version.
 B: 12A Version.

2 Pole

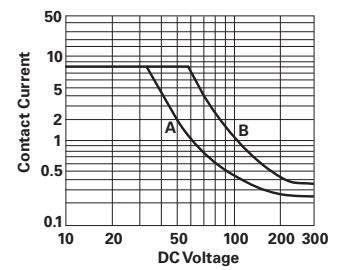

A: 1 Contact.
 B: 2 Contacts in series.

RT series

Sockets and Accessories

File E135149

File LR14385

NR 5318



RT78625 with RPMU0730



RP78601



RT16016

Sockets for RT Series Relays

RT78624¹
10A, 300VAC
5mm Pinning

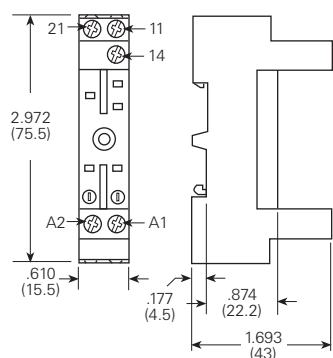

Hold-Down Spring RT16016

RT78625^{1,2}
1 Pole 10A, 250VAC
2 Pole 2x 10A, 250VAC
5mm Pinning

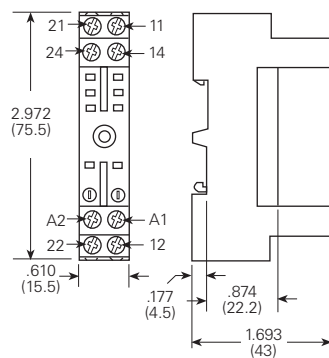

Hold-Down Spring RT16016

RT78626^{1,2}
1 Pole 12A, 300VAC
2 Pole 2x 12A, 300VAC
5mm Pinning

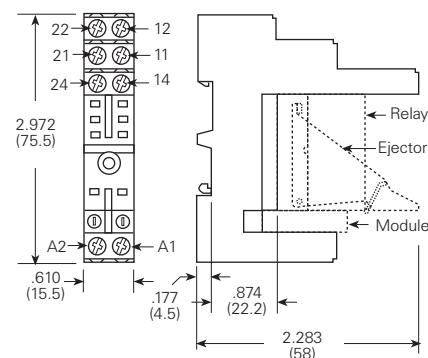

Ejector/Hold-Down Spring RT16016³

RP78601¹
10A, 250VAC
3.5mm Pinning

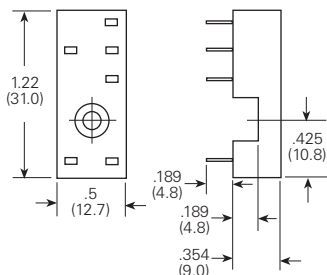

Hold-Down Spring RP16041

PC Board Layout
(Bottom View)

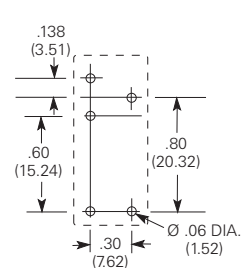

RP78602¹
1 Pole 10A, 250VAC
2 Pole 2x 10A, 250VAC
5mm Pinning

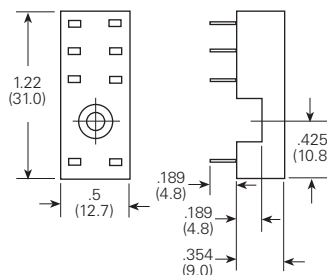

Hold-Down Spring RP16041

PC Board Layout
(Bottom View)

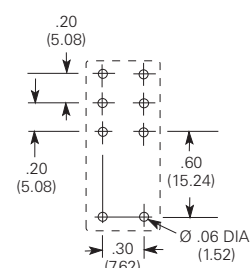

Socket and Accessory Selection Table

Stock items are boldfaced.

Socket	Socket Termination	Hold-Down Spring
RT78624^{1,2}	DIN Screw Terminal	RT16016
RT78625^{1,2}	DIN Screw Terminal	RT16016
RT78626¹	DIN Screw Terminal	RT16016
RP78601 ¹	PCB	RP16041
RP78602 ¹	PCB	RP16041
RPMU0730	RC Network 110..230VAC	-

* Note

- Not suitable for bistable relay with two coils.
- For a 16A 1 pole relay the following jumpers have to be connected; 11 to 21, 12 to 22 and 14 to 24.
- Insertion of the relay.
First the ejector (and eventually the module) has to be mounted onto the socket. Then the relay has to be set in the correct position and pressed into the socket until the ejector snaps over the top of the relay.



Компания «ЭлектроПласт» предлагает заключение долгосрочных отношений при поставках импортных электронных компонентов на взаимовыгодных условиях!

Наши преимущества:

- Оперативные поставки широкого спектра электронных компонентов отечественного и импортного производства напрямую от производителей и с крупнейших мировых складов;
- Поставка более 17-ти миллионов наименований электронных компонентов;
- Поставка сложных, дефицитных, либо снятых с производства позиций;
- Оперативные сроки поставки под заказ (от 5 рабочих дней);
- Экспресс доставка в любую точку России;
- Техническая поддержка проекта, помощь в подборе аналогов, поставка прототипов;
- Система менеджмента качества сертифицирована по Международному стандарту ISO 9001;
- Лицензия ФСБ на осуществление работ с использованием сведений, составляющих государственную тайну;
- Поставка специализированных компонентов (Xilinx, Altera, Analog Devices, Intersil, Interpoint, Microsemi, Aeroflex, Peregrine, Syfer, Eurofarad, Texas Instrument, Miteq, Cobham, E2V, MA-COM, Hittite, Mini-Circuits, General Dynamics и др.);

Помимо этого, одним из направлений компании «ЭлектроПласт» является направление «Источники питания». Мы предлагаем Вам помощь Конструкторского отдела:

- Подбор оптимального решения, техническое обоснование при выборе компонента;
- Подбор аналогов;
- Консультации по применению компонента;
- Поставка образцов и прототипов;
- Техническая поддержка проекта;
- Защита от снятия компонента с производства.



Как с нами связаться

Телефон: 8 (812) 309 58 32 (многоканальный)

Факс: 8 (812) 320-02-42

Электронная почта: org@eplast1.ru

Адрес: 198099, г. Санкт-Петербург, ул. Калинина, дом 2, корпус 4, литера А.