

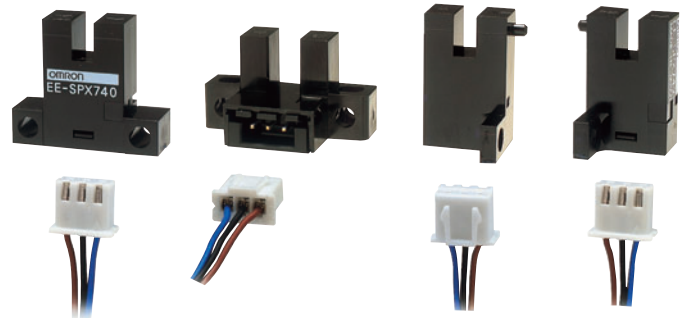

# EE-SPX74/84

**Photomicrosensor with light modulation for reduced external light interference and a connector for easy maintenance.**

- Built-in connectors
- Select from four easy-to-use shapes for efficient space utilization.
- Connectors with locks for safety against vibration.
- Convenient mounting method using M3 screws.
- Wide operating voltage range: 5 to 24 VDC









 Be sure to read *Safety Precautions* on page 4.

## Ordering Information

### Sensors

 Infrared light

| Appearance  | Sensing method                | Sensing distance  |  | Output type | Output configuration | Model     |
|---|-------------------------------|---|--|-------------|----------------------|-----------|
|  | Through-beam type (with slot) |  3.6 mm (slot width) |  | NPN output  | Dark-ON              | EE-SPX740 |
|   |                               |   |  |             | Light-ON             | EE-SPX840 |
|  |                               |   |  |             | Dark-ON              | EE-SPX742 |
|   |                               |   |  |             | Light-ON             | EE-SPX842 |
|  |                               |  5 mm (slot width)   |  |             | Dark-ON              | EE-SPX743 |
|   |                               |   |  |             | Light-ON             | EE-SPX843 |
|  |                               |   |  |             | Dark-ON              | EE-SPX741 |
|   |                               |   |  |             | Light-ON             | EE-SPX841 |

### Accessories (Order Separately)

#### Connector with Cable

| Type      | Cable length | Model   |
|-----------|--------------|---------|
| Connector | 1 m          | EE-1013 |

\* Refer to *Accessories* for details.

## Ratings and Specifications

| Item                             | Models        | EE-SPX740, EE-SPX840<br>EE-SPX742, EE-SPX842<br>EE-SPX743, EE-SPX843  | EE-SPX741<br>EE-SPX841  |
|----------------------------------|---------------|---|-------------------------|
| <b>Sensing distance</b>          |               | 3.6 mm (slot width)   | 5 mm (slot width)       |
| <b>Sensing object</b>            |               | Opaque: 1 × 0.5 mm min.   | Opaque: 2 × 0.8 mm min. |
| <b>Differential distance</b>     |               | 0.05 mm max.  |                         |
| <b>Light source</b>              |               | GaAs infrared LED (pulse lighting) with a peak wavelength of 940 nm   |                         |
| <b>Indicator *1</b>              |               | Light indicator (red)   |                         |
| <b>Supply voltage</b>            |               | 5 to 24 VDC ±10%, ripple (p-p): 5% max.   |                         |
| <b>Current consumption</b>       |               | Average: 15 mA max.; Peak: 50 mA max.   |                         |
| <b>Control output</b>            |               | NPN voltage output:<br>Load power supply voltage: 5 to 24 VDC<br>Load current: 50 mA max.<br>OFF current: 0.5 mA max.<br>50 mA load current with a residual voltage of 1.0 V max.<br>10 mA load current with a residual voltage of 0.4 V max. |                         |
| <b>Response frequency *2</b>     |               | 500 Hz min.   |                         |
| <b>Ambient illumination</b>      |               | 3,000 lx max. with incandescent light or sunlight on the surface of the receiver  |                         |
| <b>Ambient temperature range</b> |               | Operating: -10 to +55°C<br>Storage: -25 to +65°C  |                         |
| <b>Ambient humidity range</b>    |               | Operating: 5% to 85%<br>Storage: 5% to 95%  |                         |
| <b>Vibration resistance</b>      |               | Destruction: 10 to 55 Hz, 1.5-mm double amplitude for 2 h each in X, Y, and Z directions  |                         |
| <b>Shock resistance</b>          |               | Destruction: 500 m/s <sup>2</sup> for 3 times each in X, Y, and Z directions  |                         |
| <b>Degree of protection</b>      |               | IEC IP50  |                         |
| <b>Connecting method</b>         |               | Special connector   |                         |
| <b>Weight</b>                    |               | Approx. 2.4 g   |                         |
| <b>Material</b>                  | <b>Case</b>   | Polycarbonate   |                         |
|                                  | <b>Holder</b> |   |                         |

\*1. The indicator is a GaAlAs red LED (peak wavelength: 660 nm).  
\*2. The response frequency was measured by detecting the following rotating disk.

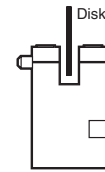
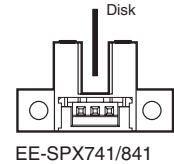
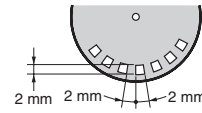

EE-SPX742/842  
EE-SPX743/843

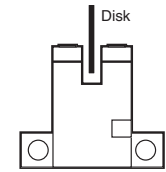

Engineering Data (Typical)

Sensing Position Characteristics

EE-SPX740/742/743

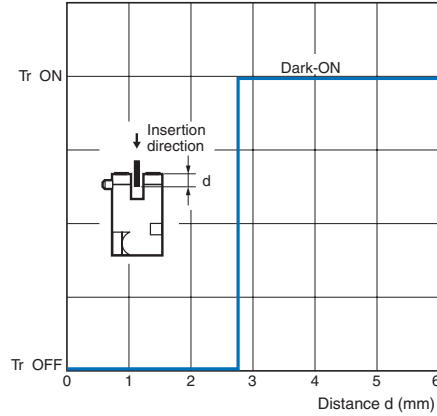
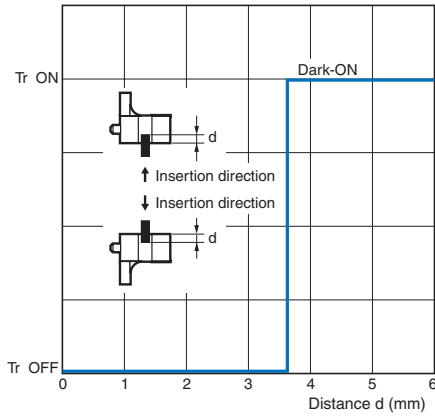

EE-SPX741

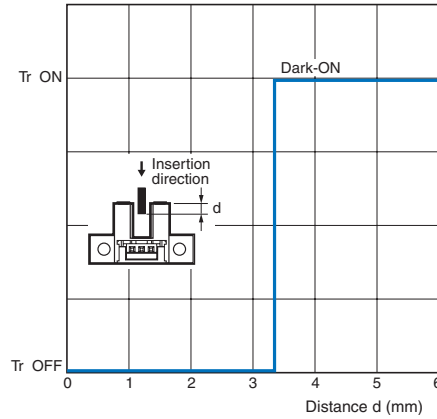
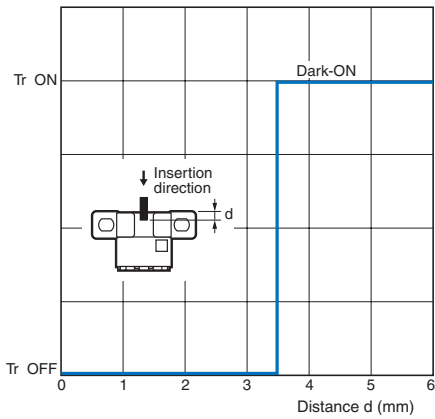

I/O Circuit Diagrams

NPN Output

| Model  | Output configuration | Timing charts | Output circuit |
|--|----------------------|---------------|----------------|
| EE-SPX740<br>EE-SPX741<br>EE-SPX742<br>EE-SPX743 | Dark-ON              |               |                |
| EE-SPX840<br>EE-SPX841<br>EE-SPX842<br>EE-SPX843 | Light-ON             |               |                |

Safety Precautions

Refer to *Warranty and Limitations of Liability*.

**WARNING**

This product is not designed or rated for ensuring safety of persons either directly or indirectly. Do not use it for such purposes.



**Precautions for Correct Use**

Make sure that this product is used within the rated ambient environment conditions.

● **Design**

**Cable Extension**

- When extending the cable, use an extension cable with conductors having a total cross-section area of 0.15 mm<sup>2</sup>. The total cable length must be 4 m maximum.
- To use a cable length longer than 4 m, attach a capacitor with a capacitance of approximately 10 μF to the wires as shown below. The distance between the terminal and the capacitor must be within 4 m. (Use a capacitor with a dielectric strength that is at least twice the Sensor's power supply voltage.)

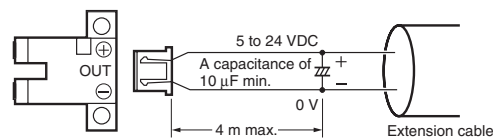

- Make sure the total length of the power cable connected to the product is less than 10 m even if a capacitor is inserted.

**Effects of Inductive Noise**

When there is inductive noise in the Sensor mounting frame (metal), the output of the Sensor may be affected. In this case, ensure that there is no electrical potential difference between the Sensor 0-V terminal and the Sensor mounting frame, or attach a 0.47 μF capacitor between the 0-V terminal and the frame.

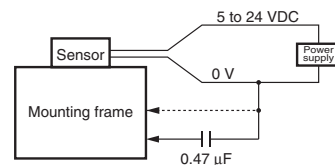

## Dimensions

Tolerance class IT16 applies to dimensions in this datasheet unless otherwise specified.

### Sensors

#### EE-SPX740 EE-SPX840

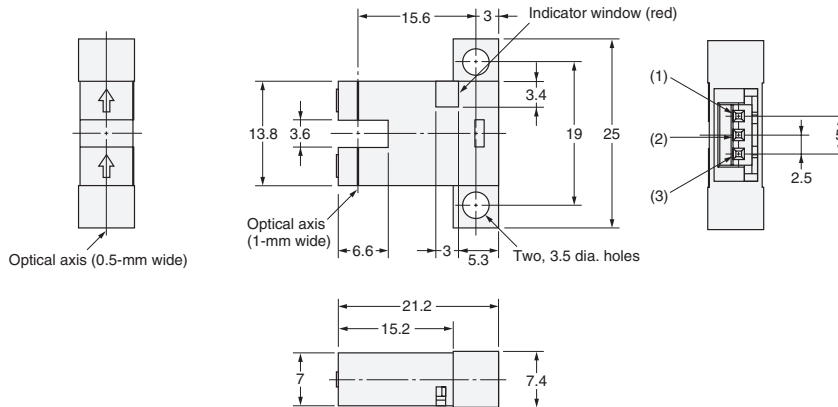

#### Terminal Arrangement

|     |     |          |
|-----|-----|----------|
| (1) | -   | GND(0 V) |
| (2) | OUT | OUTPUT   |
| (3) | +   | Vcc      |

#### EE-SPX742 EE-SPX842

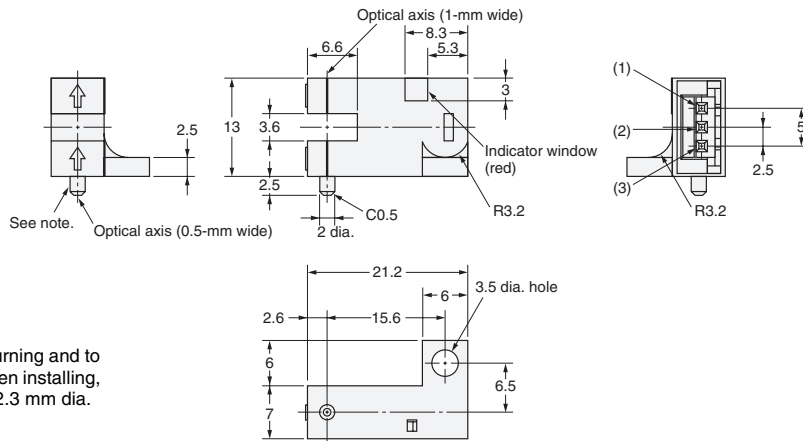

#### Terminal Arrangement

|     |     |          |
|-----|-----|----------|
| (1) | -   | GND(0 V) |
| (2) | OUT | OUTPUT   |
| (3) | +   | Vcc      |

Note: The lug is used to prevent turning and to indicate the optical axis. When installing, make a fixed hole of 2.1 to 2.3 mm dia.

#### EE-SPX743 EE-SPX843

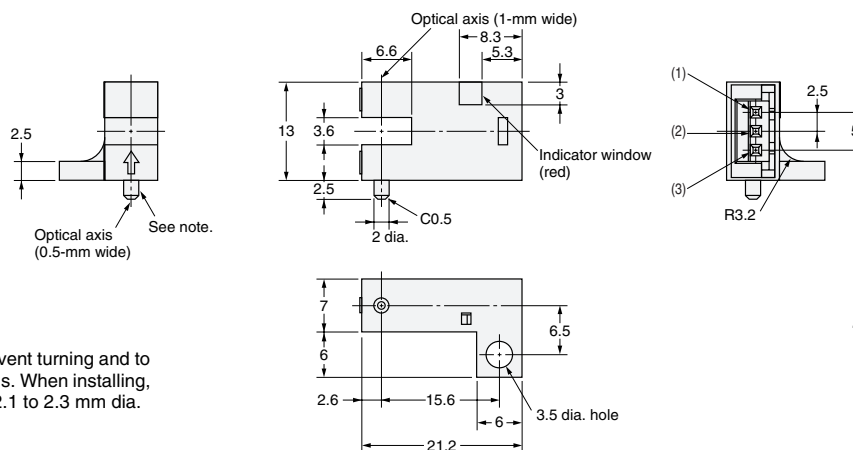

#### Terminal Arrangement

|     |     |          |
|-----|-----|----------|
| (1) | -   | GND(0 V) |
| (2) | OUT | OUTPUT   |
| (3) | +   | Vcc      |

Note: The lug is used to prevent turning and to indicate the optical axis. When installing, make a fixed hole of 2.1 to 2.3 mm dia.

## EE-SPX741 EE-SPX841

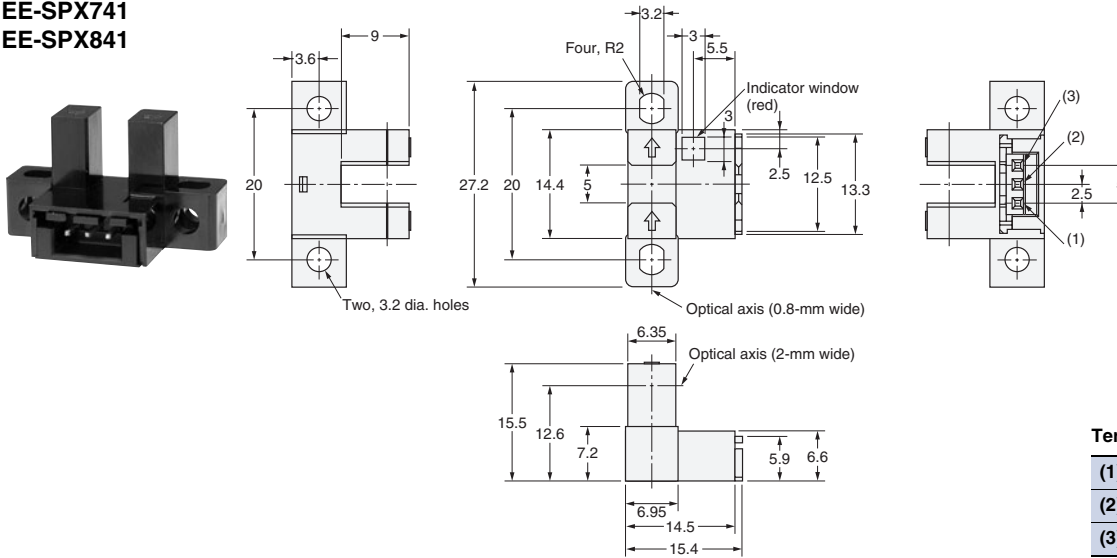

### Terminal Arrangement

|     |     |           |
|-----|-----|-----------|
| (1) | -   | GND (0 V) |
| (2) | OUT | OUTPUT    |
| (3) | +   | Vcc       |

## Accessories (Connector with Cable)

### EE-1013

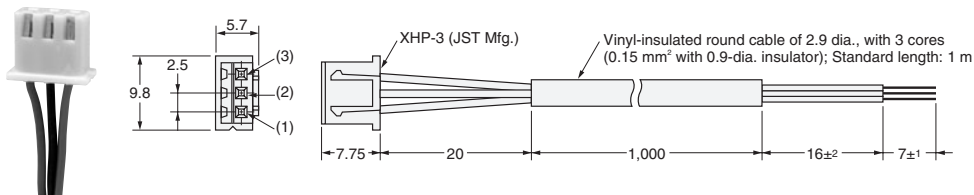

### Terminal Arrangement

|     |       |           |
|-----|-------|-----------|
| (1) | Blue  | GND (0 V) |
| (2) | Black | OUTPUT    |
| (3) | Brown | Vcc       |

## Read and Understand This Catalog

Please read and understand this catalog before purchasing the products. Please consult your OMRON representative if you have any questions or comments.

## Warranty and Limitations of Liability

### WARRANTY

OMRON's exclusive warranty is that the products are free from defects in materials and workmanship for a period of one year (or other period if specified) from date of sale by OMRON.

OMRON MAKES NO WARRANTY OR REPRESENTATION, EXPRESS OR IMPLIED, REGARDING NON-INFRINGEMENT, MERCHANTABILITY, OR FITNESS FOR PARTICULAR PURPOSE OF THE PRODUCTS. ANY BUYER OR USER ACKNOWLEDGES THAT THE BUYER OR USER ALONE HAS DETERMINED THAT THE PRODUCTS WILL SUITABLY MEET THE REQUIREMENTS OF THEIR INTENDED USE. OMRON DISCLAIMS ALL OTHER WARRANTIES, EXPRESS OR IMPLIED.

### LIMITATIONS OF LIABILITY

OMRON SHALL NOT BE RESPONSIBLE FOR SPECIAL, INDIRECT, OR CONSEQUENTIAL DAMAGES, LOSS OF PROFITS OR COMMERCIAL LOSS IN ANY WAY CONNECTED WITH THE PRODUCTS, WHETHER SUCH CLAIM IS BASED ON CONTRACT, WARRANTY, NEGLIGENCE, OR STRICT LIABILITY.

In no event shall the responsibility of OMRON for any act exceed the individual price of the product on which liability is asserted.

IN NO EVENT SHALL OMRON BE RESPONSIBLE FOR WARRANTY, REPAIR, OR OTHER CLAIMS REGARDING THE PRODUCTS UNLESS OMRON'S ANALYSIS CONFIRMS THAT THE PRODUCTS WERE PROPERLY HANDLED, STORED, INSTALLED, AND MAINTAINED AND NOT SUBJECT TO CONTAMINATION, ABUSE, MISUSE, OR INAPPROPRIATE MODIFICATION OR REPAIR.

## Application Considerations

### SUITABILITY FOR USE

OMRON shall not be responsible for conformity with any standards, codes, or regulations that apply to the combination of products in the customer's application or use of the products.

At the customer's request, OMRON will provide applicable third party certification documents identifying ratings and limitations of use that apply to the products. This information by itself is not sufficient for a complete determination of the suitability of the products in combination with the end product, machine, system, or other application or use.

The following are some examples of applications for which particular attention must be given. This is not intended to be an exhaustive list of all possible uses of the products, nor is it intended to imply that the uses listed may be suitable for the products:

- Outdoor use, uses involving potential chemical contamination or electrical interference, or conditions or uses not described in this catalog.
- Nuclear energy control systems, combustion systems, railroad systems, aviation systems, medical equipment, amusement machines, vehicles, safety equipment, and installations subject to separate industry or government regulations.
- Systems, machines, and equipment that could present a risk to life or property.

Please know and observe all prohibitions of use applicable to the products.

NEVER USE THE PRODUCTS FOR AN APPLICATION INVOLVING SERIOUS RISK TO LIFE OR PROPERTY WITHOUT ENSURING THAT THE SYSTEM AS A WHOLE HAS BEEN DESIGNED TO ADDRESS THE RISKS, AND THAT THE OMRON PRODUCTS ARE PROPERLY RATED AND INSTALLED FOR THE INTENDED USE WITHIN THE OVERALL EQUIPMENT OR SYSTEM.

### PROGRAMMABLE PRODUCTS

OMRON shall not be responsible for the user's programming of a programmable product, or any consequence thereof.

## Disclaimers

### CHANGE IN SPECIFICATIONS

Product specifications and accessories may be changed at any time based on improvements and other reasons.

It is our practice to change model numbers when published ratings or features are changed, or when significant construction changes are made. However, some specifications of the products may be changed without any notice. When in doubt, special model numbers may be assigned to fix or establish key specifications for your application on your request. Please consult with your OMRON representative at any time to confirm actual specifications of purchased products.

### DIMENSIONS AND WEIGHTS

Dimensions and weights are nominal and are not to be used for manufacturing purposes, even when tolerances are shown.

### PERFORMANCE DATA

Performance data given in this catalog is provided as a guide for the user in determining suitability and does not constitute a warranty. It may represent the result of OMRON's test conditions, and the users must correlate it to actual application requirements. Actual performance is subject to the OMRON Warranty and Limitations of Liability.

### ERRORS AND OMISSIONS

The information in this document has been carefully checked and is believed to be accurate; however, no responsibility is assumed for clerical, typographical, or proofreading errors, or omissions.

2010.8

In the interest of product improvement, specifications are subject to change without notice.

**OMRON Corporation**  
Industrial Automation Company

<http://www.ia.omron.com/>

(c)Copyright OMRON Corporation 2010 All Right Reserved.



Компания «ЭлектроПласт» предлагает заключение долгосрочных отношений при поставках импортных электронных компонентов на взаимовыгодных условиях!

Наши преимущества:

- Оперативные поставки широкого спектра электронных компонентов отечественного и импортного производства напрямую от производителей и с крупнейших мировых складов;
- Поставка более 17-ти миллионов наименований электронных компонентов;
- Поставка сложных, дефицитных, либо снятых с производства позиций;
- Оперативные сроки поставки под заказ (от 5 рабочих дней);
- Экспресс доставка в любую точку России;
- Техническая поддержка проекта, помощь в подборе аналогов, поставка прототипов;
- Система менеджмента качества сертифицирована по Международному стандарту ISO 9001;
- Лицензия ФСБ на осуществление работ с использованием сведений, составляющих государственную тайну;
- Поставка специализированных компонентов (Xilinx, Altera, Analog Devices, Intersil, Interpoint, Microsemi, Aeroflex, Peregrine, Syfer, Eurofarad, Texas Instrument, Miteq, Cobham, E2V, MA-COM, Hittite, Mini-Circuits, General Dynamics и др.);

Помимо этого, одним из направлений компании «ЭлектроПласт» является направление «Источники питания». Мы предлагаем Вам помощь Конструкторского отдела:

- Подбор оптимального решения, техническое обоснование при выборе компонента;
- Подбор аналогов;
- Консультации по применению компонента;
- Поставка образцов и прототипов;
- Техническая поддержка проекта;
- Защита от снятия компонента с производства.



#### Как с нами связаться

**Телефон:** 8 (812) 309 58 32 (многоканальный)

**Факс:** 8 (812) 320-02-42

**Электронная почта:** [org@eplast1.ru](mailto:org@eplast1.ru)

**Адрес:** 198099, г. Санкт-Петербург, ул. Калинина, дом 2, корпус 4, литера А.