

BGB707L7ESD

SiGe:C Wideband MMIC LNA with Integrated ESD Protection

Data Sheet

Revision 3.2, 2010-06-30

Edition 2010-06-30

**Published by
Infineon Technologies AG
81726 Munich, Germany**

**© 2010 Infineon Technologies AG
All Rights Reserved.**

Legal Disclaimer

The information given in this document shall in no event be regarded as a guarantee of conditions or characteristics. With respect to any examples or hints given herein, any typical values stated herein and/or any information regarding the application of the device, Infineon Technologies hereby disclaims any and all warranties and liabilities of any kind, including without limitation, warranties of non-infringement of intellectual property rights of any third party.

Information

For further information on technology, delivery terms and conditions and prices, please contact the nearest Infineon Technologies Office (www.infineon.com).

Warnings

Due to technical requirements, components may contain dangerous substances. For information on the types in question, please contact the nearest Infineon Technologies Office.

Infineon Technologies components may be used in life-support devices or systems only with the express written approval of Infineon Technologies, if a failure of such components can reasonably be expected to cause the failure of that life-support device or system or to affect the safety or effectiveness of that device or system. Life support devices or systems are intended to be implanted in the human body or to support and/or maintain and sustain and/or protect human life. If they fail, it is reasonable to assume that the health of the user or other persons may be endangered.

BGB707L7ESD SiGe:C Wideband MMIC LNA with Integrated ESD Protection
Revision History: 2010-06-30, Revision 3.2
Previous Revision: Revision 3.1

Page	Subjects (major changes since last revision)
	New template for data sheet layout.
18 - 26	Linearity description related to the RF output.
13, 14	Typical DC characteristic curves included.
27, 30	Typical AC characteristic curves included.
21, 24	AC performance tables expanded by 2 frequencies.

Trademarks of Infineon Technologies AG

BlueMoon™, COMNEON™, C166™, CROSSAVE™, CanPAK™, CIPOS™, CoolMOS™, CoolSET™, CORECONTROL™, DAVE™, EasyPIM™, EconoBRIDGE™, EconoDUAL™, EconoPACK™, EconoPIM™, EiceDRIVER™, EUPEC™, FCOS™, HITFET™, HybridPACK™, ISOFACE™, I²RF™, IsoPACK™, MIPAQ™, ModSTACK™, my-d™, NovalithIC™, OmniTune™, OptiMOS™, ORIGA™, PROFET™, PRO-SIL™, PRIMARION™, PrimePACK™, RASIC™, ReverSave™, SatRIC™, SensoNor™, SIEGET™, SINDRION™, SMARTi™, SmartLEWIS™, TEMPFET™, thinQ!™, TriCore™, TRENCHSTOP™, X-GOLD™, XMM™, X-PMU™, XPOSYS™.

Other Trademarks

Advance Design System™ (ADS) of Agilent Technologies, AMBA™, ARM™, MULTI-ICE™, PRIMECELL™, REALVIEW™, THUMB™ of ARM Limited, UK. AUTOSAR™ is licensed by AUTOSAR development partnership. Bluetooth™ of Bluetooth SIG Inc. CAT-iq™ of DECT Forum. COLOSSUS™, FirstGPS™ of Trimble Navigation Ltd. EMV™ of EMVCo, LLC (Visa Holdings Inc.). EPCOS™ of Epcos AG. FLEXGO™ of Microsoft Corporation. FlexRay™ is licensed by FlexRay Consortium. HYPERTERMINAL™ of Hilgraeve Incorporated. IEC™ of Commission Electrotechnique Internationale. IrDA™ of Infrared Data Association Corporation. ISO™ of INTERNATIONAL ORGANIZATION FOR STANDARDIZATION. MATLAB™ of MathWorks, Inc. MAXIM™ of Maxim Integrated Products, Inc. MICROTEC™, NUCLEUS™ of Mentor Graphics Corporation. Mifare™ of NXP. MIPI™ of MIPI Alliance, Inc. MIPS™ of MIPS Technologies, Inc., USA. muRata™ of MURATA MANUFACTURING CO., MICROWAVE OFFICE™ (MWO) of Applied Wave Research Inc., OmniVision™ of OmniVision Technologies, Inc. Openwave™ Openwave Systems Inc. RED HAT™ Red Hat, Inc. RFMD™ RF Micro Devices, Inc. SIRIUS™ of Sirius Sattelite Radio Inc. SOLARIS™ of Sun Microsystems, Inc. SPANSION™ of Spansion LLC Ltd. Symbian™ of Symbian Software Limited. TAIYO YUDEN™ of Taiyo Yuden Co. TEAKLITE™ of CEVA, Inc. TEKTRONIX™ of Tektronix Inc. TOKO™ of TOKO KABUSHIKI KAISHA TA. UNIX™ of X/Open Company Limited. VERILOG™, PALLADIUM™ of Cadence Design Systems, Inc. VLYNQ™ of Texas Instruments Incorporated. VXWORKS™, WIND RIVER™ of WIND RIVER SYSTEMS, INC. ZETEX™ of Diodes Zetex Limited.

Last Trademarks Update 2010-03-22

Table of Contents

	Table of Contents	4
	List of Figures	5
	List of Tables	6
1	Features	7
2	Product Brief	8
3	Maximum Ratings	10
4	Thermal Characteristics	11
5	Operation Conditions	12
6	Electrical Characteristics	12
6.1	DC Characteristics	12
6.2	Typical DC Characteristic Curves	13
6.3	AC Characteristics	15
6.3.1	AC Characteristics in FM Radio Applications	15
6.3.1.1	High-Ohmic FM Radio Antenna	15
6.3.1.2	50 Ω FM Radio Antenna	15
6.3.2	AC Characteristics in the SDMB Application	16
6.3.3	AC Characteristics in Test Fixture	17
6.3.4	Typical AC Characteristic Curves	27
7	Package Information	31

List of Figures

Figure 1	Pinning PG-TSLP-7-1	8
Figure 2	Function Block	9
Figure 3	Total Power Dissipation $P_{\text{tot}} = f(T_s)$	11
Figure 4	I_{CC} as a Function of R_{ext} , V_{CC} as Parameter	13
Figure 5	I_{CC} as a Function of V_{CC} , $V_{\text{Ctrl}} = 3 \text{ V}$, R_{ext} as Parameter	13
Figure 6	I_{CC} as a Function of V_{Ctrl} , $V_{\text{CC}} = 3 \text{ V}$, R_{ext} as Parameter	14
Figure 7	I_{CC} as a Function of Temperature, $V_{\text{Ctrl}} = V_{\text{CC}} = 3 \text{ V}$, $R_{\text{ext}} = \text{open}$	14
Figure 8	Testing Circuit for Frequencies from 150 MHz to 10 GHz	17
Figure 9	S_{11} as a Function of Frequency, I_C as Parameter	27
Figure 10	S_{22} as a Function of Frequency, I_C as Parameter	27
Figure 11	Transition Frequency as a Function of I_C , V_C as Parameter	28
Figure 12	Optimum Source Impedance for Minimum NF as a Function of Frequency, I_C as Parameter	28
Figure 13	Maximum Power Gain as a Function of I_C , Frequency as Parameter	29
Figure 14	Power Gain as a Function of I_C , Frequency as Parameter	29
Figure 15	Power Gain and Total Supply Current as a Function of RF Input Power at 3.5 GHz	30
Figure 16	Output 3 rd Order Intercept Point as a Function of I_C at 3.5 GHz, V_C as Parameter	30
Figure 17	Package Outline TSLP-7-1	31
Figure 18	Footprint	31
Figure 19	Marking Layout (top view)	31
Figure 20	Tape Dimensions	31

List of Tables

Table 1	Pinning Table	8
Table 2	Maximum Ratings at $T_A = 25^\circ\text{C}$ (unless otherwise specified)	10
Table 3	Thermal Resistance	11
Table 4	Operation Conditions	12
Table 5	DC Characteristics at $V_{CC} = 3\text{ V}$, $T_A = 25^\circ\text{C}$	12
Table 6	AC Characteristics in the FM Radio Application as Described in AN177	15
Table 7	AC Characteristics in the FM Radio Application as Described in AN181	15
Table 8	AC Characteristics in the SDMB Application as Described in TR122, $T_A = 25^\circ\text{C}$	16
Table 9	AC Characteristics $V_C = 3\text{ V}$, $f = 150\text{ MHz}$	18
Table 10	AC Characteristics $V_C = 3\text{ V}$, $f = 450\text{ MHz}$	19
Table 11	AC Characteristics $V_C = 3\text{ V}$, $f = 900\text{ MHz}$	20
Table 12	AC Characteristics $V_C = 3\text{ V}$, $f = 1.5\text{ GHz}$	21
Table 13	AC Characteristics $V_C = 3\text{ V}$, $f = 1.9\text{ GHz}$	22
Table 14	AC Characteristics $V_C = 3\text{ V}$, $f = 2.4\text{ GHz}$	23
Table 15	AC Characteristics $V_C = 3\text{ V}$, $f = 3.5\text{ GHz}$	24
Table 16	AC Characteristics $V_C = 3\text{ V}$, $f = 5.5\text{ GHz}$	25
Table 17	AC Characteristics $V_C = 3\text{ V}$, $f = 10\text{ GHz}$	26

1 Features

- High performance general purpose wideband MMIC LNA
- ESD protection integrated for all pins (3 kV for RF input vs. GND, 2 kV for all other pin combinations, HBM)
- Integrated active biasing circuit enables stable operation point against temperature- and processing-variations
- Excellent noise figure from Infineon’s reliable high volume SiGe:C technology
- High gain and linearity at low current consumption
- Operation voltage: 1.8 V to 4.0 V
- Adjustable operation current 2.1 mA to 25 mA by external resistor
- Power-off function
- Very small and leadless package TSLP-7-1, 2.0 x 1.3 x 0.4 mm³
- Pb-free (RoHS compliant) and halogen-free (WEEE compliant) package



Applications

As Low Noise Amplifier (LNA) in

- Mobile, portable and fixed connectivity applications: WLAN 802.11a/b/g/n, WiMax 2.5/3.5/5 GHz, UWB, WiFi, Bluetooth
- Satellite communication systems: Navigation systems (GPS, Glonass), satellite radio (SDARs, DAB) and C-band LNB
- Multimedia applications such as mobile/portable TV, CATV, FM Radio
- 3G/4G UMTS/LTE mobile phone applications
- ISM applications like RKE, AMR and Zigbee, as well as for emerging wireless applications

Attention: ESD (Electrostatic discharge) sensitive device, observe handling precautions

Product Name	Package	Marking
BGB707L7ESD	TSLP-7-1	AZ

2 Product Brief

The BGB707L7ESD is a Silicon Germanium Carbon (SiGe:C) low noise amplifier MMIC with integrated ESD protection and active biasing. The device is as flexible as a discrete transistor and features high gain, reduced power consumption and very low distortion for a very wide range of applications.

The device is based upon Infineon Technologies cost effective SiGe:C technology and comes in a low profile TSLP-7-1 leadless green package

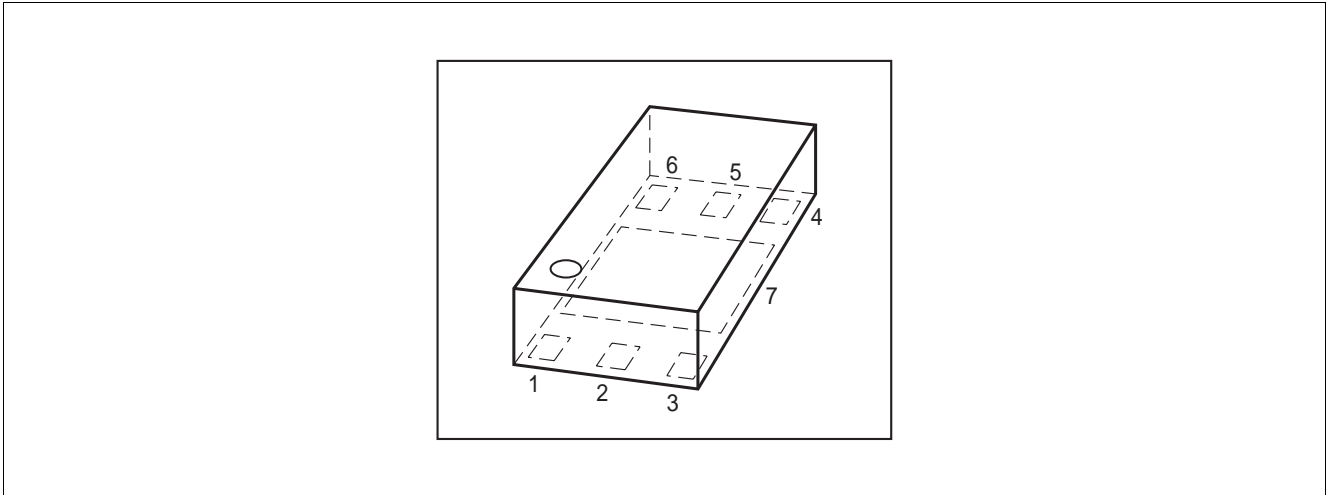

Figure 1 Pinning PG-TSLP-7-1

Table 1 Pinning Table

Pin	Name	Function
1	V_{CC}	Supply voltage
2	V_{Bias}	Bias reference voltage
3	RF_{in}	RF input
4	RF_{out}	RF output
5	V_{Ctrl}	On/Off control voltage
6	Adj	Current adjustment pin
7	GND	DC/RF GND

The following function block in **Figure 2** shows the principal schematic how the BGB707L7ESD is used in a circuit. The Power On/Off function is controlled by applying V_{Ctrl} . By using an external resistor R_{ext} the pre-set current of 2.1 mA (which is adjusted by the integrated biasing when R_{ext} is omitted) can be increased. Base- and collector voltages are applied to the respective pins RF_{in} and RF_{out} by external inductors L_B and L_C .

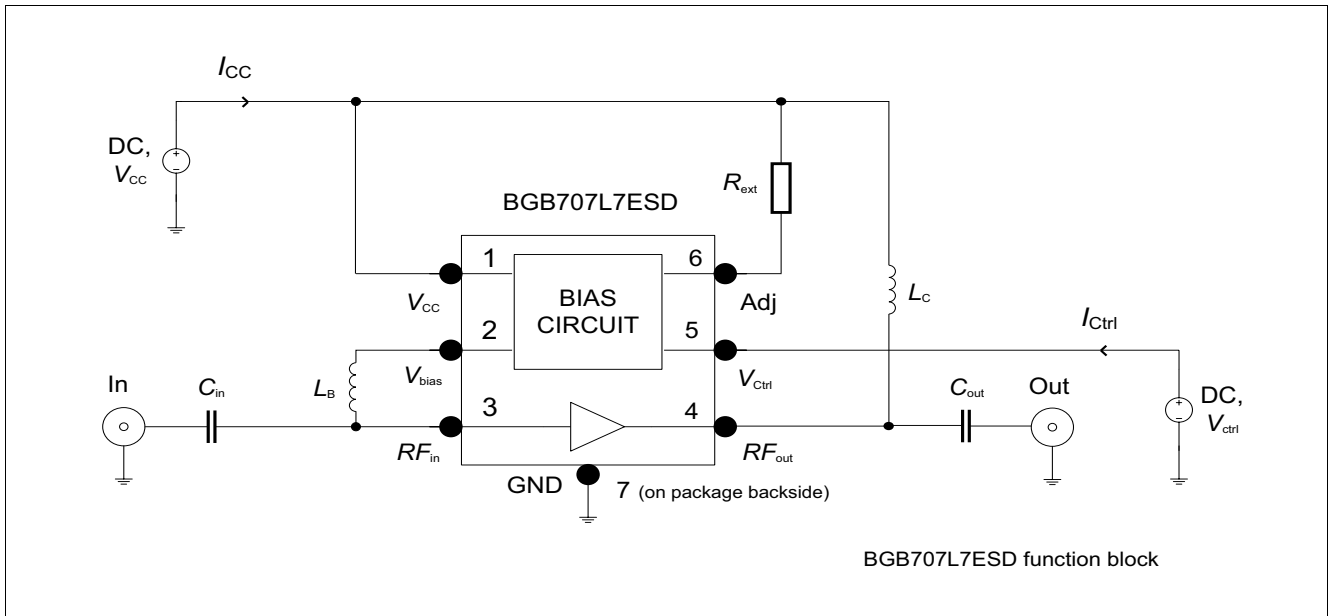

Figure 2 Function Block

3 Maximum Ratings

Table 2 Maximum Ratings at $T_A = 25^\circ\text{C}$ (unless otherwise specified)

Parameter	Symbol	Values			Unit	Note / Test Condition
		Min.	Typ.	Max.		
Supply Voltage	V_{CC}	–	–	4.0	V	–
$T_A = -55^\circ\text{C}$		–	–	3.5		–
Supply Current at V_{CC} pin	I_{CC}	–	–	25	mA	–
DC Current at RF In pin	I_B	–	–	2	mA	–
Voltage at Ctrl On/Off pin	V_{ctrl}	–	–	4.0	V	–
Total Power Dissipation $T_S < 112^\circ\text{C}^1)$	P_{tot}	–	–	100	mW	–
Operation Junction Temperature	T_{JOp}	–	–	150	$^\circ\text{C}$	–
Storage Temperature	T_{Stg}	-55	–	150	$^\circ\text{C}$	–

1) T_S is the soldering point temperature. T_S is measured at the GND pin (7) at the soldering point to the pcb

Attention: Stresses above the max. values listed here may cause permanent damage to the device. Exposure to absolute maximum rating conditions for extended periods may affect device reliability. Maximum ratings are absolute ratings; exceeding only one of these values may cause irreversible damage to the integrated circuit.

4 Thermal Characteristics

Table 3 Thermal Resistance

Parameter	Symbol	Values			Unit	Note / Test Condition
		Min.	Typ.	Max.		
Junction - Soldering Point ¹⁾	R_{thJS}	–	375	–	K/W	–

1) For calculation of R_{thJA} please refer to Application Note Thermal Resistance

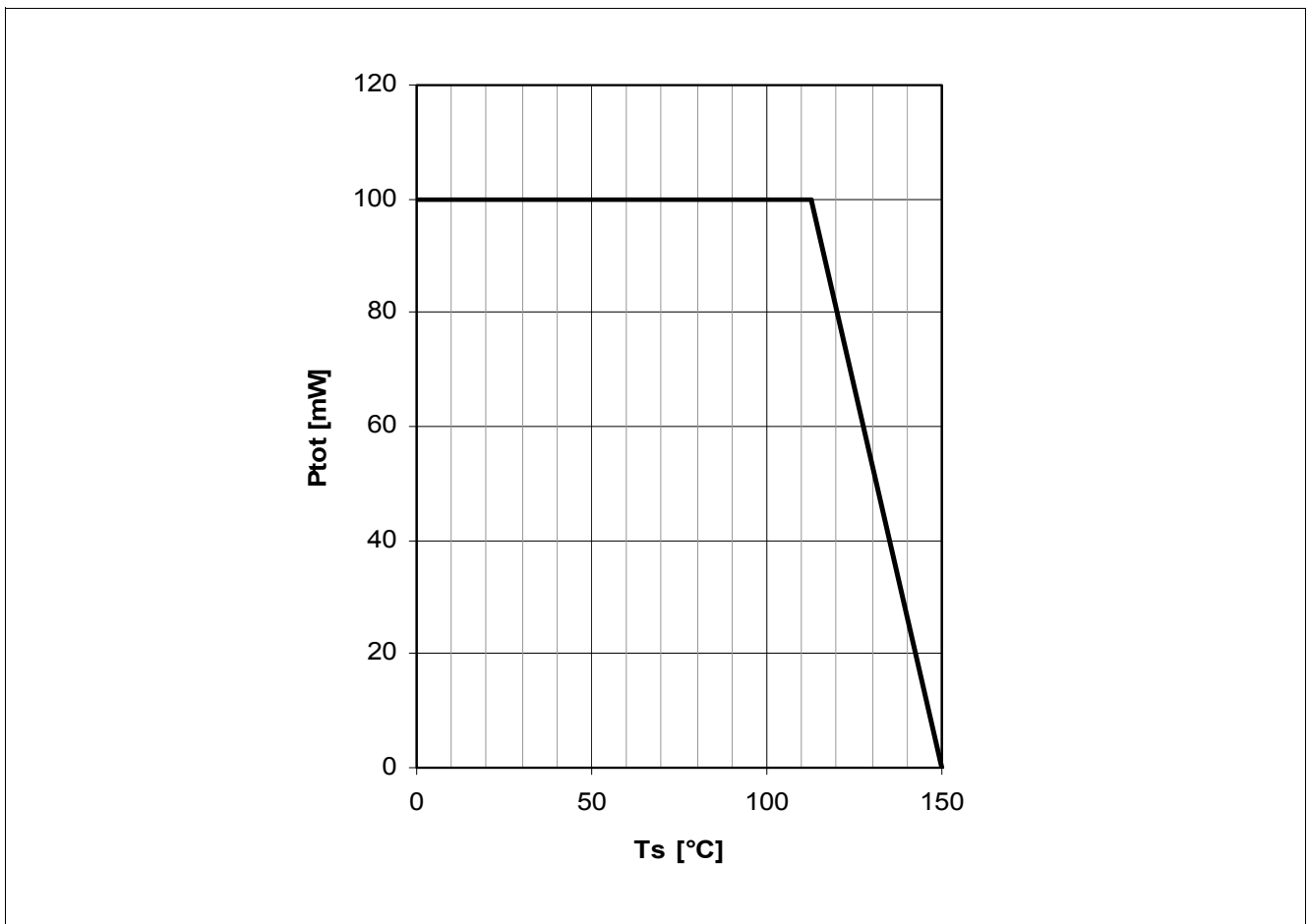

Figure 3 Total Power Dissipation $P_{tot} = f(T_s)$

5 Operation Conditions

Table 4 Operation Conditions

Parameter	Symbol	Values			Unit	Note / Test Condition
		Min.	Typ.	Max.		
Supply Voltage	V_{CC}	1.8	3.0	4.0	V	–
Voltage Ctrl On/Off pin in On mode	V_{ctrl}	1.2	–	V_{CC}	V	–
Voltage Ctrl On/Off pin in Off mode	V_{ctrl}	-0.3	–	0.3	V	–

6 Electrical Characteristics

6.1 DC Characteristics

Table 5 DC Characteristics at $V_{CC} = 3\text{ V}$, $T_A = 25^\circ\text{C}$

Parameter	Symbol	Values			Unit	Note / Test Condition
		Min.	Typ.	Max.		
Supply Current	I_{CC}	–	–	–	mA	$V_{Ctrl} = 3\text{ V}$ $R_{ext} = \text{open}$ $R_{ext} = 12\text{ k}\Omega$ $R_{ext} = 4.7\text{ k}\Omega$ $R_{ext} = 2.4\text{ k}\Omega$ $R_{ext} = 1\text{ k}\Omega$
		1.6	2.1	2.6		
		–	3	–		
		–	4.2	–		
		–	6	–		
		–	10	–		
Supply current in Off mode	I_{CC-off}	–	–	6	μA	$V_{Ctrl} = 0\text{ V}$
Current into V_{Ctrl} pin in On mode	$I_{Ctrl-on}$	–	14	20	μA	$V_{Ctrl} = 3\text{ V}$
Current into V_{Ctrl} pin in Off mode	$I_{Ctrl-off}$	–	–	0.1	μA	$V_{Ctrl} = 0\text{ V}$

6.2 Typical DC Characteristic Curves

The measurement setup is an application circuit according to [Figure 2](#) using the integrated biasing.
 $T_A = 25\text{ }^\circ\text{C}$ unless otherwise specified.

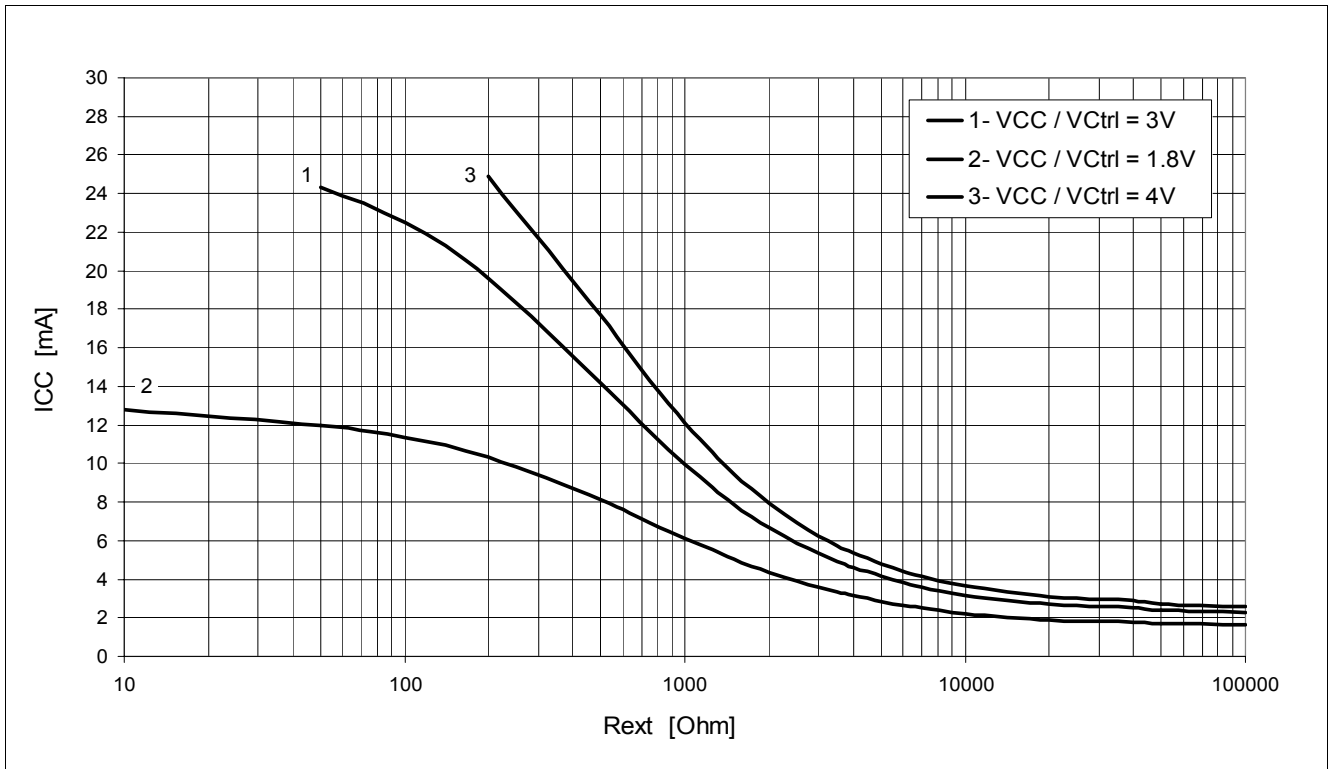

Figure 4 I_{CC} as a Function of R_{ext} , V_{CC} as Parameter

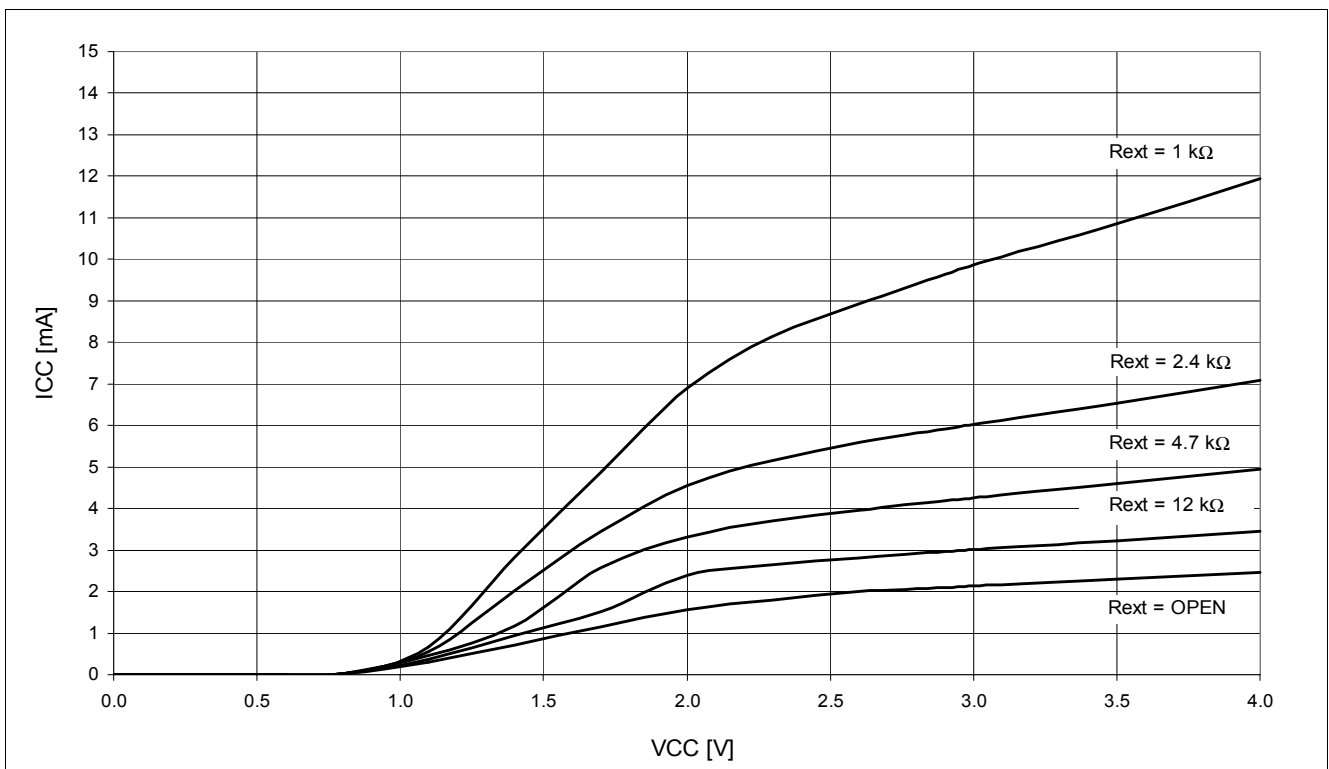

Figure 5 I_{CC} as a Function of V_{CC} , $V_{Ctrl} = 3V$, R_{ext} as Parameter

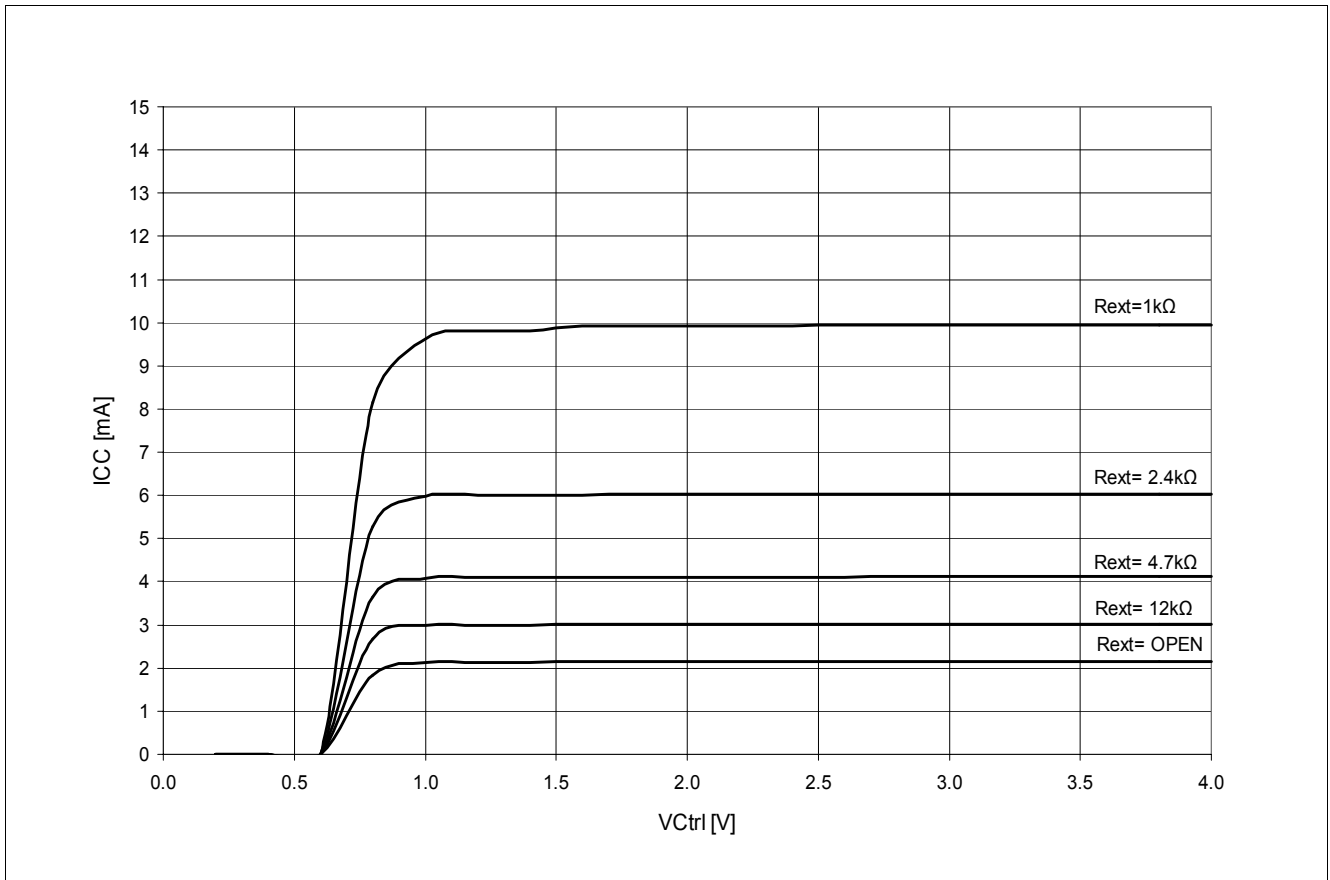

Figure 6 I_{CC} as a Function of V_{Ctrl} , $V_{CC} = 3\text{ V}$, R_{ext} as Parameter

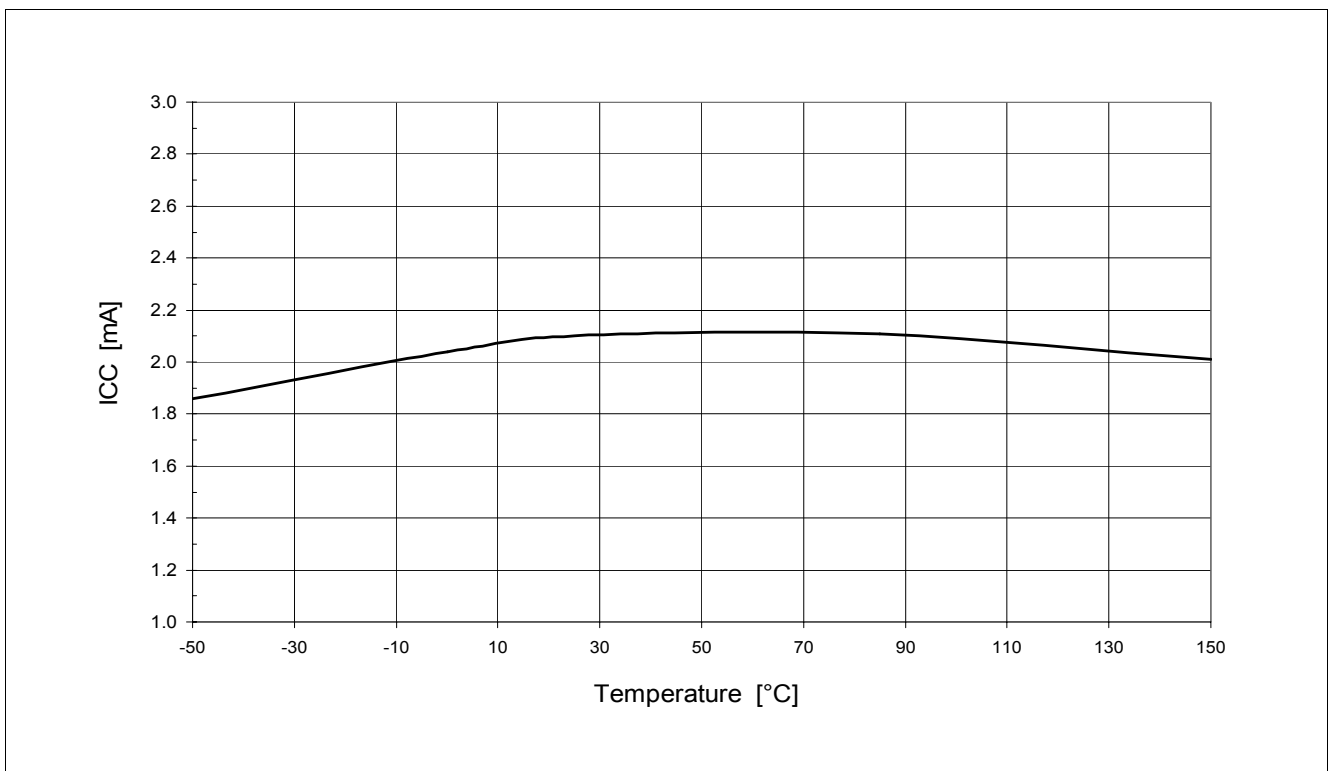

Figure 7 I_{CC} as a Function of Temperature, $V_{Ctrl} = V_{CC} = 3\text{ V}$, $R_{ext} = \text{open}$

6.3 AC Characteristics

AC characteristics are described in two sub-chapters, first for 100 MHz FM Radio applications, then for higher frequencies in a 50 Ω environment.

6.3.1 AC Characteristics in FM Radio Applications

Two BGB707L7ESD FM radio application notes are available on our website www.infineon.com/BGB707. Depending on the impedance of the used antenna, please consult AN177 for high-ohmic antennas and AN181 for 50 Ω antennas. In this chapter you find a summary of the electrical performance as described in these application notes in table form.

6.3.1.1 High-Ohmic FM Radio Antenna

$T_A = 25^\circ\text{C}$, $V_{CC} = 3.0\text{ V}$, $I_{CC} = 3.0\text{ mA}$, $V_{Ctrl} = 3.0\text{ V}$, $f = 100\text{ MHz}$, $R_{ext} = 12\text{ k}\Omega$

Table 6 AC Characteristics in the FM Radio Application as Described in AN177

Parameter	Symbol	Values			Unit	Note / Test Condition
		Min.	Typ.	Max.		
Transducer Gain	$ S_{21} ^2$	–	12	–	dB	–
Input Return Loss	RL_{IN}	–	0.5 ¹⁾	–	dB	–
Output Return Loss	RL_{OUT}	–	16	–	dB	–
Noise Figure ($Z_s = 50\ \Omega$)	NF	–	1.0	–	dB	–
Input 1 dB Gain Compression Point ²⁾	IP_{1dB}	–	-5.5	–	dBm	–
Input 3 rd Order Intercept Point ³⁾	IIP_3	–	-12.5	–	dBm	–

1) LNA presents a high input impedance match over the 76-108 MHz FM radio band.

2) I_{CC} increases as RF input power level approaches IP_{1dB} .

3) IIP_3 value depends on termination of all intermodulation frequency components. Termination used for the measurement is 50 Ω from 0.1 to 6 GHz.

6.3.1.2 50 Ω FM Radio Antenna

$T_A = 25^\circ\text{C}$, $V_{CC} = 2.8\text{ V}$, $I_{CC} = 4.2\text{ mA}$, $V_{Ctrl} = 2.8\text{ V}$, $f = 100\text{ MHz}$, $R_{ext} = 4.7\text{ k}\Omega$

Table 7 AC Characteristics in the FM Radio Application as Described in AN181

Parameter	Symbol	Values			Unit	Note / Test Condition
		Min.	Typ.	Max.		
Transducer Gain	$ S_{21} ^2$	13.5	15	16.5	dB	–
Input Return Loss	RL_{IN}	–	7.5	–	dB	–
Output Return Loss	RL_{OUT}	–	14.5	–	dB	–
Noise figure ($Z_s = 50\ \Omega$)	NF	–	1.35	1.9	dB	–
Input 1 dB Gain Compression Point ^{1) 2)}	IP_{1dB}	–	-10	–	dBm	–
Input 3 rd Order Intercept Point ²⁾³⁾	IIP_3	-7.5	-6	–	dBm	–

1) I_{CC} increases as RF input power level approaches IP_{1dB} .

2) Verified by random sampling

3) IIP_3 value depends on termination of all intermodulation frequency components. Termination used for the measurement is 50 Ω from 0.1 to 6 GHz.

6.3.2 AC Characteristics in the SDMB Application

A technical report TR122 for LNA applications in the frequency range 2.3 GHz to 2.7 GHz is available on our web page www.infineon.com/BGB707. In this chapter you find a summary of the electrical performance for the SDMB application as described in technical report TR122 in table form.

Table 8 AC Characteristics in the SDMB Application as Described in TR122, $T_A = 25^\circ\text{C}$

Parameter	Symbol	Values			Unit	Note / Test Condition
		Min.	Typ.	Max.		
Frequency Range	Freq	–	2.6	–	GHz	–
Supply Voltage	V_{cc}	–	2.8	–	V	–
Bias Current	I_{cc}	4.4	5.6	6.8	mA	–
Transducer Gain	$ S_{21} ^2$	13	15	17	dB	Power @ port1 = -30 dBm
Transducer Gain (off mode)	$ S_{21} ^2_{\text{off}}$	–	-18	–	dB	–
Noise Figure ($Z_s = 50 \Omega$)	NF	–	1.15	1.5	dB	Including 0.1 dB Board losses
Input Return Loss	RL_{IN}	–	13.2	–	dB	–
Output Return Loss	RL_{OUT}	–	12	–	dB	–
Reverse Isolation	I_{REV}	–	27.8	–	dB	Power @ port2 = -10 dBm
Input P1dB	IP_{1dB}	–	-9.6	–	dBm	–
Output P1dB	OP_{1dB}	–	4.4	–	dBm	–
Input IP3	IIP_3	–	-1.4	–	dBm	Input power = -30 dBm
Output IP3	OIP_3	–	13.6	–	dBm	–
On Switching Time	T_{on}	–	1.5	–	μs	Measured with $C_2 = 1 \text{ nF}$
Off Switching Time	T_{off}	–	4.2	–	μs	–
Stability	k	–	>1	–		Stability measured up to 10 GHz

6.3.3 AC Characteristics in Test Fixture

For frequencies from 150 MHz to 10 GHz the measurement setup is a test fixture with Bias-T's in a 50 Ω system according to **Figure 8** at $V_C = 3V$, $T_A = 25\text{ °C}$. The collector current I_C is controlled by an external base voltage V_B applied at RF_{in} pin and not by the integrated biasing's reference voltage V_{Bias} . V_C controls the collector voltage at RF_{out} pin. This allows direct measurement of the amplifier performance as a function of bias conditions without passive components.

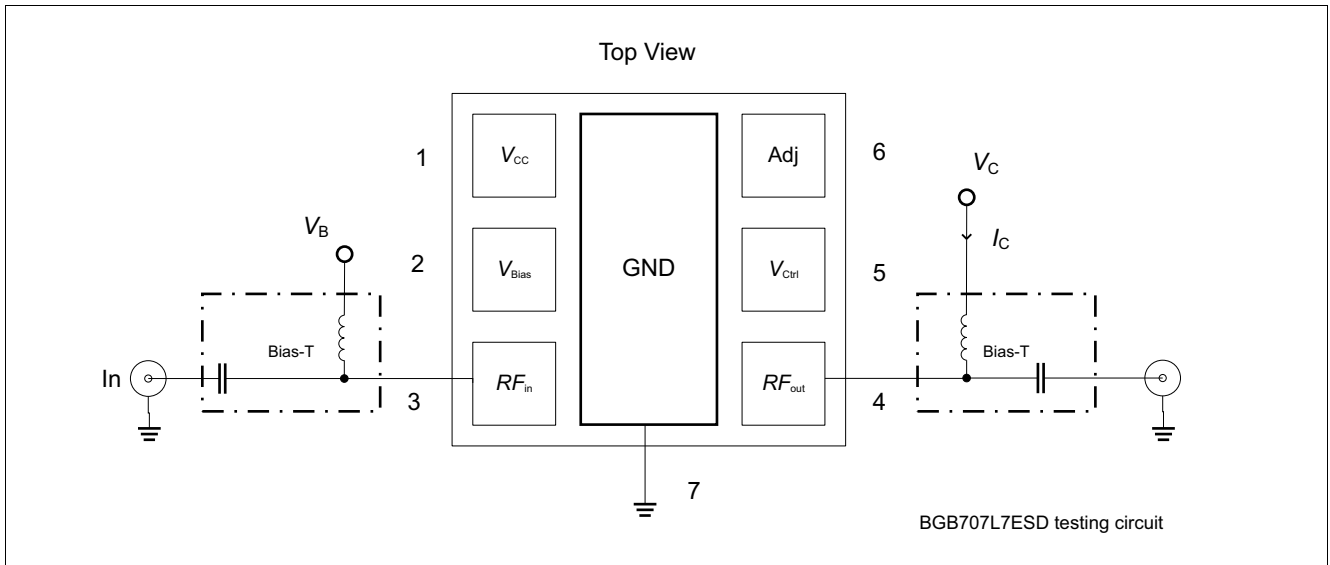

Figure 8 Testing Circuit for Frequencies from 150 MHz to 10 GHz

Table 9 AC Characteristics $V_C = 3\text{ V}$, $f = 150\text{ MHz}$

Parameter	Symbol	Values			Unit	Note / Test Condition
		Min.	Typ.	Max.		
Minimum Noise Figure	NF_{\min}	–	0.4	–	dB	$Z_S = Z_{\text{Sopt}}$
		–	0.4	–		$I_C = 2.1\text{ mA}$
		–	0.5	–		$I_C = 3\text{ mA}$
		–	0.55	–		$I_C = 6\text{ mA}$ $I_C = 10\text{ mA}$
Transducer Gain	$ S_{21} ^2$	–	17	–	dB	$Z_S = Z_L = 50\ \Omega$
		–	19	–		$I_C = 2.1\text{ mA}$
		–	24	–		$I_C = 3\text{ mA}$
		–	27	–		$I_C = 6\text{ mA}$ $I_C = 10\text{ mA}$
Maximum Power Gain	G_{ms}	–	31.5	–	dB	$Z_L = Z_{\text{Lopt}}$, $Z_S = Z_{\text{Sopt}}$
		–	33	–		$I_C = 2.1\text{ mA}$
		–	35	–		$I_C = 3\text{ mA}$
		–	37	–		$I_C = 6\text{ mA}$ $I_C = 10\text{ mA}$
Output 1 dB Compression Point ¹⁾	$OP_{1\text{dB}}$	–	3.5	–	dBm	$I_{\text{Cq}} = 2.1\text{ mA}$, $I_{\text{Ccomp}} = 11\text{ mA}$ ²⁾
		–	4	–		$I_{\text{Cq}} = 3\text{ mA}$, $I_{\text{Ccomp}} = 11\text{ mA}$
		–	4.5	–		$I_{\text{Cq}} = 6\text{ mA}$, $I_{\text{Ccomp}} = 11\text{ mA}$
		–	3	–		$I_{\text{Cq}} = 10\text{ mA}$, $I_{\text{Ccomp}} = 11\text{ mA}$
Output 3 rd Order Intercept Point	OIP_3	–	2	–	dBm	$I_C = 2.1\text{ mA}$
		–	6	–		$I_C = 3\text{ mA}$
		–	14.5	–		$I_C = 6\text{ mA}$
		–	19.5	–		$I_C = 10\text{ mA}$

1) $OP_{1\text{dB}}$ is the output compression point achieved in a $50\ \Omega$ application circuit according to [Figure 2](#) using the integrated biasing.

2) I_{Cq} is the quiescent current at small input power levels. I_{Cq} increases up to I_{Ccomp} as RF input power approaches $IP_{1\text{dB}}$, cf. [Figure 15](#).

Table 10 AC Characteristics $V_C = 3\text{ V}$, $f = 450\text{ MHz}$

Parameter	Symbol	Values			Unit	Note / Test Condition
		Min.	Typ.	Max.		
Minimum Noise Figure	NF_{\min}	–	0.45	–	dB	$Z_S = Z_{\text{Sopt}}$
		–	0.45	–		$I_C = 2.1\text{ mA}$
		–	0.5	–		$I_C = 3\text{ mA}$
		–	0.6	–		$I_C = 6\text{ mA}$ $I_C = 10\text{ mA}$
Transducer Gain	$ S_{21} ^2$	–	17	–	dB	$Z_S = Z_L = 50\ \Omega$
		–	19	–		$I_C = 2.1\text{ mA}$
		–	24	–		$I_C = 3\text{ mA}$
		–	27	–		$I_C = 6\text{ mA}$ $I_C = 10\text{ mA}$
Maximum Power Gain	G_{ms}	–	27	–	dB	$Z_L = Z_{\text{Lopt}}$, $Z_S = Z_{\text{Sopt}}$
		–	28	–		$I_C = 2.1\text{ mA}$
		–	30.5	–		$I_C = 3\text{ mA}$
		–	32	–		$I_C = 6\text{ mA}$ $I_C = 10\text{ mA}$
Output 1 dB Compression Point ¹⁾	$OP_{1\text{dB}}$	–	11.5	–	dBm	$I_{\text{Cq}} = 2.1\text{ mA}$, $I_{\text{Ccomp}} = 11\text{ mA}$ ²⁾
		–	12	–		$I_{\text{Cq}} = 3\text{ mA}$, $I_{\text{Ccomp}} = 14\text{ mA}$
		–	11.5	–		$I_{\text{Cq}} = 6\text{ mA}$, $I_{\text{Ccomp}} = 16\text{ mA}$
		–	9.5	–		$I_{\text{Cq}} = 10\text{ mA}$, $I_{\text{Ccomp}} = 15\text{ mA}$
Output 3 rd Order Intercept Point	OIP_3	–	2	–	dBm	$I_C = 2.1\text{ mA}$
		–	5.5	–		$I_C = 3\text{ mA}$
		–	14	–		$I_C = 6\text{ mA}$
		–	19.5	–		$I_C = 10\text{ mA}$

1) $OP_{1\text{dB}}$ is the output compression point achieved in a $50\ \Omega$ application circuit according to [Figure 2](#) using the integrated biasing.

2) I_{Cq} is the quiescent current at small input power levels. I_{Cq} increases up to I_{Ccomp} as RF input power approaches $IP_{1\text{dB}}$, cf. [Figure 15](#).

Table 11 AC Characteristics $V_C = 3\text{ V}$, $f = 900\text{ MHz}$

Parameter	Symbol	Values			Unit	Note / Test Condition
		Min.	Typ.	Max.		
Minimum Noise Figure	NF_{\min}	–	0.55	–	dB	$Z_S = Z_{\text{Sopt}}$ $I_C = 2.1\text{ mA}$ $I_C = 3\text{ mA}$ $I_C = 6\text{ mA}$ $I_C = 10\text{ mA}$
		–	0.55	–		
		–	0.6	–		
		–	0.7	–		
Transducer Gain	$ S_{21} ^2$	–	17	–	dB	$Z_S = Z_L = 50\ \Omega$ $I_C = 2.1\text{ mA}$ $I_C = 3\text{ mA}$ $I_C = 6\text{ mA}$ $I_C = 10\text{ mA}$
		–	19	–		
		–	23.5	–		
		–	26	–		
Maximum Power Gain	G_{ms}	–	24	–	dB	$Z_L = Z_{\text{Lopt}}$, $Z_S = Z_{\text{Sopt}}$ $I_C = 2.1\text{ mA}$ $I_C = 3\text{ mA}$ $I_C = 6\text{ mA}$ $I_C = 10\text{ mA}$
		–	25	–		
		–	27.5	–		
		–	29	–		
Output 1 dB Compression Point ¹⁾	$OP_{1\text{dB}}$	–	11	–	dBm	$I_{\text{Cq}} = 2.1\text{ mA}$, $I_{\text{Ccomp}} = 13\text{ mA}$ ²⁾ $I_{\text{Cq}} = 3\text{ mA}$, $I_{\text{Ccomp}} = 15\text{ mA}$ $I_{\text{Cq}} = 6\text{ mA}$, $I_{\text{Ccomp}} = 14\text{ mA}$ $I_{\text{Cq}} = 10\text{ mA}$, $I_{\text{Ccomp}} = 14\text{ mA}$
		–	11	–		
		–	10	–		
		–	8.5	–		
Output 3 rd Order Intercept Point	OIP_3	–	3.5	–	dBm	$I_C = 2.1\text{ mA}$ $I_C = 3\text{ mA}$ $I_C = 6\text{ mA}$ $I_C = 10\text{ mA}$
		–	8	–		
		–	17	–		
		–	19.5	–		

1) $OP_{1\text{dB}}$ is the output compression point achieved in a $50\ \Omega$ application circuit according to [Figure 2](#) using the integrated biasing.

2) I_{Cq} is the quiescent current at small input power levels. I_{Cq} increases up to I_{Ccomp} as RF input power approaches $IP_{1\text{dB}}$, cf. [Figure 15](#).

Table 12 AC Characteristics $V_C = 3\text{ V}$, $f = 1.5\text{ GHz}$

Parameter	Symbol	Values			Unit	Note / Test Condition
		Min.	Typ.	Max.		
Minimum Noise Figure	NF_{\min}	–	0.6	–	dB	$Z_S = Z_{\text{Sopt}}$
		–	0.6	–		$I_C = 2.1\text{ mA}$
		–	0.6	–		$I_C = 3\text{ mA}$
		–	0.7	–		$I_C = 10\text{ mA}$
Transducer Gain	$ S_{21} ^2$	–	16	–	dB	$Z_S = Z_L = 50\ \Omega$
		–	18.5	–		$I_C = 2.1\text{ mA}$
		–	22.5	–		$I_C = 3\text{ mA}$
		–	24.5	–		$I_C = 6\text{ mA}$
Maximum Power Gain	G_{ms}	–	21.5	–	dB	$Z_L = Z_{\text{Lopt}}, Z_S = Z_{\text{Sopt}}$
		–	23	–		$I_C = 2.1\text{ mA}$
		–	25.5	–		$I_C = 3\text{ mA}$
		–	27	–		$I_C = 6\text{ mA}$
Output 1 dB Compression Point ¹⁾	$OP_{1\text{dB}}$	–	10.5	–	dBm	$I_{\text{Cq}} = 2.1\text{ mA}, I_{\text{Ccomp}} = 14\text{ mA}^{2)}$
		–	10	–		$I_{\text{Cq}} = 3\text{ mA}, I_{\text{Ccomp}} = 16\text{ mA}$
		–	9	–		$I_{\text{Cq}} = 6\text{ mA}, I_{\text{Ccomp}} = 15\text{ mA}$
		–	8	–		$I_{\text{Cq}} = 10\text{ mA}, I_{\text{Ccomp}} = 15\text{ mA}$
Output 3 rd Order Intercept Point	OIP_3	–	3.5	–	dBm	$I_C = 2.1\text{ mA}$
		–	8	–		$I_C = 3\text{ mA}$
		–	17	–		$I_C = 6\text{ mA}$
		–	19.5	–		$I_C = 10\text{ mA}$

1) $OP_{1\text{dB}}$ is the output compression point achieved in a $50\ \Omega$ application circuit according to [Figure 2](#) using the integrated biasing.

2) I_{Cq} is the quiescent current at small input power levels. I_{Cq} increases up to I_{Ccomp} as RF input power approaches $IP_{1\text{dB}}$, cf. [Figure 15](#).

Table 13 AC Characteristics $V_C = 3\text{ V}$, $f = 1.9\text{ GHz}$

Parameter	Symbol	Values			Unit	Note / Test Condition
		Min.	Typ.	Max.		
Minimum Noise Figure	NF_{\min}	–	0.6	–	dB	$Z_S = Z_{\text{Sopt}}$
		–	0.6	–		$I_C = 2.1\text{ mA}$
		–	0.6	–		$I_C = 3\text{ mA}$
		–	0.7	–		$I_C = 10\text{ mA}$
Transducer Gain	$ S_{21} ^2$	–	16	–	dB	$Z_S = Z_L = 50\ \Omega$
		–	18	–		$I_C = 2.1\text{ mA}$
		–	21.5	–		$I_C = 3\text{ mA}$
		–	23	–		$I_C = 10\text{ mA}$
Maximum Power Gain	G_{ms}	–	21	–	dB	$Z_L = Z_{\text{Lopt}}, Z_S = Z_{\text{Sopt}}$
		–	22	–		$I_C = 2.1\text{ mA}$
		–	24	–		$I_C = 3\text{ mA}$
		–	26	–		$I_C = 10\text{ mA}$
Output 1 dB Compression Point ¹⁾	$OP_{1\text{dB}}$	–	10	–	dBm	$I_{\text{Cq}} = 2.1\text{ mA}, I_{\text{Ccomp}} = 15\text{ mA}^{2)}$
		–	10	–		$I_{\text{Cq}} = 3\text{ mA}, I_{\text{Ccomp}} = 16\text{ mA}$
		–	8.5	–		$I_{\text{Cq}} = 6\text{ mA}, I_{\text{Ccomp}} = 14\text{ mA}$
		–	8	–		$I_{\text{Cq}} = 10\text{ mA}, I_{\text{Ccomp}} = 14\text{ mA}$
Output 3 rd Order Intercept Point	OIP_3	–	3.5	–	dBm	$I_C = 2.1\text{ mA}$
		–	7.5	–		$I_C = 3\text{ mA}$
		–	17	–		$I_C = 6\text{ mA}$
		–	19.5	–		$I_C = 10\text{ mA}$

1) $OP_{1\text{dB}}$ is the output compression point achieved in a $50\ \Omega$ application circuit according to [Figure 2](#) using the integrated biasing.

2) I_{Cq} is the quiescent current at small input power levels. I_{Cq} increases up to I_{Ccomp} as RF input power approaches $IP_{1\text{dB}}$, cf. [Figure 15](#).

Table 14 AC Characteristics $V_C = 3\text{ V}$, $f = 2.4\text{ GHz}$

Parameter	Symbol	Values			Unit	Note / Test Condition
		Min.	Typ.	Max.		
Minimum Noise Figure	NF_{\min}	–	0.65	–	dB	$Z_S = Z_{\text{Sopt}}$ $I_C = 2.1\text{ mA}$ $I_C = 3\text{ mA}$ $I_C = 6\text{ mA}$ $I_C = 10\text{ mA}$
		–	0.6	–		
		–	0.6	–		
		–	0.7	–		
Transducer Gain	$ S_{21} ^2$	–	15.5	–	dB	$Z_S = Z_L = 50\ \Omega$ $I_C = 2.1\text{ mA}$ $I_C = 3\text{ mA}$ $I_C = 6\text{ mA}$ $I_C = 10\text{ mA}$
		–	17	–		
		–	20	–		
		–	21.5	–		
Maximum Power Gain	G_{ms}	–	20	–	dB	$Z_L = Z_{\text{Lopt}}$, $Z_S = Z_{\text{Sopt}}$ $I_C = 2.1\text{ mA}$ $I_C = 3\text{ mA}$ $I_C = 6\text{ mA}$ $I_C = 10\text{ mA}$
		–	21	–		
		–	23	–		
		–	25	–		
Output 1 dB Compression Point ¹⁾	$OP_{1\text{dB}}$	–	10	–	dBm	$I_{\text{Cq}} = 2.1\text{ mA}$, $I_{\text{Ccomp}} = 15\text{ mA}$ ²⁾ $I_{\text{Cq}} = 3\text{ mA}$, $I_{\text{Ccomp}} = 16\text{ mA}$ $I_{\text{Cq}} = 6\text{ mA}$, $I_{\text{Ccomp}} = 14\text{ mA}$ $I_{\text{Cq}} = 10\text{ mA}$, $I_{\text{Ccomp}} = 14\text{ mA}$
		–	10	–		
		–	9	–		
		–	8	–		
Output 3 rd Order Intercept Point	OIP_3	–	4.5	–	dBm	$I_C = 2.1\text{ mA}$ $I_C = 3\text{ mA}$ $I_C = 6\text{ mA}$ $I_C = 10\text{ mA}$
		–	9	–		
		–	17.5	–		
		–	19.5	–		

1) $OP_{1\text{dB}}$ is the output compression point achieved in a $50\ \Omega$ application circuit according to [Figure 2](#) using the integrated biasing.

2) I_{Cq} is the quiescent current at small input power levels. I_{Cq} increases up to I_{Ccomp} as RF input power approaches $IP_{1\text{dB}}$, cf. [Figure 15](#).

Electrical Characteristics

 Table 15 AC Characteristics $V_C = 3\text{ V}$, $f = 3.5\text{ GHz}$

Parameter	Symbol	Values			Unit	Note / Test Condition
		Min.	Typ.	Max.		
Minimum Noise Figure	NF_{\min}	–	0.8	–	dB	$Z_S = Z_{\text{Sopt}}$
		–	0.75	–		$I_C = 2.1\text{ mA}$
		–	0.7	–		$I_C = 3\text{ mA}$
		–	0.75	–		$I_C = 6\text{ mA}$
						$I_C = 10\text{ mA}$
Transducer Gain	$ S_{21} ^2$	–	13.5	–	dB	$Z_S = Z_L = 50\ \Omega$
		–	15.5	–		$I_C = 2.1\text{ mA}$
		–	18	–		$I_C = 3\text{ mA}$
		–	19	–		$I_C = 6\text{ mA}$
						$I_C = 10\text{ mA}$
Maximum Power Gain	G_{ms}	–	18.5	–	dB	$Z_L = Z_{\text{Lopt}}, Z_S = Z_{\text{Sopt}}$
		–	20	–		$I_C = 2.1\text{ mA}$
		–	22	–		$I_C = 3\text{ mA}$
		–	23.5	–		$I_C = 6\text{ mA}$
						$I_C = 10\text{ mA}$
Output 1 dB Compression Point ¹⁾	$OP_{1\text{dB}}$	–	10	–	dBm	$I_{\text{Cq}} = 2.1\text{ mA}, I_{\text{Ccomp}} = 16\text{ mA}^{2)}$
		–	10	–		$I_{\text{Cq}} = 3\text{ mA}, I_{\text{Ccomp}} = 16\text{ mA}$
		–	9	–		$I_{\text{Cq}} = 6\text{ mA}, I_{\text{Ccomp}} = 15\text{ mA}$
		–	8	–		$I_{\text{Cq}} = 10\text{ mA}, I_{\text{Ccomp}} = 15\text{ mA}$
Output 3 rd Order Intercept Point	OIP_3	–	5.5	–	dBm	$I_C = 2.1\text{ mA}$
		–	12	–		$I_C = 3\text{ mA}$
		–	17.5	–		$I_C = 6\text{ mA}$
		–	19	–		$I_C = 10\text{ mA}$

1) $OP_{1\text{dB}}$ is the output compression point achieved in a $50\ \Omega$ application circuit according to [Figure 2](#) using the integrated biasing.

2) I_{Cq} is the quiescent current at small input power levels. I_{Cq} increases up to I_{Ccomp} as RF input power approaches $IP_{1\text{dB}}$, cf. [Figure 15](#).

Table 16 AC Characteristics $V_C = 3\text{ V}$, $f = 5.5\text{ GHz}$

Parameter	Symbol	Values			Unit	Note / Test Condition
		Min.	Typ.	Max.		
Minimum Noise Figure	NF_{\min}	–	1.05	–	dB	$Z_S = Z_{\text{Sopt}}$ $I_C = 2.1\text{ mA}$ $I_C = 3\text{ mA}$ $I_C = 6\text{ mA}$ $I_C = 10\text{ mA}$
		–	1	–		
		–	0.9	–		
		–	0.95	–		
Transducer Gain	$ S_{21} ^2$	–	11.5	–	dB	$Z_S = Z_L = 50\ \Omega$ $I_C = 2.1\text{ mA}$ $I_C = 3\text{ mA}$ $I_C = 6\text{ mA}$ $I_C = 10\text{ mA}$
		–	13	–		
		–	15	–		
		–	15.5	–		
Maximum Power Gain	G_{ms}	–	17.5	–	dB	$Z_L = Z_{\text{Lopt}}$, $Z_S = Z_{\text{Sopt}}$ $I_C = 2.1\text{ mA}$ $I_C = 3\text{ mA}$ $I_C = 6\text{ mA}$ $I_C = 10\text{ mA}$
		–	18.5	–		
		–	20	–		
		–	19	–		
Output 1 dB Compression Point ¹⁾	$OP_{1\text{dB}}$	–	10.5	–	dBm	$I_{\text{Cq}} = 2.1\text{ mA}$, $I_{\text{Ccomp}} = 17\text{ mA}$ ²⁾ $I_{\text{Cq}} = 3\text{ mA}$, $I_{\text{Ccomp}} = 17\text{ mA}$ $I_{\text{Cq}} = 6\text{ mA}$, $I_{\text{Ccomp}} = 15\text{ mA}$ $I_{\text{Cq}} = 10\text{ mA}$, $I_{\text{Ccomp}} = 15\text{ mA}$
		–	10	–		
		–	9	–		
		–	8	–		
Output 3 rd Order Intercept Point	OIP_3	–	6.5	–	dBm	$I_C = 2.1\text{ mA}$ $I_C = 3\text{ mA}$ $I_C = 6\text{ mA}$ $I_C = 10\text{ mA}$
		–	12	–		
		–	22	–		
		–	21	–		

1) $OP_{1\text{dB}}$ is the output compression point achieved in a $50\ \Omega$ application circuit according to [Figure 2](#) using the integrated biasing.

2) I_{Cq} is the quiescent current at small input power levels. I_{Cq} increases up to I_{Ccomp} as RF input power approaches $IP_{1\text{dB}}$, cf. [Figure 15](#).

Table 17 AC Characteristics $V_C = 3\text{ V}$, $f = 10\text{ GHz}$

Parameter	Symbol	Values			Unit	Note / Test Condition
		Min.	Typ.	Max.		
Minimum Noise Figure	NF_{\min}	–	2	–	dB	$Z_S = Z_{\text{Sopt}}$ $I_C = 2.1\text{ mA}$ $I_C = 3\text{ mA}$ $I_C = 6\text{ mA}$ $I_C = 10\text{ mA}$
		–	1.8	–		
		–	1.5	–		
		–	1.5	–		
Transducer Gain	$ S_{21} ^2$	–	5.5	–	dB	$Z_S = Z_L = 50\ \Omega$ $I_C = 2.1\text{ mA}$ $I_C = 3\text{ mA}$ $I_C = 6\text{ mA}$ $I_C = 10\text{ mA}$
		–	7	–		
		–	9	–		
		–	10	–		
Maximum Power Gain	G_{ms}	–	14.5	–	dB	$Z_L = Z_{\text{Lopt}}$, $Z_S = Z_{\text{Sopt}}$ $I_C = 2.1\text{ mA}$ $I_C = 3\text{ mA}$ $I_C = 6\text{ mA}$ $I_C = 10\text{ mA}$
		–	15	–		
		–	15.5	–		
		–	15.5	–		
Output 1 dB Compression Point ¹⁾	$OP_{1\text{dB}}$	–	6	–	dBm	$I_{\text{Cq}} = 2.1\text{ mA}$, $I_{\text{Ccomp}} = 16\text{ mA}^{2)}$ $I_{\text{Cq}} = 3\text{ mA}$, $I_{\text{Ccomp}} = 16\text{ mA}$ $I_{\text{Cq}} = 6\text{ mA}$, $I_{\text{Ccomp}} = 15\text{ mA}$ $I_{\text{Cq}} = 10\text{ mA}$, $I_{\text{Ccomp}} = 15\text{ mA}$
		–	6	–		
		–	4	–		
		–	4	–		
Output 3 rd Order Intercept Point	OIP_3	–	2.5	–	dBm	$I_C = 2.1\text{ mA}$ $I_C = 3\text{ mA}$ $I_C = 6\text{ mA}$ $I_C = 10\text{ mA}$
		–	7	–		
		–	19.5	–		
		–	18	–		

1) $OP_{1\text{dB}}$ is the output compression point achieved in a $50\ \Omega$ application circuit according to [Figure 2](#) using the integrated biasing.

2) I_{Cq} is the quiescent current at small input power levels. I_{Cq} increases up to I_{Ccomp} as RF input power approaches $IP_{1\text{dB}}$, cf. [Figure 15](#).

6.3.4 Typical AC Characteristic Curves

The measurement setup is the same as described in Figure 8 except for Figure 15 where compression is measured in a 50 Ohm application circuit according to Figure 2 using the integrated biasing; $V_C = 3V$, $T_A = 25^\circ C$.

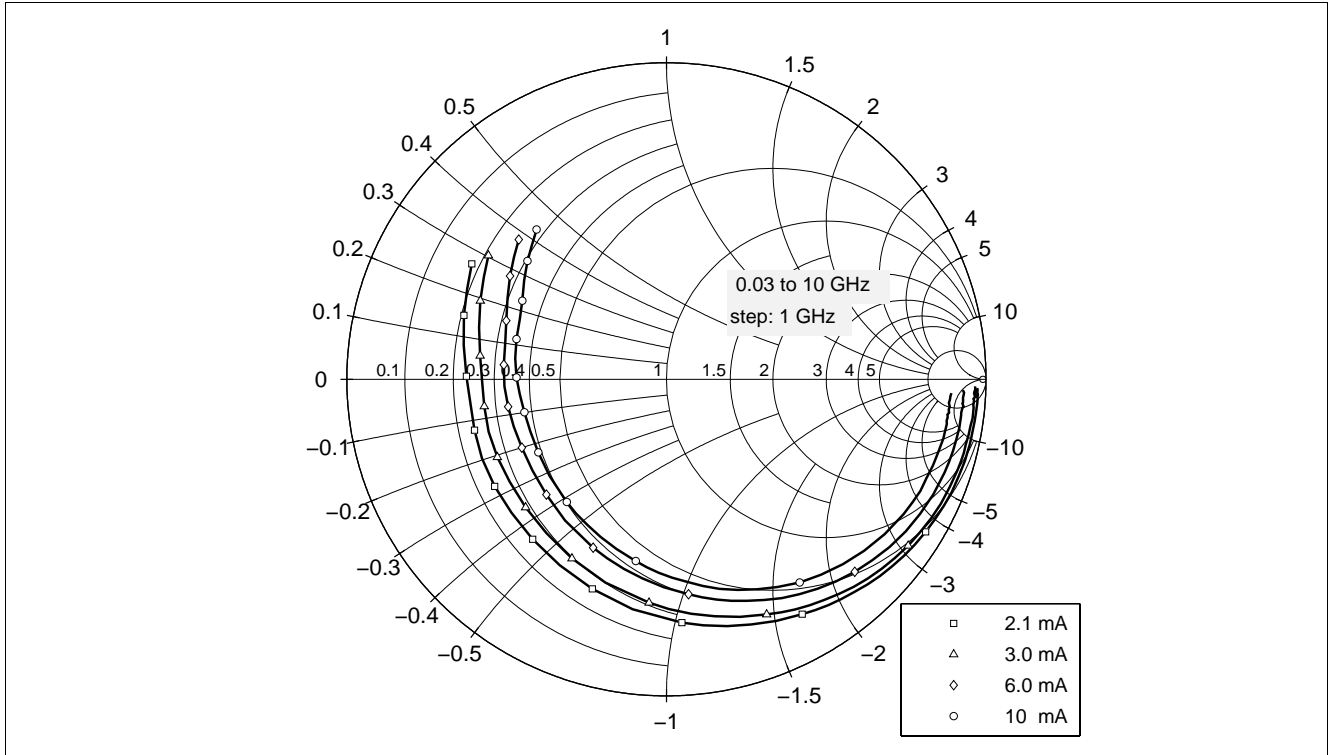

Figure 9 S_{11} as a Function of Frequency, I_C as Parameter

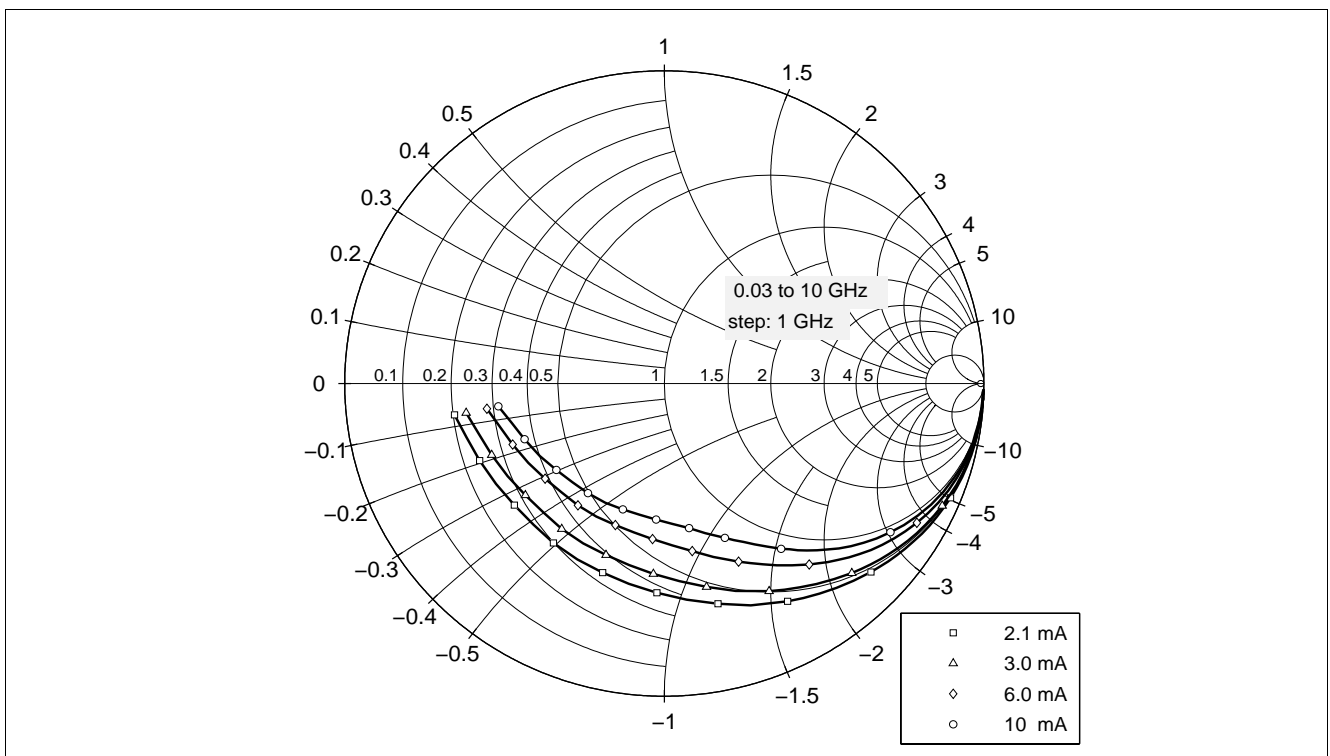

Figure 10 S_{22} as a Function of Frequency, I_C as Parameter

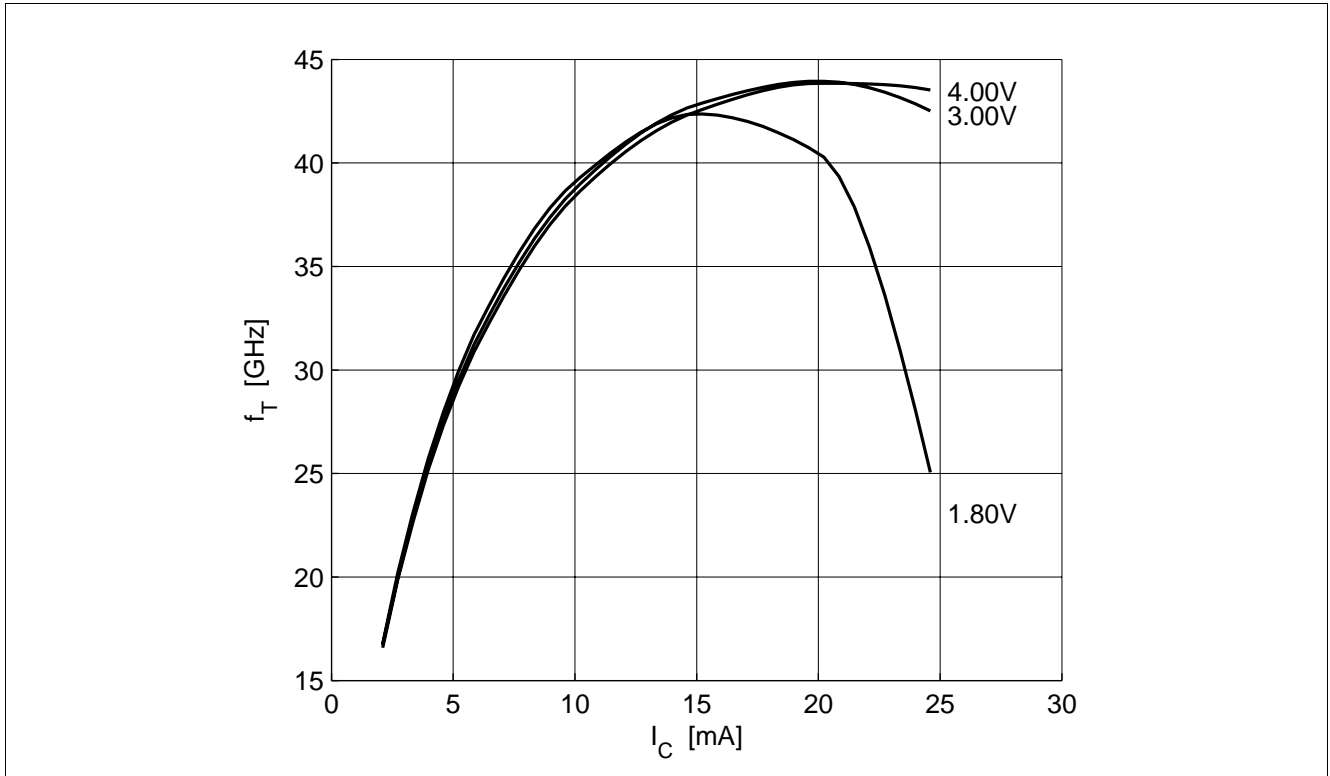

Figure 11 Transition Frequency as a Function of I_C , V_C as Parameter

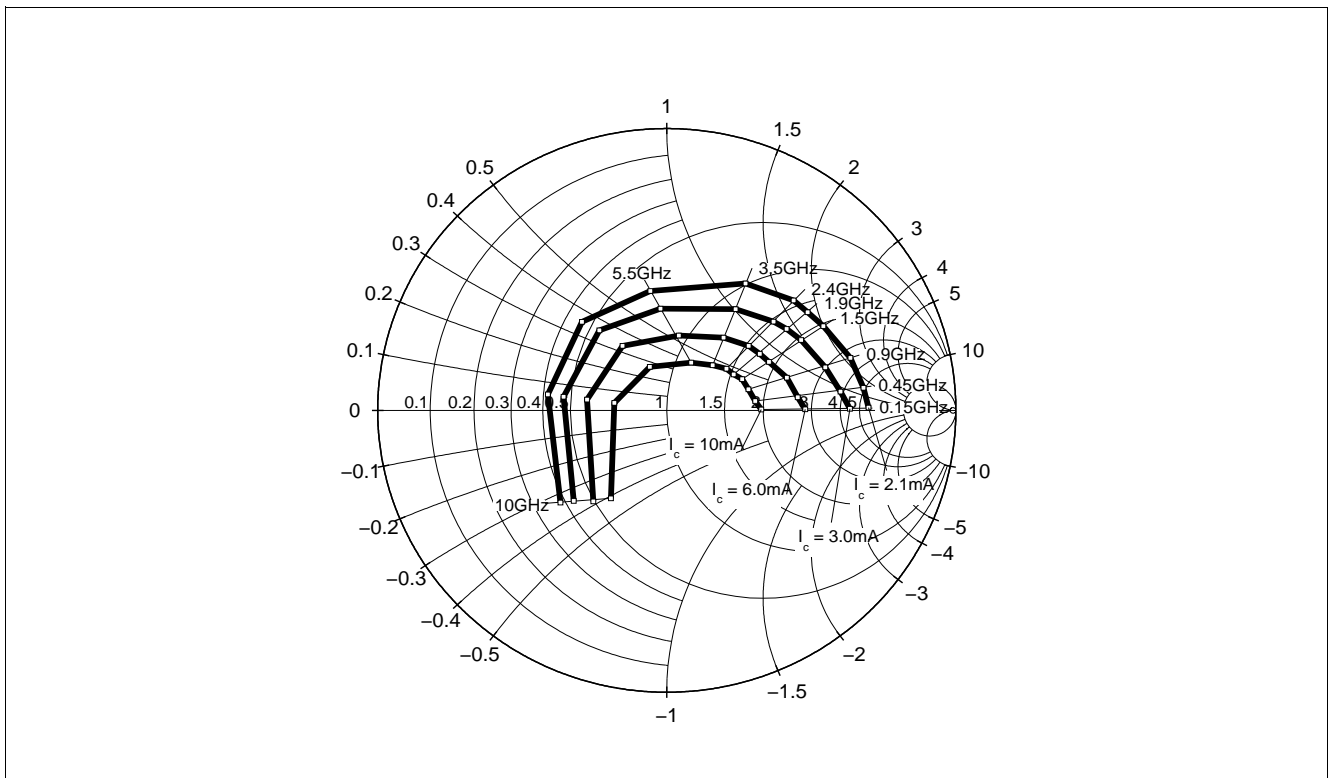

Figure 12 Optimum Source Impedance for Minimum NF as a Function of Frequency, I_C as Parameter

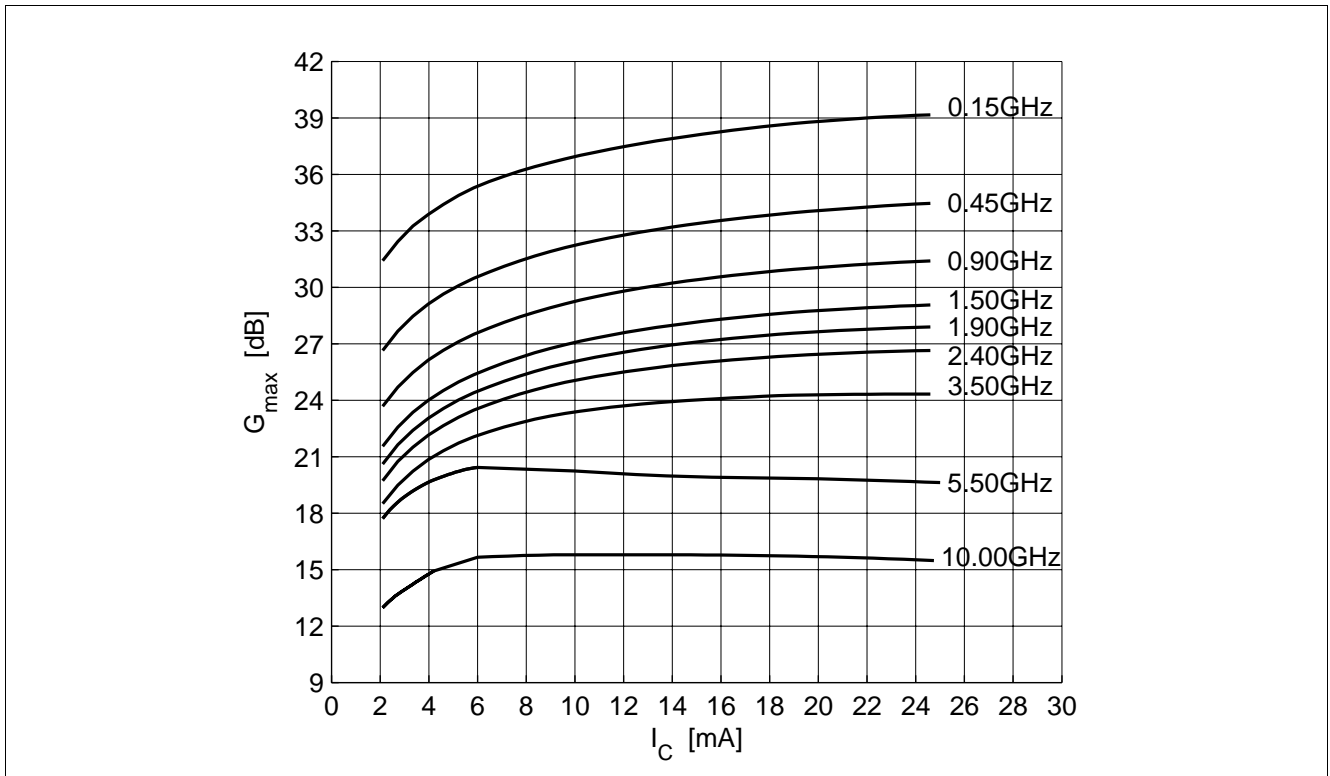

Figure 13 Maximum Power Gain as a Function of I_C , Frequency as Parameter

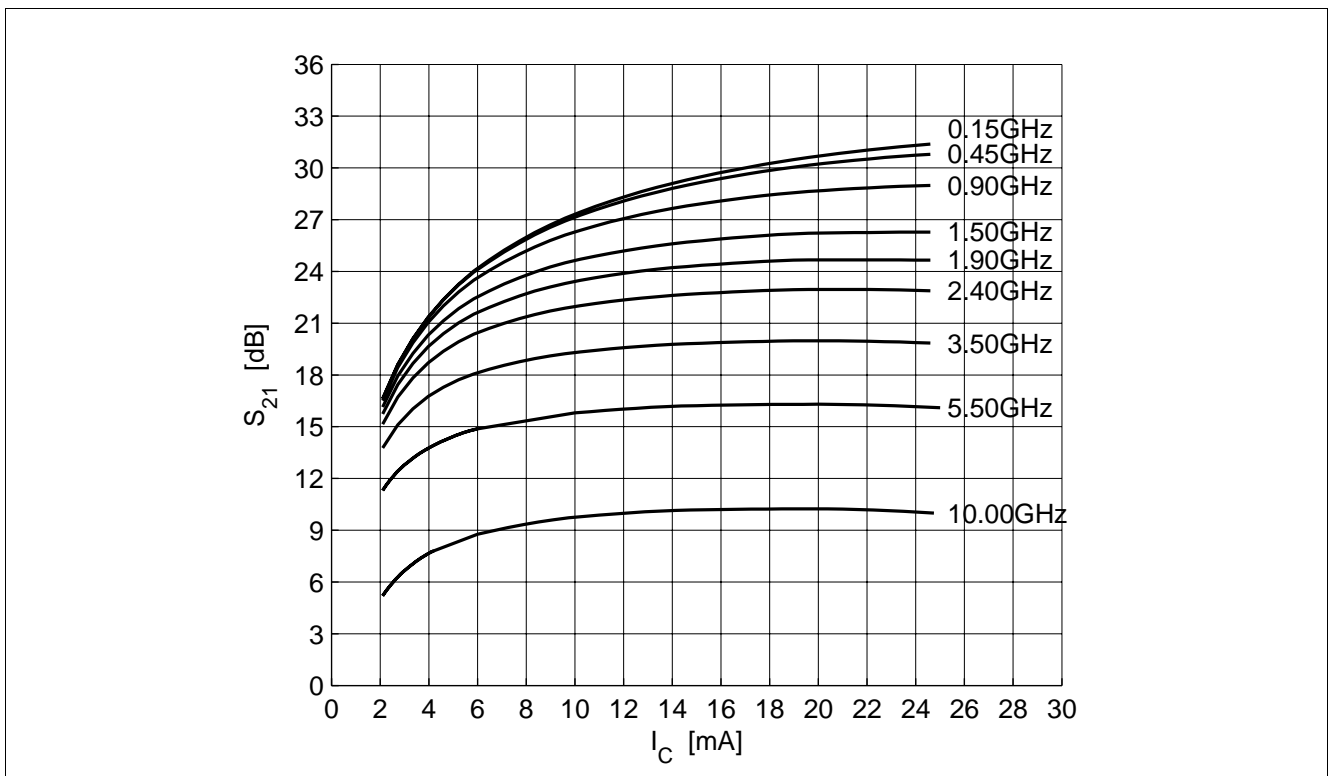

Figure 14 Power Gain as a Function of I_C , Frequency as Parameter

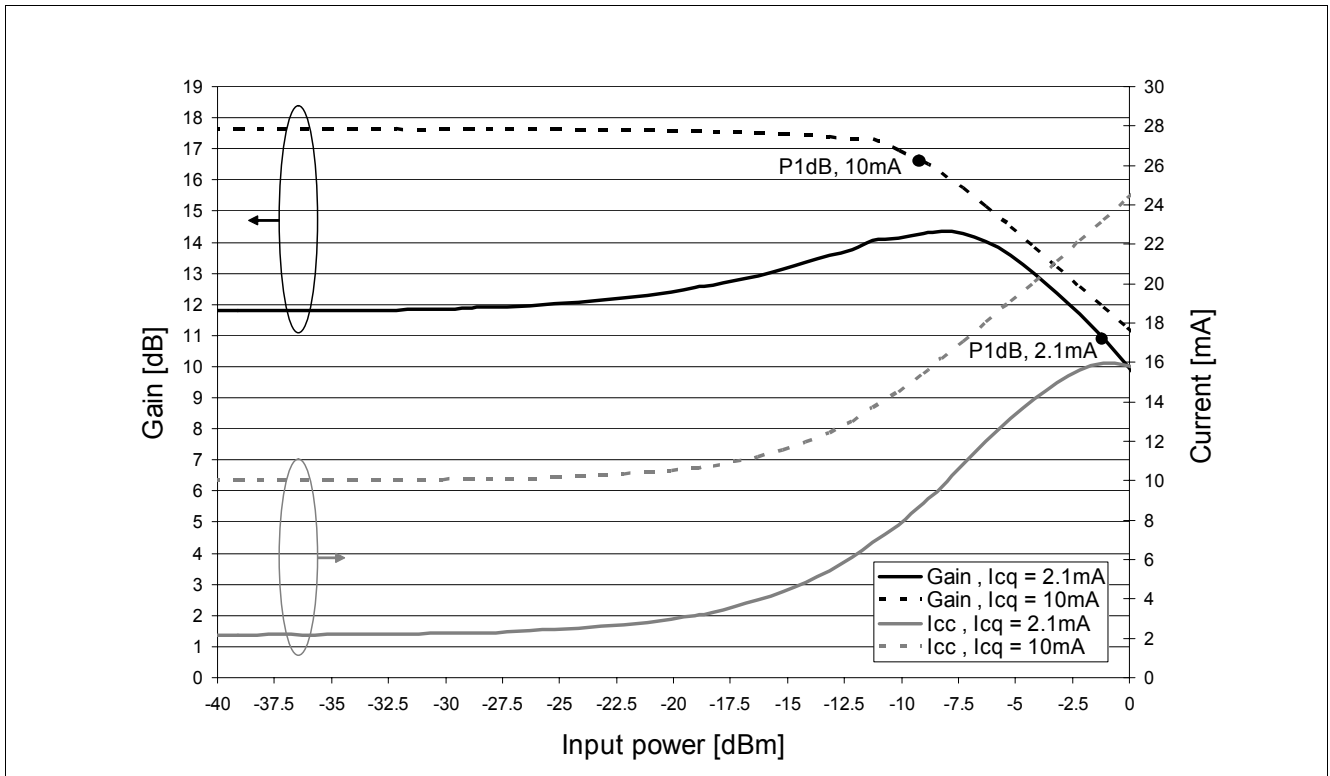

Figure 15 Power Gain and Total Supply Current as a Function of RF Input Power at 3.5 GHz

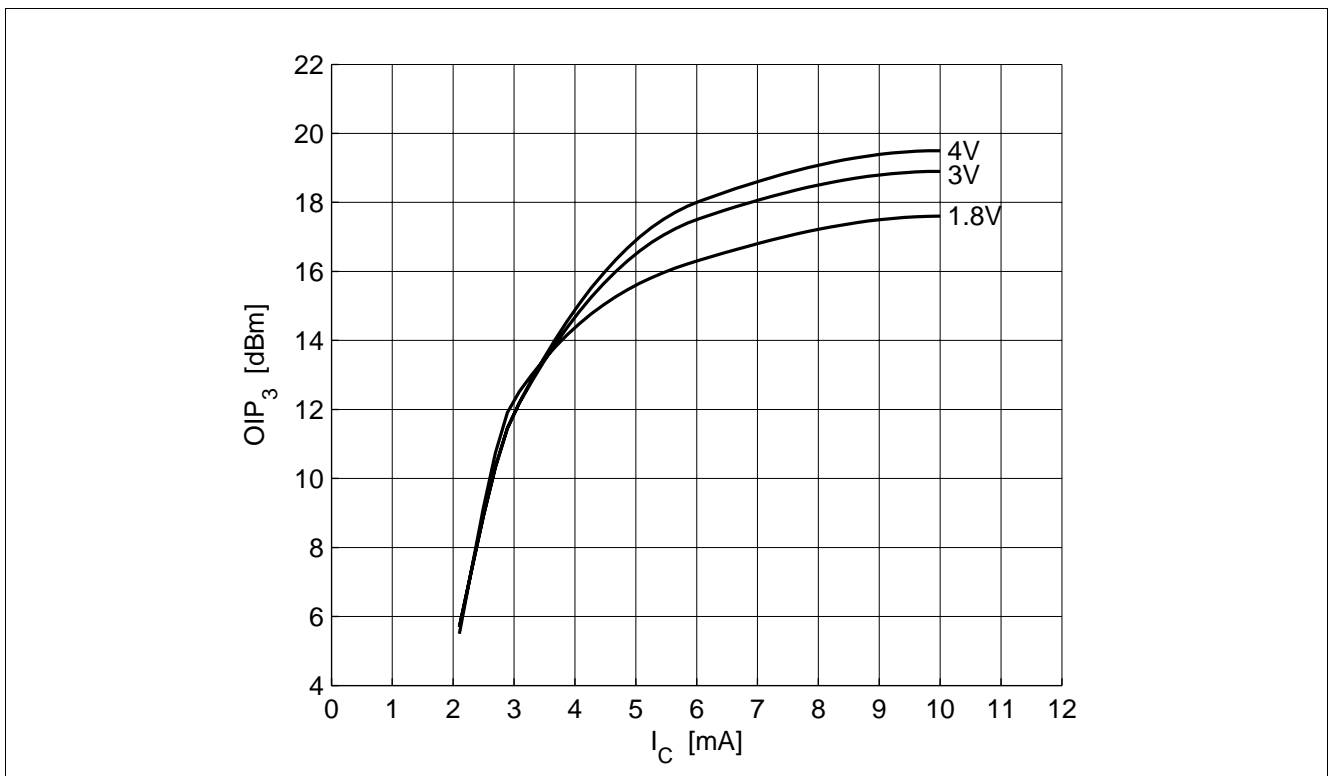

Figure 16 Output 3rd Order Intercept Point as a Function of I_C at 3.5 GHz, V_C as Parameter

7 Package Information

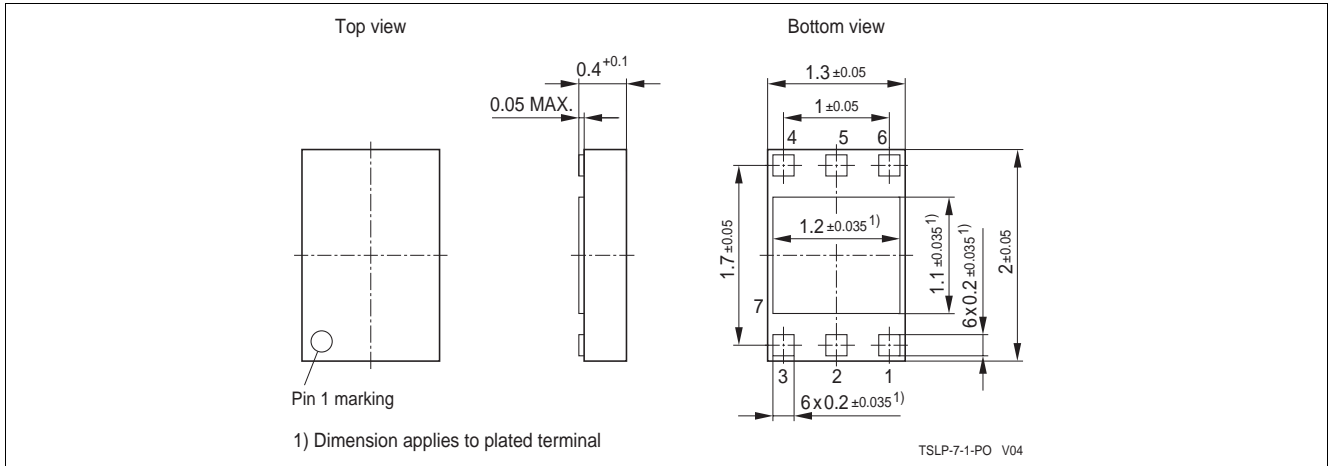

Figure 17 Package Outline TSLP-7-1

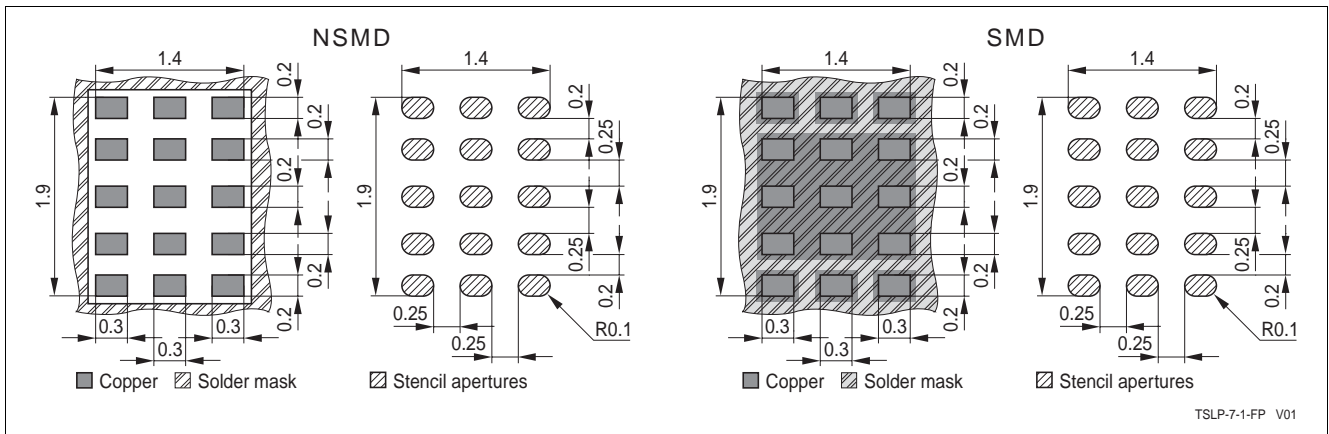

Figure 18 Footprint

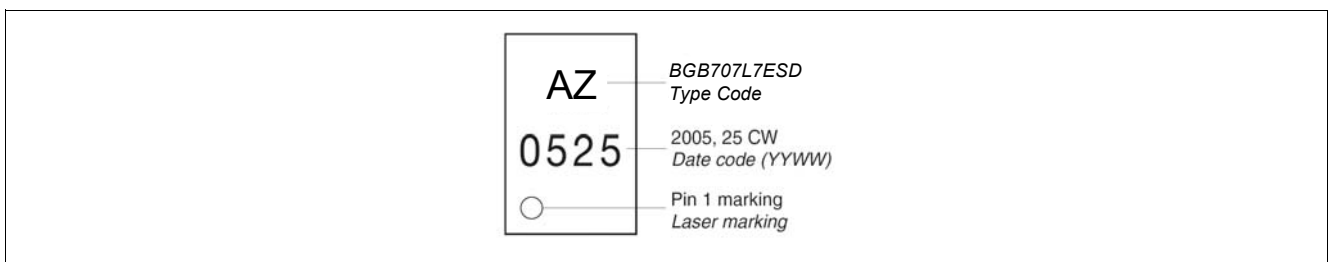

Figure 19 Marking Layout (top view)

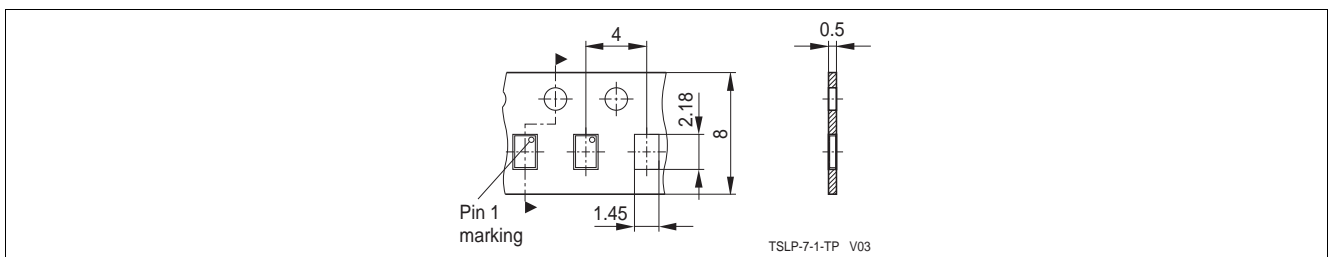

Figure 20 Tape Dimensions

www.infineon.com

Published by Infineon Technologies AG



Компания «ЭлектроПласт» предлагает заключение долгосрочных отношений при поставках импортных электронных компонентов на взаимовыгодных условиях!

Наши преимущества:

- Оперативные поставки широкого спектра электронных компонентов отечественного и импортного производства напрямую от производителей и с крупнейших мировых складов;
- Поставка более 17-ти миллионов наименований электронных компонентов;
- Поставка сложных, дефицитных, либо снятых с производства позиций;
- Оперативные сроки поставки под заказ (от 5 рабочих дней);
- Экспресс доставка в любую точку России;
- Техническая поддержка проекта, помощь в подборе аналогов, поставка прототипов;
- Система менеджмента качества сертифицирована по Международному стандарту ISO 9001;
- Лицензия ФСБ на осуществление работ с использованием сведений, составляющих государственную тайну;
- Поставка специализированных компонентов (Xilinx, Altera, Analog Devices, Intersil, Interpoint, Microsemi, Aeroflex, Peregrine, Syfer, Eurofarad, Texas Instrument, Miteq, Cobham, E2V, MA-COM, Hittite, Mini-Circuits, General Dynamics и др.);

Помимо этого, одним из направлений компании «ЭлектроПласт» является направление «Источники питания». Мы предлагаем Вам помощь Конструкторского отдела:

- Подбор оптимального решения, техническое обоснование при выборе компонента;
- Подбор аналогов;
- Консультации по применению компонента;
- Поставка образцов и прототипов;
- Техническая поддержка проекта;
- Защита от снятия компонента с производства.



Как с нами связаться

Телефон: 8 (812) 309 58 32 (многоканальный)

Факс: 8 (812) 320-02-42

Электронная почта: org@eplast1.ru

Адрес: 198099, г. Санкт-Петербург, ул. Калинина, дом 2, корпус 4, литера А.