



## FEATURES

- Industry-standard through-hole eighth-brick package with 0.9" x 2.3" x 0.38" outline dimensions
- Choice of two wide input ranges, 9-36 Vdc or 18-75 Vdc
- Fixed output from 3.3 to 24 Volts DC up to 75 Watts
- Synchronous rectification yields very high efficiency and low power dissipation
- Operating temperature range from -40 to +85°C with derating
- Up to 2250 Volt DC isolation (Q48 models)
- Outstanding thermal performance and derating
- Extensive self-protection, overtemperature and overload features with no output reverse conduction
- On/Off control, trim and remote sense functions
- Certified to UL/EN/IEC 60950-1, CAN/CSA-C22.2 No. 60950-1, 2nd Edition, safety approvals and EN55022/CISPR22 standards
- Pre-bias operation for startup protection

## PRODUCT OVERVIEW

With dimensions of only 0.9 by 2.3 by 0.38 inches, the UWE series open frame DC-DC converters deliver up to 75 Watts in an industry-standard "eighth-brick" through-hole package. This format can plug directly into quarter-brick pinouts. Several standard fixed-output voltages from 3.3 Vdc to 24 Vdc assure compatibility in embedded equipment, CPU cards and instrument subsystems. The extended 4-to-1 input power range (9-36V) is ideal for battery-powered, telecom or portable applications. Very high efficiency means no fans or temperature deratings in many applications. An optional thermal mounting baseplate extends operation into most conceivable environments.

The synchronous rectifier design uses the maximum available duty cycle for greatest efficiency and low power dissipation with no reverse output conduction. Other features include low on-resistance FET's, planar magnetics and heavy-copper PC boards. These deliver low output noise,

tight line/load regulation, stable no-load operation and fast load step response. All units are precision assembled in a highly automated facility with ISO-traceable manufacturing quality standards.

Isolation of 2250 Volts (Q48 models) assures safety and fully differential (floating) operation for greatest application flexibility. On-board Sense inputs compensate for line drop errors at high output currents. Outputs are trimmable within  $\pm 10\%$  of nominal voltage. The UWE series are functionally complete.

A wealth of protection features prevents damage to both the converter and outside circuits. Inputs are protected from undervoltage and outputs feature short circuit protection, overcurrent and excess temperature shut down. Overloads automatically recover using the "hiccup" technique upon fault removal. The UWE is certified to standard safety and EMI/RFI approvals. All units meet RoHS-6 hazardous materials compliance.



Figure 1. Simplified Block Diagram



Q48 models only

PERFORMANCE SPECIFICATIONS SUMMARY AND ORDERING GUIDE ①														
Root Model ①	Output						Input				Efficiency		Package (Case, Pinout)	
	V <sub>OUT</sub> (V)	I <sub>OUT</sub> (A)	Power (W)	R/N (mVp-p) ③		Regulation (max.)		V <sub>IN</sub> Nom. (V)	Range (V)	I <sub>IN</sub> , no load (mA)	I <sub>IN</sub> , full load (A)	Min.		Typ.
				Typ.	Max.	Line	Load							
UWE-3.3/20-Q12	3.3	20	66	80	125	±0.25%	±0.25%	12	9-36	160	6.18	87%	89%	C77, P32
UWE-3.3/20-Q48	3.3	20	66	165	225	±0.2%	±0.25%	48	18-75	75	1.54	88%	89.5%	
UWE-5/15-Q12	5.0	15	75	80	125	±0.25%	±0.125%	12	9-36	185	6.87	89%	91%	
UWE-5/15-Q48	5.0	15	75	135	150	±0.2%	±0.15%	48	18-75	90	1.74	88.5%	90%	
UWE-12/6-Q12	12.0	6	72	120	180	±0.125%	±0.05%	12	9-36	200	6.56	90%	91.5%	
UWE-12/6-Q48	12.0	6	72	115	150	±0.1%	±0.075%	48	18-75	90	1.65	89%	91%	
UWE-15/5-Q12	15.0	5	75	65	125	±0.125%	±0.075%	12	9-36	270	6.83	89.5%	91.5%	
UWE-15/5-Q48	15.0	5	75	90	150	±0.125%	±0.125%	48	18-75	90	1.73	89%	90.5%	
UWE-24/3-Q12 ⑤	24.0	3	72	190	275	±0.125%	±0.125%	12	9-36	110	6.70	88.3%	89.5%	

- ① Please refer to the part number structure for additional ordering model numbers and options.
- ② All specifications are at nominal line voltage, nominal output voltage and full load, +25° C. unless otherwise noted. See detailed specifications.
- ③ Output capacitors are 1 µF ceramic in parallel with 10 µF electrolytic. Input cap is 100 µF. All caps are low ESR types. Contact Murata Power Solutions for details.

- ④ I/O caps are necessary for our test equipment and may not be needed for your application.
- ⑤ Load regulation range: 0.1-3A. This is required only for our test equipment. The converter will operate at zero output current with degraded regulation.

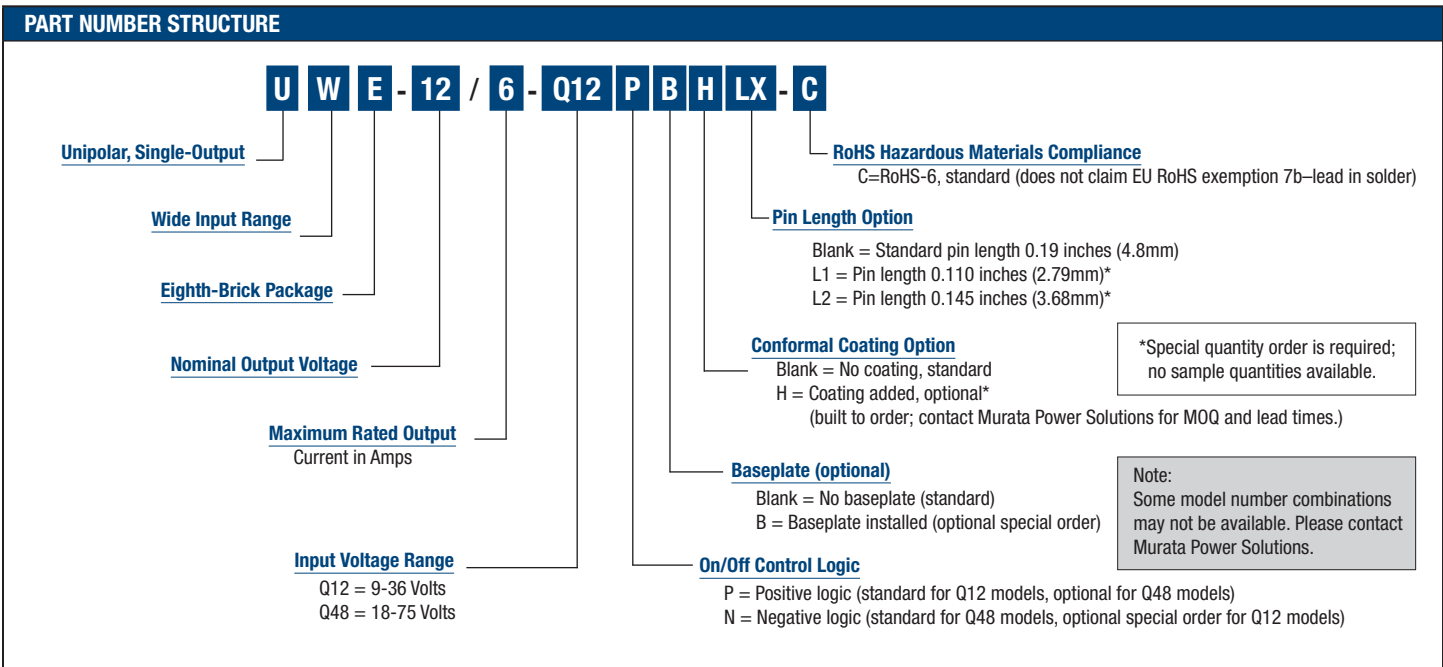

**Special Customer Configuration part numbers:**

- 1) UWE-12/6-Q48NB-C-CIS
- 2) UWE-12/6-Q48NBL1-C-CIS
- 3) UWE-15/5-Q12P-31318-C (tested to 2500Vdc isolation; all other standard product specifications plus conformal coating apply.)

FUNCTIONAL SPECIFICATIONS, Q12 MODELS					
	UWE-3.3/20-Q12	UWE-5/15-Q12	UWE-12/6-Q12	UWE-15/5-Q12	UWE-24/3-Q12 <sup>®</sup>
Specs are typical unless noted.					
<b>INPUT</b>					
Input voltage range	See ordering guide				
Start-up threshold, Volts	9.5	9			
Undervoltage shutdown, V.	8.5	8	8	8.2	8
Overshoot shutdown, V.	none				
Reflected (back) ripple current, mA pk-pk <sup>②</sup>	25	10	40	1	40
Suggested external fast blow fuse, A	25	20	20	20	20
<b>Input current</b>					
Full load conditions	See ordering guide				
Inrush transient, A <sup>2</sup> sec	0.1 A <sup>2</sup> sec				
Input current if output is in short circuit, mA	250	200	250	250	250
No load, mA	160	185	200	270	110
Low line (Vin=min.), Amps	8.33	9.42	8.89	9.36	9.04
Standby mode, mA	8	5	5	5	5
(Off, UV, OT shutdown) Internal input filter type	L-C				
Reverse polarity protection	None, install external fuse				
<b>Remote On/Off control</b>					
Positive logic ("P" model suffix)	OFF=Ground pin to +0.8V max.				
	ON=open pin or +3.5 to +15V max.				
Negative logic ("N" model suffix)	OFF=open pin or +5V to +15V max.				
	ON=Ground pin or 0 to +0.8V max.				
Current, mA	1				
<b>OUTPUT</b>					
Voltage output range	See ordering guide				
Voltage output accuracy	±1% of Vnom., (50% load)				
Adjustment range	-10 to +10% of Vnom.				
Temperature coefficient	±0.02% of Vout range per °C				
Minimum loading	No minimum load				
Remote sense compensation	+10% max.				
Ripple/noise (20 MHz bandwidth)	See ordering guide				
Line/Load regulation	See ordering guide				
Efficiency	See ordering guide				
Maximum capacitive loading, µF low ESR, resistive load	10,000	10,000	4,700	4700	1500
<b>Isolation voltage</b>					
Input to Output, Volts min. DC	1500				
Input to baseplate, Volts min. DC	1500				
Baseplate to output, Volts min. DC	750				
Isolation resistance, MΩ	100				
Isolation capacitance, pF	1500	1000	1000	1000	1000
Isolation safety rating	Basic insulation				
Current limit inception (98% of Vout, after warmup), Amps	27	22.5	8.5	7.25	4.0
Short circuit protection method	Current limiting, hiccup autorestart. Remove overload for recovery.				
Short circuit current, Amps	0.5	1.0	1.5	1.5	1.0
Short circuit duration	Continuous, output shorted to ground. No damage.				
Overshoot protection, Volts (via magnetic feedback)	4.5	6	15	18	29

FUNCTIONAL SPECIFICATIONS, Q12 MODELS, CONTINUED					
DYNAMIC CHARACTERISTICS	UWE-3.3/20-Q12	UWE-5/15-Q12	UWE-12/6-Q12	UWE-15/5-Q12	UWE-24/3-Q12
Dynamic load response, $\mu$ Sec (50-75-50% load step) to $\pm 1\%$ of final value	50				
Start-up time					
Vin to Vout regulated, mSec	20	20	40	30	40
Remote On/Off to Vout regulated, mSec	5	15	30	25	30
Switching frequency, KHz	245 $\pm$ 25	215-250	275 $\pm$ 25	275 $\pm$ 25	215 $\pm$ 15
ENVIRONMENTAL					
Operating temperature range, no baseplate with derating, $^{\circ}$ C (see Derating curves)	-40 to +85 with derating				
Storage temperature range, $^{\circ}$ C	-55 to +125				
Maximum baseplate operating temperature, $^{\circ}$ C	+100				
Thermal protection/shutdown, $^{\circ}$ C	+120				
Relative humidity	to +85 $^{\circ}$ C/85% non-condensing				
PHYSICAL					
Outline dimensions	See mechanical specs				
Pin material	Copper alloy				
Pin Finish	Nickel underplate with gold overplate (see mechanical specs for details)				
Pin diameter, inches	0.04/0.062				
Pin diameter, mm	1.016/1.575				
Weight, ounces	0.7				
Weight, grams	20				
Electromagnetic interference (conducted)	Meets EN55022 and CISPR22 class B with external filter.				
Safety	Meets UL/cUL 60950-1, CSA-C22.2 No.60950-1, IEC/EN 60950-1				

FUNCTIONAL SPECIFICATIONS, Q48 MODELS				
	UWE-3.3/20-Q48	UWE-5/15-Q48	UWE-12/6-Q48	UWE-15/5-Q48
Specs are typical unless noted.				
INPUT				
Input voltage range	See ordering guide			
Start-up threshold, Volts	17.5	17.5	17.5	17.5
Undervoltage shutdown, V. (@ 1/2 load)	16.5	16.0	16.0	16.0
Overvoltage shutdown, V.	none			
Reflected (back) ripple current, mA pk-pk	30	30	40	40
Suggested external fast blow fuse, A	8	10	10	20
Input current				
Full load conditions				
Inrush transient, A <sup>2</sup> sec	0.1 A <sup>2</sup> sec	0.1 A <sup>2</sup> sec	0.1 A <sup>2</sup> sec	0.1 A <sup>2</sup> sec
Input current if output is in short circuit, mA	150	250	100	250
No load, mA	75	90	90	90
Low line (Vin=min.), Amps	4.1	4.6	4.35	4.71
Standby mode, mA	4	5	4	5
(Off, UV, OT shutdown) Internal input filter type	Pi-type	L-C	Pi-type	L-C
Reverse polarity protection	None, install external fuse			
Remote On/Off control				
Positive logic ("P" model suffix)	OFF = Ground pin to +0.8V max.			
	ON = Open pin or +3.5V to +15V max.			
Negative logic ("N" model suffix)	OFF = Open pin or +5V to +15V max.			
	ON = Ground pin to +1V max.			
Current, mA	1			

FUNCTIONAL SPECIFICATIONS, Q48 MODELS, CONTINUED				
OUTPUT	UWE-3.3/20-Q48	UWE-5/15-Q48	UWE-12/6-Q48	UWE-15/5-Q48
Voltage output range	See ordering guide			
Voltage output accuracy	±1% of Vnom., (50% load)			
Adjustment range	-10 to +10% of Vnom.			
Temperature coefficient	±0.02% of Vout range per °C			
Minimum loading	No minimum load			
Remote sense compensation	+10% max.			
Ripple/noise (20 MHz bandwidth)	See ordering guide			
Line/Load regulation	See ordering guide			
Efficiency	See ordering guide			
Maximum capacitive loading, $\mu\text{F}$ low ESR <0.02 $\Omega$ max., resistive load	4,700	10,000	4,700	3300
<b>Isolation voltage</b>				
Input to Output, Volts min. DC	2250			
Input to baseplate, Volts min. DC	1500			
Baseplate to output, Volts min. DC	750			
Isolation resistance, M $\Omega$	100			
Isolation capacitance, pF	1000	1500	1000	1000
Isolation safety rating	Basic insulation			
Current limit inception (98% of Vout, after warmup), Amps	26.5	21.0	8.0	7.05
Short circuit protection method	Current limiting, hiccup autorestart. Remove overload for recovery.			
Short circuit current, Amps	5.0	1.5	1.0	1.5
Short circuit duration	Continuous, output shorted to ground. No damage.			
Overvoltage protection, Volts (via magnetic feedback)	4	6.5	15	18
<b>DYNAMIC CHARACTERISTICS</b>				
Dynamic load response, $\mu\text{Sec}$ (50-75-50% load step) to final value	50 (to $\pm 2\%$ )	50 (to $\pm 2\%$ )	50 (to $\pm 1\%$ )	50 (to $\pm 1\%$ )
<b>Start-up time</b>				
Vin to Vout regulated, mSec	20	20	30	30
Remote On/Off to Vout regulated, mSec	10	20	20	25
Switching frequency, KHz	215 $\pm$ 20	240 $\pm$ 20	220 $\pm$ 20	225 $\pm$ 25
<b>ENVIRONMENTAL</b>				
Operating temperature range, no baseplate with derating, °C (see Derating curves)	-40 to +85 with derating			
Storage temperature range, °C	-55 to +125			
Maximum baseplate operating temperature, °C	+100	+105	+100	+105
Thermal protection/shutdown, °C	+120	+120	+120	+120
Relative humidity	to +85°C/85% non-condensing			
<b>PHYSICAL</b>				
Outline dimensions	See mechanical specs			
Pin material	Copper alloy			
Pin Finish	Nickel underplate with gold overplate (see mechanical specs for details)			
Pin diameter, inches	0.04/0.062			
Pin diameter, mm	1.016/1.575			
Weight, ounces	0.7			
Weight, grams	20			
Electromagnetic interference (conducted)	Meets EN55022 and CISPR22 class B with external filter.			
Safety	Certified to UL/cUL 60950-1, CSA-C22.2 No.60950-1, IEC/EN 60950-1, 2nd Edition			

CALCULATED MTBF (TELCORDIA SR-332 METHOD, SEE NOTE 4A)	
Model	Hours
UWE-3.3/20-Q12	1,248,001
UWE-5/15-Q12	1,847,009
UWE-5/15-Q48	2,273,212
UWE-12/6-Q12	3,755,203
UWE-12/6-Q48	5,750,120
UWE-15/5-Q48	2,386,165
UWE-24/3-Q12	3,294,026
CALCULATED MTBF (MIL-HDBK-217N2 METHOD, SEE NOTE 4B)	
UWE-3.3/20-Q12	1,089,141
UWE-5/15-Q12	1,936,627
UWE-5/15-Q48	1,657,518
UWE-12/6-Q12	1,239,521
UWE-12/6-Q48	828,714
UWE-15/5-Q48	2,112,625
UWE-24/3-Q12	2,623,370

Absolute Maximum Ratings	
<b>Input Voltage</b>	
Q12 Models - Volts, max. continuous	0-36 VDC
Volts, transient, 100 mSec	0-50 VDC
Q48 Models - Volts, max. continuous	0-75 VDC
Volts, transient, 100 mSec	0-100 VDC
<b>On/Off Control</b>	
	-0.7 V. min to +15V max.
<b>Input Reverse Polarity Protection</b>	
	See Fuse section.
<b>Output Overvoltage</b>	
	Vout nom. +20% max.
<b>Output Current (Note 7)</b>	
	Current-limited. Devices can withstand sustained short circuit without damage.
<b>Overtemperature Protection</b>	
	Device includes electronic over-temperature shutdown protection under normal operation.
	-55 to +125° C.
<b>Storage Temperature</b>	
<b>Lead Temperature</b>	
	See soldering specifications

Absolute maximums are stress ratings. Exposure of devices to greater than any of these conditions may adversely affect long-term reliability. Proper operation under conditions other than those listed in the Performance/Functional Specifications Table is not implied or recommended.

### SPECIFICATION NOTES

- CAUTION: This product is not internally fused. To comply with safety agency certifications and to avoid injury to personnel or equipment, the user must supply an external fast-blow fuse to the input terminals. See fuse information.
- All Q12 models are tested and specified with external 1µF and 10µF paralleled ceramic/tantalum output capacitors and a 100µF external input capacitor. Q48 models test with a 35µF input cap. All capacitors are low ESR types. Contact Murata Power Solutions for details. These capacitors are necessary to accommodate our test equipment and may not be required to achieve specified performance in your applications. However, Murata Power Solutions recommends using these capacitors in your application. All models are stable and regulate within spec under no-load conditions.  
All specifications are typical unless noted. General conditions for Specifications are +25° C, Vin=nominal, Vout=nominal, full load. Adequate airflow must be supplied for extended testing under power.
  - Input Ripple Current is tested and specified over a 5 Hz to 20 MHz bandwidth. Input filtering is Cin=33 µF, Cbus=220 µF, Lbus=12 µH.
  - Note that Maximum Power Derating curves indicate an average current at nominal input voltage. At higher temperatures and/or lower airflow, the DC-DC converter will tolerate brief full current outputs if the total RMS current over time does not exceed the Derating curve. All Derating curves are presented at sea level altitude. Be aware that power dissipation degrades as altitude increases.
  - Mean Time Before Failure is calculated using the Telcordia (Belcore) SR-332 Method 1, Case 3, ISSUE 2, ground fixed controlled conditions, Tambient=+25°C, full output load, natural air convection.
  - Mean Time Before Failure is calculated using MIL-HDBK-217F, GB ground benign, Tambient=+25°C, full output load, natural air convection.
  - The Remote On/Off Control is normally controlled by a switch or open collector or open drain transistor. But it may also be driven with external logic or by applying appropriate external voltages which are referenced to Input Common.
  - Short circuit shutdown begins when the output voltage degrades approximately 2% from the selected setting.
  - The outputs are not intended to sink appreciable reverse current.
  - Output noise may be further reduced by adding an external filter. See I/O Filtering and Noise Reduction. Larger caps (especially low-ESR ceramic capacitors) may slow transient response or degrade stability. Use only as much output filtering as needed to achieve your noise requirements and no more. Thoroughly test your system under full load with all components installed.
  - All models are fully operational and meet published specifications, including “cold start” at -40° C. At full power, the package temperature of all on-board components must not exceed +128° C.
  - Regulation specifications describe the deviation as the line input voltage or output load current is varied from a nominal midpoint value to either extreme.
  - If the user adjusts the output voltage, accuracy is dependent on user-supplied trim resistors. To achieve high accuracy, use ±1% or better tolerance metal-film resistors. If no trim is installed, the converter will achieve its rated accuracy. Do not exceed maximum power specifications when adjusting the output trim.
  - Output current limit and short circuit protection is non-latching. When the overcurrent fault is removed, the converter will immediately recover.
  - Alternate pin length and/or other output voltages may be available under special quantity order.
  - At zero output current, the output may contain low frequency components which exceed the ripple specification. The output may be operated indefinitely with no load.
  - Input Fusing: If the input voltage is reversed, a body diode will conduct considerable current. Therefore, install an external protection fuse. To ensure reverse input protection with full output load, always connect an external input fast-blow *fuse* in series with the +Vin input. Use approximately twice the full input current rating at the selected input voltage.
  - “Hiccup” overcurrent operation repeatedly attempts to restart the converter with a brief, full-current output. If the overcurrent condition still exists, the restart current will be removed and then tried again. This short current pulse prevents overheating and damaging the converter. Once the fault is removed, the converter immediately recovers normal operation.
  - Note that the converter will operate up to the rated baseplate maximum temperature with the baseplate installed and properly heat sunk. To avoid thermal self-protection shutdown, do not exceed this maximum baseplate temperature.
  - UWE-24/3-Q12 undervoltage shutdown of 8.0V is at half load.
  - UWE-24/3-Q12 output overvoltage protection requires 0.3A minimum load.
  - Pre-bias operation: Startup will succeed if the output setpoint voltage is higher than the pre-existing external output voltage.

**PERFORMANCE DATA**

**UWE-3.3/20-Q12N**

Efficiency vs. Line Voltage and Load Current @ 25°C

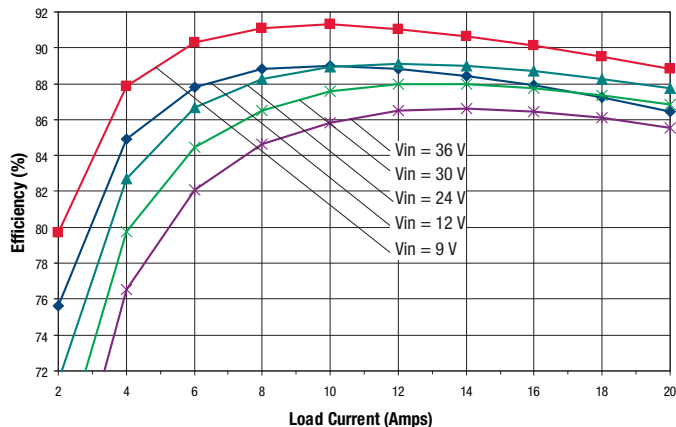

Maximum Current Temperature Derating @ sea level  
(Vin = 12V, transverse airflow, no baseplate)

**UWE-3.3/20-Q12N**

Maximum Current Temperature Derating @ sea level  
(Vin = 12V, transverse airflow, with baseplate)

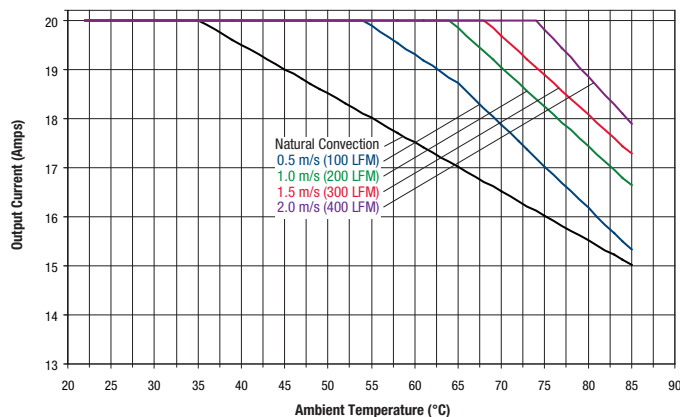
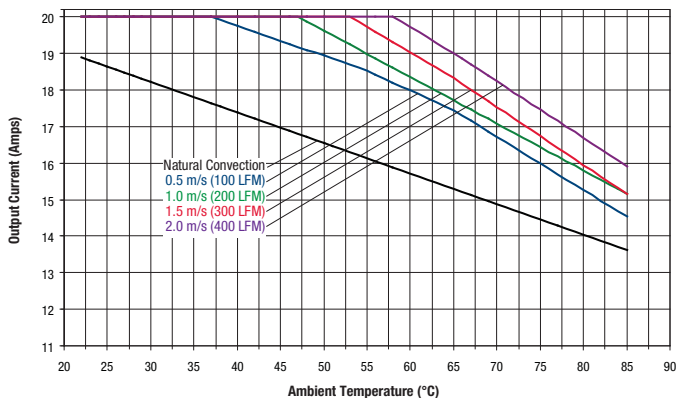

**UWE-3.3/20-Q12N**

Maximum Current Temperature Derating @ sea level  
(Vin = 24V, transverse airflow, with baseplate)

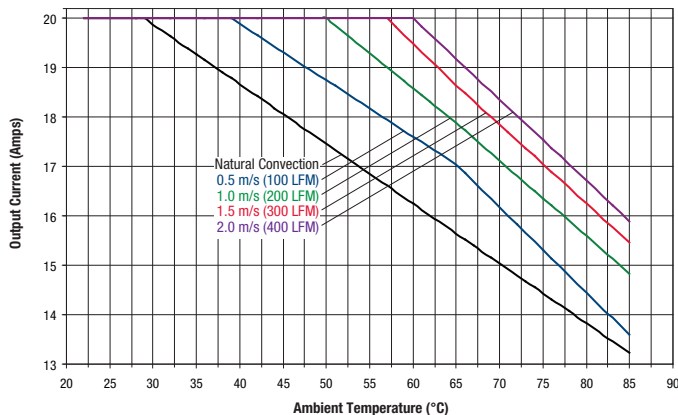

**PERFORMANCE DATA**

**UWE-3.3/20-Q48P**

Efficiency vs. Line Voltage and Load Current @ 25°C

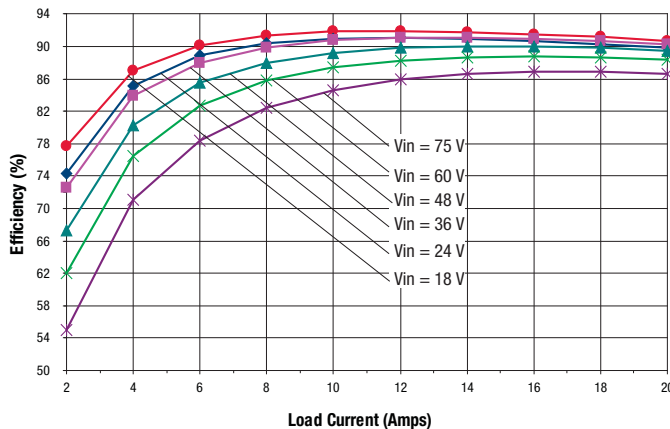

Maximum Current Temperature Derating @ sea level  
(VIN = 24V, transverse airflow, no baseplate)

**UWE-3.3/20-Q48P**

Maximum Current Temperature Derating @sea level  
(VIN = 24V, transverse airflow, with baseplate)



Maximum Current Temperature Derating @ sea level  
(VIN = 48V, transverse airflow, no baseplate)

**UWE-3.3/20-Q48P**

Maximum Current Temperature Derating @sea level  
(VIN = 48V, transverse airflow, with baseplate)

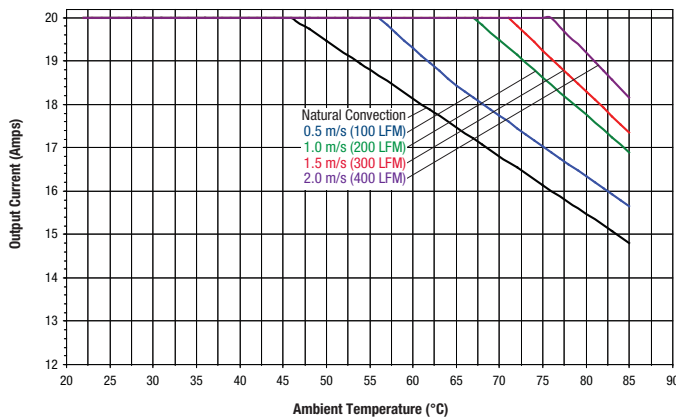
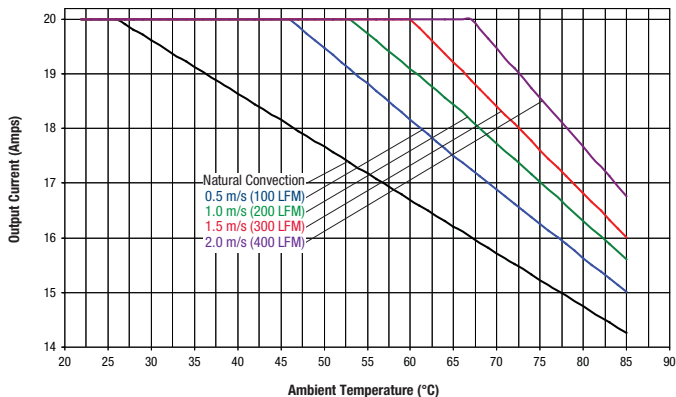



**PERFORMANCE DATA**

**UWE-5/15-Q12N**

Efficiency vs. Line Voltage and Load Current @ 25°C

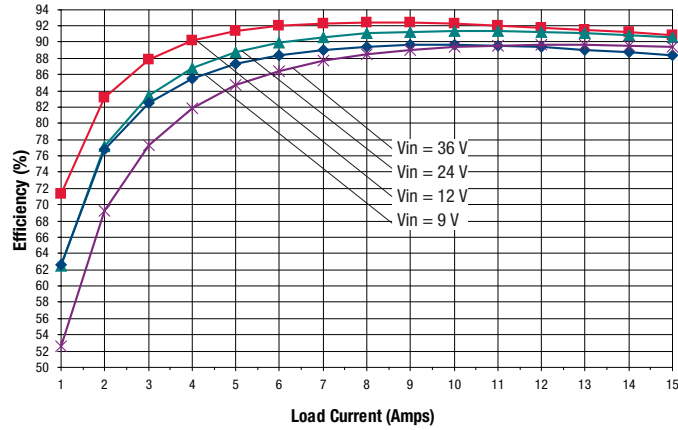

Maximum Current Temperature Derating @ sea level  
(VIN = 12V, transverse airflow, no baseplate)

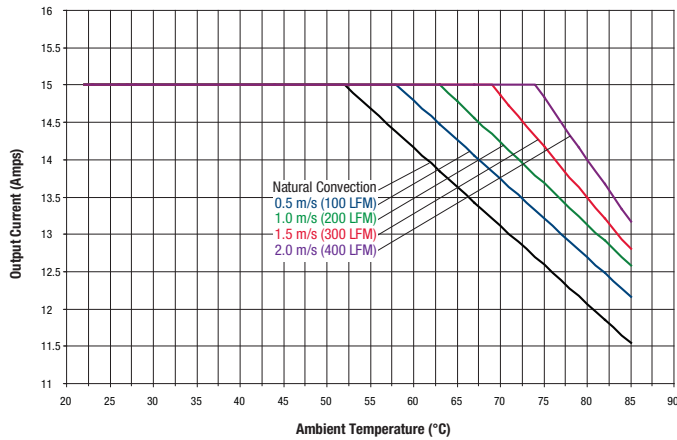

**UWE-5/15-Q12N**

Maximum Current Temperature Derating @ sea level  
(VIN = 12V, transverse airflow, with baseplate)

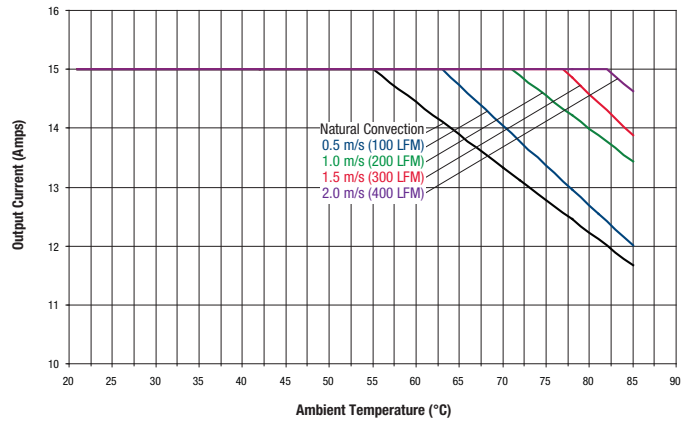

**PERFORMANCE DATA**

**UWE-5/15-Q48P**

Efficiency vs. Line Voltage and Load Current @ 25°C

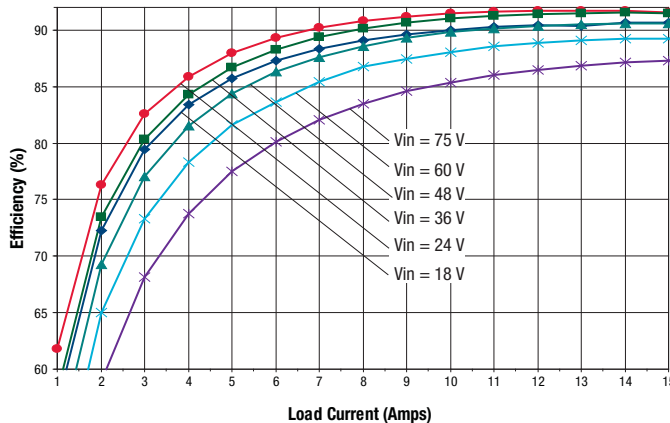

Maximum Current Temperature Derating @ sea level  
( $V_{IN} = 24V$ , transverse airflow, no baseplate)

**UWE-5/15-Q48N**

Maximum Current Temperature Derating @sea level  
( $V_{IN} = 24V$ , transverse airflow, with baseplate)

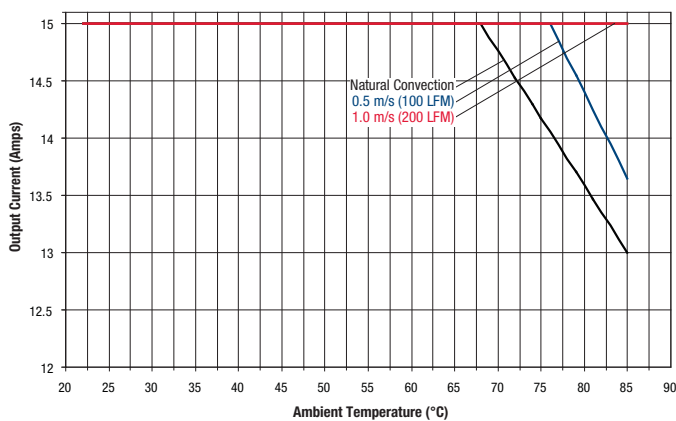
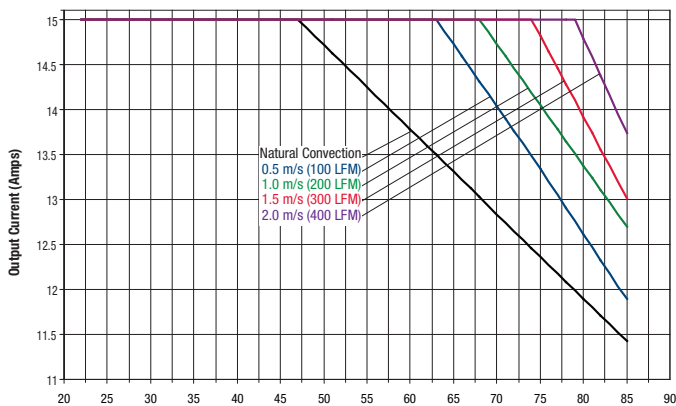

**UWE-5/15-Q48N**

Maximum Current Temperature Derating @ sea level  
( $V_{IN} = 48V$ , transverse airflow, no baseplate)

Maximum Current Temperature Derating @sea level  
( $V_{IN} = 48V$ , transverse airflow, with baseplate)

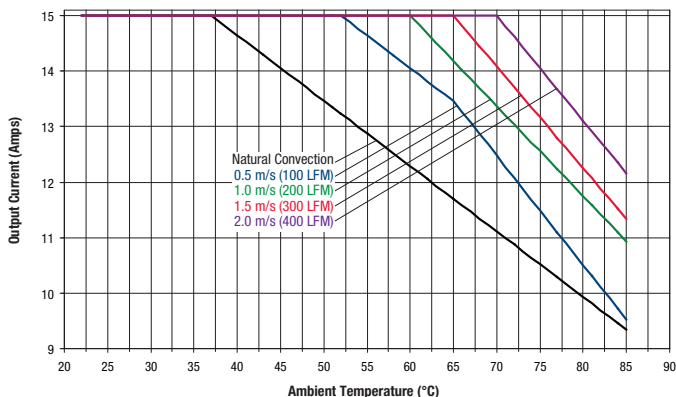

## PERFORMANCE DATA

### UWE-12/6-Q12N

Efficiency vs. Line Voltage and Load Current @ 25°C

Power Dissipation vs. Load Current @ 25°C

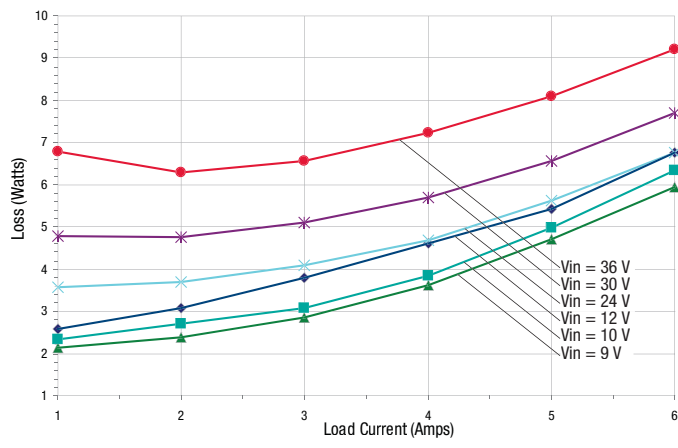
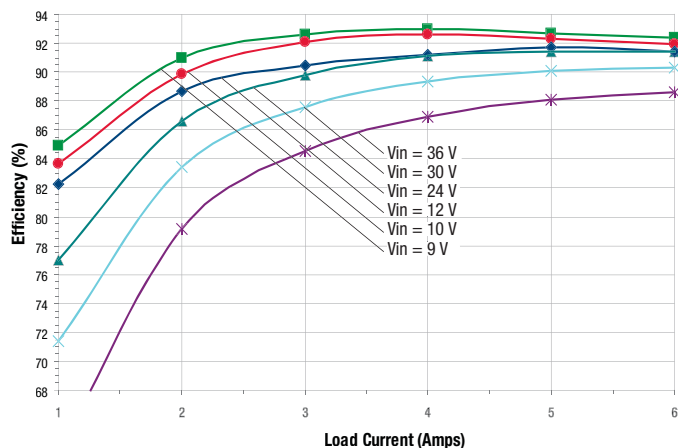

Maximum Current Temperature Derating @ sea level  
( $V_{IN} = 12V$ , transverse airflow, no baseplate)

### UWE-12/6-Q12N

Maximum Current Temperature Derating @ sea level  
( $V_{IN} = 12V$ , transverse airflow, with baseplate)

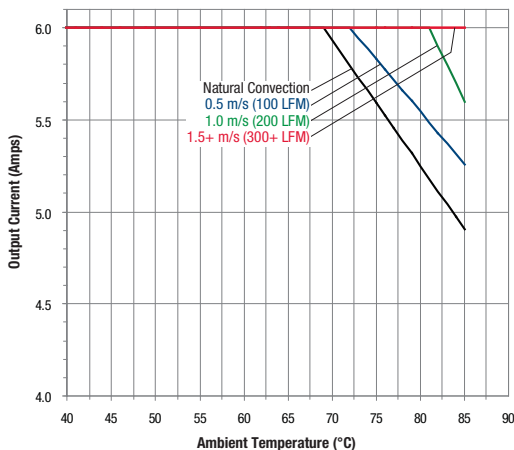
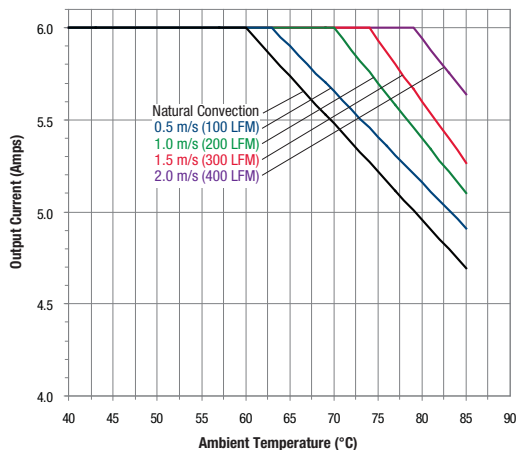

### UWE-12/6-Q48P

Efficiency vs. Line Voltage and Load Current @ 25°C

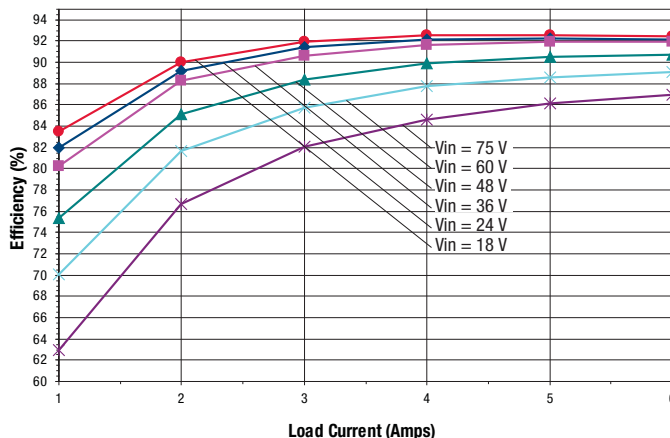

**PERFORMANCE DATA**

**Maximum Current Temperature Derating @ sea level**  
( $V_{IN} = 24V$ , transverse airflow, no baseplate)

**UWE-12/6-Q48P**

**Maximum Current Temperature Derating @sea level**  
( $V_{IN} = 24V$ , transverse airflow, with baseplate)

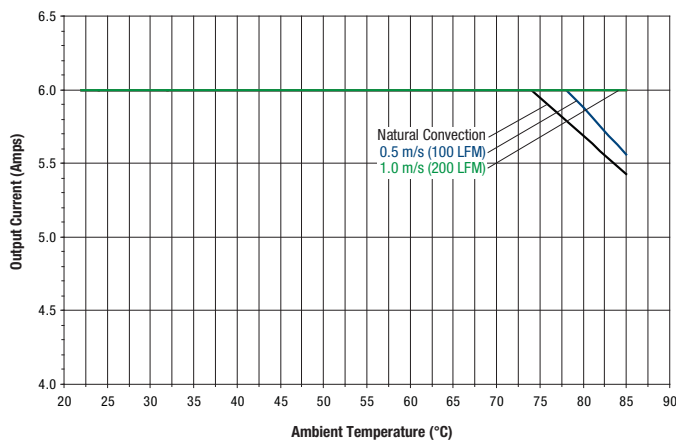
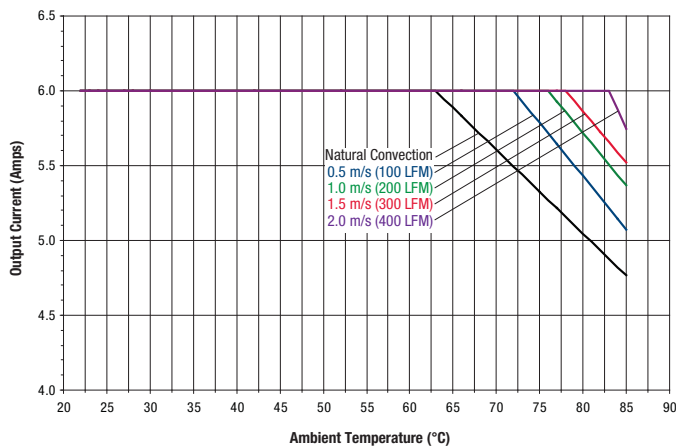

**Maximum Current Temperature Derating @ sea level**  
( $V_{IN} = 48V$ , transverse airflow, no baseplate)

**UWE-12/6-Q48P**

**Maximum Current Temperature Derating @sea level**  
( $V_{IN} = 48V$ , transverse airflow, with baseplate)

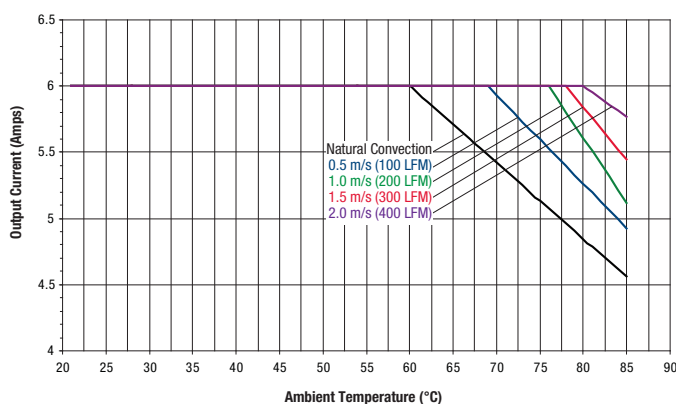
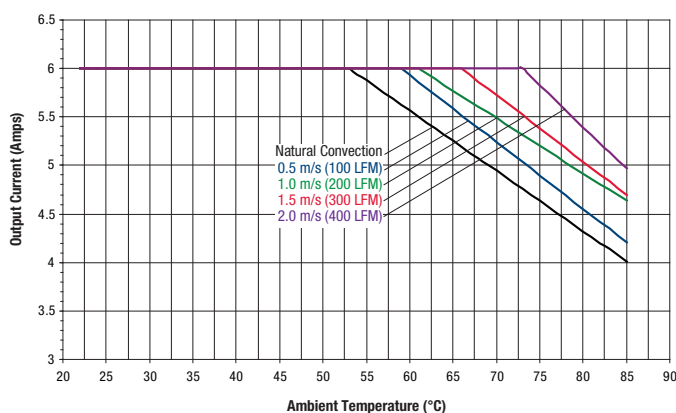

**UWE-15/5-Q12P**

**Efficiency vs. Line Voltage and Load Current @ 25°C**

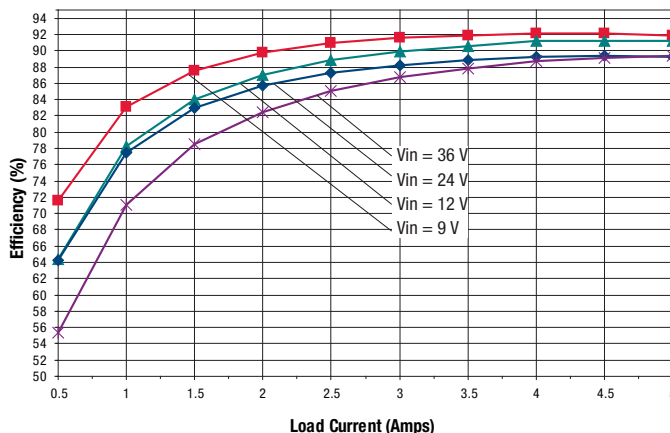

**PERFORMANCE DATA**

**UWE-15/5-Q12N**

Maximum Current Temperature Derating @ sea level  
( $V_{IN} = 12V$ , transverse airflow, no baseplate)

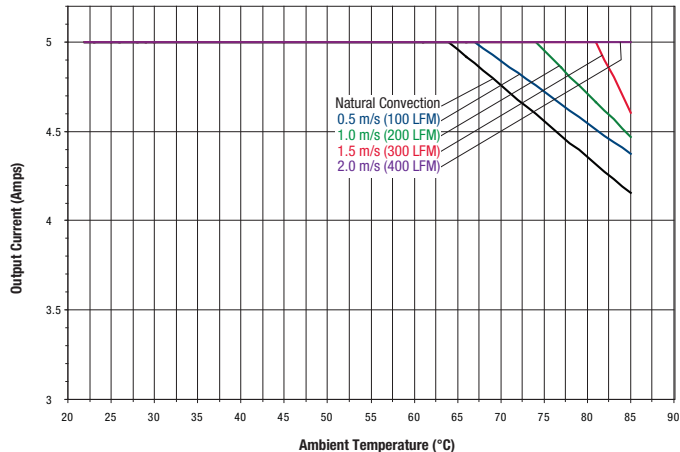

Maximum Current Temperature Derating @sea level  
( $V_{IN} = 12V$ , transverse airflow, with baseplate)

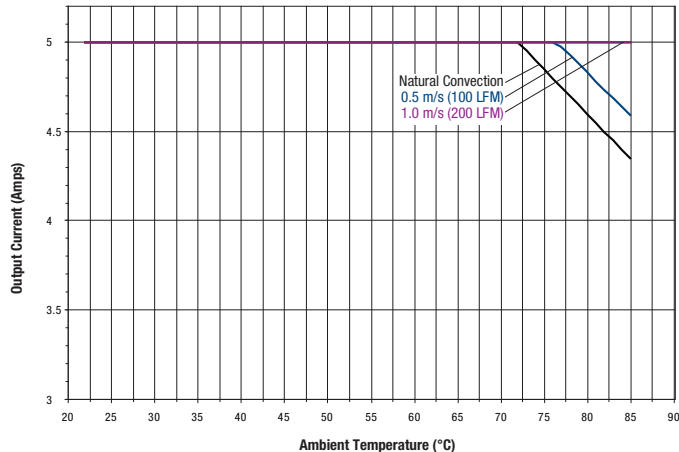

**UWE-15/5-Q12N**

Maximum Current Temperature Derating @ sea level  
( $V_{IN} = 24V$ , transverse airflow, no baseplate)

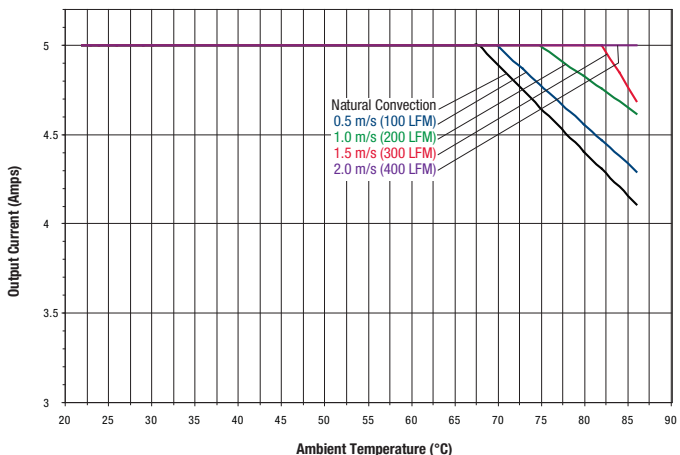

Maximum Current Temperature Derating @sea level  
( $V_{IN} = 24V$ , transverse airflow, with baseplate)

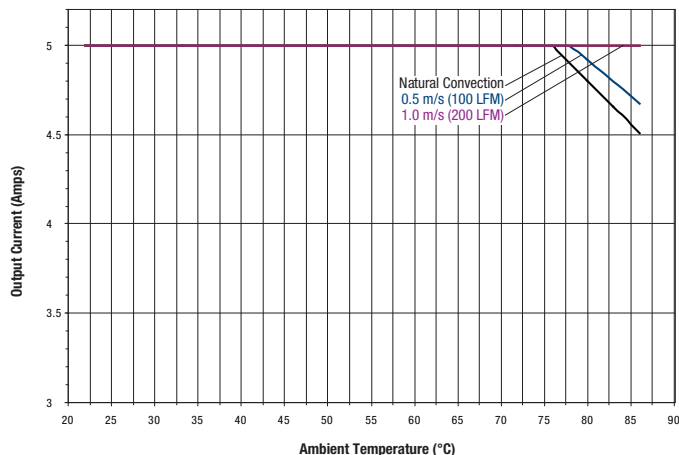

**UWE-15/5-Q48**

Efficiency vs. Line Voltage and Load Current @ 25°C

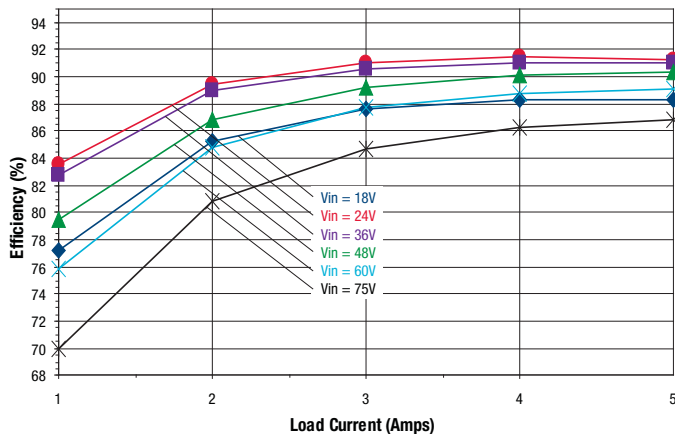

**PERFORMANCE DATA**

**UWE-15/5-Q48**

Power Dissipation vs. Load Current @ 25°C

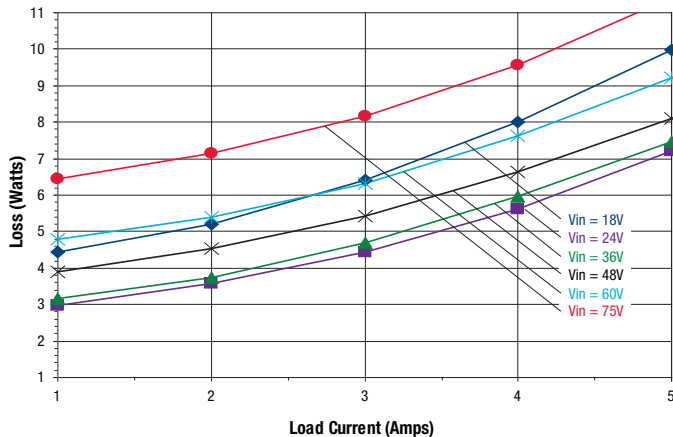

Maximum Current Temperature Derating @sea level  
(Vin = 24V, air flow from Pin 1 to Pin 3 on PCB, with Baseplate)

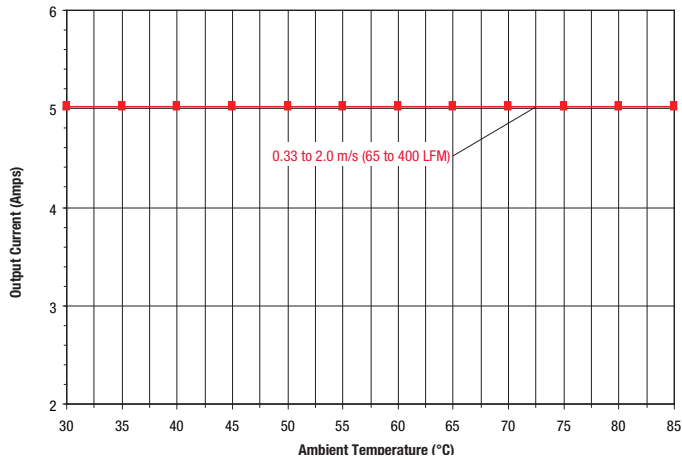

**UWE-15/5-Q48**

Maximum Current Temperature Derating @ sea level  
(Vin = 48V, air flow from Pin 1 to Pin 3 on PCB, with Baseplate)

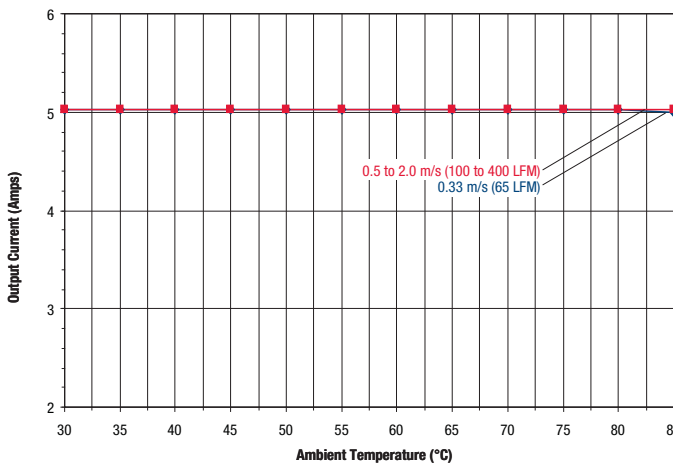

Maximum Current Temperature Derating @sea level  
(Vin = 60V, air flow from Pin 1 to Pin 3 on PCB, with Baseplate)

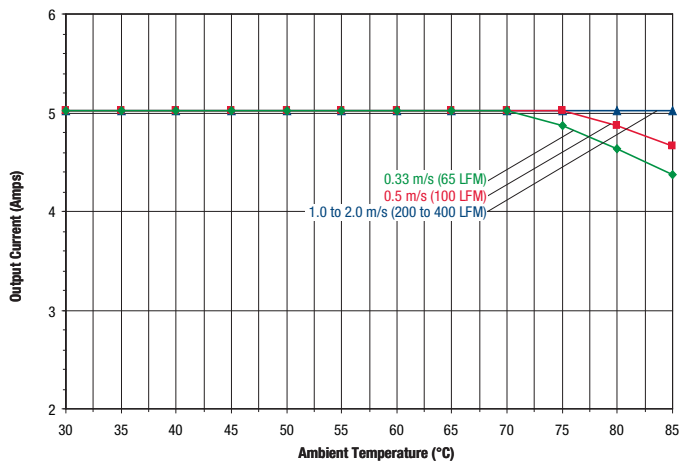

**UWE-15/5-Q48**

Maximum Current Temperature Derating @ sea level  
(Vin = 48V, air flow from Pin 1 to Pin 3 on PCB, no baseplate)

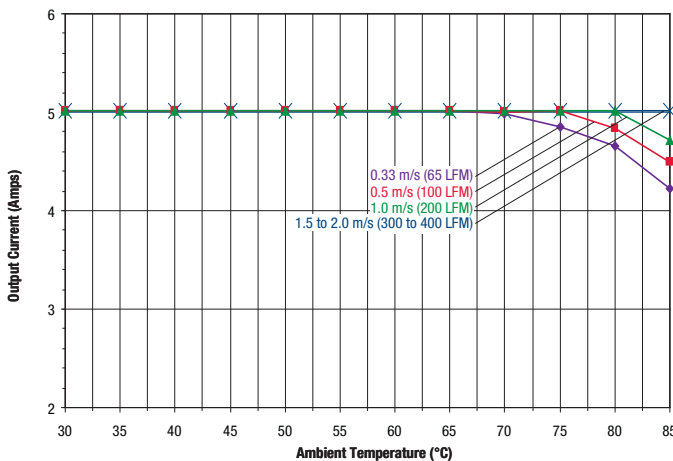

Maximum Current Temperature Derating @sea level  
(Vin = 60V, air flow from Pin 1 to Pin 3 on PCB, no baseplate)

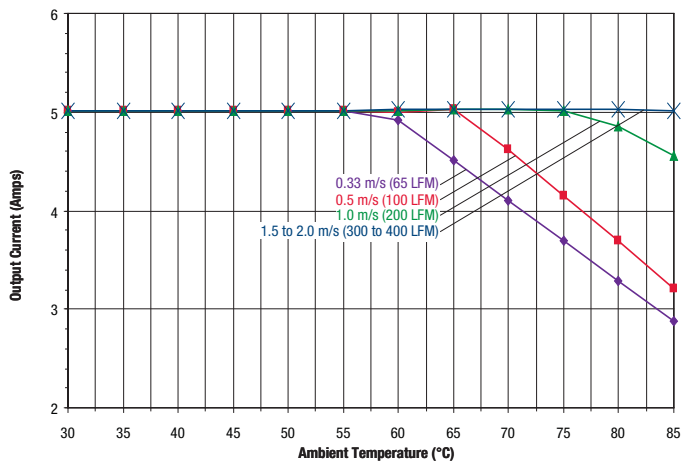

**PERFORMANCE DATA**

**UWE-24/3-Q12P**

Efficiency vs. Line Voltage and Load Current @ 25°C



Power Dissipation vs. Load Current @ 25°C

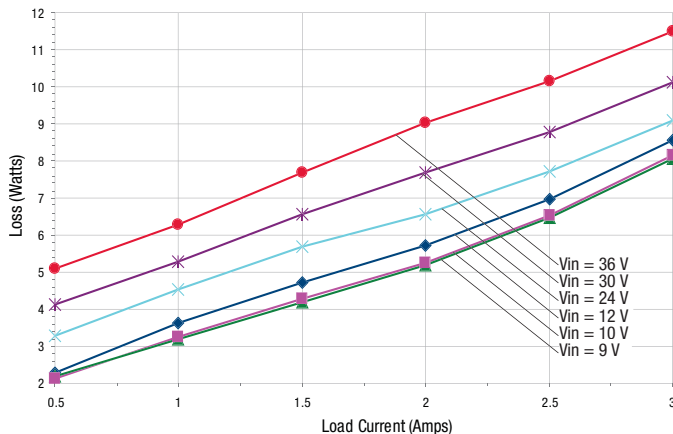

Maximum Current Temperature Derating @ sea level  
( $V_{IN} = 12V$ , transverse airflow, no baseplate)



**UWE-24/3-Q12P**

Maximum Current Temperature Derating @sea level  
( $V_{IN} = 12V$ , transverse airflow, with baseplate)



Maximum Current Temperature Derating @ sea level  
( $V_{IN} = 24V$ , transverse airflow, no baseplate)



**UWE-24/3-Q12N**

Maximum Current Temperature Derating @sea level  
( $V_{IN} = 24V$ , transverse airflow, with baseplate)



**MECHANICAL SPECIFICATIONS—NO BASEPLATE**

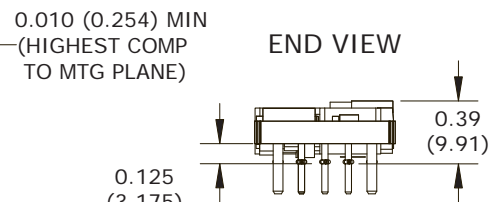
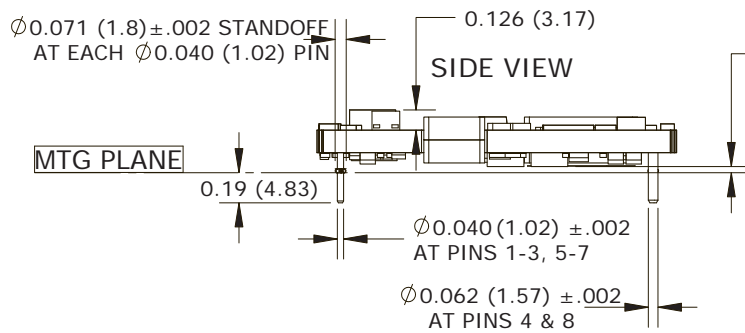
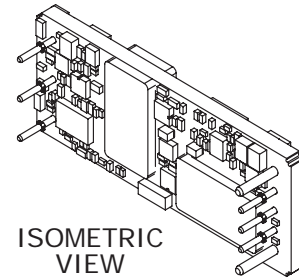
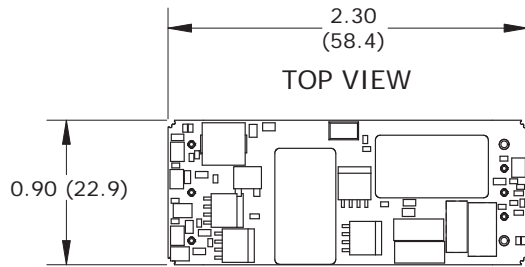

DOSA-Compatible I/O Connections	
Pin	Function
1	+Vin
2	On/Off Control*
3	-Vin
4	-Vout
5	-Sense
6	Trim
7	+Sense
8	+Vout

\* The Remote On/Off can be provided with either positive (P suffix) or negative (N suffix) logic.

Connect each sense input to its respective Vout if sense is not connected at a remote load.

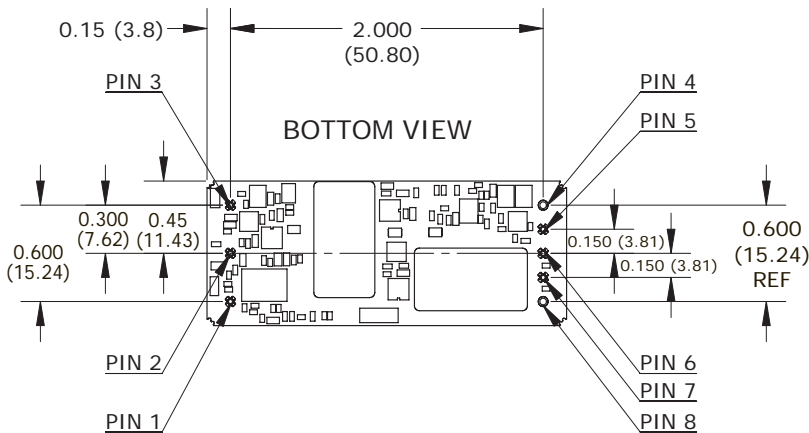

**MATERIAL:**  
 $\phi$ .040 PINS: C26000 BRASS, 3/4 HARD  
 $\phi$ .062 PINS: C10200 COPPER ALLOY, FULL HARD

**FINISH: (ALL PINS)**  
 GOLD (5 MICROINCHES MIN) OVER NICKEL (50 MICROINCHES MIN)

Dimensions are in inches (mm) shown for ref. only.

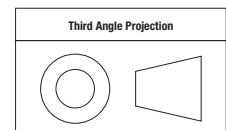

Tolerances (unless otherwise specified):  
 .XX ± 0.02 (0.5)  
 .XXX ± 0.010 (0.25)  
 Angles ± 2°

Components are shown for reference only.



**MECHANICAL SPECIFICATIONS (continued)—BASEPLATE INSTALLED**

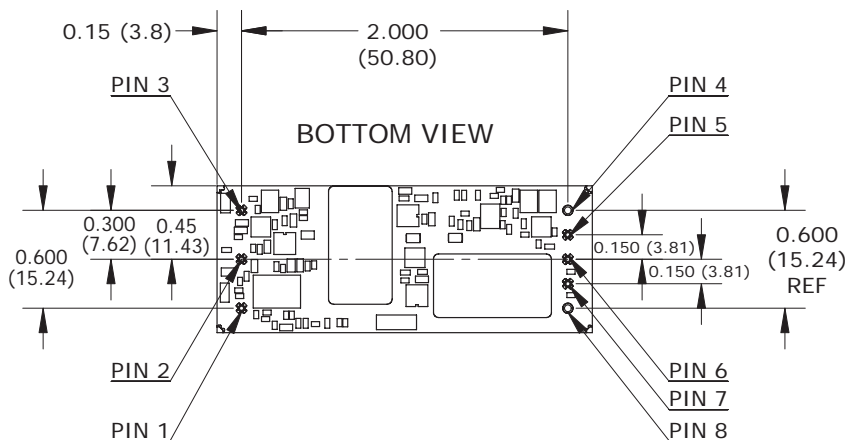
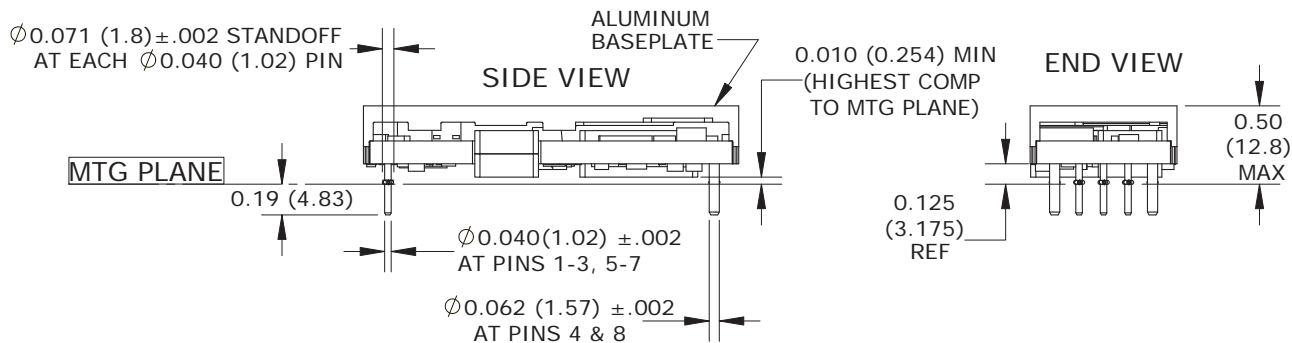
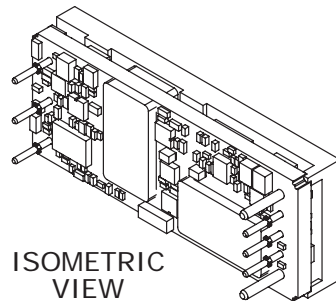

**MATERIAL:**  
 Ø .040 PINS: C26000 BRASS, 3/4 HARD  
 Ø .062 PINS: C10200 COPPER ALLOY, FULL HARD

**FINISH: (ALL PINS)**  
 GOLD (5 MICROINCHES MIN) OVER NICKEL (50 MICROINCHES MIN)

Dimensions are in inches (mm) shown for ref. only.

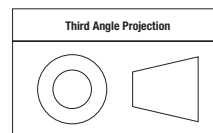

Tolerances (unless otherwise specified):  
 .XX ± 0.02 (0.5)  
 .XXX ± 0.010 (0.25)  
 Angles ± 2°

Components are shown for reference only.

**SHIPPING TRAYS AND BOXES**

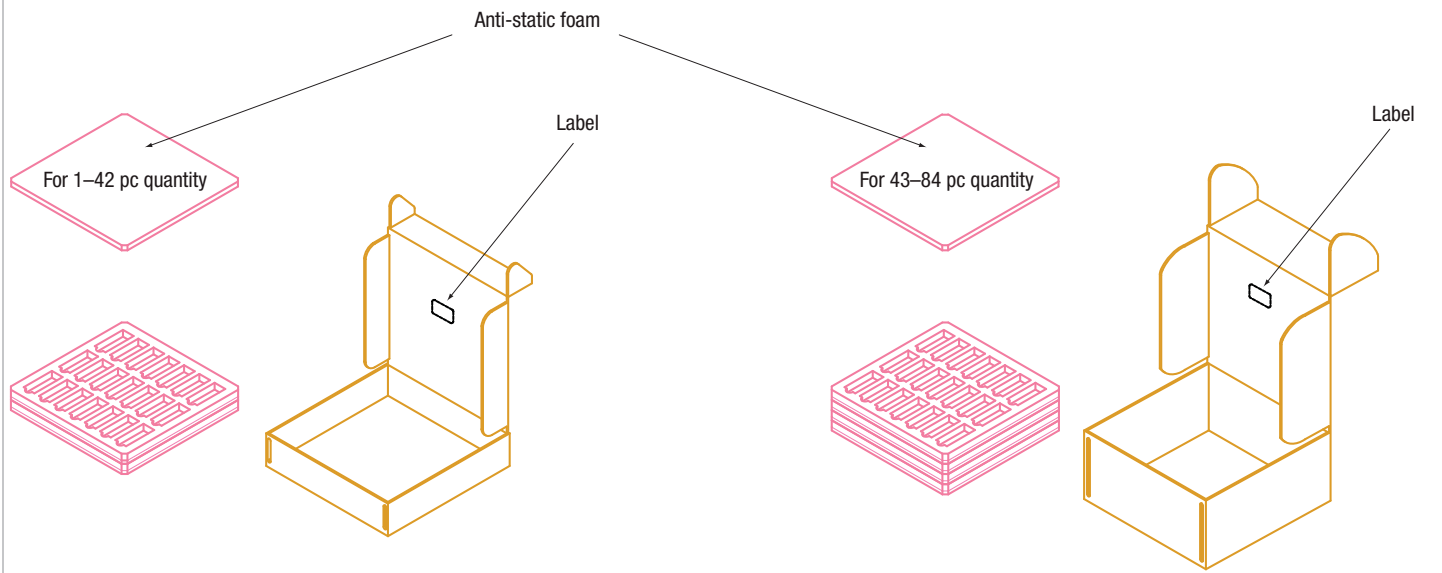

**SHIPPING TRAY**

UWE modules are supplied in a 21-piece (3-by-7) shipping tray. The tray is an anti-static closed-cell polyethylene foam. Dimensions are shown below.

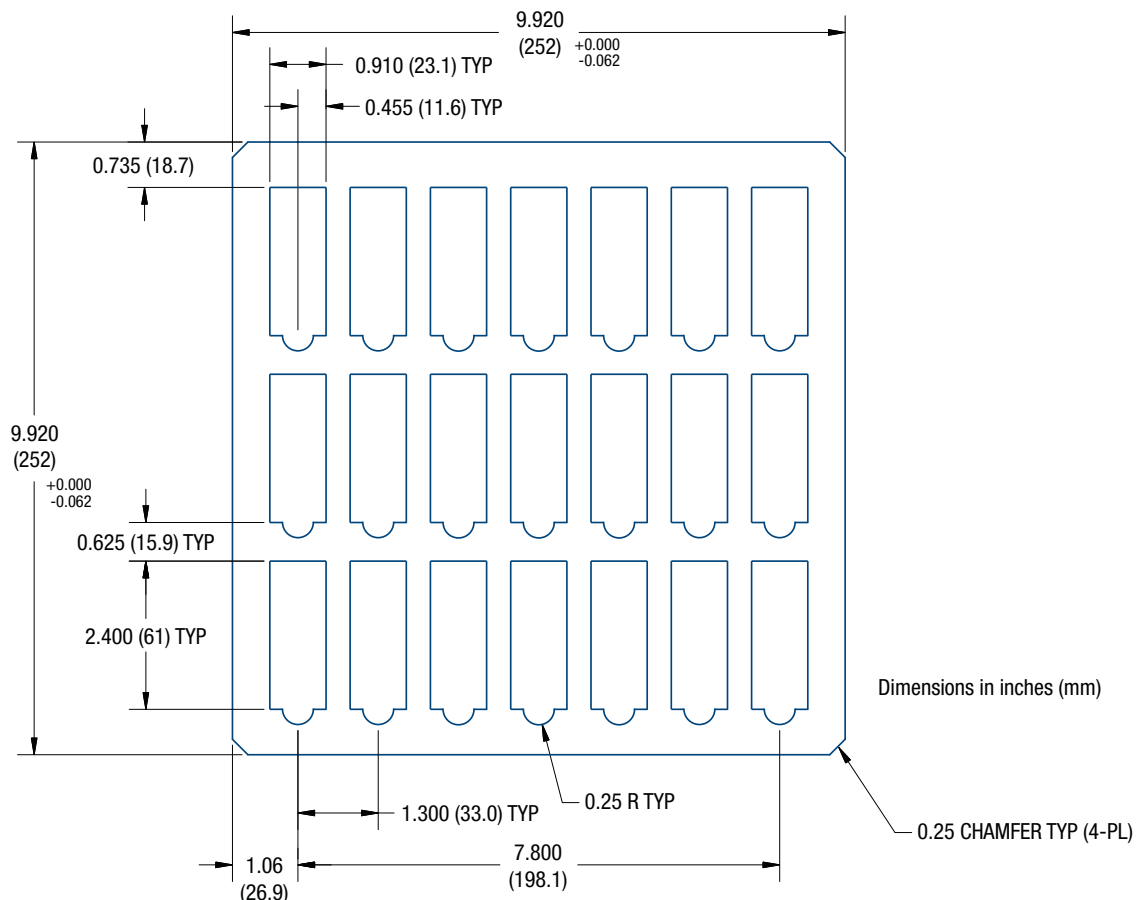

**TECHNICAL NOTES**

**Soldering Guidelines**

Murata Power Solutions recommends the specifications below when installing these converters. These specifications vary depending on the solder type. Exceeding these specifications may cause damage to the product. Your production environment may differ; therefore please thoroughly review these guidelines with your process engineers.

**Wave Solder Operations for through-hole mounted products (THMT)**

**For Sn/Ag/Cu based solders:**

Maximum Preheat Temperature	115° C.
Maximum Pot Temperature	270° C.
Maximum Solder Dwell Time	7 seconds

**For Sn/Pb based solders:**

Maximum Preheat Temperature	105° C.
Maximum Pot Temperature	250° C.
Maximum Solder Dwell Time	6 seconds

**Input Fusing**

Certain applications and/or safety agencies may require the installation of fuses at the inputs of power conversion components. Fuses should also be used if the possibility of sustained, non-current-limited, input-voltage polarity reversals exist. For MPS UWE DC-DC Converters, you should use fast-blow type fuses, installed in the ungrounded input supply line. Refer to the specifications for fuse values.

All relevant national and international safety standards and regulations must be observed by the installer. For system safety agency approvals, the converters must be installed in compliance with the requirements of the end-use safety standard, e.g., IEC/EN/UL60950-1.

**Input Undervoltage Shutdown and Start-Up Threshold**

Under normal start-up conditions, devices will not begin to regulate until the ramping-up input voltage exceeds the Start-Up Threshold Voltage. Once operating, devices will not turn off until the input voltage drops below the Undervoltage Shutdown limit. Subsequent re-start will not occur until the input is brought back up to the Start-Up Threshold. This built in hysteresis prevents any unstable on/off situations from occurring at a single input voltage.

**Start-Up Time**

The  $V_{IN}$  to  $V_{OUT}$  Start-Up Time is the interval of time between the point at which the ramping input voltage crosses the Start-Up Threshold and the fully loaded output voltage enters and remains within its specified accuracy band. Actual measured times will vary with input source impedance, external input/output capacitance, and load. The UWE Series implements a soft start circuit that limits the duty cycle of its PWM controller at power up, thereby limiting the input inrush current.

The On/Off Control to  $V_{OUT}$  start-up time assumes the converter has its nominal input voltage applied but is turned off via the On/Off Control pin. The specification defines the interval between the point at which the converter is turned on and the fully loaded output voltage enters and remains within its specified accuracy band. Similar to the  $V_{IN}$  to  $V_{OUT}$  start-up, the On/Off Control to  $V_{OUT}$  start-up time is also governed by the internal soft start circuitry and external load capacitance.

The difference in start up time from  $V_{IN}$  to  $V_{OUT}$  and from On/Off Control to  $V_{OUT}$  is therefore insignificant.

**Input Source Impedance**

UWE converters must be driven from a low ac-impedance input source. The DC-DC's performance and stability can be compromised by the use of highly inductive source impedances. For optimum performance, components should be mounted close to the DC-DC converter. If the application has a high source impedance, low  $V_{IN}$  models can benefit from increased external input capacitance.

**I/O Filtering, Input Ripple Current, and Output Noise**

All models in the UWE Converters are tested/specified for input reflected ripple current and output noise using the specified external input/output components/circuits and layout as shown in the following two figures.

External input capacitors ( $C_{IN}$  in Figure 2) serve primarily as energy-storage elements, minimizing line voltage variations caused by transient IR drops in conductors from backplane to the DC-DC. Input caps should be selected for bulk capacitance (at appropriate frequencies), low ESR, and high rms-ripple-current ratings. The switching nature of DC-DC converters requires that dc voltage sources have low ac impedance as highly inductive source impedance can affect system stability. In Figure 2,  $C_{BUS}$  and  $L_{BUS}$  simulate a typical dc voltage bus. Your specific system configuration may necessitate additional considerations.

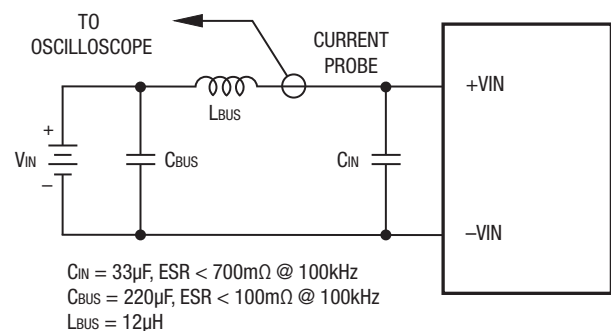

**Figure 2. Measuring Input Ripple Current**

In critical applications, output ripple/noise (also referred to as periodic and random deviations or PARD) may be reduced below specified limits using filtering techniques, the simplest of which is the installation of additional external output capacitors. These output caps function as true filter elements and should be selected for bulk capacitance, low ESR and appropriate frequency response. All external capacitors should have appropriate voltage ratings and be located as close to the converter as possible. Temperature variations for all relevant parameters should also be taken carefully into consideration.

The most effective combination of external I/O capacitors will be a function of line voltage and source impedance, as well as particular load and layout conditions.

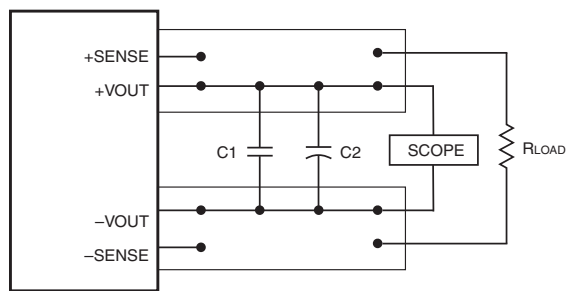

C1 = 0.47µF CERAMIC  
C2 = NA  
LOAD 2-3 INCHES (51-76mm) FROM MODULE

**Figure 3. Measuring Output Ripple/Noise (PARD)**

**Floating Outputs**

Since these are isolated DC-DC converters, their outputs are "floating" with respect to their input. Designers will normally use the -Output as the ground/return of the load circuit. You can, however, use the +Output as ground/return to effectively reverse the output polarity.

**Minimum Output Loading Requirements**

UWE converters employ a synchronous-rectifier design topology and all models regulate within spec and are stable under no-load to full load conditions. Operation under no-load conditions however might slightly increase the output ripple and noise.

**Thermal Shutdown**

These UWE converters are equipped with thermal-shutdown circuitry. If environmental conditions cause the internal temperature of the DC-DC converter to rise above the designed operating temperature, a precision temperature sensor will power down the unit. When the internal temperature decreases below the threshold of the temperature sensor, the unit will self start. See Performance/Functional Specifications.

**Output Overvoltage Protection**

UWE output voltages are monitored for an overvoltage condition via magnetic feedback. The signal is coupled to the primary side and if the output voltage rises to a level which could be damaging to the load, the sensing circuitry will power down the PWM controller causing the output voltages to decrease. Following a time-out period the PWM will restart, causing the output voltages to ramp to their appropriate values. If the fault condition persists, and the output voltages again climb to excessive levels, the overvoltage circuitry will initiate another shutdown cycle. This on/off cycling is referred to as "hiccup" mode.

**Current Limiting**

As soon as the output current increases to substantially above its rated value, the DC-DC converter will go into a current-limiting mode. In this condition, the output voltage will decrease proportionately with increases in output current, thereby maintaining somewhat constant power dissipation. This is commonly referred to as power limiting. Current limit inception is defined as the point at which the full-power output voltage falls below the specified tolerance. See Performance/Functional Specifications. If the load current, being drawn from the converter, is significant enough, the unit will go into a short circuit condition as specified under "Performance."

**Short Circuit Condition**

When a converter is in current-limit mode, the output voltage will drop as the output current demand increases. If the output voltage drops too low, the magnetically coupled voltage used to develop primary side voltages will also drop, thereby shutting down the PWM controller. Following a time-out period, the PWM will restart causing the output voltages to begin ramping to their appropriate values. If the short-circuit condition persists, another shutdown cycle will be initiated. This on/off cycling is referred to as "hiccup" mode. The hiccup cycling reduces the average output current, thereby preventing internal temperatures from rising to excessive levels. The UWE is capable of enduring an indefinite short circuit output condition.

**Features and Options**

**On/Off Control**

The input-side, remote On/Off Control function can be ordered to operate with either logic type:

Positive-logic models ("P" part-number suffix) are enabled when the On/Off Control is left open or is pulled high, as per Figure 4. Positive-logic devices are disabled when the On/Off Control is pulled low.

Negative-logic devices ("N" suffix) are off when the On/Off Control is open (or pulled high), and on when the On/Off Control is pulled low with respect to -VIN as shown in Figure 5.

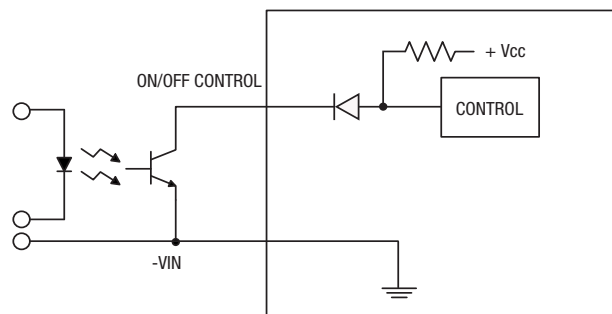

**Figure 4. Driving the Positive Logic On/Off Control Pin**

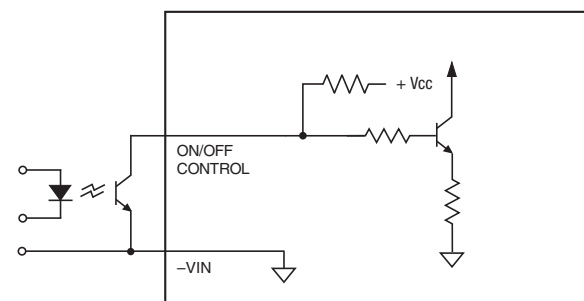

**Figure 5. Driving the Negative Logic On/Off Control Pin**

Dynamic control of the remote on/off function is facilitated with a mechanical relay or an open-collector/open-drain drive circuit (optically isolated if appropriate). The drive circuit should be able to sink appropriate current (see Performance Specs) when activated and withstand appropriate voltage when deactivated. Applying an external voltage to the On/Off Control when no input power is applied to the converter can cause permanent damage to the converter.

**Trimming Output Voltage**

UWE converters have a trim capability that allows users to adjust the output voltages. Adjustments to the output voltages can be accomplished via a trim pot (Figure 6) or a single fixed resistor as shown in Figures 7 and 8. A single fixed resistor can increase or decrease the output voltage depending on its connection. The resistor should be located close to the converter and have a TCR less than 100ppm/°C to minimize sensitivity to changes in temperature. If the trim function is not used, leave the trim pin floating.

A single resistor connected from the Trim to the +Output, or +Sense where applicable, will increase the output voltage in this configuration. A resistor connected from the Trim to the -Output, or -Sense where applicable, will decrease the output voltage in this configuration.

Trim adjustments greater than the specified range can have an adverse affect on the converter's performance and are not recommended. Excessive voltage differences between  $V_{OUT}$  and Sense, in conjunction with trim adjustment of the output voltage, can cause the overvoltage protection circuitry to activate (see Performance Specifications for overvoltage limits). Power derating is based on maximum output current and voltage at the converter's output pins. Use of trim and sense functions can cause output voltages to increase, thereby increasing output power beyond the converter's specified rating or cause output voltages to climb into the output overvoltage region. Therefore:

$$(V_{out \text{ at pins}}) \times (I_{out}) \leq \text{rated output power}$$

**Note:** Resistor values are in  $k\Omega$ . Adjustment accuracy is subject to resistor tolerances and factory-adjusted output accuracy.  $V_0$  = desired output voltage.

**Remote Sense Note:** The Sense and  $V_{OUT}$  lines are internally connected through low value resistors. Nevertheless, if the sense function is not used for remote regulation the user should connect the +Sense to + $V_{OUT}$  and -Sense to - $V_{OUT}$  at the DC-DC converter pins.

UWE series converters have a sense feature to provide point of use regulation, thereby overcoming moderate IR drops in pcb conductors or cabling. The remote sense lines carry very little current and therefore require minimal cross-sectional-area conductors. The sense lines are used by the feedback control-loop to regulate the output. As such, they are not low impedance points and must be treated with care in layouts and cabling. Sense lines on a pcb should be run adjacent to dc signals, preferably ground. In cables and discrete wiring applications, twisted pair or other techniques should be implemented.

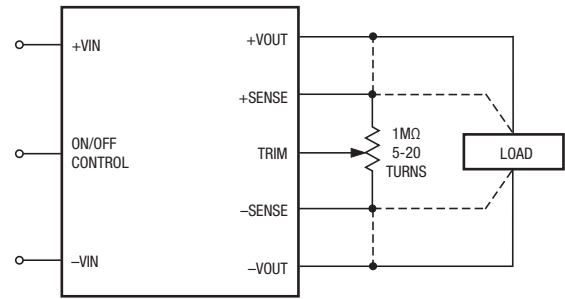

Figure 6. Trim Connections Using A Trimpot

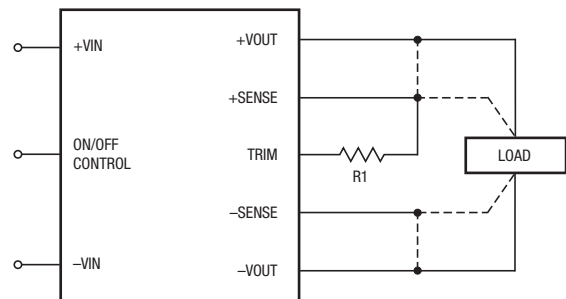

Figure 7. Trim Connections To Increase Output Voltages Using a Fixed Resistor



Figure 8. Trim Connections To Decrease Output Voltages

**Trim Equations**

Trim Up

Trim Down

3.3 Volt Output	
$R_{T\_UP} (k\Omega) = \frac{13.3(V_O - 1.226)}{V_O - 3.3} - 10.2$	$R_{T\_DOWN} (k\Omega) = \frac{16.31}{3.3 - V_O} - 10.2$
5 Volt Output	
$R_{T\_UP} (k\Omega) = \frac{20.4(V_O - 1.226)}{V_O - 5} - 10.2$	$R_{T\_DOWN} (k\Omega) = \frac{25.01}{5 - V_O} - 10.2$
12 Volt Output	
$R_{T\_UP} (k\Omega) = \frac{49.6(V_O - 1.226)}{V_O - 12} - 10.2$	$R_{T\_DOWN} (k\Omega) = \frac{60.45}{12 - V_O} - 10.2$
15 Volt Output	
$R_{T\_UP} (k\Omega) = \frac{62.9(V_O - 1.226)}{V_O - 15} - 10.2$	$R_{T\_DOWN} (k\Omega) = \frac{76.56}{15 - V_O} - 10.2$
24 Volt Output	
$R_{T\_UP} (k\Omega) = \frac{101(V_O - 1.226)}{V_O - 24} - 10.2$	$R_{T\_DOWN} (k\Omega) = \frac{124.2}{24 - V_O} - 10.2$

UWE series converters will compensate for drops between the output voltage at the DC-DC and the sense voltage at the DC-DC provided that:

$$[V_{out(+)} - V_{out(-)}] - [Sense(+) - Sense(-)] \leq 5\% V_{out}$$

Output overvoltage protection is monitored at the output voltage pin, not the Sense pin. Therefore, excessive voltage differences between  $V_{OUT}$  and Sense in conjunction with trim adjustment of the output voltage can cause the overvoltage protection circuitry to activate (see Performance Specifications for overvoltage limits). Power derating is based on maximum output current and voltage at the converter's output pins. Use of trim and sense functions can cause output voltages to increase thereby increasing output power beyond the UWE's specified rating or cause output voltages to climb into the output overvoltage region. Also, the use of Trim Up and Sense combined may not exceed +10% of  $V_{OUT}$ . Therefore, the designer must ensure:

$$(V_{out \text{ at pins}}) \times (I_{out}) \leq \text{rated output power}$$

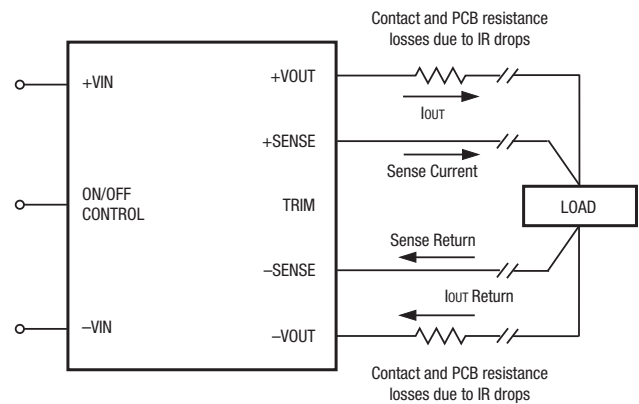

**Figure 9. Remote Sense Circuit Configuration**



Figure 10. Vertical Wind Tunnel

**Vertical Wind Tunnel**

Murata Power Solutions employs a computer controlled custom-designed closed loop vertical wind tunnel, infrared video camera system, and test instrumentation for accurate airflow and heat dissipation analysis of power products. The system includes a precision low flow-rate anemometer, variable speed fan, power supply input and load controls, temperature gauges, and adjustable heating element.

The IR camera monitors the thermal performance of the Unit Under Test (UUT) under static steady-state conditions. A special optical port is used which is transparent to infrared wavelengths.

Both through-hole and surface mount converters are soldered down to a 10" x 10" host carrier board for realistic heat absorption and spreading. Both longitudinal and transverse airflow studies are possible by rotation of this carrier board since there are often significant differences in the heat dissipation in the two airflow directions. The combination of adjustable airflow, adjustable ambient heat, and adjustable Input/Output currents and voltages mean that a very wide range of measurement conditions can be studied.

The collimator reduces the amount of turbulence adjacent to the UUT by minimizing airflow turbulence. Such turbulence influences the effective heat transfer characteristics and gives false readings. Excess turbulence removes more heat from some surfaces and less heat from others, possibly causing uneven overheating.

Both sides of the UUT are studied since there are different thermal gradients on each side. The adjustable heating element and fan, built-in temperature gauges, and no-contact IR camera mean that power supplies are tested in real-world conditions.





Компания «ЭлектроПласт» предлагает заключение долгосрочных отношений при поставках импортных электронных компонентов на взаимовыгодных условиях!

Наши преимущества:

- Оперативные поставки широкого спектра электронных компонентов отечественного и импортного производства напрямую от производителей и с крупнейших мировых складов;
- Поставка более 17-ти миллионов наименований электронных компонентов;
- Поставка сложных, дефицитных, либо снятых с производства позиций;
- Оперативные сроки поставки под заказ (от 5 рабочих дней);
- Экспресс доставка в любую точку России;
- Техническая поддержка проекта, помощь в подборе аналогов, поставка прототипов;
- Система менеджмента качества сертифицирована по Международному стандарту ISO 9001;
- Лицензия ФСБ на осуществление работ с использованием сведений, составляющих государственную тайну;
- Поставка специализированных компонентов (Xilinx, Altera, Analog Devices, Intersil, Interpoint, Microsemi, Aeroflex, Peregrine, Syfer, Eurofarad, Texas Instrument, Miteq, Cobham, E2V, MA-COM, Hittite, Mini-Circuits, General Dynamics и др.);

Помимо этого, одним из направлений компании «ЭлектроПласт» является направление «Источники питания». Мы предлагаем Вам помощь Конструкторского отдела:

- Подбор оптимального решения, техническое обоснование при выборе компонента;
- Подбор аналогов;
- Консультации по применению компонента;
- Поставка образцов и прототипов;
- Техническая поддержка проекта;
- Защита от снятия компонента с производства.



#### Как с нами связаться

**Телефон:** 8 (812) 309 58 32 (многоканальный)

**Факс:** 8 (812) 320-02-42

**Электронная почта:** [org@eplast1.ru](mailto:org@eplast1.ru)

**Адрес:** 198099, г. Санкт-Петербург, ул. Калинина, дом 2, корпус 4, литера А.