

HF RoHS MC Series - DO-214



Agency Approvals

Agency	Agency File Number
	E133083

Pinout Designation

NOT APPLICABLE

Schematic Symbol



Description

MC Series DO-214 are low capacitance SIDACTor® devices designed to protect broadband equipment such as VOIP, DSL modems and DSLAMs from damaging overvoltage transients.

The series provides a surface mount solution that enables equipment to comply with global regulatory standards while limiting the impact to broadband signals.

Features and Benefits

- Low voltage overshoot
- Low on-state voltage
- Does not degrade with use
- Fails short circuit when surged in excess of ratings
- 40% lower capacitance than our Baseband Protectors, for applications that demand greater signal integrity

Applicable Global Standards

- TIA-968-A
- TIA-968-B
- ITU K.20/21 Enhanced Level*
- ITU K.20/21 Basic Level*
- GR 1089 Intra-building*
- IEC 61000-4-5
- YD/T 1082
- YD/T 993
- YD/T 950

*A-rated parts require series resistance

Electrical Characteristics

Part Number	Marking	V_{DRM} @ $I_{DRM}=5\mu A$	V_S @ 100V/ μs	I_H	I_S	I_T	V_T @ $I_T=2.2$ Amps	Capacitance @ 1MHz, 2V bias	
		V min	V max	mA min	mA max	A max	V max	pF min	pF max
P0080SAMCLRP	P-8AM	6	25	50	800	2.2	4	25	55
P0220SAMCLRP	P02AM	15	32	50	800	2.2	4	25	50
P0300SAMCLRP	P03AM	25	40	50	800	2.2	4	15	35
P0080SCMCLRP	P-8CM	6	25	50	800	2.2	4	25	75
P0220SCMCLRP	P02CM	15	32	50	800	2.2	4	30	65
P0300SCMCLRP	P03CM	25	40	50	800	2.2	4	25	45
P0640SCMCLRP	P06CM	58	77	150	800	2.2	4	55	85
P0720SCMCLRP	P07CM	65	88	150	800	2.2	4	50	75
P0900SCMCLRP	P09CM	75	98	150	800	2.2	4	45	70
P1100SCMCLRP	P11CM	90	130	150	800	2.2	4	45	70
P1300SCMCLRP	P13CM	120	160	150	800	2.2	4	40	60
P1500SCMCLRP	P15CM	140	180	150	800	2.2	4	35	55
P1800SCMCLRP	P18CM	170	220	150	800	2.2	4	35	50
P2100SCMCLRP	P21CM	180	240	150	800	2.2	4	30	50
P2300SCMCLRP	P23CM	190	260	150	800	2.2	4	30	50
P2600SCMCLRP	P26CM	220	300	150	800	2.2	4	30	45
P3100SCMCLRP	P31CM	275	350	150	800	2.2	4	30	45
P3500SCMCLRP	P35CM	320	400	150	800	2.2	4	25	40

Notes:
- Absolute maximum ratings measured at $T_A = 25^\circ C$ (unless otherwise noted).
© 2011 Littelfuse, Inc. All rights reserved.
Specifications are subject to change without notice.
Please refer to www.littelfuse.com for current information.

Surge Ratings

Series	I_{PP}										I_{TSM} 50/60 Hz	di/dt
	0.2x310 ¹	2x10 ¹	8x20 ¹	10x160 ¹	10x560 ¹	5x320 ¹	10x360 ¹	10x1000 ¹	5x310 ¹	10x700 ²		
	0.5x700 ²	2x10 ²	1.2x50 ²	10x160 ²	10x560 ²	9x720 ²	10x360 ²	10x1000 ²	10x700 ²	10x700 ²		
	A min	A min	A min	A min	A min	A min	A min	A min	A min	A min	A min	A/μs max
A	20	150	150	90	50	75	75	45	75	20	500	
C	50	500	400	200	150	200	175	100	200	30	500	

Notes:
 - Peak pulse current rating (I_{pp}) is repetitive and guaranteed for the life of the product.
 - I_{pp} ratings applicable over temperature range of -40°C to +85°C
 - The device must initially be in thermal equilibrium with -40°C ≤ T_j ≤ +150°C

Thermal Considerations

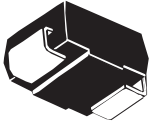
Package	Symbol	Parameter	Value	Unit
DO-214AA 	T_j	Operating Junction Temperature Range	-40 to +150	°C
	T_s	Storage Temperature Range	-65 to +150	°C
	$R_{θJA}$	Thermal Resistance: Junction to Ambient	90	°C/W

V-I Characteristics



$t_r \times t_d$ Pulse Waveform



Normalized V_s Change vs. Junction Temperature

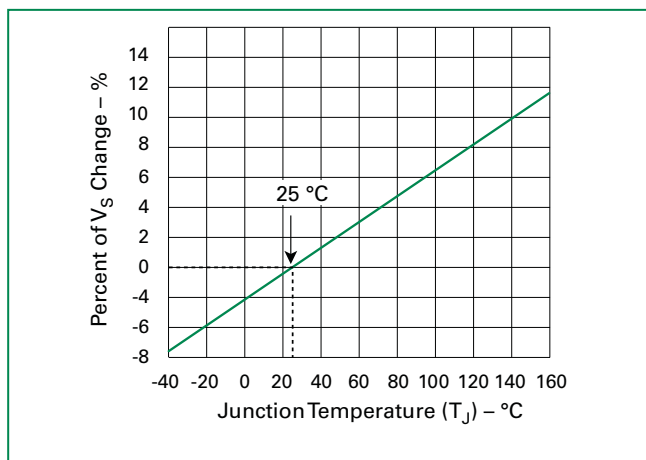

Normalized DC Holding Current vs. Case Temperature



Soldering Parameters

Reflow Condition		Pb-Free assembly (see Fig. 1)
Pre Heat	- Temperature Min ($T_{s(min)}$)	+150°C
	- Temperature Max ($T_{s(max)}$)	+200°C
	- Time (Min to Max) (t_s)	60-180 secs.
Average ramp up rate (Liquidus Temp (T_L) to peak)		3°C/sec. Max.
$T_{s(max)}$ to T_L - Ramp-up Rate		3°C/sec. Max.
Reflow	- Temperature (T_L) (Liquidus)	+217°C
	- Temperature (t_L)	60-150 secs.
Peak Temp (T_p)		+260(+0/-5)°C
Time within 5°C of actual Peak Temp (t_p)		30 secs. Max.
Ramp-down Rate		6°C/sec. Max.
Time 25°C to Peak Temp (T_p)		8 min. Max.
Do not exceed		+260°C



Physical Specifications

Lead Material	Copper Alloy
Terminal Finish	100% Matte-Tin Plated
Body Material	UL recognized epoxy meeting flammability classification 94V-0

Environmental Specifications

High Temp Voltage Blocking	80% Rated V_{DRM} ($V_{AC Peak}$) +125°C or +150°C, 504 or 1008 hrs. MIL-STD-750 (Method 1040) JEDEC, JESD22-A-101
Temp Cycling	-65°C to +150°C, 15 min. dwell, 10 up to 100 cycles. MIL-STD-750 (Method 1051) EIA/JEDEC, JESD22-A-104
Biased Temp & Humidity	52 V_{DC} (+85°C) 85%RH, 504 up to 1008 hrs. EIA/JEDEC, JESD22-A-101
High Temp Storage	+150°C 1008 hrs. MIL-STD-750 (Method 1031) JEDEC, JESD22-A-101
Low Temp Storage	-65°C, 1008 hrs.
Thermal Shock	0°C to +100°C, 5 min. dwell, 10 sec. transfer, 10 cycles. MIL-STD-750 (Method 1056) JEDEC, JESD22-A-106
Autoclave (Pressure Cooker Test)	+121°C, 100%RH, 2atm, 24 up to 168 hrs. EIA/JEDEC, JESD22-A-102
Resistance to Solder Heat	+260°C, 30 secs. MIL-STD-750 (Method 2031)
Moisture Sensitivity Level	85%RH, +85°C, 168 hrs., 3 reflow cycles (+260°C Peak). JEDEC-J-STD-020, Level 1

Dimensions — DO-214AA



Dimensions	Inches		Millimeters	
	Min	Max	Min	Max
A	0.130	0.156	3.30	3.95
B	0.201	0.220	5.10	5.60
C	0.077	0.087	1.95	2.20
D	0.159	0.181	4.05	4.60
E	0.030	0.063	0.75	1.60
F	0.075	0.096	1.90	2.45
G	0.002	0.008	0.05	0.20
H	0.077	0.104	1.95	2.65
K	0.006	0.016	0.15	0.41

Part Numbering



Part Marking



Packing Options

Package Type	Description	Quantity	Added Suffix	Industry Standard
S	DO-214AA Tape & Reel Pack	2500	N/A	EIA-481-D

Tape and Reel Specification — DO-214AA





Компания «ЭлектроПласт» предлагает заключение долгосрочных отношений при поставках импортных электронных компонентов на взаимовыгодных условиях!

Наши преимущества:

- Оперативные поставки широкого спектра электронных компонентов отечественного и импортного производства напрямую от производителей и с крупнейших мировых складов;
- Поставка более 17-ти миллионов наименований электронных компонентов;
- Поставка сложных, дефицитных, либо снятых с производства позиций;
- Оперативные сроки поставки под заказ (от 5 рабочих дней);
- Экспресс доставка в любую точку России;
- Техническая поддержка проекта, помощь в подборе аналогов, поставка прототипов;
- Система менеджмента качества сертифицирована по Международному стандарту ISO 9001;
- Лицензия ФСБ на осуществление работ с использованием сведений, составляющих государственную тайну;
- Поставка специализированных компонентов (Xilinx, Altera, Analog Devices, Intersil, Interpoint, Microsemi, Aeroflex, Peregrine, Syfer, Eurofarad, Texas Instrument, Miteq, Cobham, E2V, MA-COM, Hittite, Mini-Circuits, General Dynamics и др.);

Помимо этого, одним из направлений компании «ЭлектроПласт» является направление «Источники питания». Мы предлагаем Вам помощь Конструкторского отдела:

- Подбор оптимального решения, техническое обоснование при выборе компонента;
- Подбор аналогов;
- Консультации по применению компонента;
- Поставка образцов и прототипов;
- Техническая поддержка проекта;
- Защита от снятия компонента с производства.



Как с нами связаться

Телефон: 8 (812) 309 58 32 (многоканальный)

Факс: 8 (812) 320-02-42

Электронная почта: org@eplast1.ru

Адрес: 198099, г. Санкт-Петербург, ул. Калинина, дом 2, корпус 4, литера А.