

## FEATURES

- Input voltage range:** -2.0 V to -5.5 V
- Maximum output current:** -500 mA
- Fixed output voltage options:** -0.5 V to -4.5 V
- Adjustable output from:** -0.5 V to  $-V_{IN} + 0.5$  V
- Low output noise:** 4  $\mu$ V rms from 100 Hz to 100 kHz
- Noise spectral density:** 20 nV/ $\sqrt{\text{Hz}}$ , 10 kHz to 1 MHz
- PSRR at -500 mA load**
  - 68 dB at 10 kHz
  - 50 dB at 100 kHz
  - 40 dB at 1 MHz
- Low dropout voltage:** -190 mV typical at -500 mA load
- Initial output voltage ( $V_{OUT}$ ) accuracy:**  $\pm 0.5\%$
- Output voltage accuracy over line, load, and temperature:**  $\pm 2.2\%$
- Operating supply current ( $I_{GND}$ ):** -0.6 mA typical at no load
- Low shutdown current:** -2  $\mu$ A typical at  $V_{IN} = -5.5$  V
- Stable with small 4.7  $\mu$ F ceramic input and output capacitor**
- Positive or negative enable logic**
- Current-limit and thermal overload protection**
- 8-lead, 2 mm  $\times$  2 mm LFCSP package**
- Supported by [ADIsimPOWER](#) voltage regulator design tool**

## APPLICATIONS

- Regulation to noise sensitive applications: analog-to-digital converters (ADCs), digital-to-analog converters (DACs), precision amplifiers**
- Communications and infrastructure**
- Medical and healthcare**
- Industrial and instrumentation**

## GENERAL DESCRIPTION

The ADP7185 is a complementary metal oxide semiconductor (CMOS), low dropout (LDO) linear regulator that operates from -2.0 V to -5.5 V and provides up to -500 mA of output current. This high output current LDO is ideal for regulation of high performance analog and mixed signal circuits operating from -0.5 V down to -4.5 V. Using an advanced proprietary architecture, the ADP7185 provides high power supply rejection ratio (PSRR) and low noise, and it achieves excellent line and load transient response with a small 4.7  $\mu$ F ceramic output capacitor.

The ADP7185 is available in 15 fixed output voltage options. The following voltages are available from stock: -0.5 V, -1.0 V, -1.2 V, -1.5 V, -1.8 V, -2.0 V, -2.5 V, -3.0 V, and -3.3 V.

## TYPICAL APPLICATION CIRCUITS

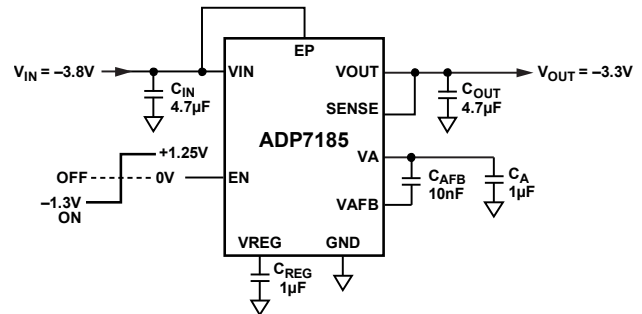

Figure 1. ADP7185 with Fixed Output Voltage,  $V_{OUT} = -3.3$  V

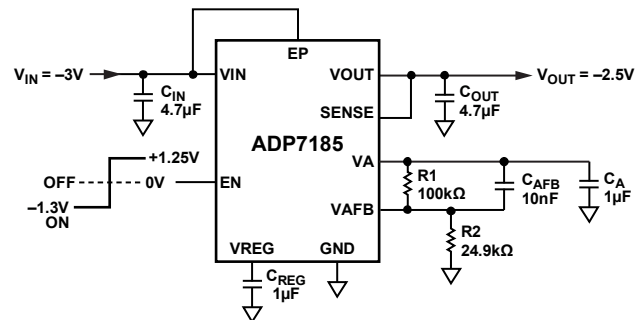

Figure 2. ADP7185 with Adjustable Output Voltage,  $V_{OUT} = -2.5$  V

Additional voltages available by special order are -0.8 V, -0.9 V, -1.3 V, -2.8 V, -4.2 V, and -4.5 V. An adjustable version is also available which allows output voltages that range from -0.5 V to  $-V_{IN} + 0.5$  V with an external feedback divider.

The enable logic feature is capable of interfacing with positive or negative logic levels for maximum flexibility.

The ADP7185 regulator output noise is 4  $\mu$ V rms independent of the output voltage. The ADP7185 is available in an 8-lead, 2 mm  $\times$  2 mm LFCSP, making it not only a very compact solution but also providing excellent thermal performance for applications requiring up to -500 mA of output current in a small, low profile footprint.

## TABLE OF CONTENTS

Features .....	1	Theory of Operation .....	13
Applications.....	1	Adjustable Mode Operation .....	13
Typical Application Circuits.....	1	Enable Pin Operation .....	13
General Description .....	1	Start-Up Time .....	14
Revision History .....	2	Applications Information .....	15
Specifications.....	3	ADIsimPower Design Tool .....	15
Input and Output Capacitor Recommended Specifications... 4		Capacitor Selection .....	15
Absolute Maximum Ratings.....	5	Undervoltage Lockout (UVLO) .....	16
Thermal Data .....	5	Current-Limit and Thermal Overload Protection.....	16
Thermal Resistance .....	5	Thermal Considerations.....	17
ESD Caution.....	5	Outline Dimensions .....	19
Pin Configuration and Function Descriptions.....	6	Ordering Guide .....	19
Typical Performance Characteristics .....	7		

## REVISION HISTORY

5/2017—Revision 0: Initial Version

## SPECIFICATIONS

$V_{IN} = (V_{OUT} - 0.5 \text{ V})$  or  $-2 \text{ V}$  (whichever is more negative),  $EN = V_{IN}$ ,  $I_{OUT} = -10 \text{ mA}$ ,  $C_{IN} = C_{OUT} = 4.7 \mu\text{F}$ ,  $C_{AFB} = 10 \text{ nF}$ ,  $C_A = C_{REG} = 1 \mu\text{F}$ ,  $T_A = 25^\circ\text{C}$  for typical specifications, and  $T_J = -40^\circ\text{C}$  to  $+125^\circ\text{C}$  for minimum/maximum specifications, unless otherwise noted.

Table 1.

Parameter	Symbol	Test Conditions/Comments	Min	Typ	Max	Unit
INPUT VOLTAGE RANGE	$V_{IN}$		-2.0		-5.5	V
LOAD CURRENT	$I_{LOAD}$				-500	mA
OPERATING SUPPLY CURRENT	$I_{GND}$	$I_{OUT} = 0 \mu\text{A}$		-0.6	-0.90	mA
		$I_{OUT} = -500 \text{ mA}$		-5.5	-7.0	mA
SHUTDOWN CURRENT	$I_{GND-SD}$	$EN = GND, V_{IN} = -5.5 \text{ V}$		-2	-7	$\mu\text{A}$
OUTPUT NOISE <sup>1</sup>	$OUT_{NOISE}$	10 Hz to 100 kHz, $C_{AFB} = 1 \text{ nF}$		7		$\mu\text{V rms}$
		10 Hz to 100 kHz, $C_{AFB} = 10 \text{ nF}$		5		$\mu\text{V rms}$
		100 Hz to 100 kHz, $C_{AFB} = 1 \text{ nF}$		6		$\mu\text{V rms}$
		100 Hz to 100 kHz, $C_{AFB} = 10 \text{ nF}$		4		$\mu\text{V rms}$
NOISE SPECTRAL DENSITY <sup>1</sup>	$OUT_{NSD}$	100 Hz, $C_{AFB} = 1 \text{ nF}$		300		$\text{nV}/\sqrt{\text{Hz}}$
		100 Hz, $C_{AFB} = 10 \text{ nF}$		100		$\text{nV}/\sqrt{\text{Hz}}$
		10 kHz to 1 MHz, $C_{AFB} = 1 \text{ nF}$ to $1 \mu\text{F}$		20		$\text{nV}/\sqrt{\text{Hz}}$
POWER SUPPLY REJECTION RATIO <sup>1</sup>	PSRR	$I_{OUT} = -500 \text{ mA}, V_{OUT} = -3.3 \text{ V}, V_{IN} = -3.8 \text{ V}$				
		At 1 kHz		80		dB
		At 10 kHz		68		dB
		At 100 kHz		50		dB
		At 1 MHz		40		dB
OUTPUT VOLTAGE Accuracy	$V_{OUT}$	$I_{OUT} = -10 \text{ mA}, T_A = 25^\circ\text{C}$	-0.5		-4.5	V
		$-1 \text{ mA} < I_{OUT} < -500 \text{ mA}, V_{IN} = (V_{OUT} - 0.5 \text{ V})$	-0.5		+0.5	%
		to $-5.5 \text{ V}$	-2.2		+2.2	%
OUTPUT VOLTAGE REFERENCE FEEDBACK $V_{AFB}$ Accuracy	$V_{AFB}$	Adjustable model voltage reference	-0.489	-0.5	-0.511	V
		Adjustable model, $-1 \text{ mA} < I_{OUT} < -500 \text{ mA}, V_{IN} = (V_{OUT} - 0.5 \text{ V})$ to $-5.5 \text{ V}$	-2.2		+2.2	%
LINE REGULATION	$\Delta V_{OUT}/\Delta V_{IN}$	$V_{IN} = (V_{OUT} - 0.5 \text{ V})$ to $-5.5 \text{ V}$	-0.1		+0.3	%/V
LOAD REGULATION <sup>2</sup>	$\Delta V_{OUT}/\Delta I_{OUT}$	$I_{OUT} = -1 \text{ mA}$ to $-500 \text{ mA}$		0.6	1.8	%/A
INPUT BIAS CURRENT SENSE	$SENSE_{I-BIAS}$	$-1 \text{ mA} < I_{OUT} < -500 \text{ mA}, V_{IN} = (V_{OUT} - 0.5 \text{ V})$ to $-5.5 \text{ V}$		-10		nA
	$V_{AFB}$	$V_{AFB-BIAS}$		-10		nA
DROPOUT VOLTAGE <sup>3</sup>	$V_{DROPOUT}$	$I_{OUT} = -100 \text{ mA}$		-30	-60	mV
		$I_{OUT} = -500 \text{ mA}$		-190	-360	mV
PULL-DOWN RESISTANCE	$V_{OUT-PULL}$	$V_{EN} = 0 \text{ V}$ $V_{OUT} = -1 \text{ V}$		280		$\Omega$
	$V_{REG-PULL}$	$V_{REG} = -1 \text{ V}$		1.3		k $\Omega$
	$V_A-PULL$	$V_A = -1 \text{ V}$		61		$\Omega$
START-UP TIME <sup>4</sup>	$T_{START-UP}$	$V_{OUT} = -4.5 \text{ V}, C_{AFB} = 1 \text{ nF}, C_A = 1 \mu\text{F}$		15		ms
		$V_{OUT} = -4.5 \text{ V}, C_{AFB} = 10 \text{ nF}, C_A = 1 \mu\text{F}$		55		ms
		$V_{OUT} = -1.2 \text{ V}, C_{AFB} = 1 \text{ nF}, C_A = 1 \mu\text{F}$		4		ms
		$V_{OUT} = -1.2 \text{ V}, C_{AFB} = 10 \text{ nF}, C_A = 1 \mu\text{F}$		10		ms
		$V_{OUT} = -0.5 \text{ V}, \text{no } C_{AFB}, C_A = 1 \mu\text{F}$		1.5		ms
CURRENT-LIMIT THRESHOLD <sup>5</sup>	$I_{LIMIT}$		-600	-900	-1100	mA
THERMAL SHUTDOWN	Threshold	$T_J$ rising		150		$^\circ\text{C}$
	Hysteresis			15		$^\circ\text{C}$

Parameter	Symbol	Test Conditions/Comments	Min	Typ	Max	Unit
<b>UNDERVOLTAGE LOCKOUT THRESHOLDS</b>						
Input Voltage						
Rising	UVLO <sub>RISE</sub>				-1.77	V
Falling	UVLO <sub>FALL</sub>		-1.58			V
Hysteresis	UVLO <sub>HYS</sub>			90		mV
<b>EN INPUT (NEGATIVE)</b>						
Logic High	V <sub>EN-NEG-HIGH</sub>	-2 V ≤ V <sub>IN</sub> ≤ -5.5 V V <sub>OUT</sub> = off to on	-1.3	-1.16		V
Logic Low	V <sub>EN-NEG-LOW</sub>	V <sub>OUT</sub> = on to off		-0.96	-0.88	V
Hysteresis	EN <sub>HYS-NEG</sub>			191		mV
Leakage Current	I <sub>EN-LKG</sub>	EN = V <sub>IN</sub> or GND		-0.25		μA
<b>EN INPUT (POSITIVE)</b>						
Logic High	V <sub>EN-POS-HIGH</sub>	-2 V ≤ V <sub>IN</sub> ≤ -5.5 V V <sub>OUT</sub> = off to on		0.96	1.25	V
Logic Low	V <sub>EN-POS-LOW</sub>	V <sub>OUT</sub> = on to off	0.5	0.89		V
Leakage Current	I <sub>EN-LKG</sub>	V <sub>EN</sub> = 5 V, V <sub>IN</sub> = -5.5 V		4.0	6.0	μA

<sup>1</sup> Guaranteed by characterization but not production tested.

<sup>2</sup> Based on an endpoint calculation using -1 mA and -500 mA loads.

<sup>3</sup> Dropout voltage is defined as the input to output voltage differential when the input voltage is set to the nominal output voltage. Dropout applies only for output voltages below -2 V.

<sup>4</sup> Start-up time is defined as the time between the rising edge of EN to V<sub>OUT</sub> being at 90% of its nominal value.

<sup>5</sup> Current-limit threshold is defined as the current at which the output voltage drops to 90% of the specified typical value. For example, the current limit threshold for a -3.0 V output voltage is defined as the current that causes the output voltage to drop to 90% of -3.0 V, or -2.7 V.

## INPUT AND OUTPUT CAPACITOR RECOMMENDED SPECIFICATIONS

Table 2.

Parameter	Symbol	Test Conditions/Comments	Min	Typ	Max	Unit
<b>CAPACITANCE</b>						
Minimum C <sub>IN</sub> and C <sub>OUT</sub> Capacitance <sup>1</sup>	C <sub>IN</sub> , C <sub>OUT</sub>	T <sub>A</sub> = -40°C to +125°C	3.3	4.7		μF
Minimum C <sub>A</sub> and C <sub>REG</sub> Capacitance <sup>2</sup>	C <sub>A</sub> , C <sub>REG</sub>		0.7	1		μF
Minimum C <sub>AFB</sub> Capacitance <sup>3</sup>	C <sub>AFB</sub>		0.7	10		nF
Capacitor Equivalent Series Resistance (ESR)	R <sub>ESR</sub>				0.1	Ω

<sup>1</sup> The minimum input and output capacitance must be greater than 3.3 μF over the full range of operating conditions. X7R and X5R type capacitors are recommended; Y5V and Z5U capacitors are not recommended for use with any LDO.

<sup>2</sup> The minimum C<sub>A</sub> and C<sub>REG</sub> capacitance must be greater than 0.7 μF over the full range of operating conditions. X7R and X5R type capacitors are recommended; Y5V and Z5U capacitors are not recommended for use with any LDO.

<sup>3</sup> The minimum C<sub>AFB</sub> capacitance must be greater than 0.7 nF over the full range of operating conditions. X7R and X5R type capacitors are recommended; Y5V and Z5U capacitors are not recommended for use with any LDO.

## ABSOLUTE MAXIMUM RATINGS

Table 3.

Parameter	Rating
VIN to GND	+0.3 V to -6 V
VOU to GND	+0.3 V to -VIN
EN to GND	+5.0 V to -6 V
VA to GND	+0.3 V to -6 V
VAFB to GND	+0.3 V to -6 V
VREG to GND	+0.3 V to -2.16 V
SENSE to GND	+0.3 V to -6 V
Storage Temperature Range	-65°C to +150°C
Operating Junction Temperature Range	-40°C to +125°C
Soldering Conditions	JEDEC J-STD-020

Stresses at or above those listed under Absolute Maximum Ratings may cause permanent damage to the product. This is a stress rating only; functional operation of the product at these or any other conditions above those indicated in the operational section of this specification is not implied. Operation beyond the maximum operating conditions for extended periods may affect product reliability.

### THERMAL DATA

Absolute maximum ratings apply individually only, not in combination. The ADP7185 can be damaged when the junction temperature limits are exceeded. Monitoring ambient temperature does not guarantee that  $T_J$  is within the specified temperature limits. In applications with high power dissipation and poor thermal resistance, the maximum ambient temperature may have to be derated.

In applications with moderate power dissipation and low printed circuit board (PCB) thermal resistance, the maximum ambient temperature can exceed the maximum limit as long as the junction temperature is within specification limits. The junction

temperature ( $T_J$ ) of the device is dependent on the ambient temperature ( $T_A$ ), the power dissipation of the device ( $P_D$ ), and the junction to ambient thermal resistance of the package ( $\theta_{JA}$ ).

Use the following equation to calculate the junction temperature ( $T_J$ ) from the ambient temperature ( $T_A$ ) and power dissipation ( $P_D$ ):

$$T_J = T_A + (P_D \times \theta_{JA})$$

The junction to ambient thermal resistance ( $\theta_{JA}$ ) of the package is based on modeling and calculation using a 4-layer board. The junction to ambient thermal resistance is highly dependent on the application and board layout. In applications where high maximum power dissipation exists, close attention to thermal board design is required. The  $\theta_{JA}$  value may vary, depending on the PCB material, layout, and environmental conditions. The specified  $\theta_{JA}$  values are based on a 4-layer, 4 in. × 3 in. circuit board.

### THERMAL RESISTANCE

Thermal performance is directly linked to printed circuit board (PCB) design and operating environment. Careful attention to PCB thermal design is required.

Table 4. Thermal Resistance

Package Type	$\theta_{JA}$	$\theta_{JC}$	Unit
CP-8-27	68.8	10.0	°C/W

### ESD CAUTION



**ESD (electrostatic discharge) sensitive device.** Charged devices and circuit boards can discharge without detection. Although this product features patented or proprietary protection circuitry, damage may occur on devices subjected to high energy ESD. Therefore, proper ESD precautions should be taken to avoid performance degradation or loss of functionality.

## PIN CONFIGURATION AND FUNCTION DESCRIPTIONS

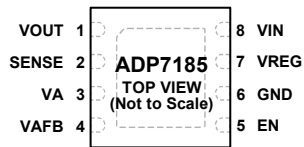

### NOTES

1. EXPOSED PAD. THE EXPOSED PAD ENHANCES THE THERMAL PERFORMANCE AND IS ELECTRICALLY CONNECTED TO VIN INSIDE THE PACKAGE. IT IS RECOMMENDED THAT THE EXPOSED PAD CONNECT TO THE INPUT VOLTAGE PLANE ON THE BOARD.

13832-003

Figure 3. Pin Configuration

Table 5. Pin Function Descriptions

Pin No.	Mnemonic	Description
1	VOUT	Regulated Output Voltage. Bypass VOUT to GND with a 4.7 $\mu$ F or greater capacitor.
2	SENSE	Sense Input. Connect this pin to VOUT.
3	VA	Low Noise Reference Voltage. Connect a 1 $\mu$ F capacitor to GND to reduce noise. Do not connect a load to ground.
4	VAFB	Output Voltage Reference Feedback (Adjust Mode). Connect a 1 nF to 1 $\mu$ F capacitor between the VAFB pin and the VA pin to reduce noise. Start-up time is increased as a function of the capacitance. Connect an external resistor divider between the VA pin and the VAFB pin to set the output voltage in adjust mode.
5	EN	Enable. Drive EN at least +1.25 V above or –1.3 V below ground to enable the regulator or drive EN to ground to turn the regulator off. For automatic startup, connect EN to VIN.
6	GND	Ground.
7	VREG	Regulated Input Supply to the LDO Amplifier. Bypass VREG to GND with a 1 $\mu$ F or greater capacitor. Do not connect a load to ground.
8	VIN	Regulator Input Supply. Bypass VIN to GND with a 4.7 $\mu$ F or greater capacitor.
	EP	Exposed pad. The exposed pad enhances the thermal performance and is electrically connected to VIN inside the package. It is recommended that the exposed pad connect to the input voltage plane on the board.

# TYPICAL PERFORMANCE CHARACTERISTICS

$V_{IN} = -3.8\text{ V}$ ,  $V_{OUT} = -3.3\text{ V}$ ,  $I_{OUT} = -10\text{ mA}$ ,  $C_{IN} = C_{OUT} = 4.7\text{ }\mu\text{F}$ ,  $C_{AFB} = 10\text{ nF}$ ,  $C_A = C_{REG} = 1\text{ }\mu\text{F}$ , and  $T_A = 25^\circ\text{C}$ , unless otherwise noted.

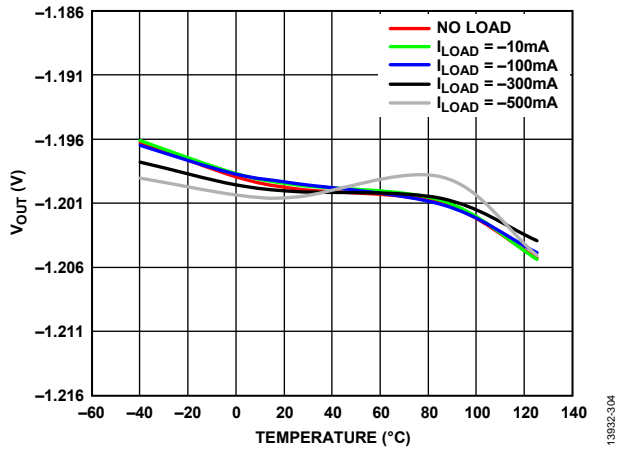

Figure 4. Output Voltage ( $V_{OUT}$ ) vs. Junction Temperature,  $V_{OUT} = -1.2\text{ V}$

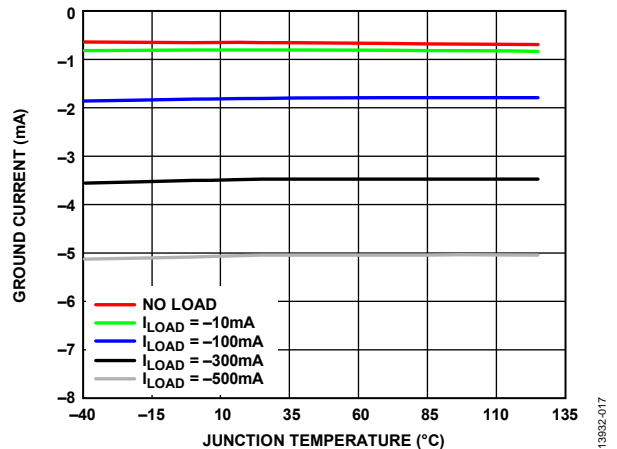

Figure 7. Ground Current vs. Junction Temperature ( $T_j$ ),  $V_{OUT} = -1.2\text{ V}$

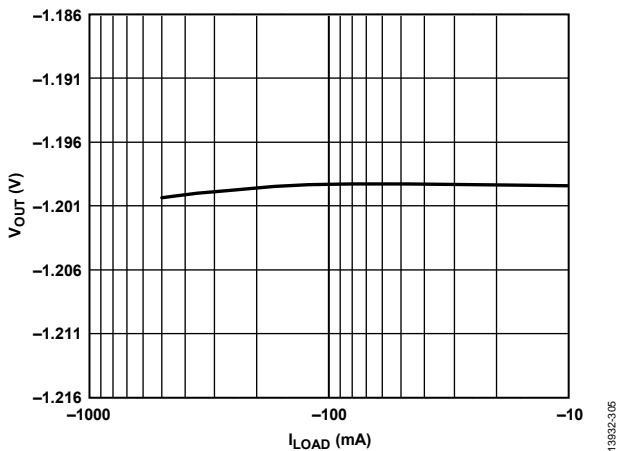

Figure 5. Output Voltage ( $V_{OUT}$ ) vs. Load Current ( $I_{LOAD}$ ),  $V_{OUT} = -1.2\text{ V}$

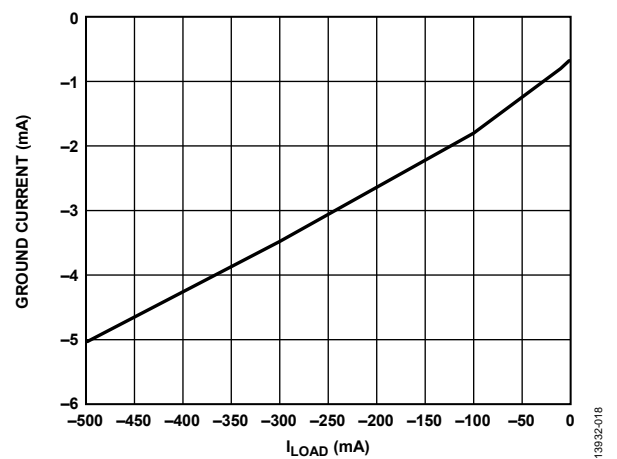

Figure 8. Ground Current vs. Load Current ( $I_{LOAD}$ ),  $V_{OUT} = -1.2\text{ V}$

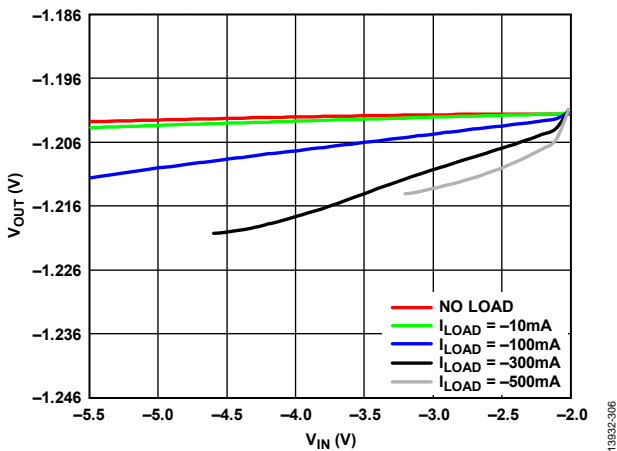

Figure 6. Output Voltage ( $V_{OUT}$ ) vs. Input Voltage ( $V_{IN}$ ),  $V_{OUT} = -1.2\text{ V}$

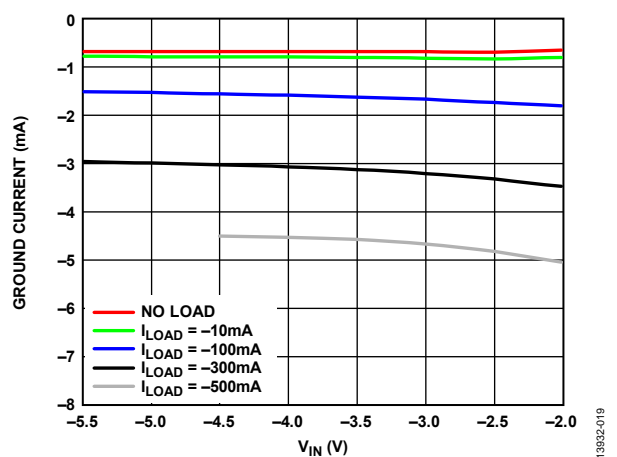

Figure 9. Ground Current vs. Input Voltage ( $V_{IN}$ ),  $V_{OUT} = -1.2\text{ V}$

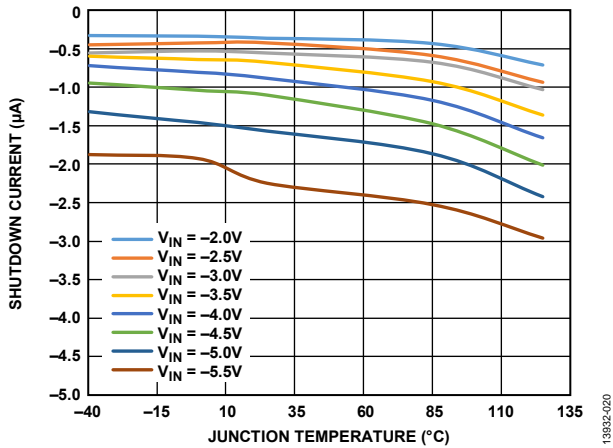

Figure 10. Shutdown Current vs. Junction Temperature at Various Input Voltages,  $V_{OUT} = -1.2V$

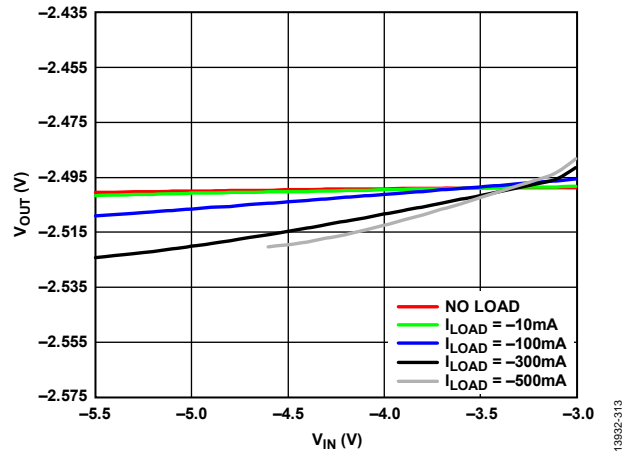

Figure 13. Output Voltage ( $V_{OUT}$ ) vs. Input Voltage ( $V_{IN}$ ),  $V_{OUT} = -2.5V$

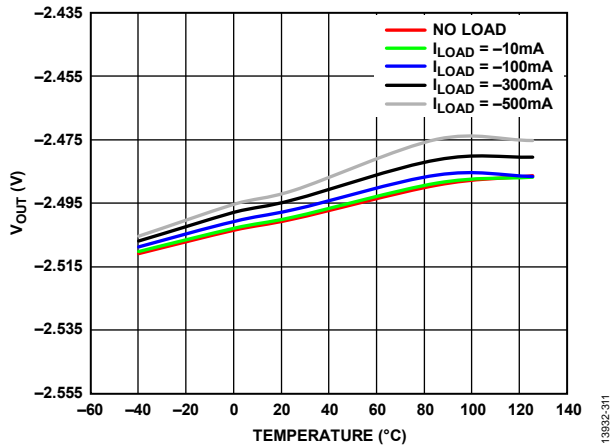

Figure 11. Output Voltage ( $V_{OUT}$ ) vs. Junction Temperature ( $T_j$ ),  $V_{OUT} = -2.5V$

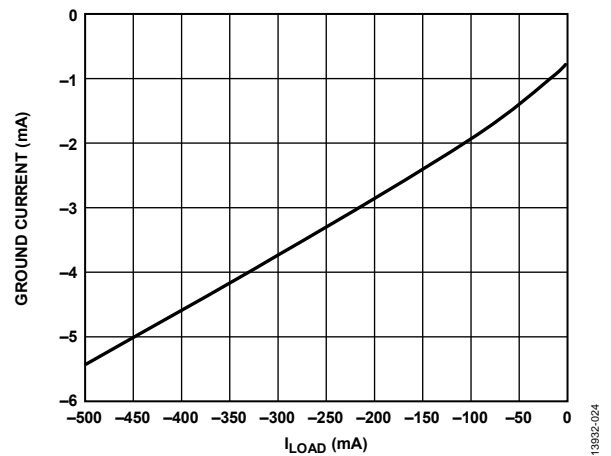

Figure 14. Ground Current vs. Load Current ( $I_{LOAD}$ ),  $V_{OUT} = -2.5V$

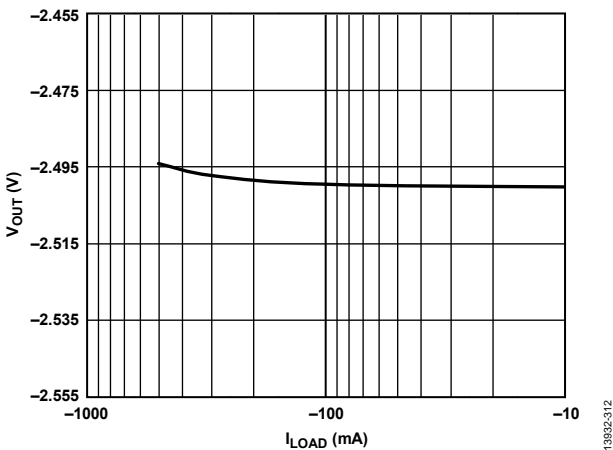

Figure 12. Output Voltage ( $V_{OUT}$ ) vs. Load Current ( $I_{LOAD}$ ),  $V_{OUT} = -2.5V$

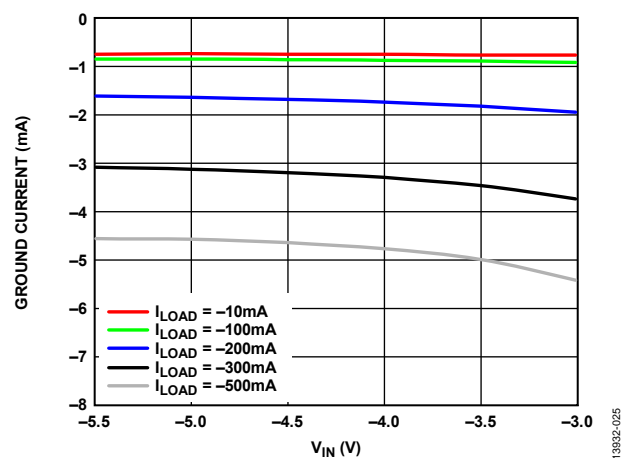

Figure 15. Ground Current vs. Input Voltage ( $V_{IN}$ ),  $V_{OUT} = -2.5V$



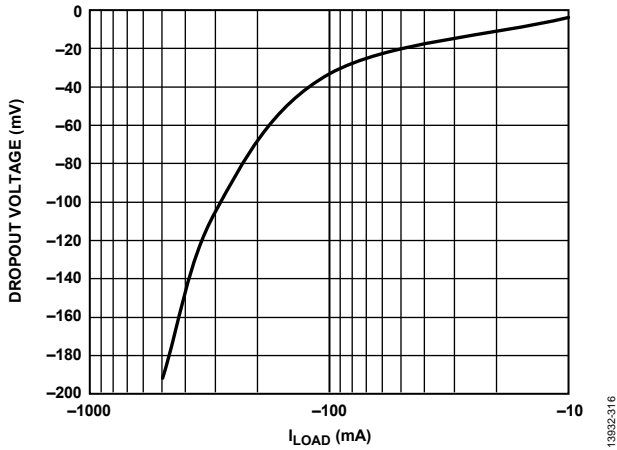

Figure 16. Dropout Voltage vs Load Current ( $I_{LOAD}$ ),  $V_{OUT} = -2.5 V$

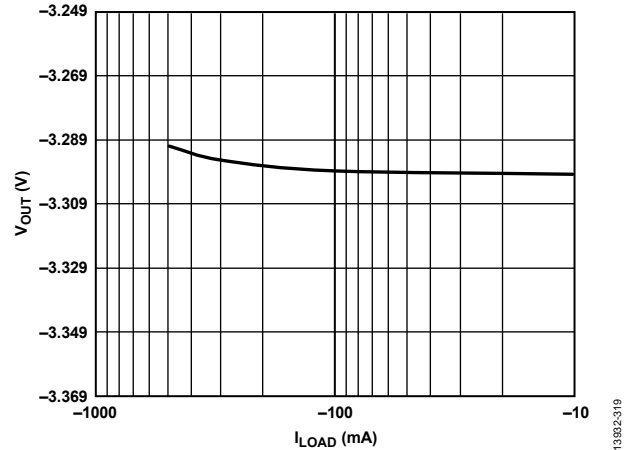

Figure 19. Output Voltage ( $V_{OUT}$ ) vs. Load Current ( $I_{LOAD}$ ),  $V_{OUT} = -3.3 V$

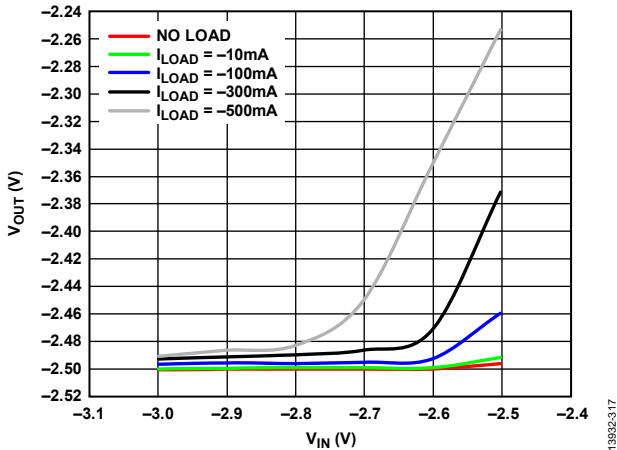

Figure 17. Output Voltage ( $V_{OUT}$ ) vs. Input Voltage ( $V_{IN}$ ) in Dropout at Various Loads,  $V_{OUT} = -2.5 V$

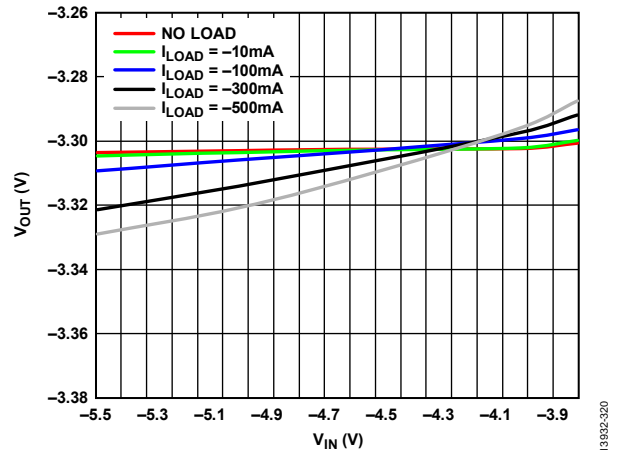

Figure 20. Output Voltage ( $V_{OUT}$ ) vs. Input Voltage ( $V_{IN}$ ),  $V_{OUT} = -3.3 V$

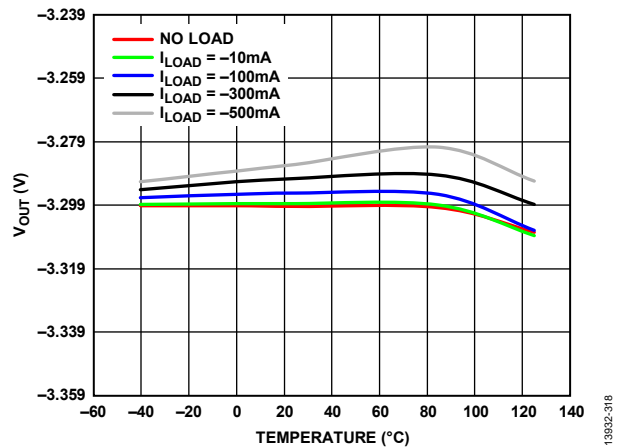

Figure 18. Output Voltage ( $V_{OUT}$ ) vs. Junction Temperature ( $T_J$ ),  $V_{OUT} = -3.3 V$

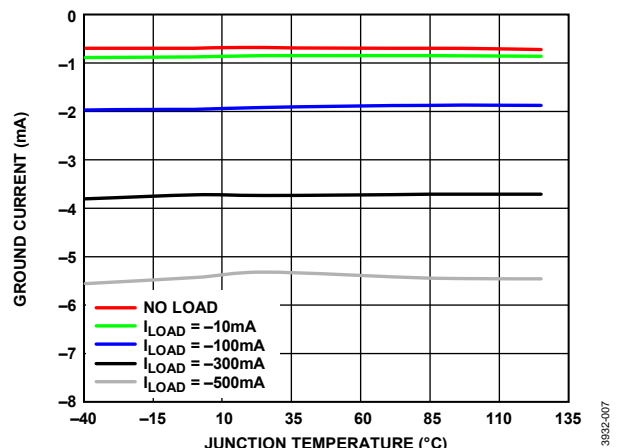

Figure 21. Ground Current vs. Junction Temperature ( $T_J$ ),  $V_{OUT} = -3.3 V$

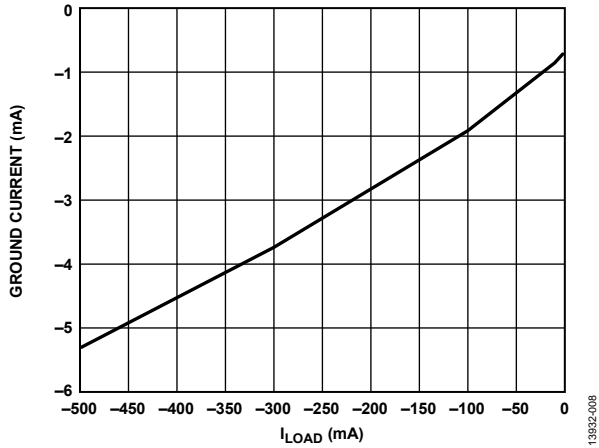

Figure 22. Ground Current vs. Load Current ( $I_{LOAD}$ ),  $V_{OUT} = -3.3 V$

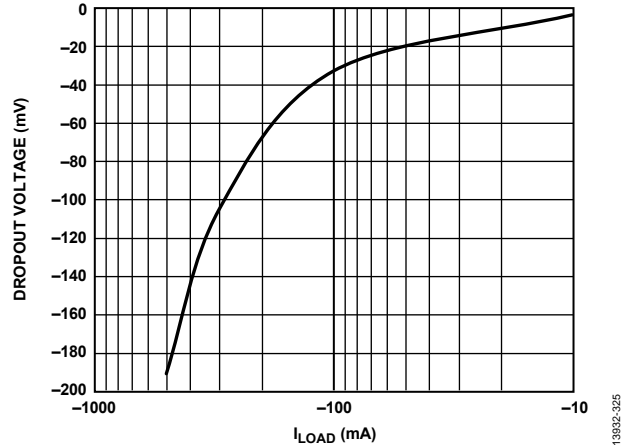

Figure 25. Dropout Voltage vs. Load Current ( $I_{LOAD}$ ),  $V_{OUT} = -3.3 V$

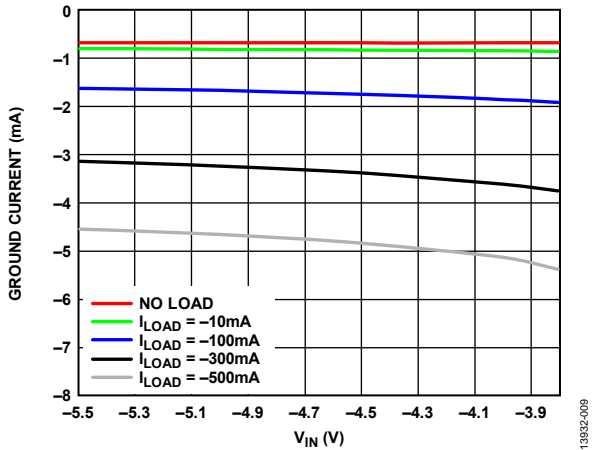

Figure 23. Ground Current vs. Input Voltage ( $V_{IN}$ ),  $V_{OUT} = -3.3 V$

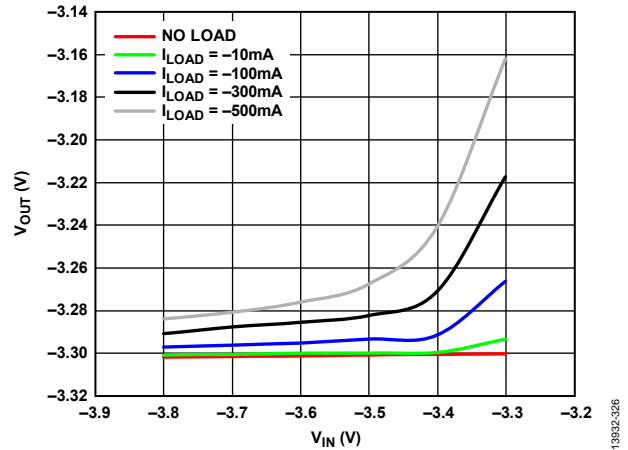

Figure 26. Output Voltage ( $V_{OUT}$ ) vs. Input Voltage ( $V_{IN}$ ) in Dropout at Various Loads,  $V_{OUT} = -3.3 V$

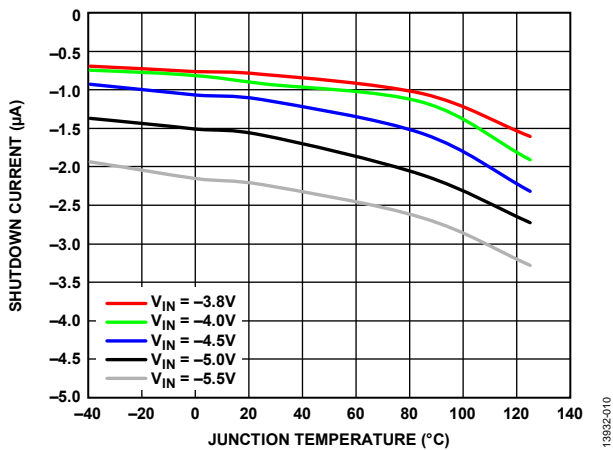

Figure 24. Shutdown Current vs. Junction Temperature at Various Input Voltages,  $V_{OUT} = -3.3 V$

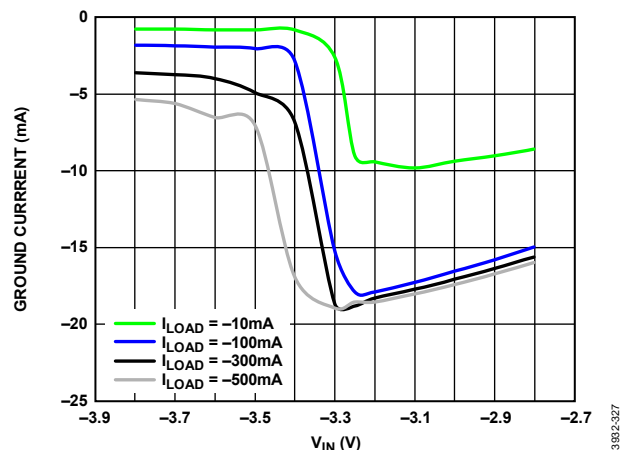

Figure 27. Ground Current vs. Input Voltage ( $V_{IN}$ ) in Dropout at Various Loads,  $V_{OUT} = -3.3 V$

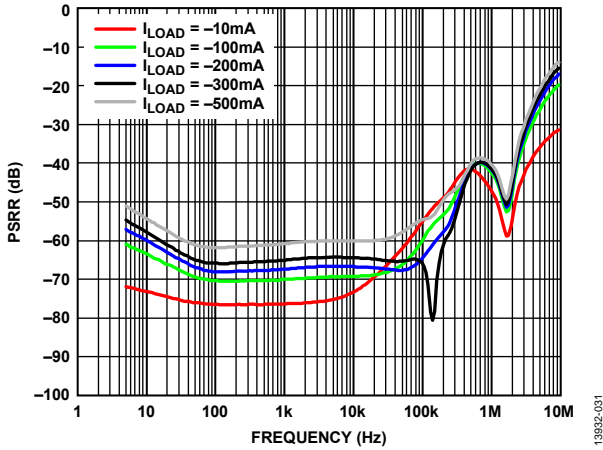

Figure 28. Power Supply Rejection Ratio (PSRR) vs. Frequency at Various Loads,  $V_{OUT} = -1.2V$ ,  $V_{IN} = -2V$

13932-031

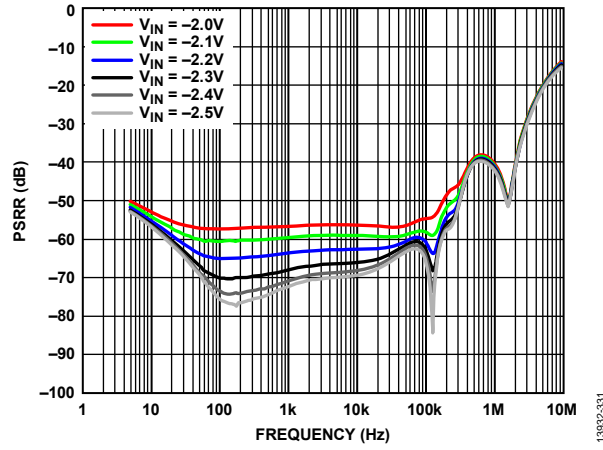

Figure 31. Power Supply Rejection Ratio (PSRR) vs. Frequency at Various Input Voltages,  $V_{OUT} = -1.2V$ ,  $I_{LOAD} = -500mA$

13932-331

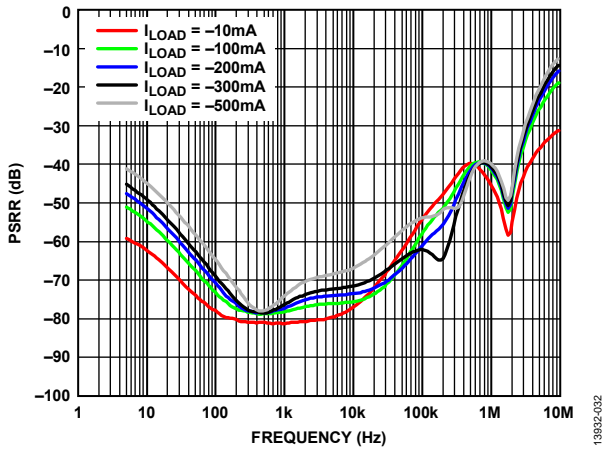

Figure 29. Power Supply Rejection Ratio (PSRR) vs. Frequency at Various Loads,  $V_{OUT} = -2.5V$ ,  $V_{IN} = -3V$

13932-032

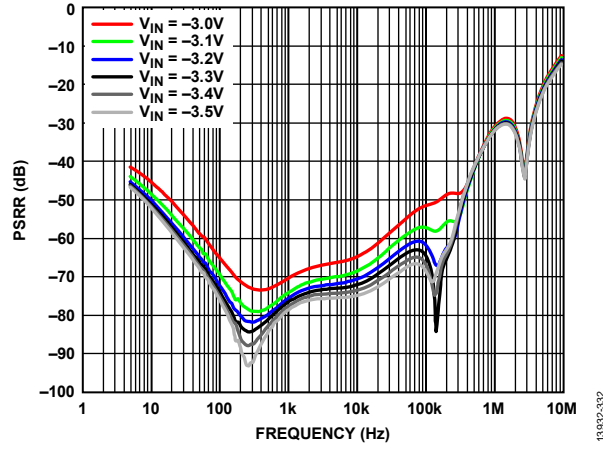

Figure 32. Power Supply Rejection Ratio (PSRR) vs. Frequency at Various Input Voltages,  $V_{OUT} = -2.5V$ ,  $I_{LOAD} = -500mA$

13932-332

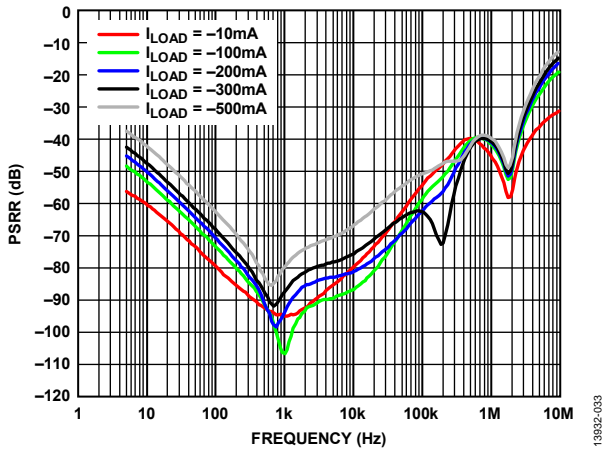

Figure 30. Power Supply Rejection Ratio (PSRR) vs. Frequency at Various Loads,  $V_{OUT} = -3.3V$ ,  $V_{IN} = -3.8V$

13932-033

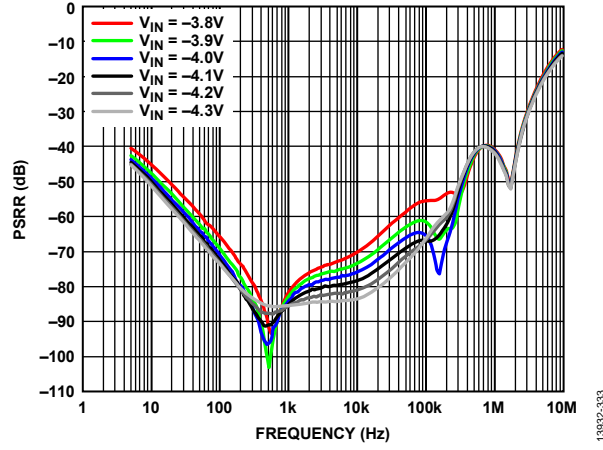

Figure 33. Power Supply Rejection Ratio (PSRR) vs. Frequency at Various Input Voltages,  $V_{OUT} = -3.3V$ ,  $I_{LOAD} = -500mA$

13932-333

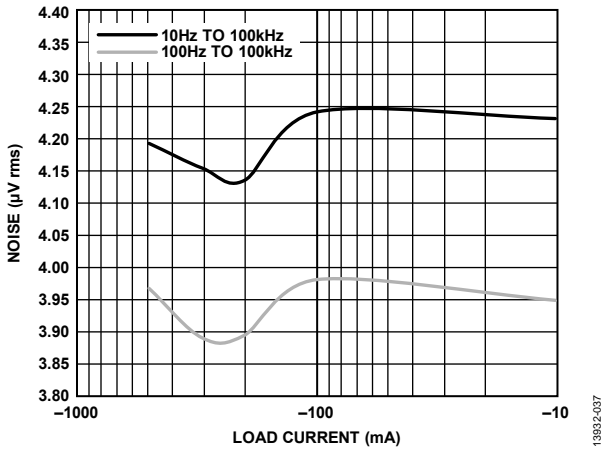

Figure 34. RMS Noise vs. Load Current ( $I_{LOAD}$ ) at Various Frequencies,  $V_{IN} = -3.8\text{ V}$ ,  $V_{OUT} = -3.3\text{ V}$

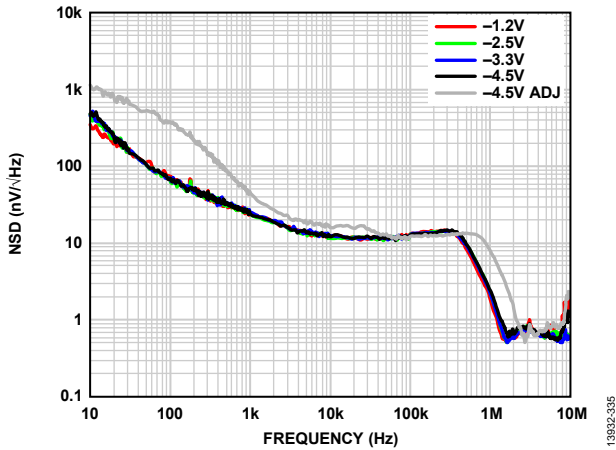

Figure 35. Noise Spectral Density (NSD) vs. Frequency at Various Output Voltages,  $V_{IN} = -3.8\text{ V}$ ,  $V_{OUT} = -3.3\text{ V}$

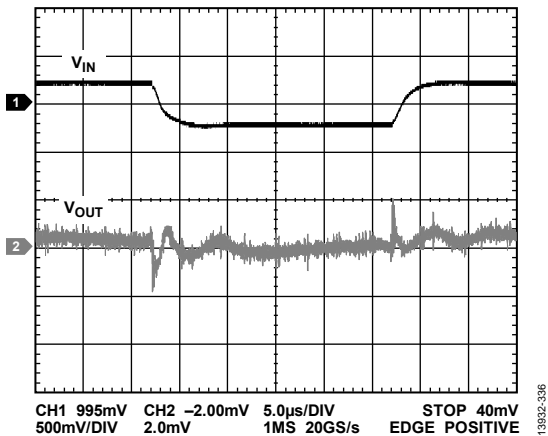

Figure 36. Line Transient Response, 500 mV Step,  $V_{OUT} = -1.2\text{ V}$ ,  $I_{LOAD} = -500\text{ mA}$

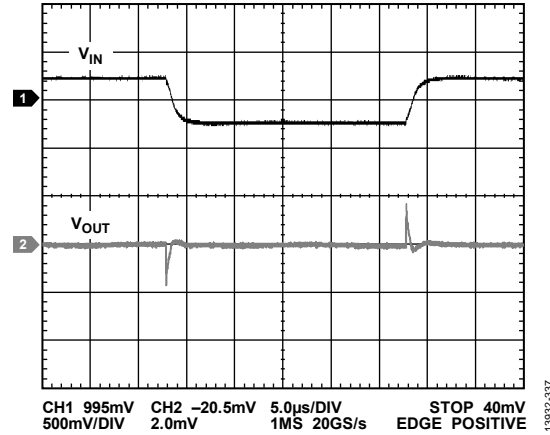

Figure 37. Line Transient Response, 500 mV Step,  $V_{OUT} = -3.3\text{ V}$ ,  $I_{LOAD} = -500\text{ mA}$

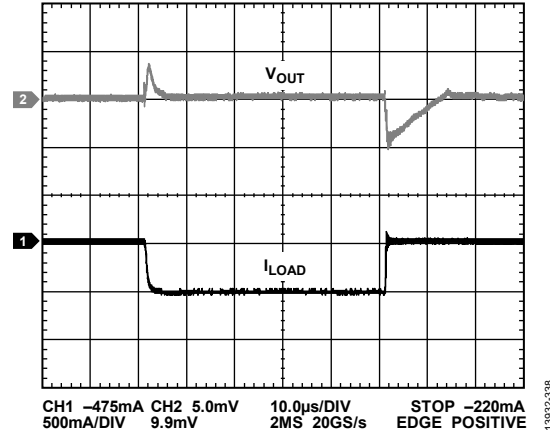

Figure 38. Load Transient Response,  $V_{OUT} = -1.2\text{ V}$ ,  $I_{LOAD} = -10\text{ mA to } -500\text{ mA}$

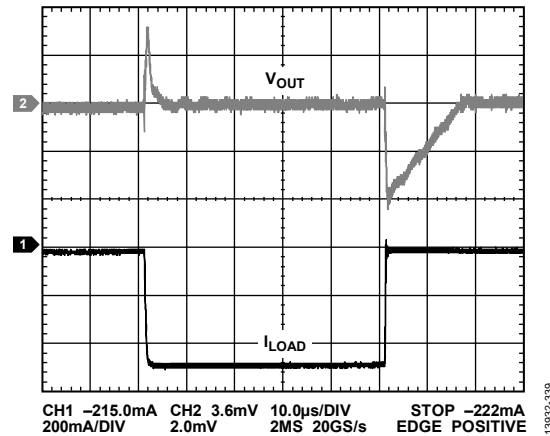

Figure 39. Load Transient Response,  $V_{OUT} = -2.5\text{ V}$ ,  $I_{LOAD} = -10\text{ mA to } -500\text{ mA}$

## THEORY OF OPERATION

The ADP7185 is a low quiescent current, LDO linear regulator that operates from  $-2.0\text{ V}$  to  $-5.5\text{ V}$  and can provide up to  $-500\text{ mA}$  of output current. Total integrated output noise is  $4\text{ }\mu\text{V rms}$  independent of the output voltage, making it ideal for high performance and noise sensitive applications. Shutdown current consumption is  $-7\text{ }\mu\text{A}$  (maximum).

The ADP7185 is optimized for use with a  $4.7\text{ }\mu\text{F}$  ceramic capacitor for excellent transient performance. Using advanced proprietary architecture, the ADP7185 provides ultralow noise and high power supply rejection up to high frequencies of operation. Figure 40 shows the fixed output voltage internal block diagram of the ADP7185, and Figure 41 shows the adjustable output voltage internal block diagram of the ADP7185.

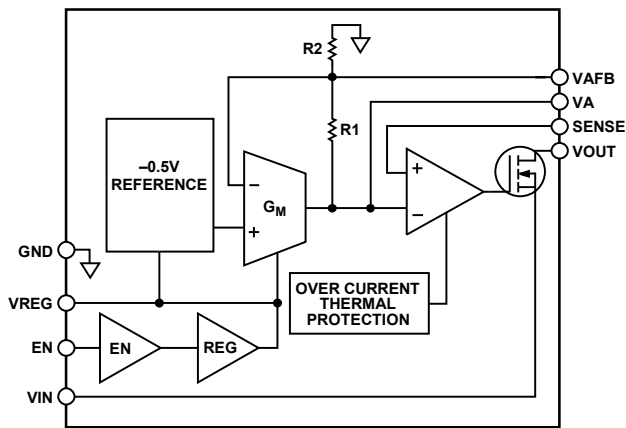

Figure 40. Fixed Output Voltage Internal Block Diagram

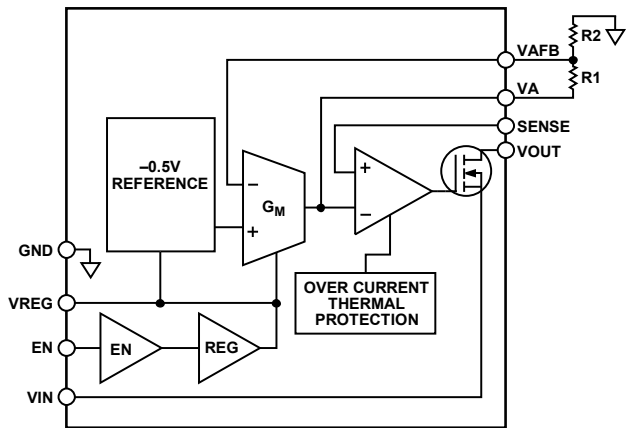

Figure 41. Adjustable Output Voltage Internal Block Diagram

Internally, the ADP7185 consists of a regulator block, reference block,  $G_M$  amplifier, feedback voltage divider, LDO regulator, and an N-channel MOSFET pass transistor. The regulator block produces an internal voltage rail ( $V_{REG}$ ) of  $-1.8\text{ V}$  to serve as the supply voltage for the succeeding internal blocks. The  $G_M$  amplifier produces a reference voltage ( $V_A$ ) used as a reference to the LDO regulator.

For fixed option models, the  $V_A$  voltage is generated through the resistor divider ratio depending on the  $V_{OUT}$  option. For adjustable models, the  $V_A$  voltage generates externally through the  $R1$  and

$R2$  resistors that are connected across the  $VA$  and  $VAFB$  pins. Because the reference voltage to the LDO regulator already adjusts according to the desired  $V_{OUT}$ , the LDO regulator now connects in a buffer configuration for improved noise performance. If the load draws higher current, the LDO regulator pulls the gate of the NMOS device higher towards  $GND$  to allow more current to pass. If the load draws less current, the LDO regulator pulls the gate of the NMOS device lower toward  $-V_{IN}$  to restrict the amount of current passing through the device.

## ADJUSTABLE MODE OPERATION

The adjustable mode version of the ADP7185 has an output that can be set to from  $-0.5\text{ V}$  to  $-4.5\text{ V}$  by an external voltage divider. To calculate the output voltage, use the following equation:

$$V_{OUT} = -0.5\text{ V}(1 + R1/R2) \quad (1)$$

Figure 42 shows an example of an adjustable setting where  $R1 = 280\text{ k}\Omega$  and  $R2 = 49.9\text{ k}\Omega$ , setting the output voltage to  $-3.3\text{ V}$ .

$R2$  must be at least  $10\text{ k}\Omega$  to maximize PSRR performance.

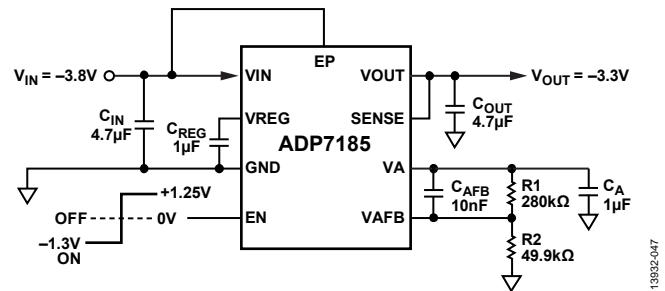

Figure 42. Setting the Adjustable Output Voltage

## ENABLE PIN OPERATION

The ADP7185 uses the EN pin to enable and disable the  $V_{OUT}$  pin under normal operating conditions. When EN is  $+1.25\text{ V}$  above or  $-1.3\text{ V}$  below with respect to  $GND$ ,  $V_{OUT}$  turns on, and when EN is at  $0\text{ V}$ ,  $V_{OUT}$  turns off, as shown in Figure 43. For automatic startup, connect EN to  $V_{IN}$ .

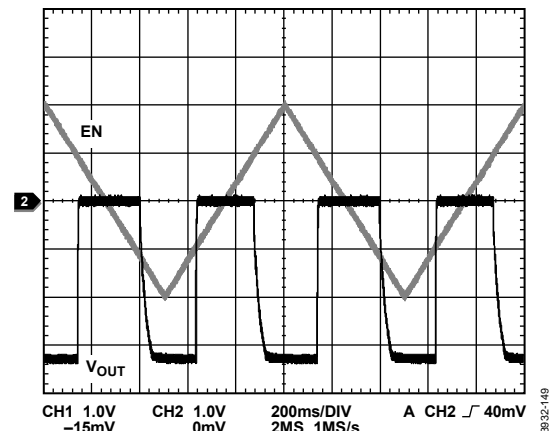

Figure 43. Typical EN Pin Operation

**START-UP TIME**

When the output is enabled, the ADP7185 uses an internal soft start to limit the inrush current. The start-up time for a -1.2 V output is approximately 12 ms from the time the EN active threshold is crossed to the time when the output reaches 90% of its final value (see Figure 44). As shown in Figure 44 and Figure 45, the start-up time is dependent upon the output voltage option and the value of the C<sub>AFB</sub> capacitor.

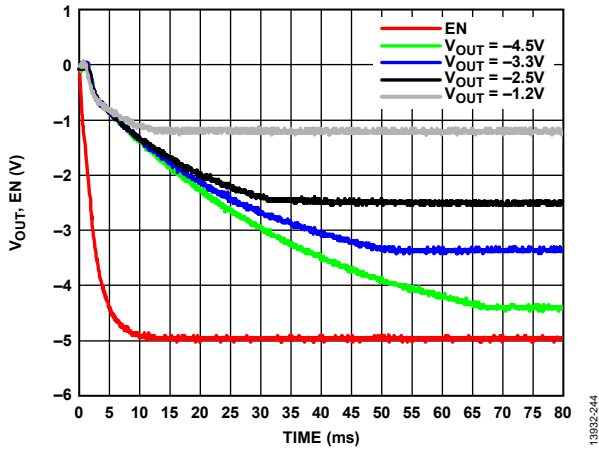

Figure 44. Start-Up Time at Various Output Voltages, C<sub>AFB</sub> = 10 nF, C<sub>A</sub> = 1 μF

The total start-up time depends mostly on the C<sub>A</sub> and C<sub>AFB</sub> values expressed by the τ<sub>1</sub> and τ<sub>2</sub> equations (see Equation 2 and Equation 3). During startup, an internal circuit, G<sub>M,START</sub>, turns on and helps charge C<sub>A</sub> up to 90% of the final value. Estimate the first time constant, τ<sub>1</sub>, due to C<sub>A</sub> by

$$\tau_1 \approx C_A \times ((R1 + R2) // Z_{OUT}) \tag{2}$$

During this time, keep Z<sub>OUT</sub> low to approximately 1 kΩ to allow quick start-up times, keeping τ<sub>1</sub> in the order of 1 ms.

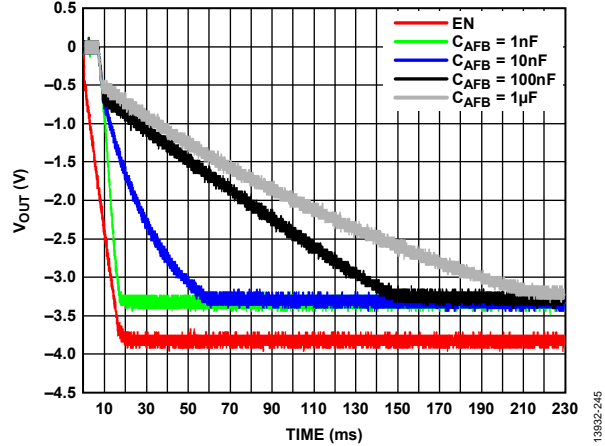

Figure 45. Start-Up Time at Various C<sub>AFB</sub> Capacitor Values, C<sub>A</sub> = 1 μF

A second time constant, τ<sub>2</sub>, is dependent mainly on C<sub>AFB</sub>. Figure 45 shows how the C<sub>AFB</sub> value affects the start-up time. Estimate τ<sub>2</sub> by

$$\tau_2 \approx C_{AFB} \times R1 \tag{3}$$

The R1 value scales vs. the V<sub>OUT</sub> option. Table 6 shows the R1 value depending on the fixed output voltage option, whereas R2 is constant at 500 kΩ. For example, at a fixed V<sub>OUT</sub> = -3.3 V, R1 equals 2.8 MΩ. To keep τ<sub>2</sub> at a minimum, it is recommended that C<sub>AFB</sub> be in the approximately nanofarad range. A typical setup for the ADP7185 is C<sub>AFB</sub> = 10 nF; therefore, τ<sub>2</sub> = 28 ms. The total time constant, τ<sub>TOTAL</sub>, is the sum of τ<sub>1</sub> and τ<sub>2</sub>. At 2.2 × τ<sub>TOTAL</sub>, V<sub>A</sub> is equal to ~90% of the final value. Therefore, for a fixed V<sub>OUT</sub> = -3.3 V, the output voltage is ~90% of the final value after 63.8 ms.

**Table 6. R1 and R2 Values for the Fixed Output Options**

Output Voltage (V)	R1 (Ω)	R2 (kΩ)
-1.2	700 k	500
-2.5	2 M	500
-3.3	2.8 M	500
-4.5	4 M	500

Note that τ<sub>1</sub> and τ<sub>2</sub> are estimates only and do not take into account that G<sub>M</sub> and Z<sub>OUT</sub> dynamically change. It is an accurate estimate of ~90% of the start-up time for the C<sub>AFB</sub> < 10 nF recommended setup, where ~100% of the settling time can easily be achieved. Note that for setups with C<sub>AFB</sub> >> 10 nF, the equation may not hold true anymore. However, it is still a convenient estimate on the amount of time needed to achieve ~100% of the settling time.

## APPLICATIONS INFORMATION

### ADIsimPOWER DESIGN TOOL

The ADIsimPower™ design tool set supports the ADP7185. ADIsimPower is a collection of tools that produce complete power designs optimized for a specific design goal. The tools enable the user to generate a full schematic, bill of materials, and calculate performance in minutes. ADIsimPower can optimize designs for cost, area, efficiency, and parts count, taking into consideration the operating conditions and limitations of the IC and all external components. For more information about, and to obtain ADIsimPower design tools, visit [www.analog.com/ADIsimPower](http://www.analog.com/ADIsimPower).

### CAPACITOR SELECTION

#### Output Capacitor

The ADP7185 operates with small, space-saving ceramic capacitors; however, it also functions with general-purpose capacitors as long as care is taken with regard to the effective series resistance (ESR) value. The ESR of the output capacitor affects the stability of the LDO regulator control loop. A minimum of 4.7  $\mu\text{F}$  capacitance with an ESR of 0.05  $\Omega$  or less is recommended to ensure the stability of the ADP7185. Output capacitance affects the transient response to changes in load currents. Using a larger value for the output capacitance improves the transient response of the ADP7185 to large changes in load current. Figure 46 shows the transient response for an output capacitance value ( $C_{\text{OUT}}$ ) of 4.7  $\mu\text{F}$ .

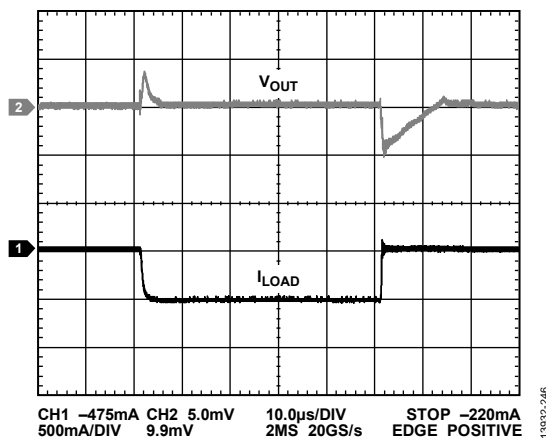

Figure 46. Output Transient Response,  $C_{\text{OUT}} = 4.7 \mu\text{F}$ ,  $V_{\text{OUT}} = -1.2 \text{V}$

#### Input Bypass Capacitor

Connecting a 4.7  $\mu\text{F}$  or greater capacitor from VIN to GND reduces the circuit sensitivity to the PCB layout, especially when long input traces or high source impedance are encountered. When more than 4.7  $\mu\text{F}$  of output capacitance is required, increase the input capacitance to match it.

#### $C_A$ and $C_{\text{AFB}}$ Capacitors

The ultralow output noise of the ADP7185 is achieved by keeping the LDO error amplifier in unity gain and setting the reference voltage equal to the output voltage. In this architecture, the resistor driven by the  $G_M$  amplifier adjusts the reference voltage to the selected output voltage. To ensure the  $G_M$  amplifier stability, the  $C_A$  capacitor is needed to generate the dominant pole and to keep the  $G_M$  amplifier stable across all conditions.  $C_A$  also serves as a dampening capacitor to the inputs of the LDO error amplifier for improved PSRR. However, the LDO output noise scales by the  $G_M$  amplifier amount of gain as a function of the output voltage. To minimize the output voltage noise contributed by the  $G_M$  amplifier, the  $C_{\text{AFB}}$  capacitor must be connected between the VA and VAFB pins to keep the ac gain of the  $G_M$  amplifier in unity.

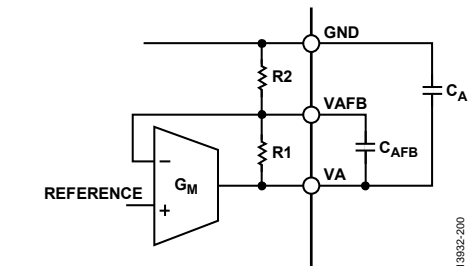

Figure 47.  $C_A$  and  $C_{\text{AFB}}$  Connection to the  $G_M$  Amplifier

#### Input and Output Capacitor Properties

Any good quality ceramic capacitors can be used with the ADP7185 if they meet the minimum capacitance and maximum ESR requirements. Ceramic capacitors are manufactured with a variety of dielectrics, each with different behavior over temperature and applied voltage. Capacitors must have a dielectric adequate to ensure the minimum capacitance over the necessary temperature range and dc bias conditions. X5R and X7R dielectrics with a voltage rating from 6.3 V to 10 V are recommended. Due to their poor temperature and dc bias characteristics, Y5V and Z5U dielectrics are not recommended.

Figure 48 shows the change in capacitance vs. the dc bias voltage characteristics of a 0805 case, 4.7  $\mu\text{F}$ , 10 V, X5R capacitor. The capacitor size and voltage ratings strongly influence the voltage stability of a capacitor. In general, a capacitor in a larger package or with a higher voltage rating exhibits improved stability. The temperature variation of the X5R dielectric is about  $\pm 15\%$  over the  $-55^\circ\text{C}$  to  $+85^\circ\text{C}$  temperature range and is not a function of package size or voltage rating.

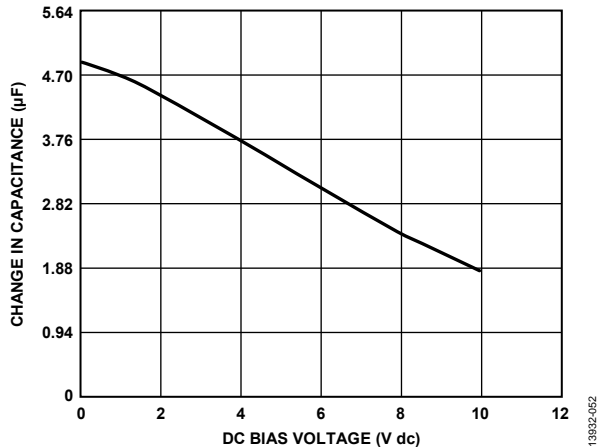

Figure 48. Change in Capacitance vs. DC Bias Voltage

Use Equation 4 to determine the worst-case capacitance, accounting for capacitor variation over temperature, component tolerance, and voltage.

$$C_{EFF} = C_{OUT} \times (1 - TEMP_{CO}) \times (1 - TOL) \quad (4)$$

where:

$C_{EFF}$  is the effective capacitance at the operating voltage.

$C_{OUT}$  is the output capacitor.

$TEMP_{CO}$  is the worst-case capacitor temperature coefficient.

$TOL$  is the worst-case component tolerance.

In this example, the worst-case temperature coefficient ( $TEMP_{CO}$ ) over  $-55^\circ\text{C}$  to  $+85^\circ\text{C}$  is assumed to be 15% for an X5R dielectric. The tolerance of the capacitor ( $TOL$ ) is assumed to be 10%, and  $C_{OUT} = 4.7 \mu\text{F}$  at 1.0 V.

Substituting these values in Equation 4 yields

$$C_{EFF} = 4.7 \mu\text{F} \times (1 - 0.15) \times (1 - 0.1) = 3.6 \mu\text{F}$$

Therefore, the capacitor chosen in this example meets the minimum capacitance requirement of the LDO over temperature and tolerance at the chosen output voltage.

To guarantee the performance of the ADP7185, it is imperative to evaluate the effects of dc bias, temperature, and tolerances on the behavior of the capacitors for each application.

### UNDERVOLTAGE LOCKOUT (UVLO)

The UVLO circuitry protects the system from power supply brownouts. If the input voltage on  $V_{IN}$  is more positive than the minimum  $-1.58 \text{ V}$  UVLO falling threshold, the LDO output shuts down. The LDO enables again when the voltage to  $V_{IN}$  is more negative than the maximum  $-1.77 \text{ V}$  UVLO rising threshold.

A typical hysteresis of 90 mV within the UVLO circuitry prevents the device from oscillating due to the noises from  $V_{IN}$ .

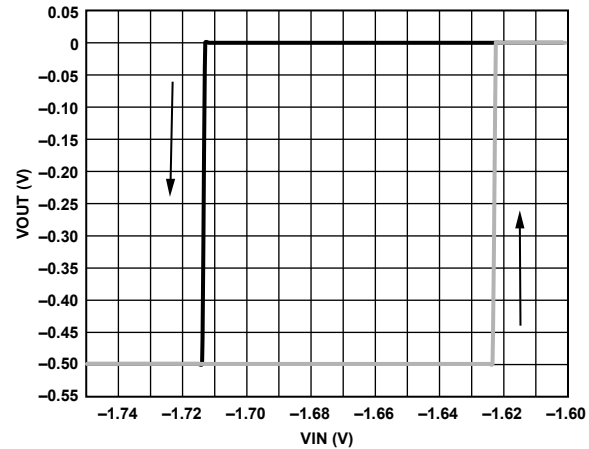

Figure 49. Typical UVLO Behavior,  $V_{OUT} = -0.5 \text{ V}$

### CURRENT-LIMIT AND THERMAL OVERLOAD PROTECTION

The ADP7185 is protected against damage due to excessive power dissipation by current-limit and thermal overload protection circuits. The ADP7185 is designed to reach current limit when the output load reaches  $-900 \text{ mA}$  (typical). When the output load exceeds  $-900 \text{ mA}$ , the output voltage is reduced to maintain a constant current limit.

Thermal overload protection is included, which limits the junction temperature to a maximum of  $150^\circ\text{C}$  (typical). Under extreme conditions (that is, high ambient temperature and power dissipation) when the junction temperature begins to rise above  $150^\circ\text{C}$ , the output is turned off, reducing the output current to zero. When the junction temperature drops below  $135^\circ\text{C}$  (typical), the output is turned on again, and the output current is restored to its nominal value.

Consider the case where a hard short from  $V_{OUT}$  to GND occurs. At first, the ADP7185 reaches current limit so that only  $-900 \text{ mA}$  is conducted into the short. If self-heating of the junction becomes great enough to cause its temperature to rise above  $150^\circ\text{C}$ , thermal shutdown activates, turning off the output and reducing the output current to zero. As the junction temperature cools and drops below  $135^\circ\text{C}$ , the output turns on and conducts  $-900 \text{ mA}$  into the short, again causing the junction temperature to rise above  $150^\circ\text{C}$ . This thermal oscillation between  $135^\circ\text{C}$  and  $150^\circ\text{C}$  causes a current oscillation between  $-900 \text{ mA}$  and  $0 \text{ A}$  that continues as long as the short remains at the output. Current-limit and thermal overload protections protect the device against accidental overload conditions. For reliable operation, externally limit device power dissipation so that junction temperatures do not exceed  $125^\circ\text{C}$ .



**THERMAL CONSIDERATIONS**

In applications with a low input to output voltage differential, the ADP7185 does not dissipate much heat. However, in applications with high ambient temperature and/or high input voltage, the heat dissipated in the package may become large enough to cause the junction temperature of the die to exceed the maximum junction temperature of 125°C.

When the junction temperature exceeds 150°C, the converter enters thermal shutdown. The converter recovers only after the junction temperature decreases below 135°C to prevent any permanent damage. Therefore, thermal analysis for the chosen application is important to guarantee reliable performance over all conditions. The junction temperature of the die is the sum of the ambient temperature of the environment and the temperature rise of the package due to the power dissipation, as shown in Equation 5.

To guarantee reliable operation, the junction temperature of the ADP7185 must not exceed 125°C. To ensure that the junction temperature stays below this maximum value, the user must be aware of the parameters that contribute to junction temperature changes. These parameters include ambient temperature, power dissipation in the power device, and thermal resistances between the junction and ambient air ( $\theta_{JA}$ ). The  $\theta_{JA}$  number is dependent on the package assembly compounds that are used, and the amount of copper used to solder the package VIN pins to the PCB.

Table 7 shows the typical  $\theta_{JA}$  values for the 8-lead LFCSP package and for various PCB copper sizes.

**Table 7. Typical  $\theta_{JA}$  Values**

Copper Size (mm <sup>2</sup> )	$\theta_{JA}$ (°C/W), 8-Lead LFCSP
25	146.6
100	105.4
500	75.38
1000	65.16
6400	53.5

Calculate the junction temperatures of the ADP7185 by

$$T_J = T_A + (P_D \times \theta_{JA}) \tag{5}$$

where:

$T_A$  is the ambient temperature.

$P_D$  is the power dissipation in the die, given by

$$P_D = ((V_{IN} - V_{OUT}) \times I_{LOAD}) + (V_{IN} \times I_{GND}) \tag{6}$$

where:

$V_{IN}$  and  $V_{OUT}$  are the input and output voltages, respectively.

$I_{LOAD}$  is the load current.

$I_{GND}$  is the ground current.

Power dissipation due to ground current is quite small and can be ignored. Therefore, the junction temperature equation simplifies to

$$T_J = T_A + (((V_{IN} - V_{OUT}) \times I_{LOAD}) \times \theta_{JA}) \tag{7}$$

As shown in Equation 7, for a given ambient temperature, input to output voltage differential, and continuous load current, there exists a minimum copper size requirement for the PCB to ensure that the junction temperature does not rise above 125°C.

Figure 50 to Figure 52 show the junction temperature calculations for the different ambient temperatures, power dissipation, and areas of the PCB copper.

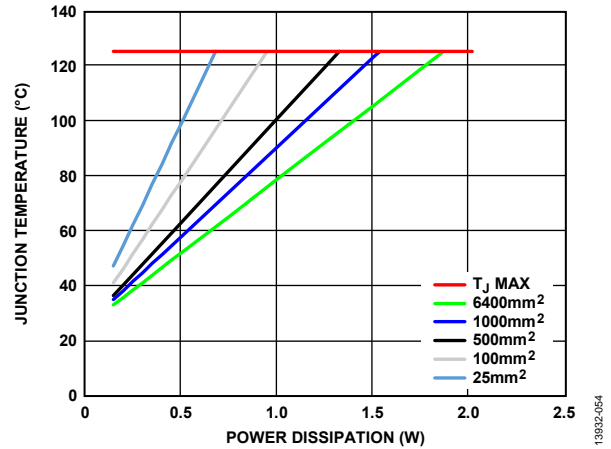

Figure 50. Junction Temperature vs. Total Power Dissipation,  $T_A = -25^\circ\text{C}$

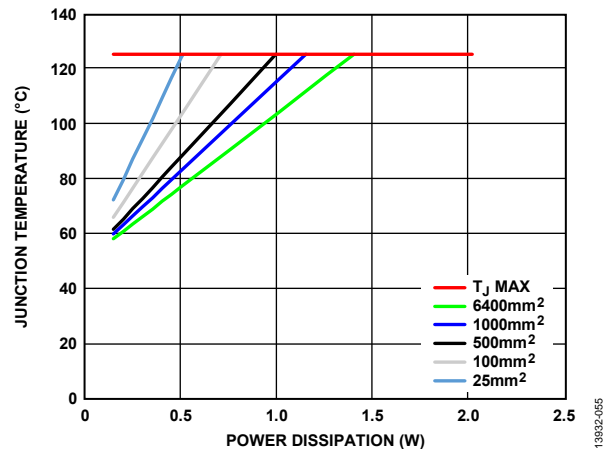

Figure 51. Junction Temperature vs. Total Power Dissipation,  $T_A = -50^\circ\text{C}$

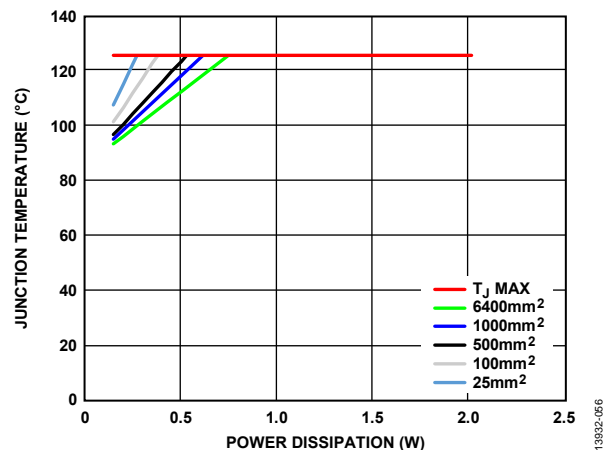

Figure 52. Junction Temperature vs. Total Power Dissipation,  $T_A = -85^\circ\text{C}$

**PCB LAYOUT CONSIDERATIONS**

Place the input capacitor ( $C_{IN}$ ) as close as possible to the VIN and GND pins. Place the output capacitor ( $C_{OUT}$ ) as close as possible to the VOUT and GND pins. Place bypass capacitors ( $C_A$  and  $C_{REG}$ ) close to their respective pins (VA and VREG) and GND. Use of 0805 or 0603 size capacitors and resistors achieves the smallest possible footprint solution on boards where area is limited. Connect the exposed pad to VIN.

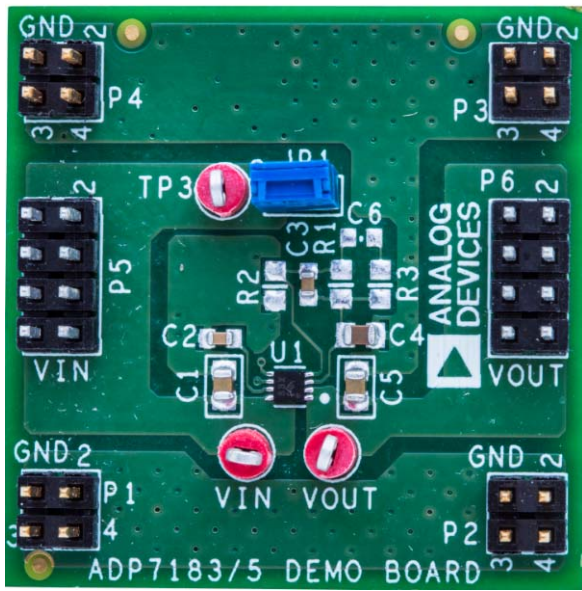

Figure 53. Evaluation Board

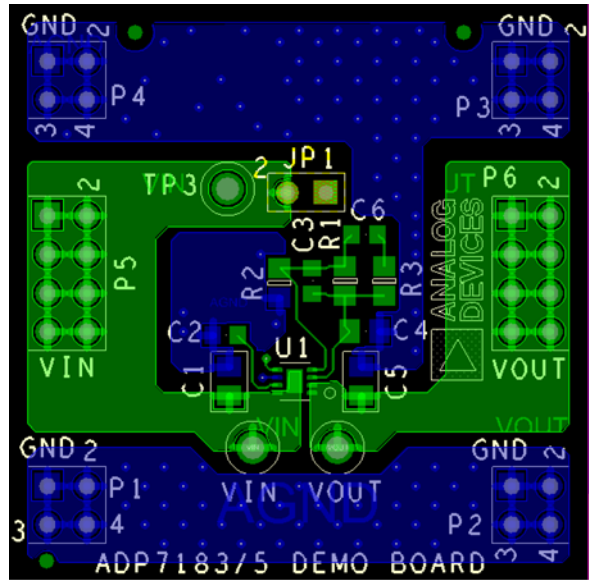

Figure 54. Typical Board Layout, Top Side

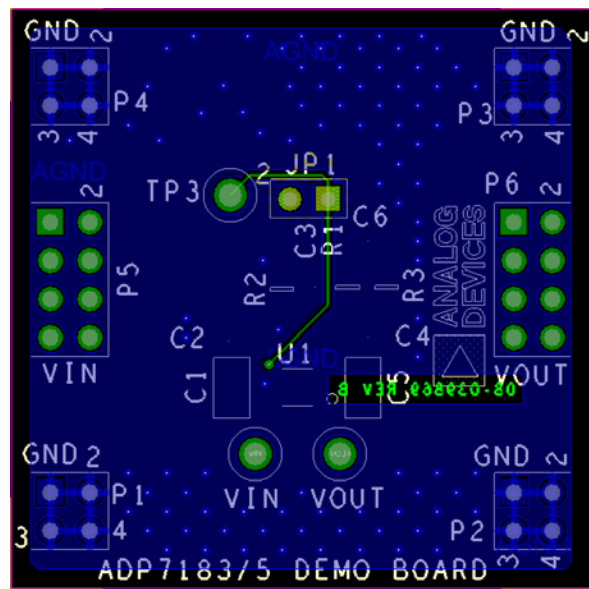

Figure 55. Typical Board Layout, Bottom Side

OUTLINE DIMENSIONS

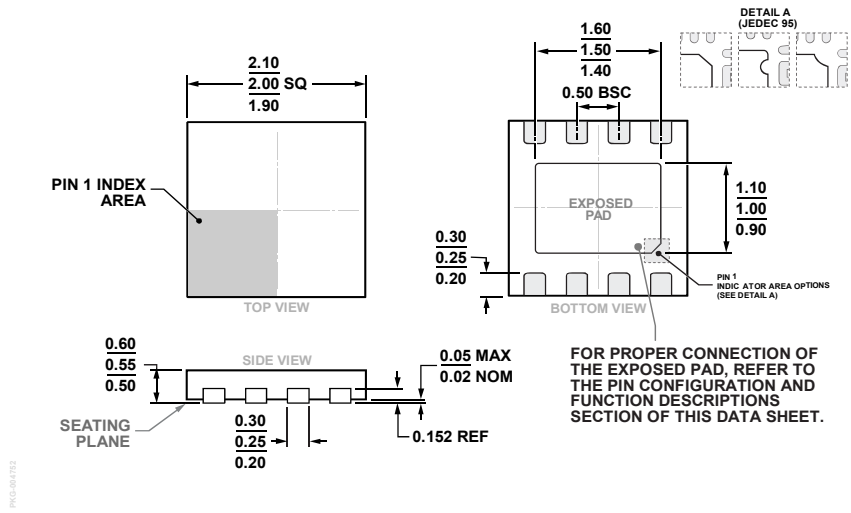

Figure 56. 8-Lead Lead Frame Chip Scale Package [LFCSP]  
 2 mm × 2 mm Body and 0.55 mm Package Height  
 (CP-8-27)  
 Dimensions shown in millimeters

ORDERING GUIDE

Model <sup>1</sup>	Temperature Range	Output Voltage (V) <sup>2</sup>	Package Description	Package Option	Branding
ADP7185ACPZN0.5-R7	-40°C to +125°C	-0.5	8-Lead LFCSP	CP-8-27	LTS
ADP7185ACPZN1.0-R7	-40°C to +125°C	-1.0	8-Lead LFCSP	CP-8-27	LTT
ADP7185ACPZN1.2-R7	-40°C to +125°C	-1.2	8-Lead LFCSP	CP-8-27	LTU
ADP7185ACPZN1.5-R7	-40°C to +125°C	-1.5	8-Lead LFCSP	CP-8-27	LTV
ADP7185ACPZN1.8-R7	-40°C to +125°C	-1.8	8-Lead LFCSP	CP-8-27	LTW
ADP7185ACPZN2.0-R7	-40°C to +125°C	-2.0	8-Lead LFCSP	CP-8-27	LTX
ADP7185ACPZN2.5-R7	-40°C to +125°C	-2.5	8-Lead LFCSP	CP-8-27	LTY
ADP7185ACPZN3.0-R7	-40°C to +125°C	-3.0	8-Lead LFCSP	CP-8-27	LTZ
ADP7185ACPZN3.3-R7	-40°C to +125°C	-3.3	8-Lead LFCSP	CP-8-27	LU0
ADP7185ACPZN-R7	-40°C to +125°C	Adjustable	8-Lead LFCSP	CP-8-27	LU1
ADP7185-3.3-EVALZ		-3.3	Evaluation Board for the Fixed Voltage Option		
ADP7185-ADJ-EVALZ		-2.5	Evaluation Board for the Adjustable Voltage Option		

<sup>1</sup> Z = RoHS Compliant Part.

<sup>2</sup> For additional voltage options, contact a local Analog Devices Inc., sales or distribution representative.



Компания «ЭлектроПласт» предлагает заключение долгосрочных отношений при поставках импортных электронных компонентов на взаимовыгодных условиях!

Наши преимущества:

- Оперативные поставки широкого спектра электронных компонентов отечественного и импортного производства напрямую от производителей и с крупнейших мировых складов;
- Поставка более 17-ти миллионов наименований электронных компонентов;
- Поставка сложных, дефицитных, либо снятых с производства позиций;
- Оперативные сроки поставки под заказ (от 5 рабочих дней);
- Экспресс доставка в любую точку России;
- Техническая поддержка проекта, помощь в подборе аналогов, поставка прототипов;
- Система менеджмента качества сертифицирована по Международному стандарту ISO 9001;
- Лицензия ФСБ на осуществление работ с использованием сведений, составляющих государственную тайну;
- Поставка специализированных компонентов (Xilinx, Altera, Analog Devices, Intersil, Interpoint, Microsemi, Aeroflex, Peregrine, Syfer, Eurofarad, Texas Instrument, Miteq, Cobham, E2V, MA-COM, Hittite, Mini-Circuits, General Dynamics и др.);

Помимо этого, одним из направлений компании «ЭлектроПласт» является направление «Источники питания». Мы предлагаем Вам помощь Конструкторского отдела:

- Подбор оптимального решения, техническое обоснование при выборе компонента;
- Подбор аналогов;
- Консультации по применению компонента;
- Поставка образцов и прототипов;
- Техническая поддержка проекта;
- Защита от снятия компонента с производства.



#### Как с нами связаться

**Телефон:** 8 (812) 309 58 32 (многоканальный)

**Факс:** 8 (812) 320-02-42

**Электронная почта:** [org@eplast1.ru](mailto:org@eplast1.ru)

**Адрес:** 198099, г. Санкт-Петербург, ул. Калинина, дом 2, корпус 4, литера А.