

Fully Integrated Proximity and Ambient Light Sensor With Infrared Emitter, I²C Interface, and Interrupt Function (with multiple slave addresses)

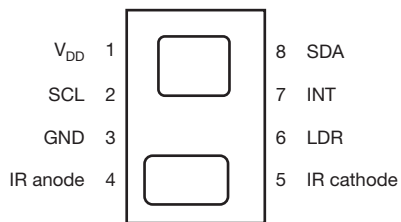

DESCRIPTION

VCNL4030X01 integrates a proximity sensor (PS), ambient light sensor (ALS), and a high power IRED into one small package. It incorporates photodiodes, amplifiers, and analog to digital converting circuits into a single chip by CMOS process. The 16-bit high resolution ALS for excellent sensing capabilities with sufficient selections to fulfill most applications whether dark or high transparency lens design. Both ALS and PS offer a programmable interrupt with individual high and low thresholds offers the power savings on the microcontroller.

The proximity sensor features an intelligent cancellation scheme, so that cross talk is eliminated effectively. The proximity's smart persistence feature prevents the misjudgment of proximity sensing with a fast response time. Active force mode, one time trigger by one instruction, offers more design flexibility to fulfill different kinds of applications with more power savings.

The adoption of patented Filtron™ technology achieves the closest ambient light spectral sensitivity to real human eye responses and offers the best background light cancellation capability (including sunlight) without utilizing the microcontrollers' resources. VCNL4030X01 provides an excellent temperature compensation capability for keeping the output stable over temperature. ALS and PS functions are easily operated via the simple command format of I²C (SMBus compatible) interface protocol. Operating voltage ranges from 2.5 V to 3.6 V. VCNL4030X01 is packaged in a lead-free 8-pin QFN package, which offers the best market-proven reliability quality.

FEATURES

- Package type: surface-mount
- Dimensions (L x W x H in mm): 4.0 x 2.36 x 0.75
- AEC-Q101 qualified
- Integrated modules: infrared emitter (IRED), ambient light sensor (ALS), proximity sensor (PS), and signal conditioning IC
- Operates ALS and PS in parallel structure
- Filtron™ technology adoption for robust background light cancellation
- Low power consumption I²C (SMBus compatible) interface
- Orderable in four different slave addresses
- Output type: I²C bus (ALS / PS)
- Operation voltage: 2.5 V to 3.6 V
- Floor life: 168 h, MSL 3, according to J-STD-020
- Material categorization: for definitions of compliance please see www.vishay.com/doc?99912



PROXIMITY FUNCTION

- Immunity to red glow (940 nm IRED)
- Programmable IRED sink current
- Intelligent cancellation to reduce cross talk phenomenon
- Smart persistence scheme to reduce PS response time
- Selectable for 12- / 16-bit PS output data

AMBIENT LIGHT FUNCTION

- High accuracy of ALS $\pm 10\%$
- Fluorescent light flicker immunity
- Spectrum close to real human eye responses
- Selectable maximum detection range (262 / 524 / 1048 / 2096 / 4192) lux with highest sensitivity 0.004 lux/step

INTERRUPT

- Programmable interrupt function for ALS and PS with upper and lower thresholds
- Adjustable persistence to prevent false triggers for ALS and PS

APPLICATIONS

- Proximity sensor for
 - Mobile devices (e.g. smart phones, tablets) for touch screen locking, power saving etc.
 - Automotive for presence detection
- Integrated ambient light function for display / keypad contrast control and dimming of mobile devices
- Collision detection in robots and toys
- Proximity / optical switch for consumer, computing, automotive and industrial devices, and displays (like notebooks, tablet PCs, and automotive touch panels)
- Dimming control for consumer, computing, industrial, and automotive displays



PRODUCT SUMMARY								
PART NUMBER	OPERATING RANGE (mm)	OPERATING VOLTAGE RANGE (V)	I ² C BUS VOLTAGE RANGE (V)	IRED PULSE CURRENT (mA) ⁽¹⁾	AMBIENT LIGHT RANGE (lx)	AMBIENT LIGHT RESOLUTION (lx)	OUTPUT CODE	ADC RESOLUTION PROXIMITY / AMBIENT LIGHT
VCNL4030X01	0 to 300	2.5 to 3.6	1.8 to 5	200	0.004 to 4192	0.004	16 bit, I ² C	16 bit / 16 bit

Note⁽¹⁾ Adjustable through I²C interface

ORDERING INFORMATION			
ORDERING CODE	PACKAGING	VOLUME ⁽¹⁾	REMARKS
VCNL4030X01-GS08	Tape and reel	MOQ: 3300 pcs	4.0 mm x 2.36 mm x 0.75 mm
VCNL4030X01-GS18		MOQ: 13 000 pcs	
VCNL40301X01-GS08		MOQ: 3300 pcs	
VCNL40301X01-GS18		MOQ: 13 000 pcs	
VCNL40302X01-GS08		MOQ: 3300 pcs	
VCNL40302X01-GS18		MOQ: 13 000 pcs	
VCNL40303X01-GS08		MOQ: 3300 pcs	
VCNL40303X01-GS18		MOQ: 13 000 pcs	

Note⁽¹⁾ MOQ: minimum order quantity

SLAVE ADDRESS OPTIONS	
ORDERING CODE	SLAVE ADDRESS (7 bit)
VCNL4030X01-GS08	0x60
VCNL4030X01-GS18	
VCNL40301X01-GS08	0x51
VCNL40301X01-GS18	
VCNL40302X01-GS08	0x40
VCNL40302X01-GS18	
VCNL40303X01-GS08	0x41
VCNL40303X01-GS18	

ABSOLUTE MAXIMUM RATINGS (T _{amb} = 25 °C, unless otherwise specified)					
PARAMETER	TEST CONDITION	SYMBOL	MIN.	MAX.	UNIT
Supply voltage		V _{DD}	2.5	3.6	V
Operation temperature range		T _{amb}	-40	+105	°C
Storage temperature range		T _{stg}	-40	+110	°C

RECOMMENDED OPERATING CONDITIONS (T _{amb} = 25 °C, unless otherwise specified)					
PARAMETER	TEST CONDITION	SYMBOL	MIN.	MAX.	UNIT
Supply voltage		V _{DD}	2.5	3.6	V
Operation temperature range		T _{amb}	-40	+105	°C
I ² C bus operating frequency		f _(I2CCLK)	10	400	kHz

PIN DESCRIPTIONS			
PIN ASSIGNMENT	SYMBOL	TYPE	FUNCTION
1	V _{DD}	I	Power supply input
2	SCL	I	I ² C digital bus clock input
3	GND	I	Ground
4	IR ANODE	I	Anode for IRED
5	IR CATHODE	I	Cathode (IRED) connection
6	LDR	I	IRED driver input
7	INT	O	Interrupt pin
8	SDA	I / O (open drain)	I ² C data bus data input / output

BLOCK DIAGRAM

Fig. 1 - Detailed Block Diagram



BASIC CHARACTERISTICS ($T_{amb} = 25\text{ }^{\circ}\text{C}$, unless otherwise specified)							
PARAMETER	TEST CONDITION	SYMBOL	MIN.	TYP.	MAX.	UNIT	
Supply voltage		V_{DD}	2.5	-	3.6	V	
Supply current	Excluded LED driving	I_{DD}	-	300	-	μA	
	Light condition = dark, $V_{DD} = 3.3\text{ V}$	$I_{DD}(\text{SD})$	-	0.2	-	μA	
I ² C supply voltage		$V_{PULL\ UP}$	1.8	-	5.0	V	
ALS shut down	ALS disable, PS enable	I_{ALSSD}	-	200	-	μA	
PS shut down	ALS enable, PS disable	I_{PSSD}	-	260	-	μA	
I ² C signal input	Logic high	$V_{DD} = 3.3\text{ V}$	V_{IH}	1.55	-	-	V
	Logic low		V_{IL}	-	-	0.4	
	Logic high	$V_{DD} = 2.6\text{ V}$	V_{IH}	1.4	-	-	V
	Logic low		V_{IL}	-	-	0.4	
Peak sensitivity wavelength of ALS		λ_p	-	550	-	nm	
Peak sensitivity wavelength of PS		λ_p	-	850	-	nm	
Full ALS counts	16-bit resolution		-	-	65 535	steps	
Full PS counts	12-bit / 16-bit resolution		-	-	4096 / 65 535	steps	
ALS sensing tolerance	White LED light source		-	-	± 10	%	
Detectable intensity	Minimum	ALS_IT = 800 ms, 1 step ⁽¹⁾⁽²⁾	-	0.004	-	lx	
	Maximum	ALS_IT = 50 ms, 65 535 step ⁽¹⁾⁽²⁾	-	4192	-		
ALS dark offset	ALS_IT = 50 ms, normal sensitivity ⁽¹⁾		0	-	3	steps	
PS detection range	Kodak gray card		0	-	300	mm	
Operating temperature range		T_{amb}	-40	-	+105	$^{\circ}\text{C}$	
LED_Anode voltage			-	-	5.0	V	
IRED driving current	⁽³⁾		-	200	-	mA	

Notes

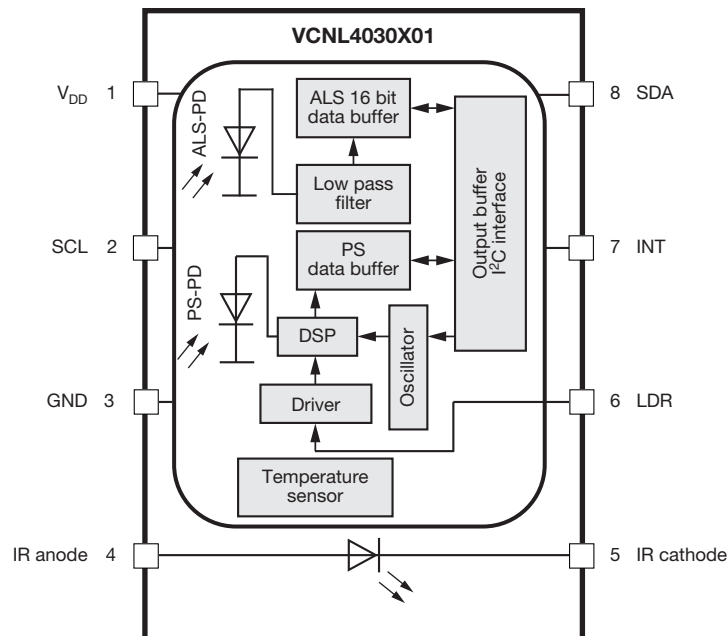
- ⁽¹⁾ Test condition: $V_{DD} = 3.3\text{ V}$, temperature: $25\text{ }^{\circ}\text{C}$
⁽²⁾ Maximum detection range to ambient light can be determined by ALS refresh time adjustment. Refer to table "ALS Resolution and Maximum Detection Range"
⁽³⁾ Programmable between 50 mA and 200 mA; based on IRED on / off duty ratio = 1/40, 1/80, 1/160, and 1/320

I²C BUS TIMING CHARACTERISTICS ($T_{amb} = 25\text{ }^{\circ}\text{C}$, unless otherwise specified)						
PARAMETER	SYMBOL	STANDARD MODE		FAST MODE		UNIT
		MIN.	MAX.	MIN.	MAX.	
Clock frequency	$f_{(I2CCLK)}$	10	100	10	400	kHz
Bus free time between start and stop condition	$t_{(BUF)}$	4.7	-	1.3	-	μs
Hold time after (repeated) start condition; after this period, the first clock is generated	$t_{(HDSTA)}$	4.0	-	0.6	-	μs
Repeated start condition setup time	$t_{(SUSTA)}$	4.7	-	0.6	-	μs
Stop condition setup time	$t_{(SUSTO)}$	4.0	-	0.6	-	μs
Data hold time	$t_{(HDDAT)}$	-	3450	-	900	ns
Data setup time	$t_{(SUDAT)}$	250	-	100	-	ns
I ² C clock (SCK) low period	$t_{(LOW)}$	4.7	-	1.3	-	μs
I ² C clock (SCK) high period	$t_{(HIGH)}$	4.0	-	0.6	-	μs
Clock / data fall time	t_f	-	300	-	300	ns
Clock / data rise time	t_r	-	1000	-	300	ns

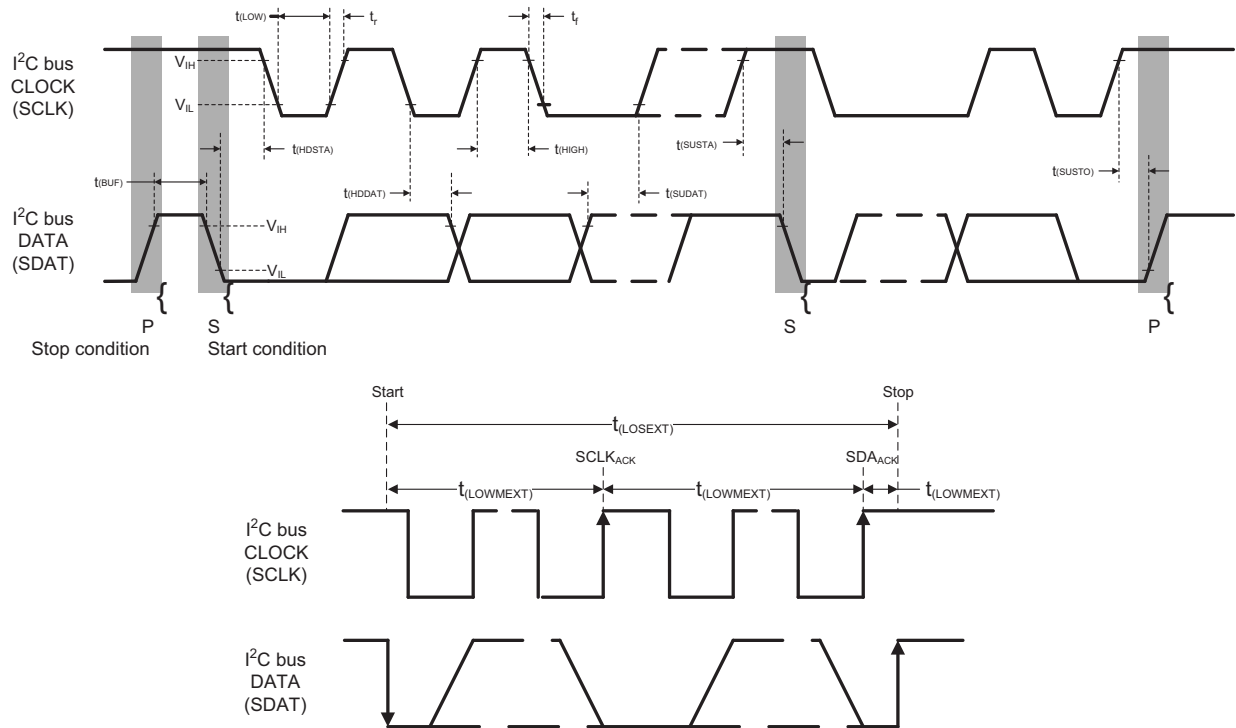
 Fig. 2 - I²C Bus Timing Diagram

PARAMETER TIMING INFORMATION

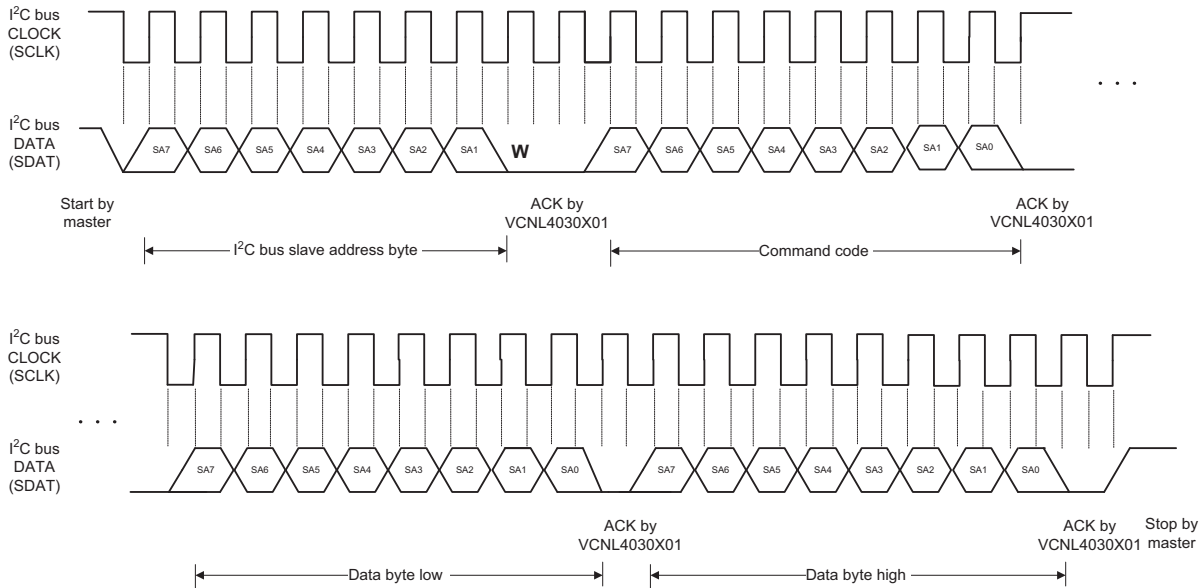

Fig. 3 - I²C Bus Timing for Sending Word Command Format

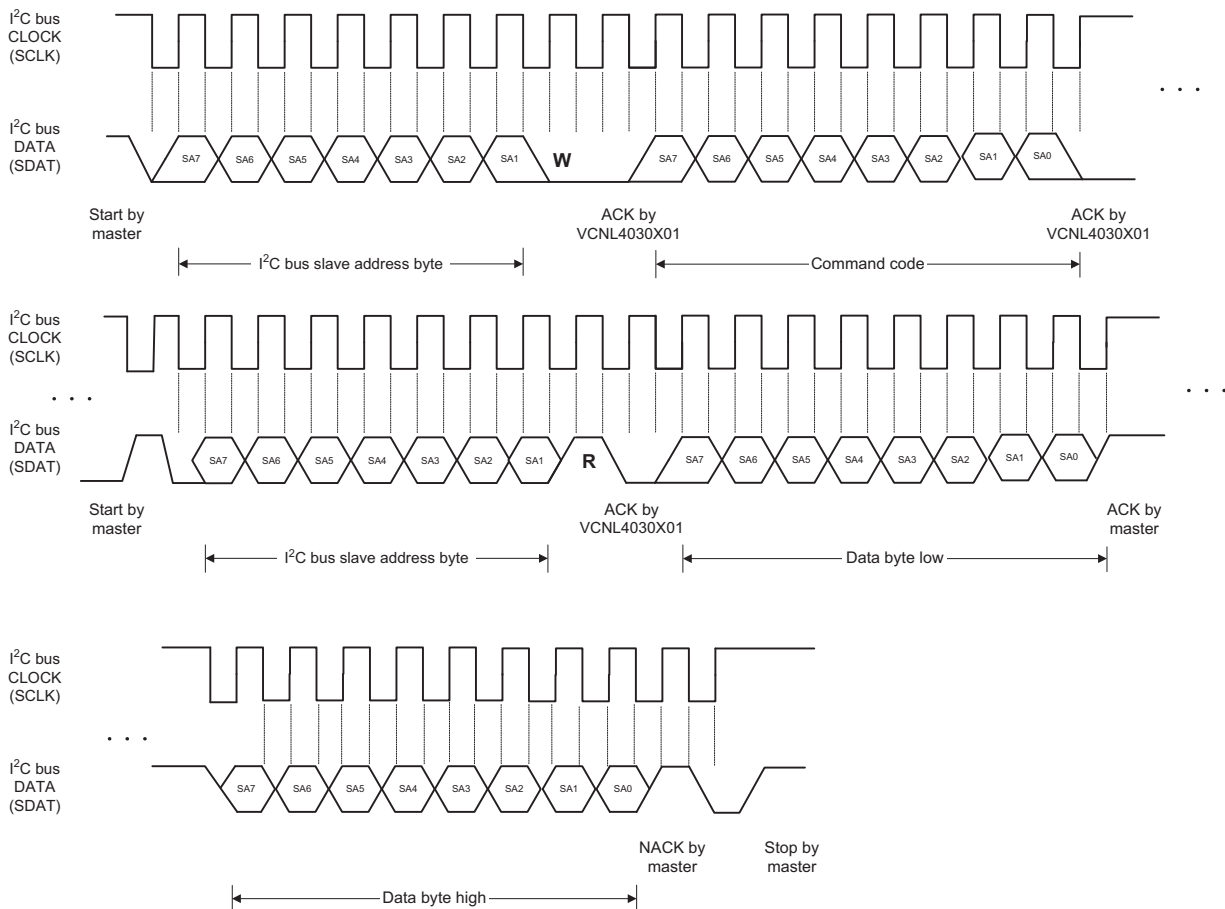

Fig. 4 - I²C Bus Timing for Receiving Word Command Format

TYPICAL PERFORMANCE CHARACTERISTICS ($T_{amb} = 25\text{ }^{\circ}\text{C}$, unless otherwise specified)

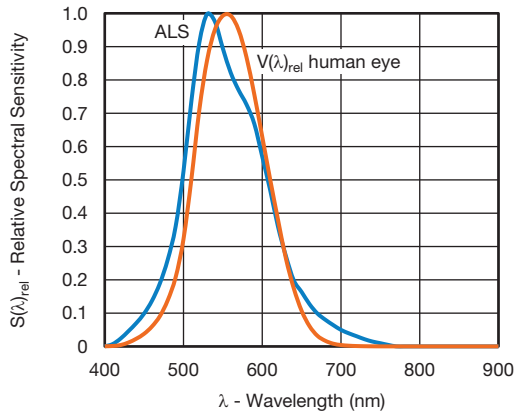

Fig. 5 - Normalized Spectral Response (ALS channel)

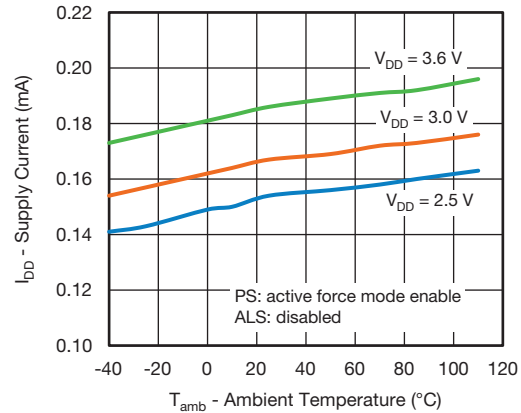

Fig. 8 - Supply Current vs. Ambient Temperature With Only PS = Active

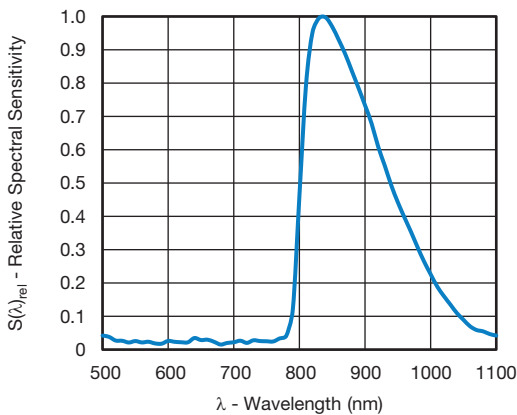

Fig. 6 - Normalized Spectral Response (PS channel)

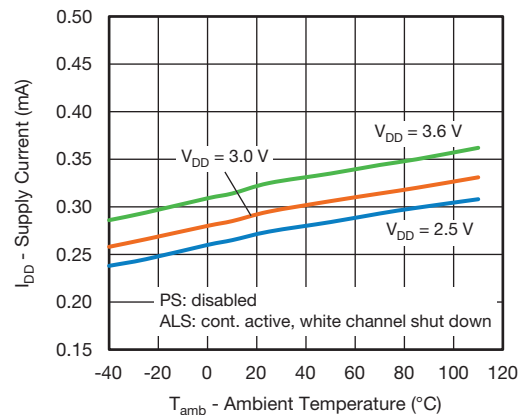

Fig. 9 - Supply Current vs. Ambient Temperature With Only ALS = Active

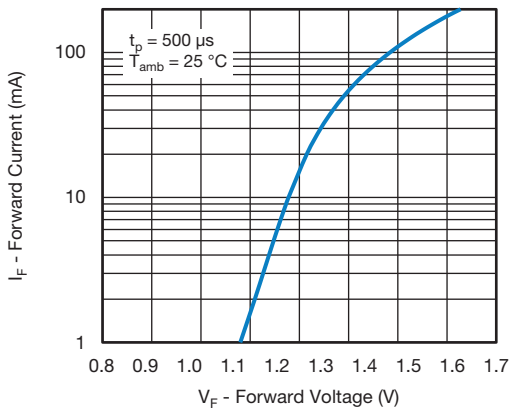

Fig. 7 - Forward Current $I_F = f(V_F)$ for LED

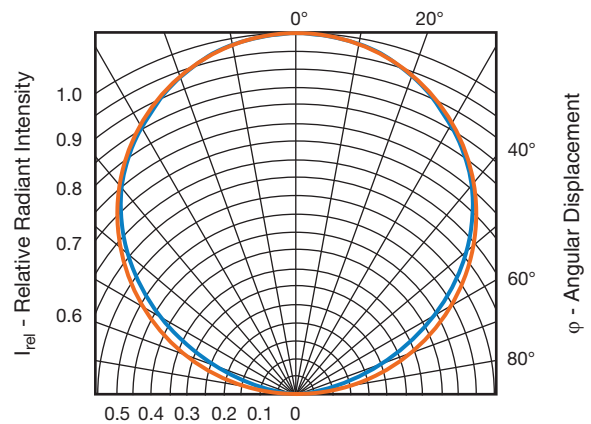

Fig. 10 - Relative Radiant Intensity Emitter vs. Angular Displacement

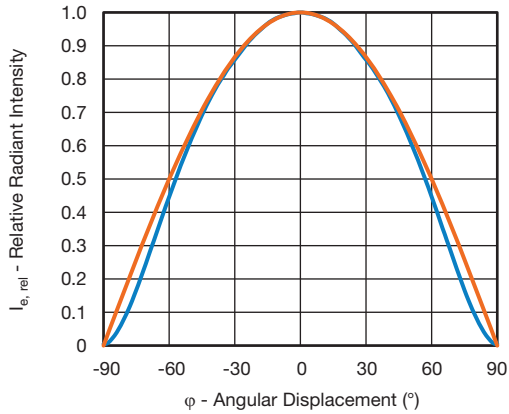

Fig. 11 - Relative Radiant Intensity Emitter vs. Angular Displacement

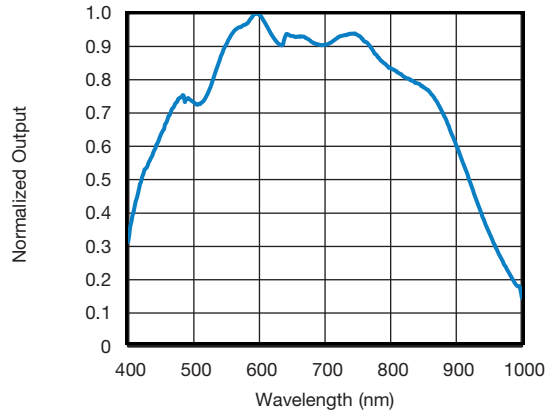

Fig. 14 - White Channel Spectral Response

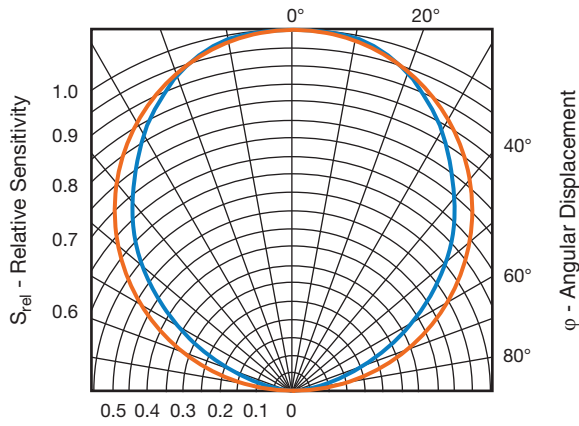

Fig. 12 - Relative Sensitivity vs. Angular Displacement (ALS)

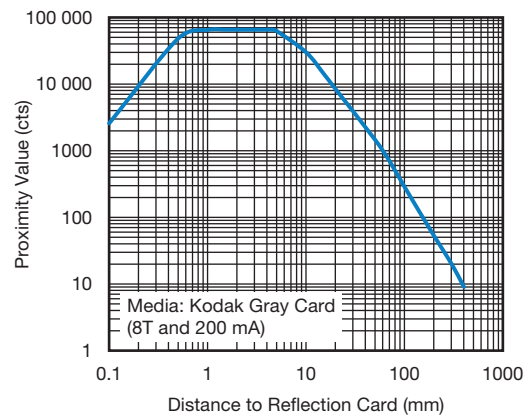

Fig. 15 - Proximity Value vs. Distance to Reflecting Card

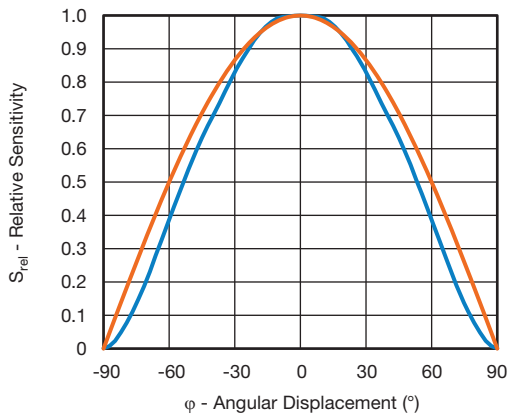

Fig. 13 - Relative Sensitivity vs. Angular Displacement

APPLICATION INFORMATION
Pin Connection with the Host

VCNL4030X01 integrates proximity sensor, ambient light Sensor, and IRED all together with I²C interface. It is very easy for the baseband (CPU) to access PS and ALS output data via I²C interface without extra software algorithms. The hardware schematic is shown in the following diagram.

Two additional capacitors in the circuit can be used for the following purposes: (1) the 0.1 μ F capacitor near the V_{DD} pin is used for power supply noise rejection, (2) the 2.2 μ F capacitor - connected to the anode - is used to prevent the IRED voltage from instantly dropping when the IRED is turned on, and (3) 2.2 k Ω is suitable for the pull up resistor of I²C except for the 8.2 k Ω applied on the INT pin.

Note

- IR cathode and LDR: pins need to be connected together externally

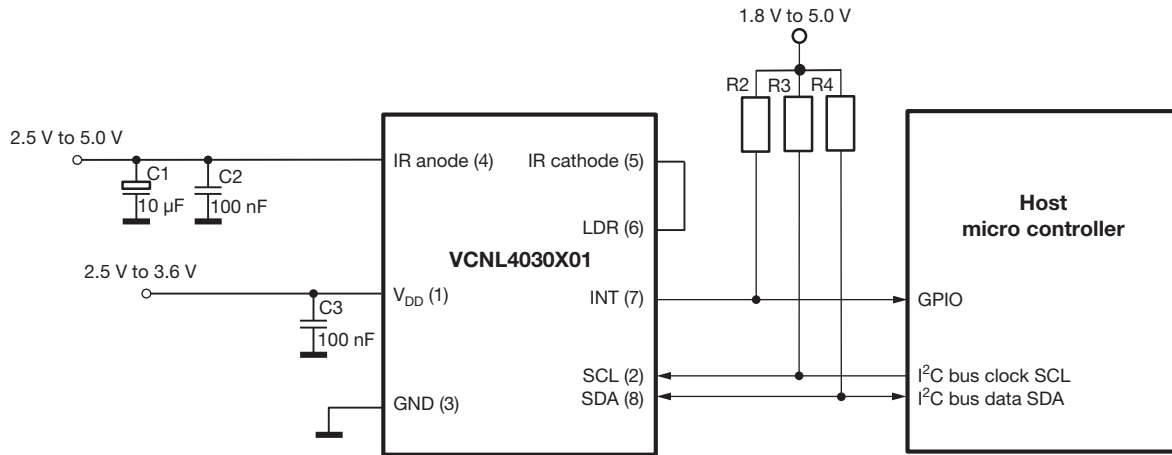

Fig. 16 - Circuitry with Two Separate Power Supply Sources



Digital Interface

VCNL4030X01 is available in four different salve addresses (0x60, 0x51, 0x40, and 0x41). Please refer to the table "Salve Address Options" at the beginning of the datasheet for an overview of the corresponding ordering codes. All operations can be controlled by the command register. The simple command structure helps users easily program the operation setting and latch the light data from VCNL4030X01. As Fig. 17 shows, VCNL4030X01's I2C command format is simple for read and write operations between VCNL4030X01 and the host. The white sections indicate host activity and the gray sections indicate VCNL4030X01's acknowledgement of the host access activity. Write word and read word protocol is suitable for accessing registers particularly for 16-bit data ALS and 12-bit / 16-bit PS data. Interrupt can be cleared by reading data out from register: INT_Flag. All command codes should follow read word and write word protocols.

Send Byte → Write Command to VCNL4030X01

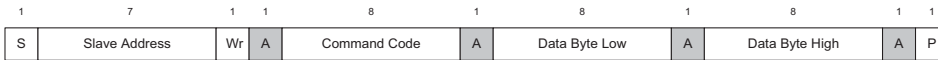

Receive Byte → Read Data from VCNL4030X01

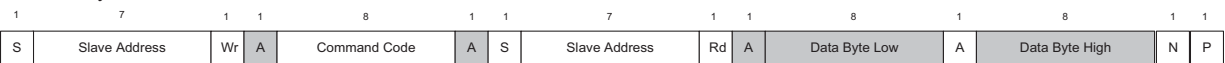

S = start condition
P = stop condition
A = acknowledge
N = no acknowledge
Shaded area = VCNL4030X01 acknowledge

Fig. 17 - Write Word and Read Word Protocol

Function Description

VCNL4030X01 applies a 16-bit high resolution ALS that provides the best ambient light sensing capability down to 0.004 lux/step which works well under a low transmittance lens design (dark lens). A flexible interrupt function of ALS (register: ALS_CONF) is also supported. The INT signal will not be asserted by VCNL4030X01 if the ALS value is not over high INT threshold window level, or lower than low INT threshold window level of ALS. As long as the ALS INT is asserted, the host can read the data from VCNL4030X01. VCNL4030X01 detects different light sources such as fluorescent light, incandescent light, sunlight, and white LED with high accuracy ALS data output after detecting algorithm is implemented.

For proximity sensor function, VCNL4030X01 supports different kinds of mechanical designs to achieve the best proximity detection performance for any color of object with more flexibility. The basic PS function settings, such as duty ratio, integration time, interrupt, and PS enable / disable, and persistence, are handled by the register: PS_CONF1. Duty ratio controls the PS response time. Integration time represents the duration of the energy being received. The interrupt is asserted when the PS detection levels over the high threshold level setting (register: PS_THDH) or lower than low threshold (register: PS_THDL). If the interrupt function is enabled, the host reads the PS output data from VCNL4030X01 that saves host loading from periodically reading PS data. More than that, INT flag (register: INT_Flag) indicates the behavior of INT triggered under different conditions. PS persistence (PS_PERS) sets up the PS INT asserted conditions as long as the PS output value continually exceeds the threshold level. The intelligent cancellation level can be set on register: PS_CANC to reduce the cross talk phenomenon.

VCNL4030X01 also supports an easy use of proximity detection logic output mode that outputs just high / low levels saving loading from the host. Normal operation mode or proximity detection logic output mode can be selected on the register: PS_MS. A smart persistence is provided to get faster PS response time and prevent false trigger for PS. Descriptions of each slave address operation are shown in table 1



TABLE 1 - COMMAND CODE AND REGISTER DESCRIPTION

COMMAND CODE	DATE BYTE LOW / HIGH	REGISTER NAME	R / W	DEFAULT VALUE	FUNCTION DESCRIPTION
0x00	L	ALS_CONF1	R / W	0x01	ALS integration time, persistence, interrupt, and function enable / disable
	H	ALS_CONF2	R / W	0x01	White channel enable / disable
0x01	L	ALS_THDH_L	R / W	0x00	ALS high interrupt threshold LSB byte
	H	ALS_THDH_M	R / W	0x00	ALS high interrupt threshold MSB byte
0x02	L	ALS_THDL_L	R / W	0x00	ALS low interrupt threshold LSB byte
	H	ALS_THDL_M	R / W	0x00	ALS low interrupt threshold MSB byte
0x03	L	PS_CONF1	R / W	0x01	PS duty ratio, integration time, persistence, and PS enable / disable
	H	PS_CONF2	R / W	0x00	PS gain, PS output resolution, PS interrupt trigger
0x04	L	PS_CONF3	R / W	0x00	PS smart persistence, active force mode
	H	PS_MS	R / W	0x00	LED current selection
0x05	L	PS_CANC_L	R / W	0x00	PS cancellation level setting
	H	PS_CANC_M	R / W	0x00	PS cancellation level setting
0x06	L	PS_THDL_L	R / W	0x00	PS low interrupt threshold setting LSB byte
	H	PS_THDL_M	R / W	0x00	PS low interrupt threshold setting MSB byte
0x07	L	PS_THDH_L	R / W	0x00	PS high interrupt threshold setting LSB byte
	H	PS_THDH_M	R / W	0x00	PS high interrupt threshold setting MSB byte
0x08	L	PS_Data_L	R	0x00	PS LSB output data
	H	PS_Data_M	R	0x00	PS MSB output data
0x09	L	Reserved	R	0x00	Reserved
	H	Reserved	R	0x00	Reserved
0x0A	L	Reserved	R	0x00	Reserved
	H	Reserved	R	0x00	Reserved
0x0B	L	ALS_Data_L	R	0x00	ALS LSB output data
	H	ALS_Data_M	R	0x00	ALS MSB output data
0x0C	L	White_Data_L	R	0x00	White LSB output data
	H	White_Data_M	R	0x00	White MSB output data
0x0D	L	Reserved	R	0x00	Reserved
	H	INT_Flag	R	0x00	ALS, PS interrupt flags, PS sunlight protection mode flag
0x0E	L	ID_L	R	0x86	Device ID LSB
	H	ID_M	R	0x01	Device ID MSB

Note

- All of reserved register are used for internal test. Please keep as default setting

Command Register Format

VCNL4030X01 provides an 8-bit command register for ALS and PS controlling independently. The description of each command format is shown in following tables.

TABLE 2 - REGISTER: ALS_CONF1 DESCRIPTION

REGISTER NAME		COMMAND CODE: 0x00_L (0x00 DATA BYTE LOW)							
Command	Bit	7	6	5	4	3	2	1	0
		COMMAND CODE: 0x00_L (0x00 DATA BYTE LOW)							
Command	Bit	Description							
ALS_IT	7 : 5	(0 : 0 : 0) = 50 ms; (0 : 0 : 1) = 100 ms; (0 : 1 : 0) = 200 ms; (0 : 1 : 1) = 400 ms; (1 : 0 : 0) to (1 : 1 : 1) = 800 ms ALS integration time setting, longer integration time has higher sensitivity							
Reserved	4	Default = (0)							
ALS_PERS	3 : 2	(0 : 0) = 1, (0 : 1) = 2, (1 : 0) = 4, (1 : 1) = 8 ALS interrupt persistence setting							
ALS_INT_EN	1	0 = ALS interrupt disable, 1 = ALS interrupt enable							
ALS_SD	0	0 = ALS power on, 1 = ALS shut down, default = 1							

**TABLE 3 - REGISTER: ALS_CONF2 DESCRIPTION**

REGISTER: ALS_CONF2		COMMAND CODE: 0x00_H (0x00 DATA BYTE HIGH)
Command	Bit	Description
Reserved	7 : 1	Default = (0 : 0 : 0 : 0 : 0 : 0 : 0)
WHITE_SD	0	0 = WHITE channel power on, 1 = WHITE channel shut down, default = 1

TABLE 4 - REGISTER ALS_THDH_L AND ALS_THDH_M DESCRIPTION

REGISTER: ALS_THDH_L AND ALS_THDH_M		COMMAND CODE: 0x01_L (0x01 DATA BYTE LOW) OR 0x01_H (0x01 DATA BYTE HIGH)
Register	Bit	Description
ALS_THDH_L	7 : 0	0x00 to 0xFF, ALS high interrupt threshold LSB byte
ALS_THDH_M	7 : 0	0x00 to 0xFF, ALS high interrupt threshold MSB byte

TABLE 5 - REGISTER: ALS_THDL_L AND ALS_THDL_M DESCRIPTION

REGISTER: ALS_THDL_L AND ALS_THDL_M		COMMAND CODE: 0x02_L (0x02 DATA BYTE LOW) AND 0x02_H (0x02 DATA BYTE HIGH)
Register	Bit	Description
ALS_THDL_L	7 : 0	0x00 to 0xFF, ALS low interrupt threshold LSB byte
ALS_THDL_M	7 : 0	0x00 to 0xFF, ALS low interrupt threshold MSB byte

TABLE 6 - REGISTER: PS_CONF1 DESCRIPTION

REGISTER: PS_CONF1		COMMAND CODE: 0x03_L (0x03 DATA BYTE LOW)
Command	Bit	Description
PS_Duty	7 : 6	(0 : 0) = 1/40, (0 : 1) = 1/80, (1 : 0) = 1/160, (1 : 1) = 1/320 PS IRED on / off duty ratio setting
PS_PERS	5 : 4	(0 : 0) = 1, (0 : 1) = 2, (1 : 0) = 3, (1 : 1) = 4 PS interrupt persistence setting
PS_IT	3 : 1	(0 : 0 : 0) = 1T, (0 : 0 : 1) = 1.5T, (0 : 1 : 0) = 2T, (0 : 1 : 1) = 2.5T, (1 : 0 : 0) = 3T, (1 : 0 : 1) = 3.5T, (1 : 1 : 0) = 4T, (1 : 1 : 1) = 8T, PS integration time setting
PS_SD	0	0 = PS power on, 1 = PS shut down, default = 1

TABLE 7 - REGISTER: PS_CONF2 DESCRIPTION

REGISTER: PS_CONF2		COMMAND CODE: 0x03_H (0x03 DATA BYTE HIGH)
Command	Bit	Description
Reserved	7 : 6	(0 : 0), reserved
PS_Gain	5 : 4	(0 : 0) and (0 : 1) = two step mode, (1 : 0) = single mode x 8, (1 : 1) = single mode x 1
PS_HD	3	0 = PS output is 12 bits, 1 = PS output is 16 bits
PS_NS	2	0 = typical sensitivity (two step mode x 4), 1 = typical sensitivity mode (two step mode)
PS_INT	1 : 0	(0 : 0) = interrupt disable, (0 : 1) = trigger by closing, (1 : 0) = trigger by away, (1 : 1) = trigger by closing and away

**TABLE 8 - REGISTER: PS_CONF3 DESCRIPTION**

REGISTER: PS_CONF3		COMMAND CODE: 0x04_L (0x04 DATA BYTE LOW)
Command	Bit	Description
LED_I_LOW	7	0 = disabled = normal current, 1 = enabled = 1/10 of normal current, with that the current is accordingly: 5 mA, 7.5 mA, 10 mA, 12 mA, 14 mA, 16 mA, 18 mA, 20 mA
Reserved	6 : 5	(0 : 0)
PS_SMART_PERS	4	0 = disable; 1 = enable PS smart persistence
PS_AF	3	0 = active force mode disable (normal mode), 1 = active force mode enable
PS_TRIG	2	0 = no PS active force mode trigger, 1 = trigger one time cycle VCNL4030X01 output one cycle data every time host writes in '1' to sensor. The state returns to '0' automatically.
PS_MS	1	0 = proximity normal operation with interrupt function, 1 = proximity detection logic output mode enable
PS_SC_EN	0	0 = turn off sunlight cancel; 1 = turn on sunlight cancel PS sunlight cancel function enable setting

TABLE 9 - REGISTER: PS_MS DESCRIPTION

REGISTER: PS_MS		COMMAND CODE: 0x04_H (0x04 DATA BYTE HIGH)
Command	Bit	Description
Reserved	7	0
PS_SC_CUR	6 : 5	(0 : 0) = 1 x typical sunlight cancel current, (0 : 1) = 2 x typical sunlight cancel current, (1 : 0) = 4 x typical sunlight cancel current, (1 : 1) = 8 x typical sunlight cancel current
PS_SP	4	0 = typical sunlight capability, 1 = 1.5 x typical sunlight capability
PS_SPO	3	0 = output is 00h in sunlight protect mode, 1 = output is FFh in sunlight protect mode,
LED_I	2 : 0	(0 : 0 : 0) = 50 mA; (0 : 0 : 1) = 75 mA; (0 : 1 : 0) = 100 mA; (0 : 1 : 1) = 120 mA (1 : 0 : 0) = 140 mA; (1 : 0 : 1) = 160 mA; (1 : 1 : 0) = 180 mA; (1 : 1 : 1) = 200 mA LED current selection setting

TABLE 10 - REGISTER PS_CANC_L AND PS_CANC_M DESCRIPTION

		COMMAND CODE: 0x05_L (0x05 DATA BYTE LOW) AND 0x05_H (0x05 DATA BYTE HIGH)
Register	Bit	Description
PS_CANC_L	7 : 0	0x00 to 0xFF, PS cancellation level setting_LSB byte
PS_CANC_M	7 : 0	0x00 to 0xFF, PS cancellation level setting_MSB byte

TABLE 11 - REGISTER: PS_THDL_L AND PS_THDL_M DESCRIPTION

		COMMAND CODE: 0x06_L (0x06 DATA BYTE LOW) AND 0x06_H (0x06 DATA BYTE HIGH)
Register	Bit	Description
PS_THDL_L	7 : 0	0x00 to 0xFF, PS interrupt low threshold setting_LSB byte
PS_THDL_M	7 : 0	0x00 to 0xFF, PS interrupt low threshold setting_MSB byte

TABLE 12 - REGISTER: PS_THDH_L AND PS_THDH_M DESCRIPTION

		COMMAND CODE: 0x07_L (0x07 DATA BYTE LOW) AND 0x07_H (0x07 DATA BYTE HIGH)
Register	Bit	Description
PS_THDH_L	7 : 0	0x00 to 0xFF, PS interrupt high threshold setting_LSB byte
PS_THDH_M	7 : 0	0x00 to 0xFF, PS interrupt high threshold setting_MSB byte

**TABLE 13 - READ OUT REGISTER DESCRIPTION**

Register	Command Code	Bit	Description
PS_Data_L	0x08_L (0x08 data byte low)	7 : 0	0x00 to 0xFF, PS1 LSB output data
PS_Data_M	0x08_H (0x08 data byte high)	7 : 0	0x00 to 0xFF, PS1 MSB output data
Reserved	0x09_L (0x09 data byte low)	7 : 0	Reserved
Reserved	0x09_H (0x09 data byte high)	7 : 0	Reserved
Reserved	0x0A_L (0x0A data byte low)	7 : 0	Reserved
Reserved	0x0A_H (0x0A data byte high)	7 : 0	Reserved
ALS_Data_L	0x0B_L (0x0B data byte low)	7 : 0	0x00 to 0xFF, ALS LSB output data
ALS_Data_M	0x0B_H (0x0B data byte high)	7 : 0	0x00 to 0xFF, ALS MSB output data
White_Data_L	0x0C_L (0x0C data byte low)	7 : 0	0x00 to 0xFF, white LSB output data
White_Data_M	0x0C_H (0x0C data byte high)	7 : 0	0x00 to 0xFF, white MSB output data
Reserved	0x0D_L (0x0D data byte low)	7 : 0	Default = 0x00
INT_Flag	0x0D_H (0x0D data byte high)	7 6 5 4 3 2 1 0	Reserved Reserved ALS_IF_L, ALS crossing low THD INT trigger event ALS_IF_H, ALS crossing high THD INT trigger event Reserved PS_SPFLAG, PS entering sunlight protection mode PS_IF_CLOSE, PS rises above PS_THDH INT trigger event PS_IF_AWAY, PS drops below PS_THDL INT trigger event
ID_L	0x0E_L (0x0E data byte low)	7 : 0	86H for MP version sample, device ID LSB byte
ID_M	0x0E_H (0x0E data byte high)	7 : 6 5 : 4 3 : 0	(0 : 0) (0:0) = slave address = 0x60 (7-bit) (0:1) = slave address = 0x51 (7-bit) (1:0) = slave address = 0x40 (7-bit) (1:1) = slave address = 0x41 (7-bit) Version code (0 : 0 : 0 : 0), device ID MSB byte

Adjustable Sampling Time

VCNL4030X01's embedded LED driver drives the internal IRED with the "LDR" pin by a pulsed duty cycle. The IRED on / off duty ratio is programmable by I²C command at register: PS_Duty which is related to the current consumption and PS response time. The higher the duty ratio adopted, the faster response time achieved with higher power consumption. For example, PS_Duty = 1/320, peak IRED current = 100 mA, averaged current consumption is 100 mA/320 = 0.3125 mA.

Initialization

VCNL4030X01 includes default values for each register. As long as power is on, it is ready to be controlled by host via I²C bus.



Threshold Window Setting

- ALS Threshold Window Setting (Applying ALS INT)

Register: ALS_THDH_L and ALS_THDH_M defines 16-bit ALS high threshold data for LSB byte and MSB byte. Register: ALS_THDL_L and ALS_THDL_M defines 16-bit ALS low threshold data for LSB byte and MSB byte. As long as ALS INT function is enabled, INT will be asserted once the ALS data exceeds ALS_THDH or goes below ALS_THDL. To easily define the threshold range, multiply the value of the resolution (lux/step) by the threshold level (refer to table 14).

TABLE 14 - ALS RESOLUTION AND MAXIMUM DETECTION RANGE			
ALS_IT		SENSITIVITY	MAXIMUM DETECTION RANGE
ALS_IT (7 : 5)	INTEGRATION TIME (typ.)	UNIT (lx/step)	UNIT (lx)
(0, 0, 0)	50 ms	0.064	4192
(0, 0, 1)	100 ms	0.032	2096
(0, 1, 0)	200 ms	0.016	1048
(1, 0, 0)	400 ms	0.008	524
(1, 0, 1) to (1, 1, 1)	800 ms	0.004	262

- ALS Persistence
The ALS INT is asserted as long as the ALS value is higher or lower than the threshold window when ALS_PERS (1, 2, 4, 8 times) is set to one time. If ALS_PERS is set to four times, then the ALS INT will not be asserted if the ALS value is not over (or lower) than the threshold window for four continued refresh times (integration time).
- Programmable PS Threshold
VCNL4030X01 provides both high and low thresholds for PS (register: PS_THDL, PS_THDH).
- PS Persistence
The PS persistence function (PS_PERS, 1, 2, 3, 4) helps to avoid false trigger of the PS INT. For example, if PS_PERS = 3 times, the PS INT will not be asserted unless the PS value is greater than the PS threshold (PS_THDH) value for three periods of time continuously.
- PS Active Force mode
An extreme power saving way to use PS is to apply PS active force (register: PS_CONF3 command: PS_FOR = 1) mode. Anytime host would like to read out just one of PS data, write in '1' at register: PS_CONF3 command: PS_FOR_Trig. Without commands placed, there is no PS data output. VCNL4030X01 stays in standby mode constantly.
- PS detection object
Any color of object is detectable by VCNL4030X01.

Data Access

All of VCNL4030X01 command registers are readable. To access 16-bit high resolution ALS output data, it is suitable to use read word protocol to read out data by just one command at register: ALS_DataL and ALS_DataM. To represent the 16-bit data of ALS, it has to apply two bytes. One byte is for LSB, and the other byte is for MSB as shown in table 18. In terms of reading out 8-bit PS data, it is also very convenient to read PS at register: PS_Data.

TABLE 15 - 16-BIT ALS DATA FORMAT																
VCNL4030X01																
Bit	15	14	13	12	11	10	9	8	7	6	5	4	3	2	1	0
Register	ALS_DataM							ALS_DataL								

Intelligent Cancellation

VCNL4030X01 provides an intelligent cancellation method to reduce cross talk phenomenon for the proximity sensor. The output data will be subtracted by the input value on register: PS_CANC.

Interruption (INT)

VCNL4030X01 has ALS and PS interrupt feature operated by a single pin "INT". The purpose of the interrupt feature is to actively inform the host once INT has been asserted. With the interrupt function applied, the host does not need to be constantly pulling data from the sensor, but to read data from the sensor while receiving interrupt request from the sensor. As long as the host enables ALS interrupt (register: ALS_INT_EN) or PS interrupt (register: PS_INT) function, the level of INT pin (pin 7) is pulled low once INT asserted. All registers are accessible even if INT is asserted.

ALS INT asserted when ALS value cross over the value set by register: ALS_THDH or lower than the value set by register: ALS_THDL. To effectively adopt PS INT function, it is recommended to use PS detection mechanism at register: PS_INTT = 1 for the best PS detection performance which can be adjusted by high / low THD level of PS. PS INT trigger way is defined by register: PS_INT.

Interruption Flag

Register: INT_Flag represents all of interrupt trigger status for ALS and PS. Any flag value changes from '0' to '1' state, the level of INT pin will be pulled low. As long as host reads INT_Flag data, the bit will change from '1' state to '0' state after reading out, the INT level will be returned to high afterwards.

PROXIMITY DETECTION LOGIC OUTPUT MODE

VCNL4030X01 provides a proximity detection logic output mode that uses INT pin (pin 7) as a proximity detection logic high / low output (register: PS_MS). When this mode is selected, the PS output (pin 7; INT/P_{out}) is pulled low when an object is closing to be detected and returned to level high when the object moves away. Register: PS_THDH / PS_THDL defines how sensitive PS detection is.

One thing to be stated is that whenever proximity detection logic mode applied, INT pin is only used as a logic high / low output. If host would like to use ALS with INT function, register: PS_MS has to be selected to normal operation mode (PS_MS = 0). Meanwhile, host has to simulate the GPIO pin as an INT pin function. If not, host needs to periodically reading the state of INT at this GPIO pin.

PROXIMITY DETECTION HYSTERESIS

A PS detection hysteresis is important that keeps PS state in a certain range of detection distance. For example, PS INT asserts when PS value over PS_THDH. Host switches off panel backlight and then clears INT. When PS value is less than PS_THDL, host switches on panel backlight. Any PS value lower than PS_THDH or higher than PS_THDL, PS INT will not be asserted. Host does keep the same state.

APPLICATION CIRCUIT BLOCK REFERENCE

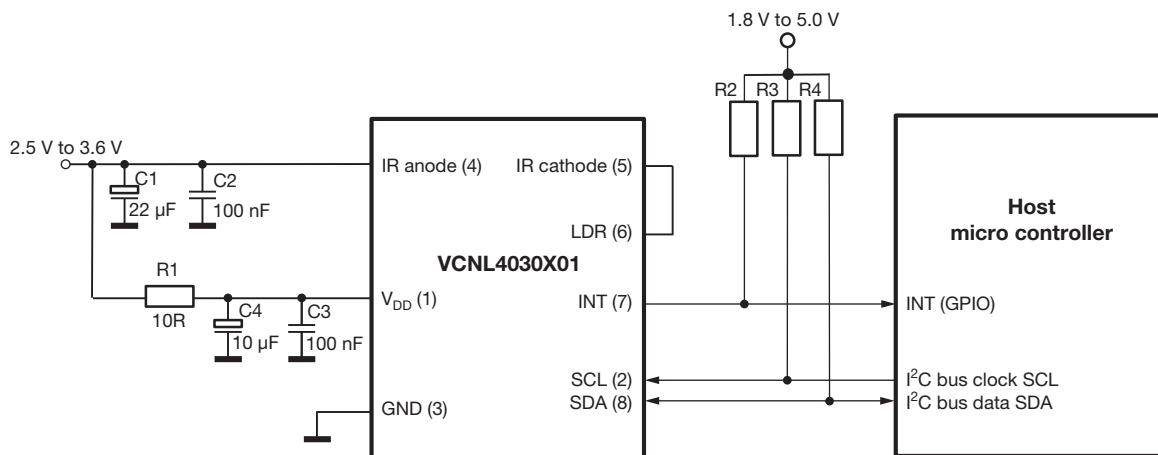
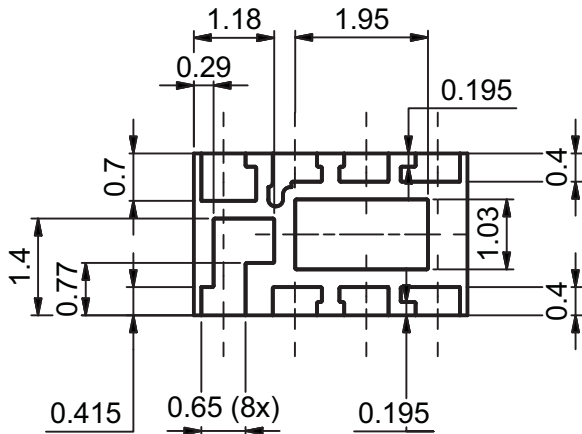

Fig. 18 - Circuitry with Just One Common Power Supply Source



PACKAGE DIMENSIONS in millimeters



Pinning Bottom View

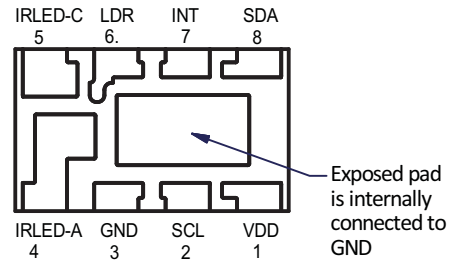

Pinning Top View

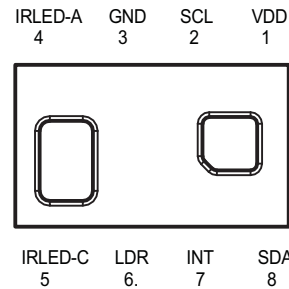

Recommended solder foot print

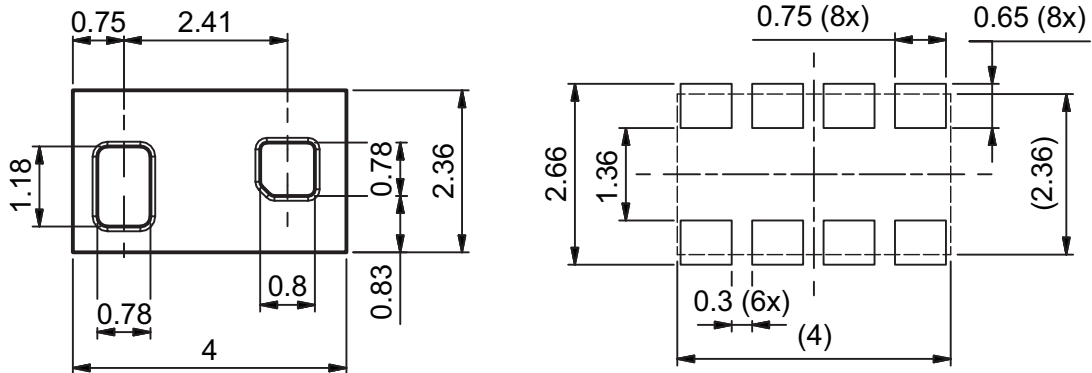

Drawing No.: 6.550-5326.01-4
Issue: 1, 21.07.2017

Not indicated tolerances ± 0.1 mm

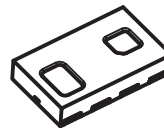

Technical drawings according to DIN specification.



TAPE AND REEL DIMENSIONS in millimeters

Reel-Size:
GS 08: \varnothing 180 mm \pm 2 mm = 3300 pcs.
GS 18: \varnothing 330 mm \pm 2 mm = 13 000 pcs.
Reel-design is representative for different types

Non tolerated dimensions \pm 0.1 mm

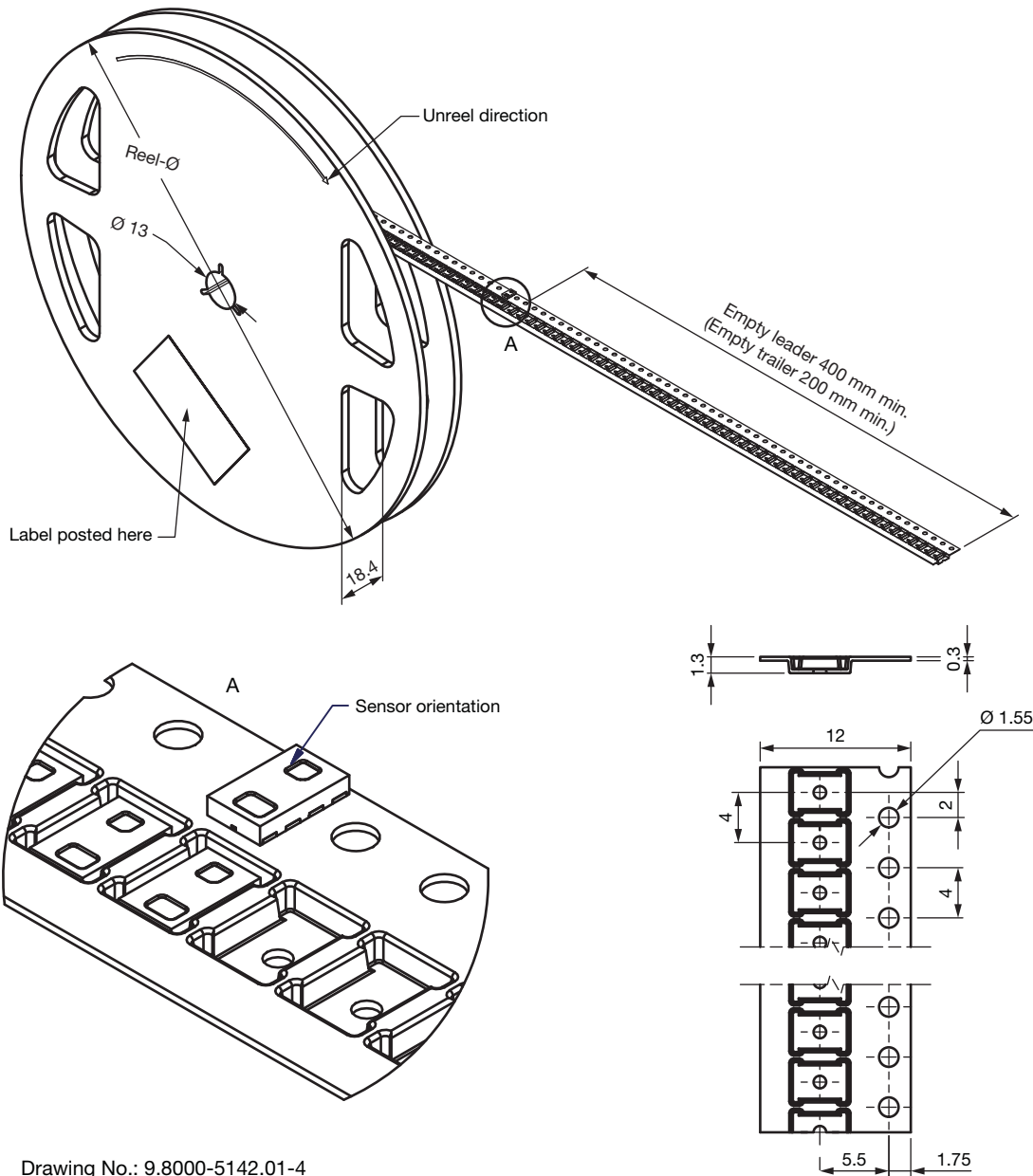

Drawing No.: 9.8000-5142.01-4
Issue: 1, 07.06.2017



SOLDER PROFILE

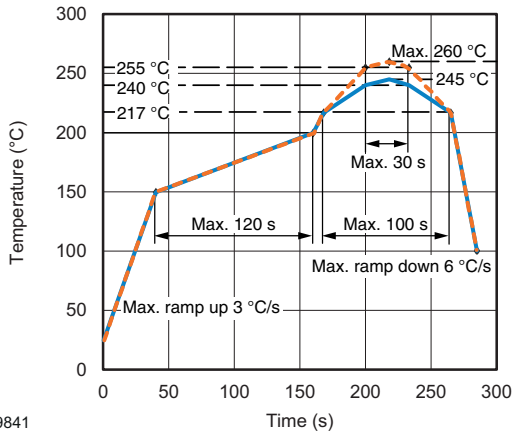

Fig. 19 - Lead (Pb)-free Reflow Solder Profile According to J-STD-020

DRYPACK

Devices are packed in moisture barrier bags (MBB) to prevent the products from moisture absorption during transportation and storage. Each bag contains a desiccant.

FLOOR LIFE

Floor life (time between soldering and removing from MBB) must not exceed the time indicated on MBB label:

Floor life: 168 h

Conditions: $T_{amb} < 30\text{ °C}$, $RH < 60\%$

Moisture sensitivity level 3, according to J-STD-020.

DRYING

In case of moisture absorption devices should be baked before soldering. Conditions see J-STD-020 or label. Devices taped on reel dry using recommended conditions 192 h at 40 °C (+ 5 °C), $RH < 5\%$.



Disclaimer

ALL PRODUCT, PRODUCT SPECIFICATIONS AND DATA ARE SUBJECT TO CHANGE WITHOUT NOTICE TO IMPROVE RELIABILITY, FUNCTION OR DESIGN OR OTHERWISE.

Vishay Intertechnology, Inc., its affiliates, agents, and employees, and all persons acting on its or their behalf (collectively, "Vishay"), disclaim any and all liability for any errors, inaccuracies or incompleteness contained in any datasheet or in any other disclosure relating to any product.

Vishay makes no warranty, representation or guarantee regarding the suitability of the products for any particular purpose or the continuing production of any product. To the maximum extent permitted by applicable law, Vishay disclaims (i) any and all liability arising out of the application or use of any product, (ii) any and all liability, including without limitation special, consequential or incidental damages, and (iii) any and all implied warranties, including warranties of fitness for particular purpose, non-infringement and merchantability.

Statements regarding the suitability of products for certain types of applications are based on Vishay's knowledge of typical requirements that are often placed on Vishay products in generic applications. Such statements are not binding statements about the suitability of products for a particular application. It is the customer's responsibility to validate that a particular product with the properties described in the product specification is suitable for use in a particular application. Parameters provided in datasheets and / or specifications may vary in different applications and performance may vary over time. All operating parameters, including typical parameters, must be validated for each customer application by the customer's technical experts. Product specifications do not expand or otherwise modify Vishay's terms and conditions of purchase, including but not limited to the warranty expressed therein.

Except as expressly indicated in writing, Vishay products are not designed for use in medical, life-saving, or life-sustaining applications or for any other application in which the failure of the Vishay product could result in personal injury or death. Customers using or selling Vishay products not expressly indicated for use in such applications do so at their own risk. Please contact authorized Vishay personnel to obtain written terms and conditions regarding products designed for such applications.

No license, express or implied, by estoppel or otherwise, to any intellectual property rights is granted by this document or by any conduct of Vishay. Product names and markings noted herein may be trademarks of their respective owners.



Компания «ЭлектроПласт» предлагает заключение долгосрочных отношений при поставках импортных электронных компонентов на взаимовыгодных условиях!

Наши преимущества:

- Оперативные поставки широкого спектра электронных компонентов отечественного и импортного производства напрямую от производителей и с крупнейших мировых складов;
- Поставка более 17-ти миллионов наименований электронных компонентов;
- Поставка сложных, дефицитных, либо снятых с производства позиций;
- Оперативные сроки поставки под заказ (от 5 рабочих дней);
- Экспресс доставка в любую точку России;
- Техническая поддержка проекта, помощь в подборе аналогов, поставка прототипов;
- Система менеджмента качества сертифицирована по Международному стандарту ISO 9001;
- Лицензия ФСБ на осуществление работ с использованием сведений, составляющих государственную тайну;
- Поставка специализированных компонентов (Xilinx, Altera, Analog Devices, Intersil, Interpoint, Microsemi, Aeroflex, Peregrine, Syfer, Eurofarad, Texas Instrument, Miteq, Cobham, E2V, MA-COM, Hittite, Mini-Circuits, General Dynamics и др.);

Помимо этого, одним из направлений компании «ЭлектроПласт» является направление «Источники питания». Мы предлагаем Вам помощь Конструкторского отдела:

- Подбор оптимального решения, техническое обоснование при выборе компонента;
- Подбор аналогов;
- Консультации по применению компонента;
- Поставка образцов и прототипов;
- Техническая поддержка проекта;
- Защита от снятия компонента с производства.



Как с нами связаться

Телефон: 8 (812) 309 58 32 (многоканальный)

Факс: 8 (812) 320-02-42

Электронная почта: org@eplast1.ru

Адрес: 198099, г. Санкт-Петербург, ул. Калинина, дом 2, корпус 4, литера А.