

## DESCRIPTION

The MP4700 is a high-efficiency step-down converter designed to drive high-brightness light emitting diodes.

The MP4700 drives an external MOSFET in boundary conduction mode, which features no reverse recovery loss in the freewheeling diode and soft turn-on with zero-current and valley voltage for the power MOSFET that improves efficiency and minimizes the inductor value and size. The boundary conduction control mode regulates the LED current by sensing the MOSFET peak current through an external resistor. Its low 300mV feedback voltage reduces power loss and improves efficiency.

The MP4700 implements PWM dimming to the LED current.

Protection features include output short protection, under-voltage lockout for the IC input voltage and bus input voltage, a limited maximum switching frequency, and thermal shut down.

## FEATURES

- 8V-to-18V Input Voltage
- Constant-Current LED Driver
- Power MOSFET Zero-Current Turn-On
- No Freewheeling Diode Reverse Recovery Issues
- High Efficiency and Reliability in Boundary Conduction Mode
- Low 1mA Operation Current
- PWM Dimming Control
- Hiccup Short Circuit Protection
- UVLO for Bus Input Voltage
- Input UVLO, Thermal Shutdown
- Maximum Frequency Limited to 160kHz
- Available in SOIC8 Package

## APPLICATIONS

- LED Backlighting for TV and Monitor
- DC/DC or AC/DC LED Driver applications
- General Illumination
- Industrial Lighting
- Automotive/ Decorative LED Lighting

All MPS parts are lead-free and adhere to the RoHS directive. For MPS green status, please visit MPS website under Quality Assurance. "MPS" and "The Future of Analog IC Technology" are Registered Trademarks of Monolithic Power Systems, Inc.

## TYPICAL APPLICATION

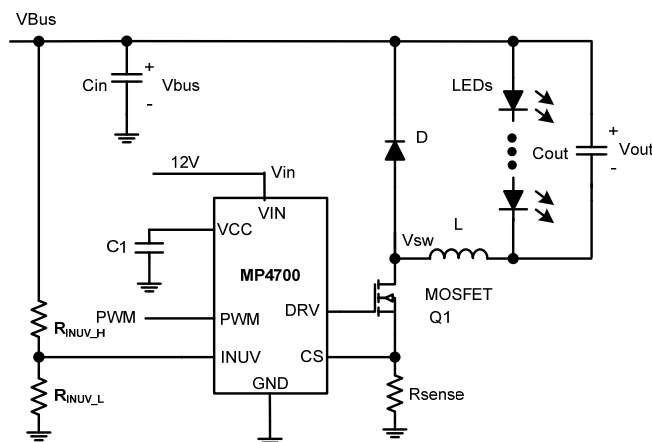

**ORDERING INFORMATION**

Part Number*	Package	Top Marking
MP4700GS	SOIC8	MP4700

\*For Tape & Reel, add suffix -Z (eg. MP4700GS-Z)

**PACKAGE REFERENCE**

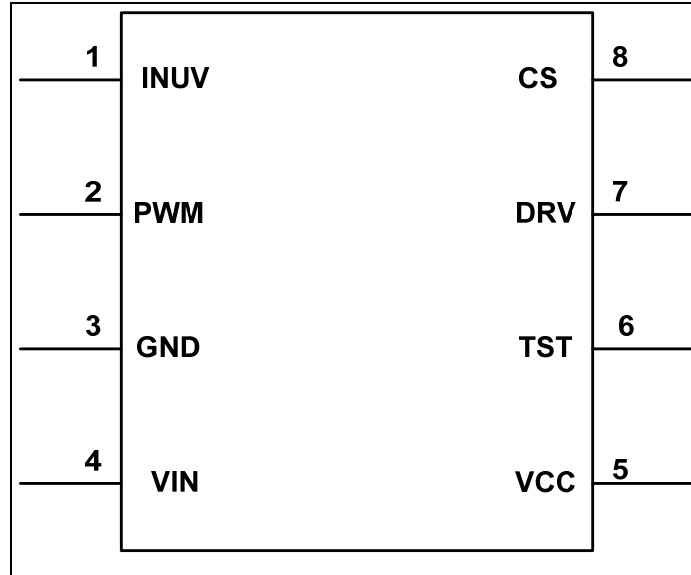

**ABSOLUTE MAXIMUM RATINGS <sup>(1)</sup>**

VIN	-0.3V to 20V
VCC, DRV	-0.3V to 11V
PWM, INUV, CS	-0.3V to 6.5V
Continuous Power Dissipation	(T <sub>A</sub> =25°C) <sup>(2)</sup>
SOIC8	1.3W
Junction Temperature	150°C
Lead Temperature	260°C
Storage Temperature	-55°C to +150°C

**Recommended Operating Conditions <sup>(3)</sup>**

VIN	8V to 18V
VCC, DRV	-0.3V to 10.5V
Operating Junct. Temp(T <sub>J</sub> )	-40°C to +125°C

**Thermal Resistance <sup>(4)</sup>**

	<b>θ<sub>JA</sub></b>	<b>θ<sub>JC</sub></b>
SOIC8	96	45 ... °C/W

**Notes:**

- Exceeding these ratings may damage the device.
- The maximum allowable power dissipation is a function of the maximum junction temperature T<sub>J</sub> (MAX), the junction-to-ambient thermal resistance θ<sub>JA</sub>, and the ambient temperature T<sub>A</sub>. The maximum allowable continuous power dissipation at any ambient temperature is calculated by P<sub>D</sub> (MAX) = (T<sub>J</sub> (MAX) - T<sub>A</sub>) / θ<sub>JA</sub>. Exceeding the maximum allowable power dissipation will cause excessive die temperature, and the regulator will go into thermal shutdown. Internal thermal shutdown circuitry protects the device from permanent damage.
- The device is not guaranteed to function outside of its operating conditions.
- Measured on JESD51-7, 4-layer PCB.

## ELECTRICAL CHARACTERISTICS

$V_{IN} = 12VDC$ ,  $V_{PWM} = 5V$ , no load on pin DRV,  $T_A = +25^{\circ}C$ , unless otherwise noted.

Parameters	Symbol	Condition	Min	Typ	Max	Units
Input Voltage	$V_{IN}$	DC voltage at Pin VIN	8		18	V
Input Supply Current (Quiescent)	$I_{INQS}$	$V_{PWM} = 0V$		0.6		mA
Input Supply Current (Operation)	$I_{INRUN}$	$V_{PWM} = 5V$		0.78		mA
VCC Voltage	VCC	$V_{IN} = 10V$ ( $V_{IN} < 12V$ )	7.5	8.5	9.5	V
VCC peak voltage	$V_{CCH}$	$V_{IN} = 18V$ ( $V_{IN} > 12V$ )		9.8		V
VCC valley voltage	$V_{CCL}$	$V_{IN} = 18V$ ( $V_{IN} > 12V$ )		9		V
VCC UVLO	$V_{CCUVLO}$	$V_{IN}$ rising with a DC input	7	7.4	7.8	V
VCC UVLO Hysteresis	$V_{CCHys}$	$V_{IN}$ falling with a DC input		1		V
PWM Input High Threshold	$V_{PWMH}$	$V_{PWM}$ rising			1.5	V
PWM Input Low Threshold	$V_{PWML}$	$V_{PWM}$ falling	0.75			V
PWM Pull-Up Current	$I_{PVM Pull UP}$	$V_{PWM} = 0V$		10.6		uA
Bus Input Voltage UVLO Threshold	$V_{INUV\_th\_rising}$	Bus input voltage rising	1.15	1.2	1.25	V
Bus Input Voltage UVLO Hysteresis	$V_{INUV\_hys}$	Bus input voltage falling	50	86	120	mV
PWM Dimming ON Propagation Delay	$T_{PVMon\_PD}$	PWM rising edge to Drive rising edge		1.3	2	us
PWM Dimming OFF Propagation Delay	$T_{PVMoff\_PD}$	PWM falling edge to Drive falling edge		230	350	ns
CS Pin Reference Voltage	$V_{REF}$	$-40^{\circ}C \leq T_A \leq +85^{\circ}C$	270	302	330	mV
CS Pin Reference Voltage	$V_{REF}$	$T_A = +25^{\circ}C$	285	302	315	mV
Leading Edge Blanking Time	$T_{LEB}$		200	320	450	ns
CS Bias Current	$I_{CS}$	$V_{CS} = 0.3V$	-0.5		0	$\mu A$
Gate Drive Source Current	$I_{DRV Source}$	$V_{DRV} = 0V$		550		mA
Gate Drive Sink Current	$I_{DRV Sink}$	$V_{DRV} = V_{CC}$		-1.2		A
Drive Low Level Output Voltage	$V_{DRVL}$	$I_{DRV} = 10mA$		54		mV
Drive High Level Output Voltage to Rail	$V_{DRVH}$	$I_{DRV} = -10mA$		122		mV
Gate Minimal Turn-On Time	$T_{ON\_Min}$			320	450	ns
Max Switching Frequency	$f_{SW Max}$			160		kHz
Over-Temperature Protection Threshold	$T_{OTP}$			150		$^{\circ}C$
Over-Temperature Protection Threshold Hysteresis	$T_{OTP\_Hys}$			30		$^{\circ}C$
Output Short Shut Down Time	$T_{shut-down}$			2.8		ms

## PIN FUNCTIONS

Pin #	Name	Description
1	INUV	Input Bus Voltage UVLO. Sense with a voltage divider.
2	PWM	PWM Dimming Input. Connect directly to the PWM dimming signal. Apply a high voltage or leave open for no applied dimming control.
3	GND	Ground.
4	VIN	Input Supply. Apply a voltage in the range of 8V to 18V.
5	VCC	Internal Regulated Supply Voltage Output. Must be locally bypassed. Provides power for IC logic and to drive the external MOSFET.
6	TST	Test. Connect to GND.
7	DRV	External MOSFET Drive Signal. Also detects the zero current crossing.
8	CS	LED Current Sense Input. Connect to the current sense resistor that programs the LED current.

**TYPICAL CHARACTERISTICS**

**PWM Pull Up Current vs. Temperature**

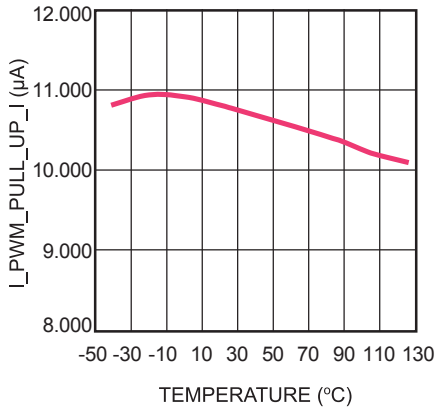

**CS Pin Current vs. Temperature**  
V<sub>CS</sub>=0.3V

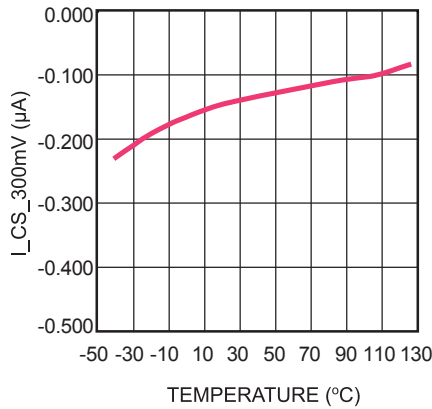

**Input Bus Voltage UVLO Threshold vs. Temperature**

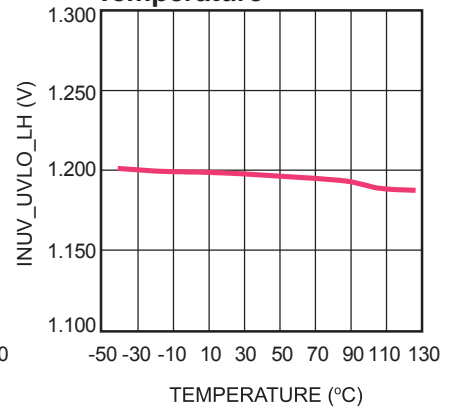

**Input Bus Voltage UVLO Hysteresis vs. Temperature**

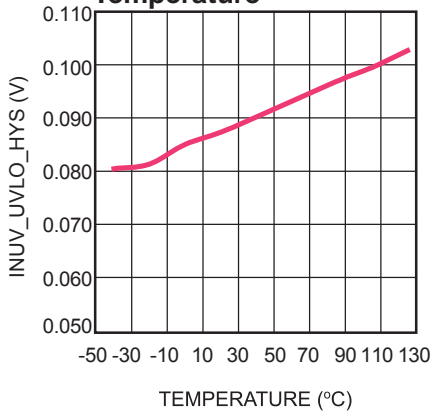

**VCC UVLO vs. Temperature**

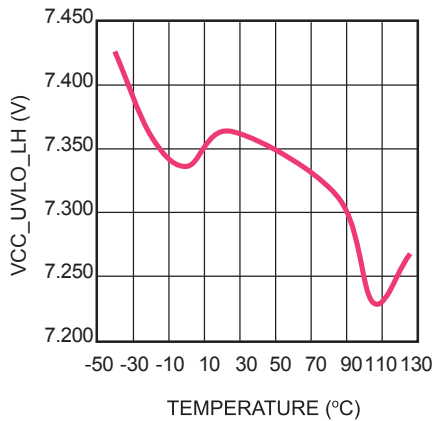

**VCC Voltage vs. Temperature**  
V<sub>IN</sub>=10V

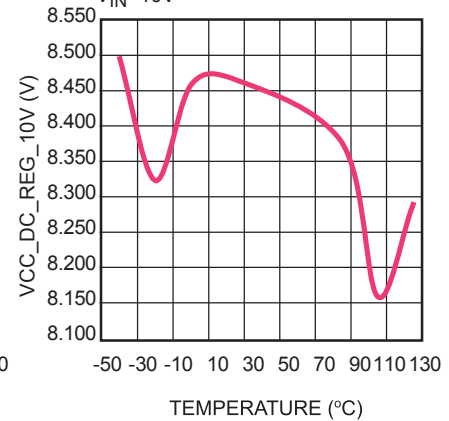

**PWM Input High Threshold vs. Temperature**

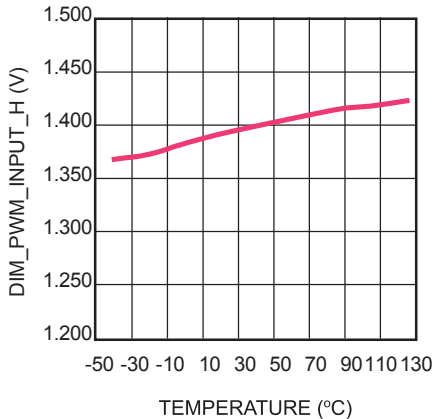

**PWM Low High Threshold vs. Temperature**

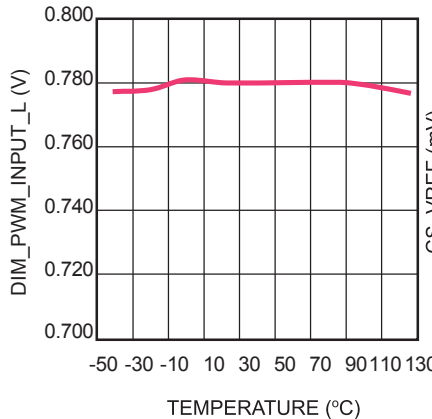

**CS Reference Voltage vs. Temperature**

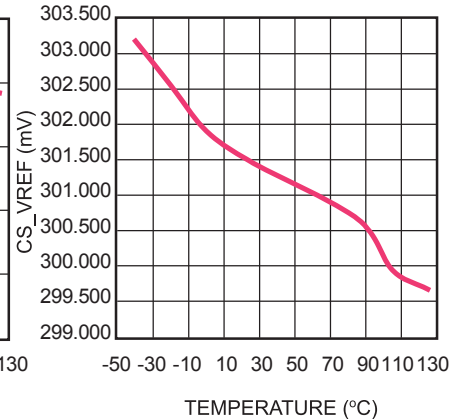

**TYPICAL CHARACTERISTICS** *(continued)*

**PWM Dimming On Propagation Delay Time vs. Temperature**



**PWM Dimming Off Propagation Delay Time vs. Temperature**



**Leading Edge Blanking Time vs. Temperature**



**Maximum Off Time vs. Temperature**

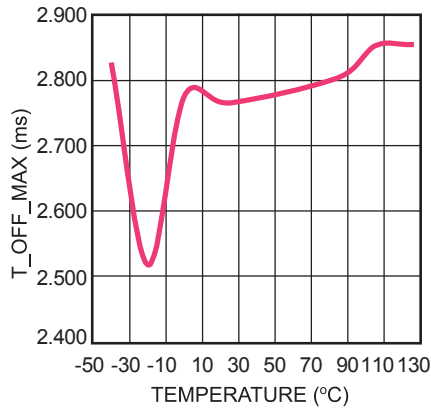

### TYPICAL PERFORMANCE CHARACTERISTICS

$V_{IN} = 12.5VDC$ ,  $V_{PWM} = 5V$ ,  $V_{BUS} = 220V$ ,  $V_{LED} = 180V$ ,  $I_{LED} = 0.22A$ ,  $T_A = +25^\circ C$ , unless otherwise noted.

**LED Current vs. Input Bus Voltage**

$V_{LED} = 180V$ ,  $I_{LED} = 0.22A$

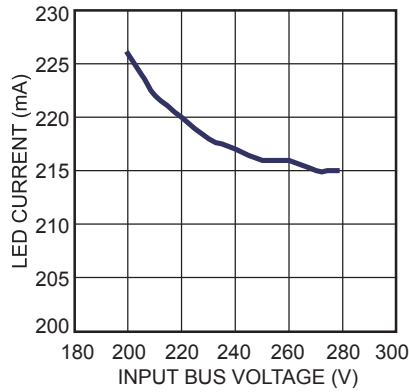

**Efficiency vs. Input Bus Voltage**

$V_{LED} = 198V$ ,  $I_{LED} = 0.22A$

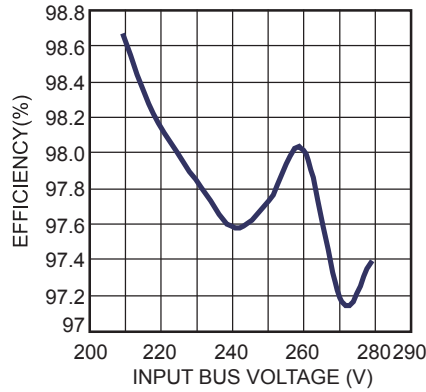

**LED Current vs. PWM Dimming Duty**

$V_{BUS} = 220V$ ,  $V_{LED} = 180V$ ,  $I_{LED} = 0.22A$ ,  $f_{PWM} = 200Hz$

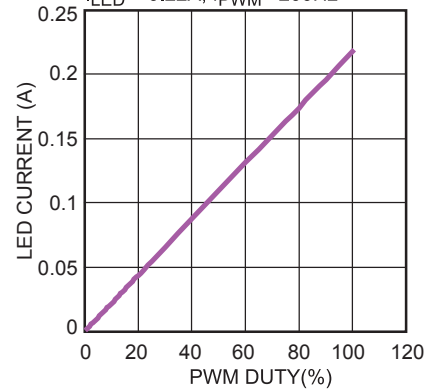

**LED Current vs. PWM Dimming Duty**

PWM Duty < 1%

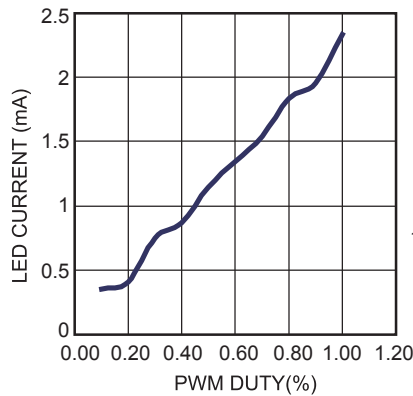

**IC  $V_{IN}$  Turn On**

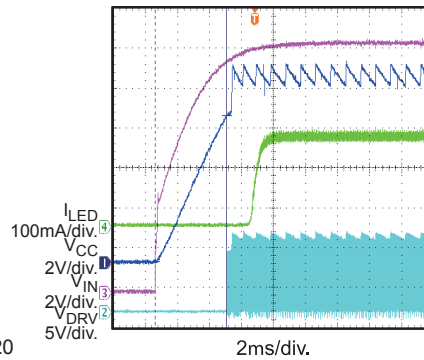

**IC  $V_{IN}$  Turn Off**

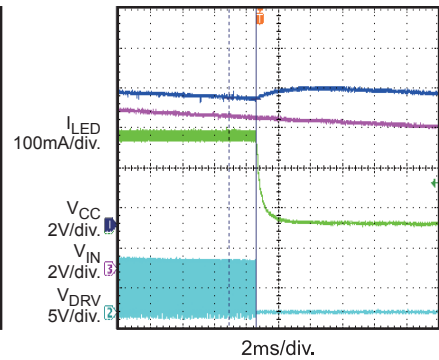

**PWM Turn On**

$V_{IN} = 12.5V$

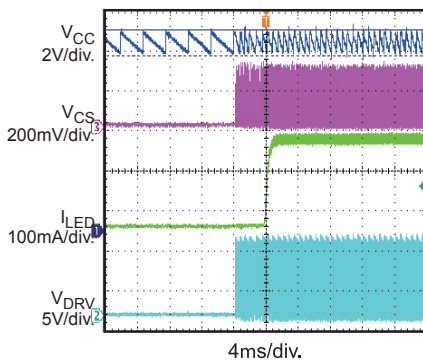

**PWM Turn Off**

$V_{IN} = 10.7V$

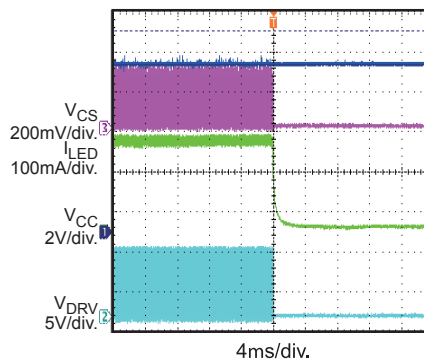

**$V_{BUS}$  Turn On**

$V_{IN} = 12.5V$

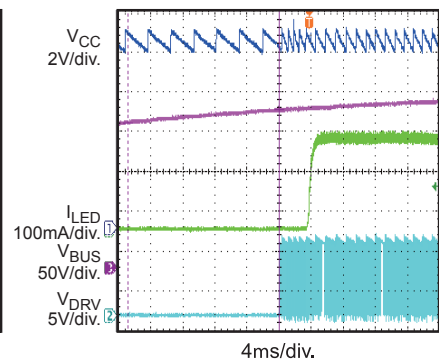

**TYPICAL PERFORMANCE CHARACTERISTICS (continued)**

$V_{IN} = 12.5VDC$ ,  $V_{PWM} = 5V$ ,  $V_{BUS} = 220V$ ,  $V_{LED} = 180V$ ,  $I_{LED} = 0.22A$ ,  $T_A = +25^\circ C$ , unless otherwise noted.

**$V_{BUS}$  Turn Off**  
 $V_{IN} = 12.5V$



**PWM Dimming**  
 $f_{PWM} = 480Hz$ , 95%



**PWM Dimming**  
 $f_{PWM} = 480Hz$ , 10%



**PWM Dimming**  
 $f_{PWM} = 480Hz$ , 1%

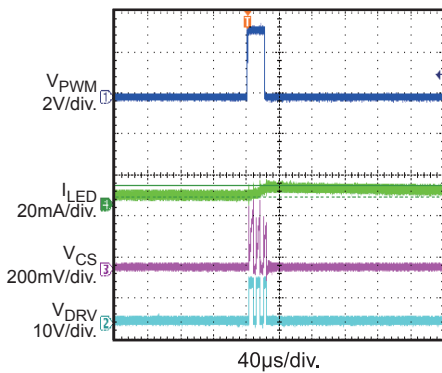

**Short Protection and Recovery**

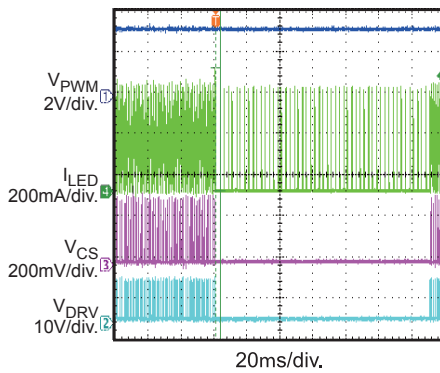



**FUNCTIONAL BLOCK DIAGRAM**

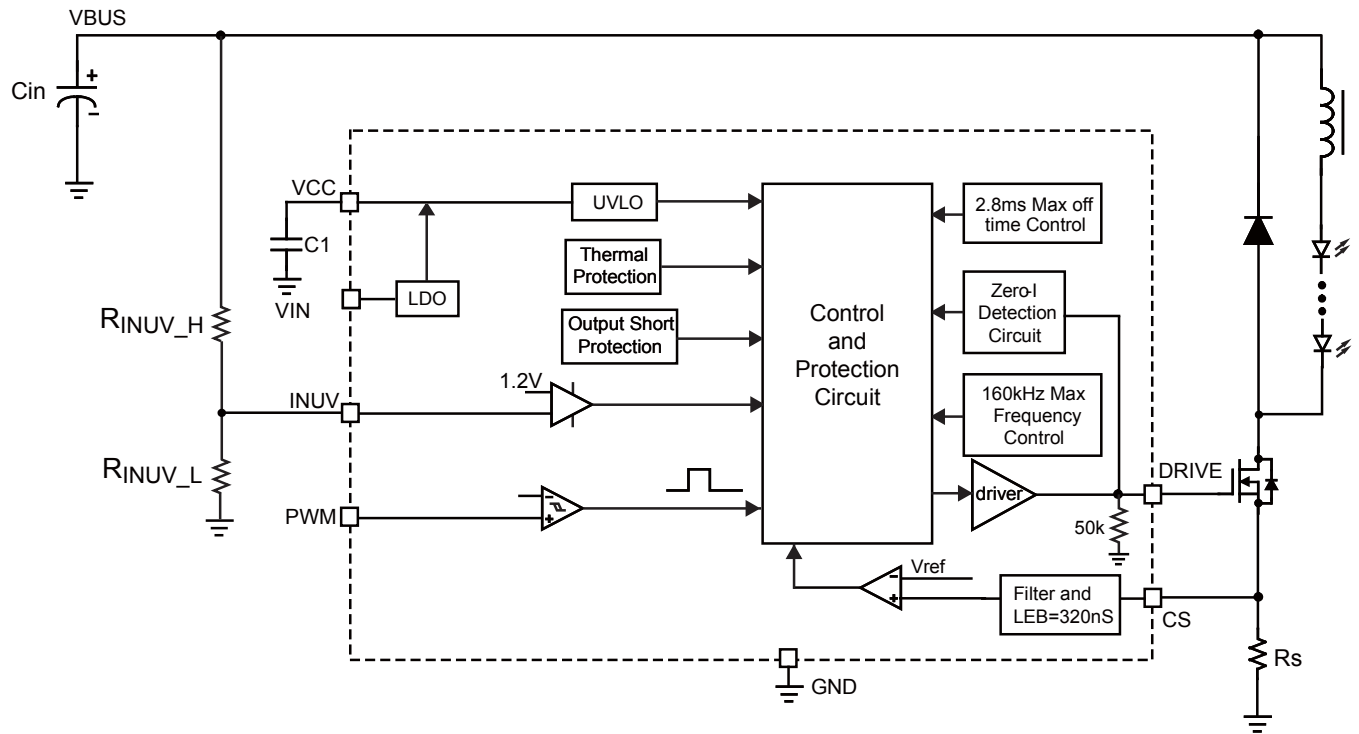

Figure 1: Block Diagram

## OPERATION

### Internal Regulator

The MP4700 uses a low dropout (LDO) regulator to supply the IC. Use a DC voltage in the range of 8V to 18V to power the IC.

The internal LDO regulator maintains the VCC voltage at 8.4V when the input voltage is less than 12V. The VCC pin requires a ceramic bypass capacitor.

When the input voltage exceeds 12V, the LDO regulator switches to switch-controlled current source mode. The VCC voltage charges to its peak voltage (9.8V) and then the current source stops. After the VCC voltage decreases to its valley voltage (9V), the current source turns on again. This switch-controlled current source mode reduces the LDO power consumption and improves efficiency.

### LED Current Regulation and Valley Detection

In floating-buck-converter configuration, as shown in the typical application circuit, the MP4700 controls the MOSFET (Q1) using peak current control. The CS pin senses the peak current through a resistor ( $R_{sense}$ ) to regulate the current to:

$$I_{L\_PEAK} = \frac{302mV}{R_{sense}}$$

In normal operation, the MP4700 turns on Q1 when the current in the freewheeling diode goes to zero. As a result, the average LED current is:

$$I_{LED} = \frac{302mV}{2R_{sense}}$$

The zero-current detection is realized at the DRV pin by sensing the MOSFET drain  $dv/dt$  current through the Q1's miller capacitor. When the current through the freewheeling diode goes to zero, the Q1 drain voltage ( $V_{SW}$ ) drops from  $V_{BUS}$  to  $(V_{BUS} - V_{OUT})$  and oscillates thanks to the inductor and the parasitic capacitors. When  $V_{SW}$  drops to the minimum value, the  $dv/dt$  current through the miller capacitor rises from negative to zero. At this point, the MP4700 turns on Q1 as the inductor current goes to zero and the Q1 drain voltage is at its minimum.

The MP4700 controls the buck converter in current-boundary-conduction mode.

To improve zero current detection, add a 10pF capacitor between the Q1 drain and source .

Add a capacitor ( $C_{out}$ ) in parallel to the LED string to reduce the current ripple.

Boundary operation mode minimizes the Q1 turn-on loss and eliminates the freewheeling diode's reverse recovery loss to reduce passive components' size requirements at high switching frequencies. Furthermore, the required inductance value is already small, further reducing the inductor size.

### Brightness Dimming Control

The MP4700 employs PWM dimming to control the LED current. Use a 100Hz-to-2kHz PWM signal. PWM input high triggers IC switching. PWM input low turns off the IC.

For applications that do not need PWM dimming control, apply a high voltage on the PWM pin or leave the PWM pin open.

### Frequency Setting and Inductor Design

In case the zero-current detection circuit fails—which can happen at start-up during an output short condition with a large output capacitor—applying a maximum off time of about 2.8ms ensures that the MP4700 continues to operate and the prevents short current runaway.

The MP4700 has a maximum switching frequency of 160kHz to avoid extreme circuit losses and ensure better EMI performance. If the converter reaches the maximum frequency, it will operate in discontinuous current conduction mode. Avoid this operation mode since the LED current is out of regulation.

Inductor design is critical to to ensure that the switching frequency ( $f_s$ ) is within the 30kHz to 160kHz range.

$$L = \frac{1}{f_s \cdot 2 \cdot I_{LED}} \cdot \frac{(V_{BUS} - V_{out}) \cdot V_{out}}{V_{BUS}}$$

Where  $V_{BUS}$  is the input voltage of the Buck converter, and  $V_{out}$  is the LED voltage.

### Hiccup Output-Short Protection

If the entire LED string is shorted,  $V_{OUT}$  is zero. Due to the minimal on time limit, the inductor current will be out of regulation. The MP4700 can detect this failure and shut down for about 2.8ms, and then re-tries the operation. This hiccup protection can eliminate thermal issues due to a short-circuit current, and also maintain normal operation if the protection is mis-triggered.

### Input-Bus-Voltage Under-Voltage Lockout (UVLO) Protection

The MP4700 implements UVLO protection for the input bus voltage. The INUV pin senses the input bus voltage through a voltage divider. The IC is locked out until the input bus voltage rises so that the INUV voltage pin exceeds its UVLO threshold. This UVLO function protects against a low input bus voltage. For best results, set the input bus voltage UVLO point over 1.1 times the output LED voltage.

Set the input bus UVLO as follows:

$$\frac{R_{INUV\_H}}{R_{INUV\_L}} = \frac{V_{Bus\ UVLO}}{V_{INUV\_th}} - 1$$

Where  $V_{INUV\_th}=1.2V$  is the INUV pin threshold voltage.

### VCC Under-Voltage Lockout (UVLO) Protection

Under-voltage lockout (UVLO) protects the chip from operating at an insufficient supply voltage. The UVLO rising threshold is about 7.4V while its falling threshold is a consistent 6.4V.

### Thermal Shutdown Protection

An accurate temperature protection prevents the chip from operating at exceedingly high temperatures. When the silicon die temperature exceeds its upper threshold, it shuts down the whole chip. When the temperature drops below its lower threshold, the chip is enabled again.

## DESIGN EXAMPLE

### TV LED Backlighting

The design example introduces an MP4700-based high-performance TV LED backlighting solution. Figure 2 shows the structure of this total system solution—Flyback+MP4700 low-side buck for single-string TV LED backlight. The flyback converts the AC input line voltage

to the system output supply voltage 13V/2A, and also outputs a DC bus voltage (around 280V) to the LED driver. The flyback is based on the MPS quasi-resonant flyback controller, HFC0100. The MP4700 acts as the LED driver stage as a boundary conduction mode (BCM) low-side buck.

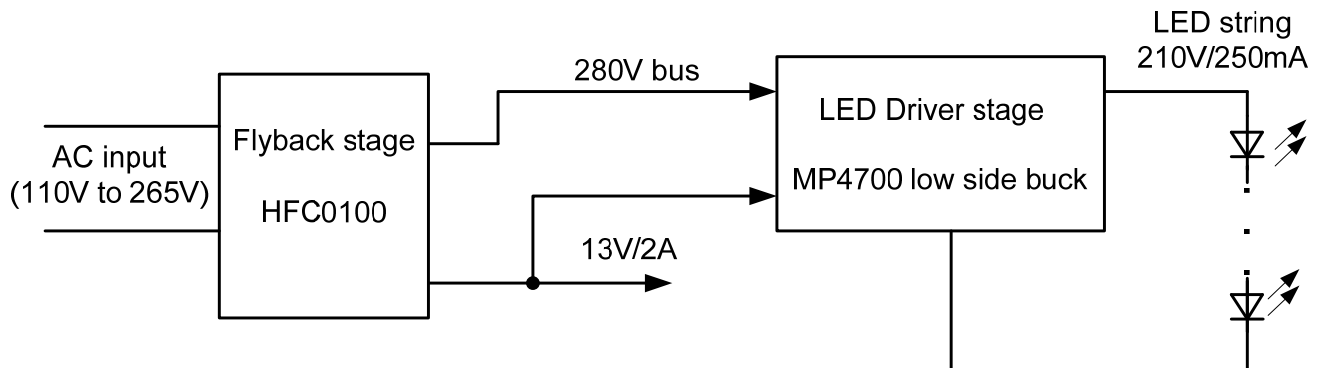

Figure 2: Power System Structure

### Specifications:

Description	Parameter	Units
Input voltage	110 to 265	VAC
Input frequency	50	Hz
Output DC Bus voltage	13.4	V
Output DC Bus current	2	A
LED Voltage	210	V
LED Current	250	mA

Protection: short LED protection, open LED protection and 13V over-voltage protection.

### Schematics:

Figure 3 and Figure 4 show the schematics of the HFC0100 flyback stage and the MP4700 LED driver stage. The parameters of the power transformer T2 are as follow:

Turn ratio:

$$N_p:N_{bus1}:N_{bus2}:N_{13V}:N_{Au}=45:51:51:5:10$$

Primary inductance:  $L_p=360\mu\text{H}$ .

In this application example, the bus voltage uses 2 windings. Each winding outputs half of the bus voltage (140V) after the rectifier, dividing the voltage stress across each rectifier diode. The reduced stress allows for the use of 800V diodes.

Both the 13V voltage and the 280V bus voltage feed back to the flyback control circuit, which decreases the influence of the cross regulation.

The 13V system voltage also supplies the MP4700.

The following describes the design of the MP4700 LED driver. The design procedure for the HFC0100 flyback is not described here, but rather in the HFC0100 design materials.

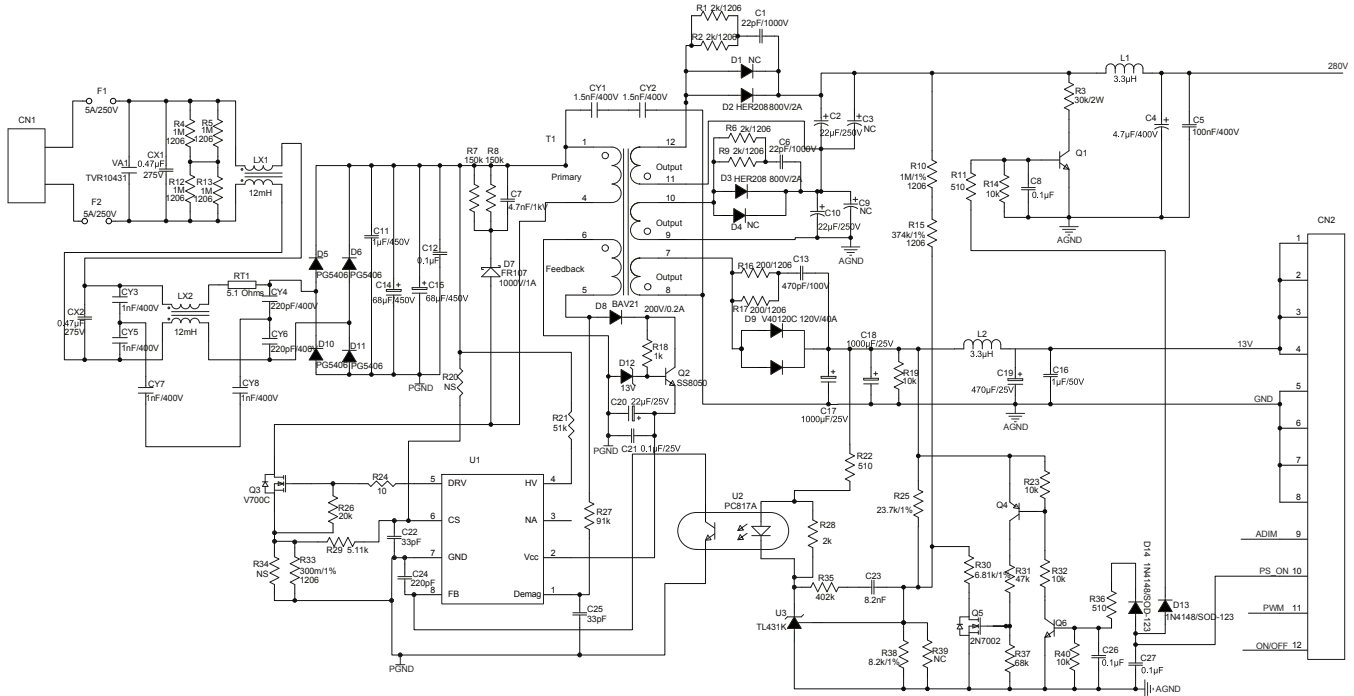

**Figure 3: HFC0100 Flyback Schematic**

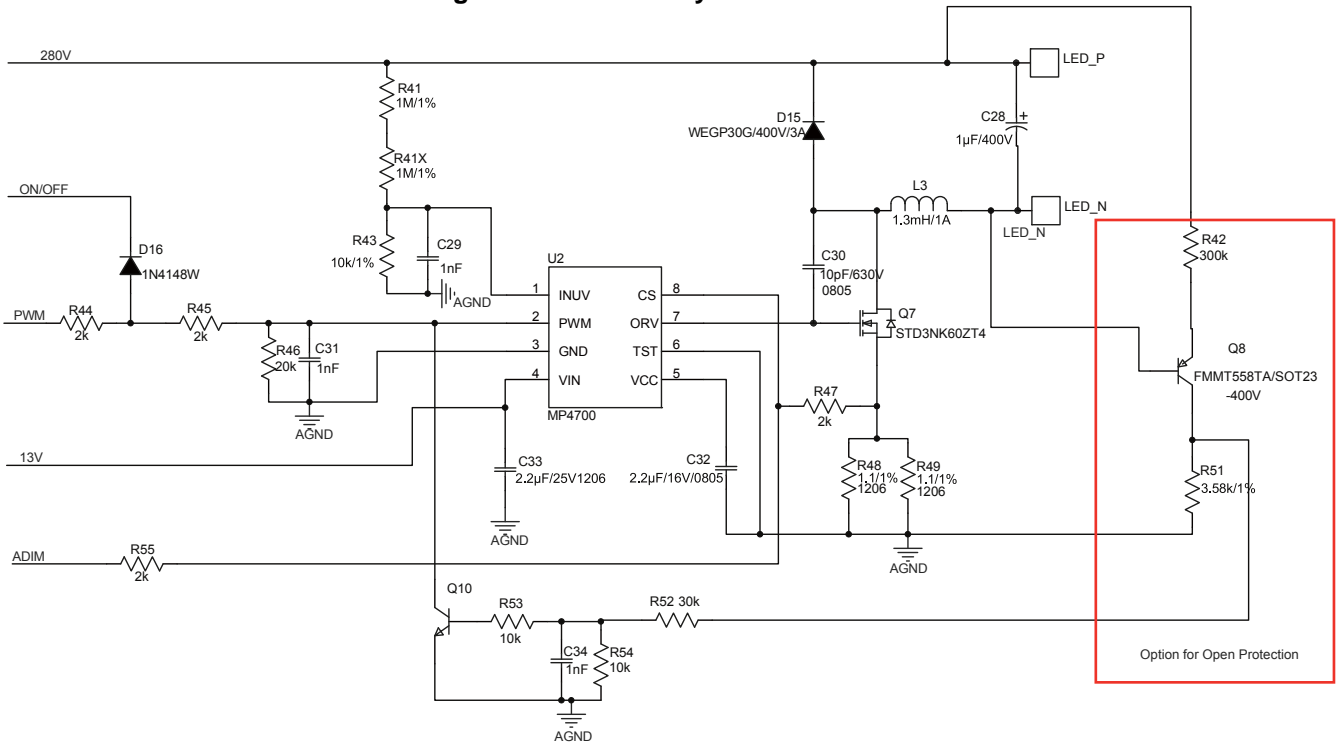

**Figure 4: MP4700 Low-Side Buck LED Driver Schematic**

**Select the Inductor**

The MP4700 operates at BCM. Select a proper inductor to ensure that the operating frequency is within a desired range.

Assuming the 280V bus voltage has -10% to +20% variation, and the LED voltage has a ±10% variation. The maximum system operating frequency at the maximum input bus voltage and the minimum output LED voltage should not exceed the MP4700’s 160kHz frequency limit.

$$L \geq \frac{1}{f_{s\_max} \cdot 2 \cdot I_{LED}} \cdot \frac{(V_{Bus\_max} - V_{LED\_min}) \cdot V_{LED\_min}}{V_{Bus\_max}}$$

Choosing a maximum operating frequency at 150kHz, the inductor should exceed 1.1mH. The peak inductor current is around 2 times the LED current when the MP4700 operates in BCM. An inductor rated at 1.3mH/0.6A would fit this application.

**Select the Power MOSFET**

The voltage stress of the power MOSFET should exceed the bus voltage. A MOSFET with 400V voltage rating will suffice for this application. The peak current through the MOSFET equals the peak inductor current, or 2 times the LED current (250mA). The maximum RMS current through the MOSFET is:

$$I_{RMS\_MOS\_max} = 2I_{LED} * \sqrt{\frac{V_{LED\_max}}{3V_{bus\_min}}} = 0.27A$$

Choose a MOSFET with a current rating around 2A to 3A.

**Select the Diode**

The voltage stress of the diode should exceed the bus voltage—400V will suffice for this application. The maximum average current through the diode is:

$$I_{Avg\_Diode\_max} = 2I_{LED} * (1 - \frac{V_{LED\_min}}{V_{bus\_max}}) = 0.21A$$

This allows for a current rating within 1A to 2A.

**Select the Current Sense Resistor**

The MP4700 operates in BCM and the current sense resistor is:

$$R_{sense} = \frac{302mV}{2 \cdot I_{LED}} = 600m\Omega$$

**Select the Output Capacitor**

The output capacitor should be large enough to filter the output ripple current and limit the LED current ripple to within a desired range (usually below ±5%).

Use the equivalent dynamic resistance of the LED string to design the output capacitor. Figure 5 defines of the equivalent dynamic resistance of the LED string ( $R_{LED}$ ).

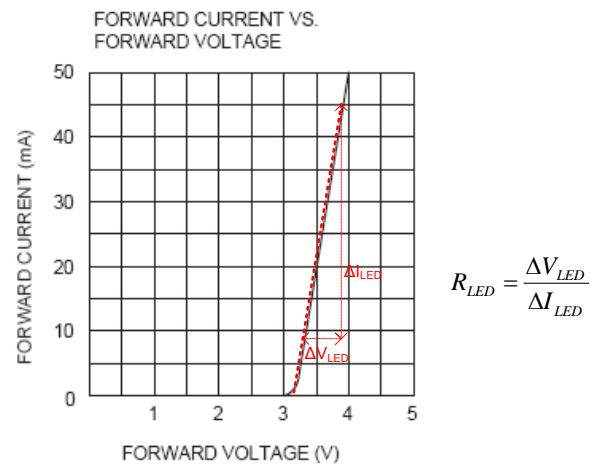

**Figure 5: LED Equivalent Dynamic Resistance**

Calculate the value of the ceramic output capacitor as:

$$C_{OUT} \geq \frac{I_{L\_PEAK}}{8f_{s\_min} \cdot R_{LED} \cdot I_{LED\_ripple\_pk\_pk}}$$

Where  $f_{s\_min}$  is the minimum operating frequency, which occurs at the minimum input voltage and maximum output voltage condition for this application.

$$f_{s\_min} = \frac{(V_{bus\_min} - V_{LED\_max}) * V_{LED\_max}}{L * I_{L\_PEAK} * V_{bus\_min}}$$

Considering that  $I_{L\_PEAK}=2 \times I_{LED}$ , the output capacitor value is:

$$C_{OUT} \geq \frac{L * I_{LED}^2 * V_{bus\_min}}{2(V_{bus\_min} - V_{LED\_max}) * V_{LED\_max} * R_{LED} * I_{LED\_ripple\_pk\_pk}}$$

If using an electrolytic output capacitor, its ESR dominates its impedance. The ESR value should be:

$$R_{ESR\_COUT} < \frac{R_{LED} * I_{LED\_ripple\_pk\_pk}}{I_{L\_PEAK}}$$

Usually, a 1µF to 2.2µF ceramic capacitor or a 10µF to 22µF electrolytic capacitor should suffice for this LED current level.

### Select the Input Capacitor

Select the input capacitor to ensure that the input voltage ripple is within a desired range (1% to 5% of the input bus voltage). The input capacitor is usually electrolytic and its ESR dominates its impedance. The ESR of this input capacitor should be:

$$R_{ESR\_Cin} < \frac{V_{bus\_ripple\_PK\_PK}}{I_{L\_PEAK}}$$

A 4.7µF to 22µF electrolytic capacitor will usually suffice.

### PCB Layout Guide

For best results, follow these layout guidelines for the MP4700 low-side buck:

- (1) Make the high-frequency switching loop (the input capacitor, the diode, the power MOSFET and the current sense resistor) as small and tight as possible.
- (2) Place the current sense resistor close to the IC and make the current sense loop as small as possible.
- (3) Separate the GND of MP4700 from the power ground of system, which conducts current of power stage.

Figure 6 and Figure 7 show an example of the PCB layout. Figure 7 shows the high-frequency switching loop (composed of the input capacitor, the diode, the power MOSFET and the current sense resistor) marked in red. Make sure to minimize this high-frequency switching loop.



Figure 6: Top Layer

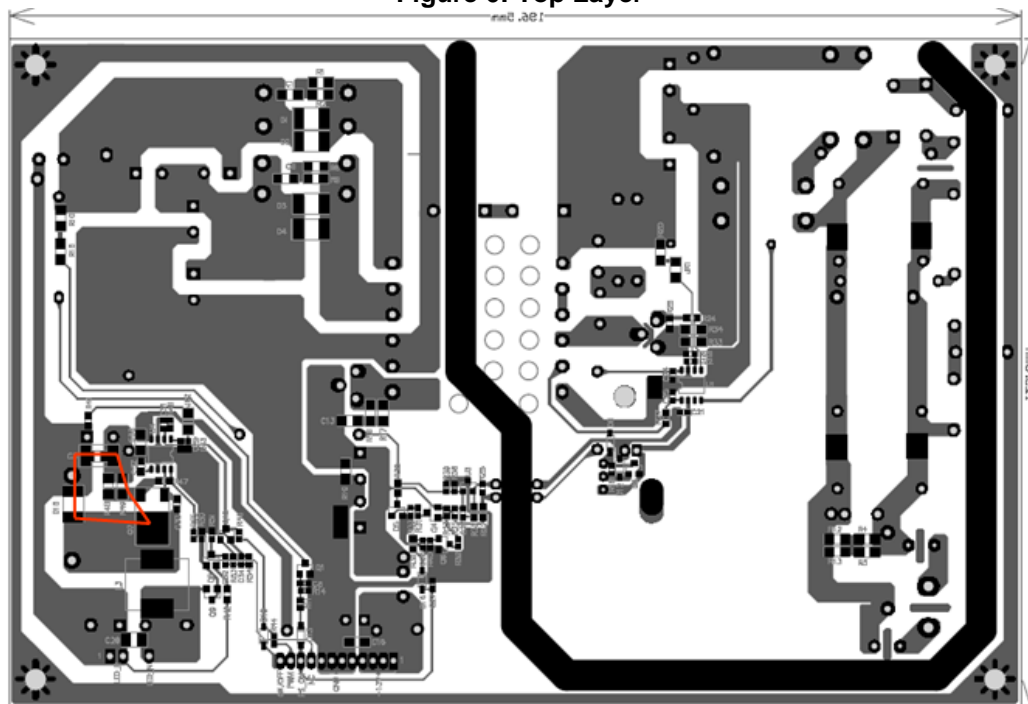
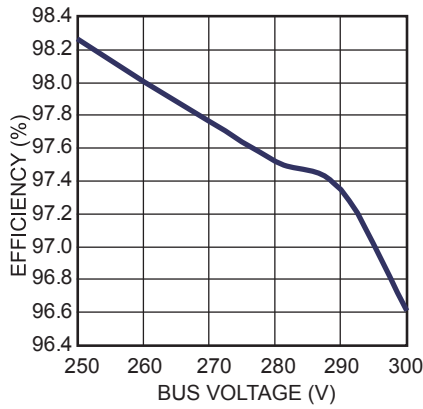

Figure 7: Bottom Layer



**System Performance**

**LED Driver Stage Efficiency**



**System Efficiency**

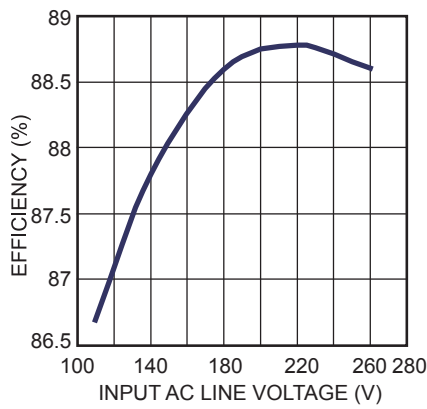

**PWM Dimming Linearity @ 200Hz**

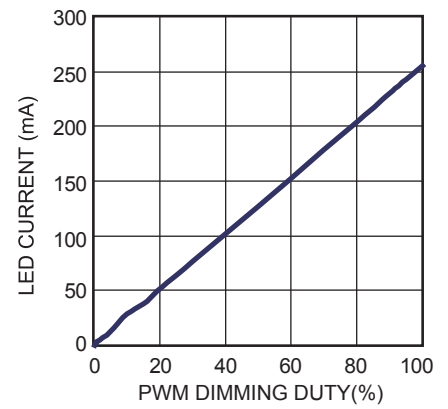

**PWM Dimming Linearity @ 2kHz**

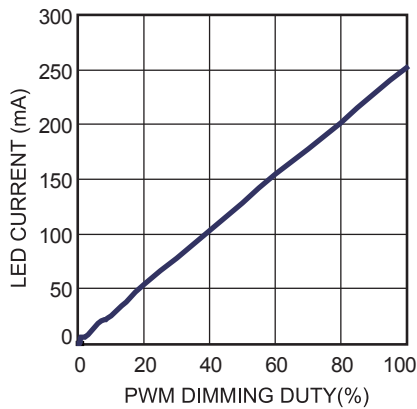

**Analog Dimming Curve**

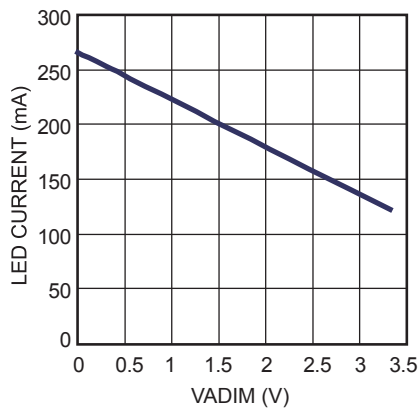

**Steady State**

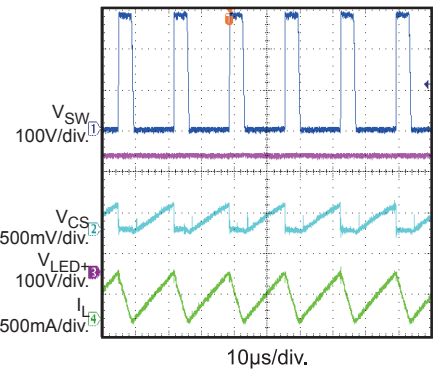

**Startup**

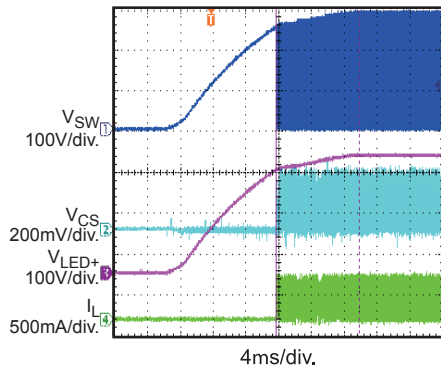

**PWM Dimming @320Hz, 50%**

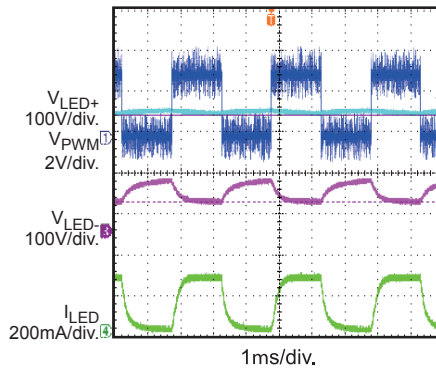

**Analog Dimming**

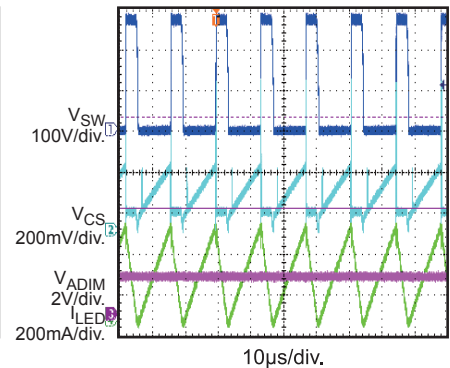

**Short LED String Protection**



**Open LED Protection**



**Open LED Protection Recover**



**PACKAGE INFORMATION**

**SOIC8**

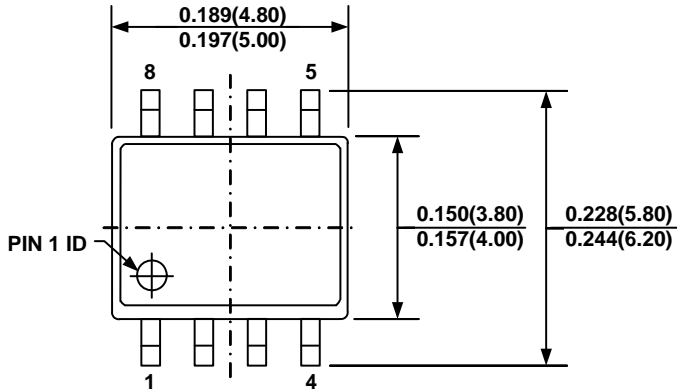

**TOP VIEW**

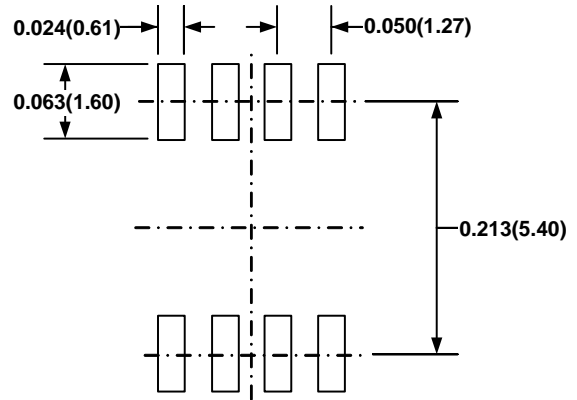

**RECOMMENDED LAND PATTERN**

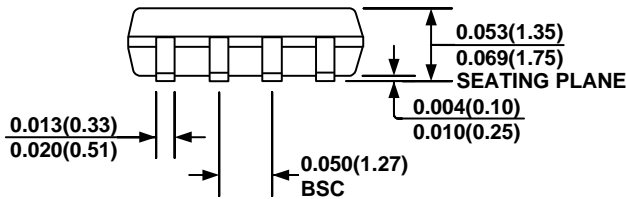

**FRONT VIEW**

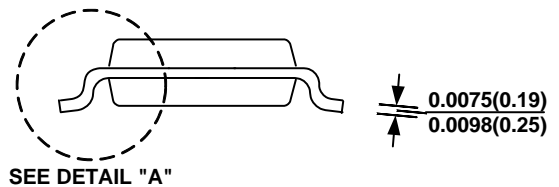

**SIDE VIEW**

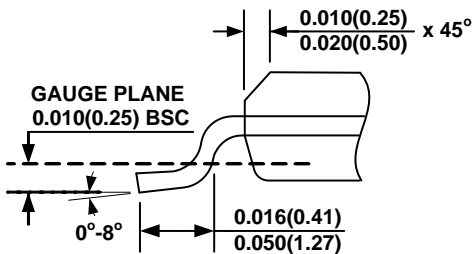

**DETAIL "A"**

**NOTE:**

- 1) CONTROL DIMENSION IS IN INCHES. DIMENSION IN BRACKET IS IN MILLIMETERS.
- 2) PACKAGE LENGTH DOES NOT INCLUDE MOLD FLASH, PROTRUSIONS OR GATE BURRS.
- 3) PACKAGE WIDTH DOES NOT INCLUDE INTERLEAD FLASH OR PROTRUSIONS.
- 4) LEAD COPLANARITY (BOTTOM OF LEADS AFTER FORMING) SHALL BE 0.004" INCHES MAX.
- 5) DRAWING CONFORMS TO JEDEC MS-012, VARIATION AA.
- 6) DRAWING IS NOT TO SCALE.

**NOTICE:** The information in this document is subject to change without notice. Users should warrant and guarantee that third party Intellectual Property rights are not infringed upon when integrating MPS products into any application. MPS will not assume any legal responsibility for any said applications.



Компания «ЭлектроПласт» предлагает заключение долгосрочных отношений при поставках импортных электронных компонентов на взаимовыгодных условиях!

Наши преимущества:

- Оперативные поставки широкого спектра электронных компонентов отечественного и импортного производства напрямую от производителей и с крупнейших мировых складов;
- Поставка более 17-ти миллионов наименований электронных компонентов;
- Поставка сложных, дефицитных, либо снятых с производства позиций;
- Оперативные сроки поставки под заказ (от 5 рабочих дней);
- Экспресс доставка в любую точку России;
- Техническая поддержка проекта, помощь в подборе аналогов, поставка прототипов;
- Система менеджмента качества сертифицирована по Международному стандарту ISO 9001;
- Лицензия ФСБ на осуществление работ с использованием сведений, составляющих государственную тайну;
- Поставка специализированных компонентов (Xilinx, Altera, Analog Devices, Intersil, Interpoint, Microsemi, Aeroflex, Peregrine, Syfer, Eurofarad, Texas Instrument, Miteq, Cobham, E2V, MA-COM, Hittite, Mini-Circuits, General Dynamics и др.);

Помимо этого, одним из направлений компании «ЭлектроПласт» является направление «Источники питания». Мы предлагаем Вам помощь Конструкторского отдела:

- Подбор оптимального решения, техническое обоснование при выборе компонента;
- Подбор аналогов;
- Консультации по применению компонента;
- Поставка образцов и прототипов;
- Техническая поддержка проекта;
- Защита от снятия компонента с производства.



#### Как с нами связаться

**Телефон:** 8 (812) 309 58 32 (многоканальный)

**Факс:** 8 (812) 320-02-42

**Электронная почта:** [org@eplast1.ru](mailto:org@eplast1.ru)

**Адрес:** 198099, г. Санкт-Петербург, ул. Калинина, дом 2, корпус 4, литера А.