

SERIES 400 SWITCHES

ROCKER SWITCHES - SUB-MINIATURE

TACT SWITCHES

NAVIGATION SWITCHES

PUSHBUTTON SWITCHES

TOGGLE SWITCHES

ROCKER SWITCHES

SLIDE SWITCHES

SNAP-ACTION SWITCHES

DIP SWITCHES

KEYLOCK SWITCHES

ROTARY SWITCHES

DETECTOR SWITCHES

CAP OPTIONS



FEATURES & BENEFITS

- ▶ Variety of switching functions
- ▶ Sub-miniature
- ▶ Multiple actuator options

APPLICATIONS/MARKETS

- ▶ Telecommunications
- ▶ Instrumentation
- ▶ Test equipment
- ▶ Networking
- ▶ Computer peripherals

SPECIFICATIONS

| | |
|------------------------|--|
| Contact Rating: | See contact material options |
| Life Expectancy: | 30,000 make-and-break cycles at full load |
| Contact Resistance: | 20 mΩ max. typical initial @ 2-4 VDC 100 mA for silver and gold plated contacts |
| Insulation Resistance: | 1,000 MΩ min |
| Dielectric Strength: | 1,000 V RMS @ sea level |
| Operating Temperature: | -30° C to 85° C |

MATERIALS

| | |
|--------------------------|--|
| Case: | Diallyl phthalate (DAP) or glass filled nylon, flame retardant, heat stabilized (UL 94-V0) |
| Rocker: | Nylon |
| Bushing: | Brass, nickel plated |
| Housing: | Stainless steel |
| Terminal/Switch Support: | Brass, or steel tin plated |
| Contacts / Terminals: | Silver or gold plated copper alloy |

HOW TO ORDER

| SERIES | MODEL NO. | ACTUATOR | ACTUATOR COLOR | TERMINATION | CONTACT MATERIAL | SEAL |
|--------|---|-------------|-------------------------------------|---|------------------------|--------------------------------------|
| 400 | □ □ □ □ □ | □ □ | □ □ □ | □ □ □ □ | □ | E |
| | MSP1 MSP2 MSP3 MSP4 MSP5 MSP6*** | R1* R6** | BLK =Black WHT=White RED =Red | M1 M2 M6 M61 M7 M71 VS2 VS21 | Q = Silver R = Gold | E = Epoxy Sealed at Base of Terminal |

Example Ordering Number

400-MSP1-R6-BLK-M6-R-E

* Std. all models except SPDT with M6 + M61 terminations.

** Std. on SPDT models with M6 + M61 terminations.

*** Not available with M6 terminations.

Specifications subject to change without notice.

SPDT

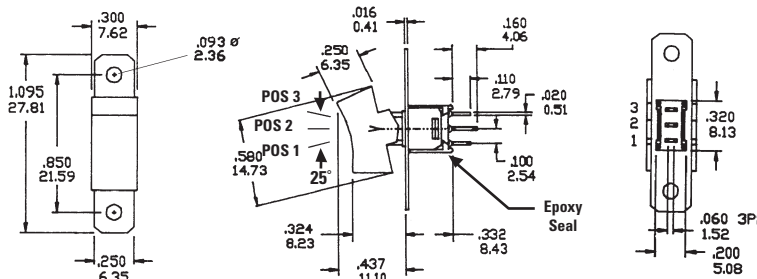

SCHEMATIC

| Model No. | POS 1 | POS 2 | POS 3 |
|-------------|-------|-------|-------|
| MSP-1 | ON | NONE | ON |
| MSP-2 | ON | NONE | (ON) |
| MSP-3 | ON | OFF | ON |
| MSP-4 | (ON) | OFF | (ON) |
| MSP-5 | ON | OFF | (ON) |
| MSP-6 | OFF | NONE | ON |
| Term. Comm. | 2-3 | OPEN | 2-1 |

() = Momentary



DPDT

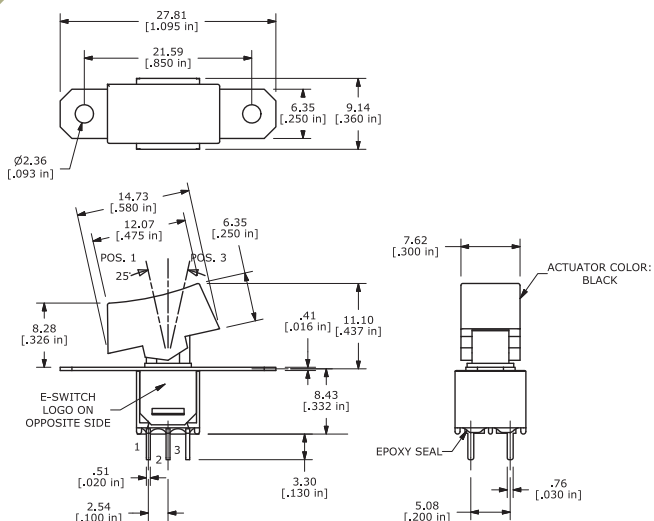
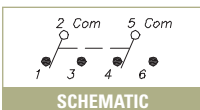

| Model No. | POS 1 | POS 2 | POS 3 |
|-------------|----------|-------|----------|
| MDP-1 | ON | NONE | ON |
| MDP-2 | ON | NONE | (ON) |
| MDP-3 | ON | OFF | ON |
| Term. Comm. | 2-3, 5-6 | OPEN | 2-1, 5-4 |

() = Momentary

ACTUATOR OPTIONS

R1



Std. all models except SPDT with M6 terminations.

R6

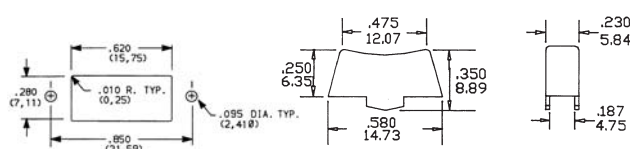

Std. on SPDT models with M6 terminations.

TERMINATION OPTIONS

M1

SOLDER LUG



Single Pole



Double Pole

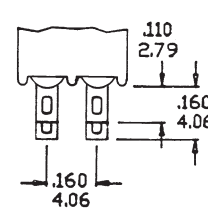

M2

P.C. MOUNT



Single Pole

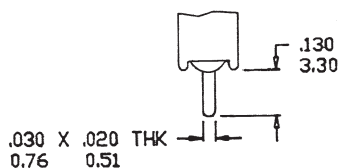

Double Pole

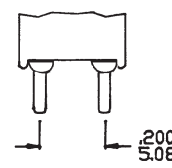



SERIES 400 SWITCHES

ROCKER SWITCHES - SUB-MINIATURE

TACT SWITCHES

NAVIGATION SWITCHES

PUSHBUTTON SWITCHES

TOGGLE SWITCHES

ROCKER SWITCHES

SLIDE SWITCHES

SNAP-ACTION SWITCHES

DIP SWITCHES

KEYLOCK SWITCHES

ROTARY SWITCHES

DETECTOR SWITCHES

CAP OPTIONS

M6

SPDT

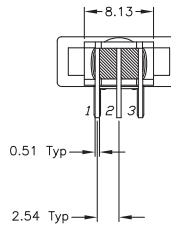
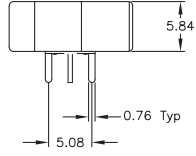

P.C. MOUNTING

M6

DPDT

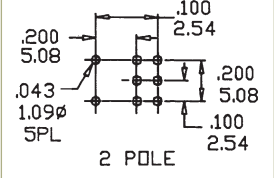
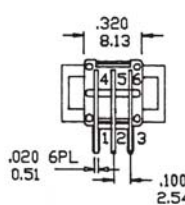
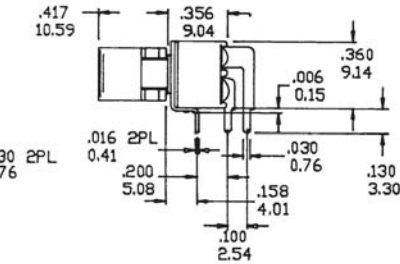
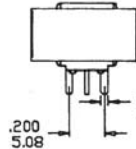
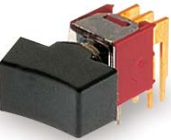

P.C. MOUNTING

M61

SPDT

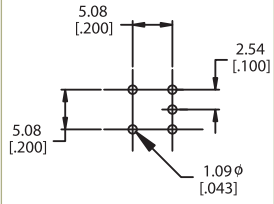
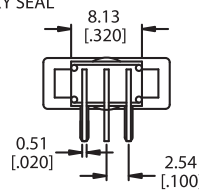
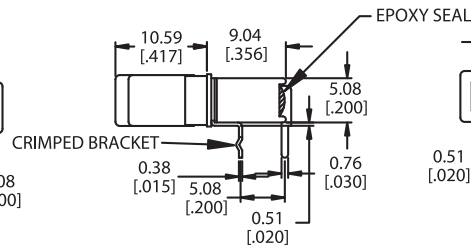

P.C. MOUNTING

M61

DPDT

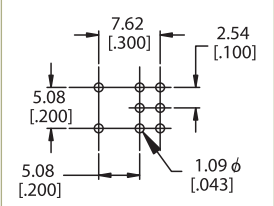
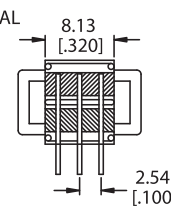
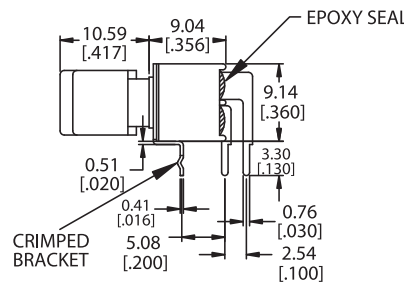
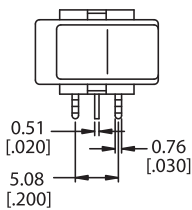

P.C. MOUNTING



M7

SPDT

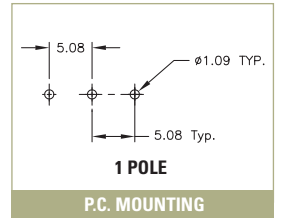

M7

DPDT

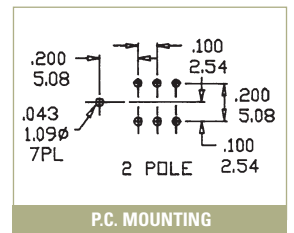

M71

SPDT

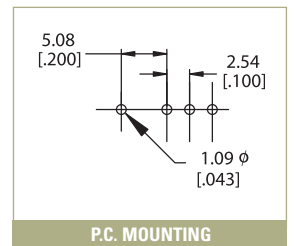

SERIES 400 SWITCHES

ROCKER SWITCHES - SUB-MINIATURE

TACT SWITCHES

NAVIGATION SWITCHES

PUSHBUTTON SWITCHES

TOGGLE SWITCHES

ROCKER SWITCHES

SLIDE SWITCHES

SNAP-ACTION SWITCHES

DIP SWITCHES

KEYLOCK SWITCHES

ROTARY SWITCHES

DETECTOR SWITCHES

CAP OPTIONS

VS2

SPDT



VS2

DPDT

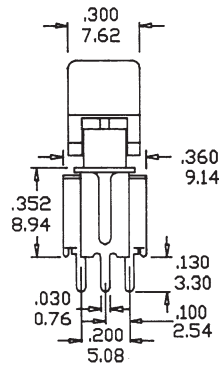

VS21

SPDT



CONTACT MATERIAL OPTIONS

Q

| | |
|-----------------|---|
| Fixed Terminal: | Silver plated copper alloy |
| Moving Contact: | Silver plated copper alloy |
| Rating: | 3 AMPS @ 120 VAC or 28 VDC; 1 AMP @ 250VAC |

R

| | |
|-----------------|--|
| Fixed Terminal: | Copper alloy with gold plate over nickel plate |
| Moving Contact: | Copper alloy with gold plate over nickel plate |
| Rating: | 0.4 VA max. @ 20 VAC or DC max. |



Компания «ЭлектроПласт» предлагает заключение долгосрочных отношений при поставках импортных электронных компонентов на взаимовыгодных условиях!

Наши преимущества:

- Оперативные поставки широкого спектра электронных компонентов отечественного и импортного производства напрямую от производителей и с крупнейших мировых складов;
- Поставка более 17-ти миллионов наименований электронных компонентов;
- Поставка сложных, дефицитных, либо снятых с производства позиций;
- Оперативные сроки поставки под заказ (от 5 рабочих дней);
- Экспресс доставка в любую точку России;
- Техническая поддержка проекта, помощь в подборе аналогов, поставка прототипов;
- Система менеджмента качества сертифицирована по Международному стандарту ISO 9001;
- Лицензия ФСБ на осуществление работ с использованием сведений, составляющих государственную тайну;
- Поставка специализированных компонентов (Xilinx, Altera, Analog Devices, Intersil, Interpoint, Microsemi, Aeroflex, Peregrine, Syfer, Eurofarad, Texas Instrument, Miteq, Cobham, E2V, MA-COM, Hittite, Mini-Circuits, General Dynamics и др.);

Помимо этого, одним из направлений компании «ЭлектроПласт» является направление «Источники питания». Мы предлагаем Вам помощь Конструкторского отдела:

- Подбор оптимального решения, техническое обоснование при выборе компонента;
- Подбор аналогов;
- Консультации по применению компонента;
- Поставка образцов и прототипов;
- Техническая поддержка проекта;
- Защита от снятия компонента с производства.



Как с нами связаться

Телефон: 8 (812) 309 58 32 (многоканальный)

Факс: 8 (812) 320-02-42

Электронная почта: org@eplast1.ru

Адрес: 198099, г. Санкт-Петербург, ул. Калинина, дом 2, корпус 4, литера А.