



# SERIES 400 SWITCHES

## ROCKER SWITCHES - SUB-MINIATURE

TACT SWITCHES

NAVIGATION SWITCHES

PUSHBUTTON SWITCHES

TOGGLE SWITCHES

ROCKER SWITCHES

SLIDE SWITCHES

SNAP-ACTION SWITCHES

DIP SWITCHES

KEYLOCK SWITCHES

ROTARY SWITCHES

DETECTOR SWITCHES

CAP OPTIONS

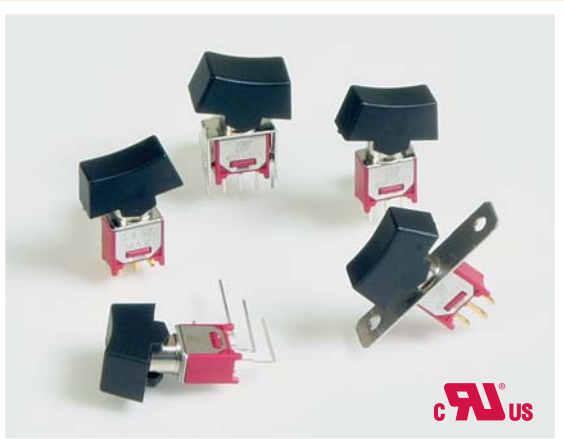

### FEATURES & BENEFITS

- ▶ Variety of switching functions
- ▶ Sub-miniature
- ▶ Multiple actuator options

### APPLICATIONS/MARKETS

- ▶ Telecommunications
- ▶ Instrumentation
- ▶ Test equipment
- ▶ Networking
- ▶ Computer peripherals

### SPECIFICATIONS

Contact Rating:	See contact material options
Life Expectancy:	30,000 make-and-break cycles at full load
Contact Resistance:	20 mΩ max. typical initial @ 2-4 VDC 100 mA for silver and gold plated contacts
Insulation Resistance:	1,000 MΩ min
Dielectric Strength:	1,000 V RMS @ sea level
Operating Temperature:	-30° C to 85° C

### MATERIALS

Case:	Diallyl phthalate (DAP) or glass filled nylon, flame retardant, heat stabilized (UL 94-V0)
Rocker:	Nylon
Bushing:	Brass, nickel plated
Housing:	Stainless steel
Terminal/Switch Support:	Brass, or steel tin plated
Contacts / Terminals:	Silver or gold plated copper alloy

### HOW TO ORDER

SERIES	MODEL NO.	ACTUATOR	ACTUATOR COLOR	TERMINATION	CONTACT MATERIAL	SEAL
400	□ □ □ □ □	□ □	□ □ □	□ □ □ □	□	E
	MSP1 MSP2 MSP3 MSP4 MSP5 MSP6***	R1* R6**	BLK =Black WHT=White RED =Red	M1 M2 M6 M61 M7 M71 VS2 VS21	Q = Silver R = Gold	E = Epoxy Sealed at Base of Terminal

### Example Ordering Number

400-MSP1-R6-BLK-M6-R-E

\* Std. all models except SPDT with M6 + M61 terminations.

\*\* Std. on SPDT models with M6 + M61 terminations.

\*\*\* Not available with M6 terminations.

Specifications subject to change without notice.

### SPDT

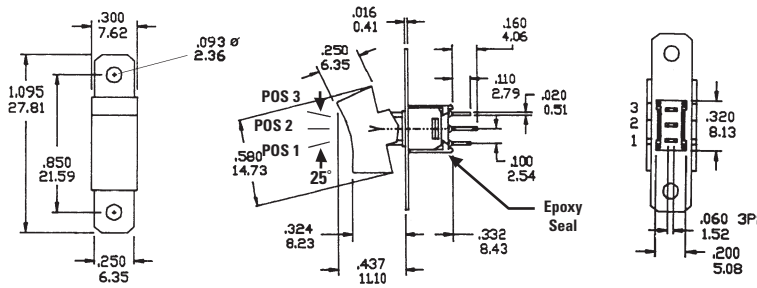

Model No.	POS 1	POS 2	POS 3
MSP-1	ON	NONE	ON
MSP-2	ON	NONE	(ON)
MSP-3	ON	OFF	ON
MSP-4	(ON)	OFF	(ON)
MSP-5	ON	OFF	(ON)
MSP-6	OFF	NONE	ON
Term. Comm.	2-3	OPEN	2-1

( ) = Momentary

2 Comm.  
1 3

SCHEMATIC



# DPDT

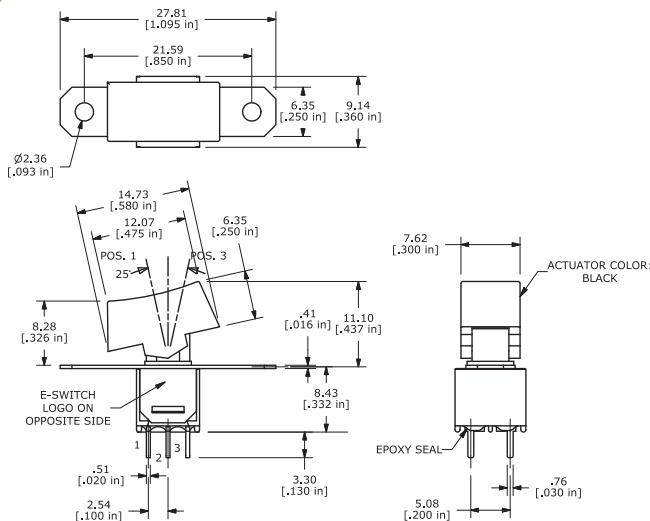
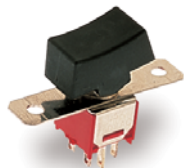

Model No.	POS 1	POS 2	POS 3
MDP-1	ON	NONE	ON
MDP-2	ON	NONE	(ON)
MDP-3	ON	OFF	ON
Term. Comm.	2-3, 5-6	OPEN	2-1, 5-4

( ) = Momentary

## ACTUATOR OPTIONS

### R1



Std. all models except SPDT with M6 terminations.

### R6

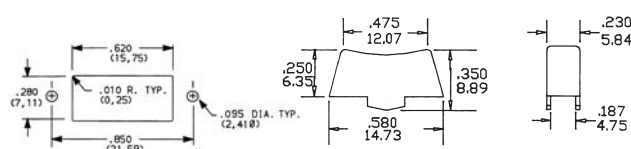

Std. on SPDT models with M6 terminations.

## TERMINATION OPTIONS

### M1

#### SOLDER LUG



#### Single Pole



#### Double Pole

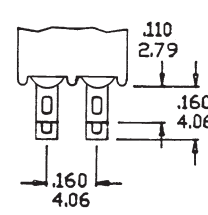

### M2

#### P.C. MOUNT



#### Single Pole

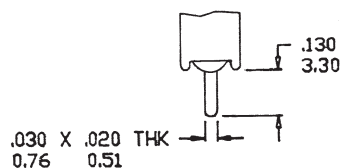

#### Double Pole

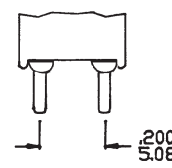



# SERIES 400 SWITCHES

## ROCKER SWITCHES - SUB-MINIATURE

TACT SWITCHES

NAVIGATION SWITCHES

PUSHBUTTON SWITCHES

TOGGLE SWITCHES

ROCKER SWITCHES

SLIDE SWITCHES

SNAP-ACTION SWITCHES

DIP SWITCHES

KEYLOCK SWITCHES

ROTARY SWITCHES

DETECTOR SWITCHES

CAP OPTIONS

### M6

SPDT

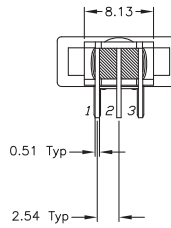
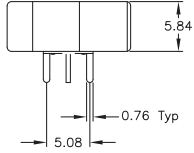

P.C. MOUNTING

### M6

DPDT

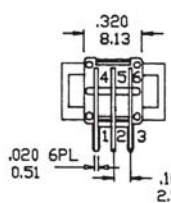
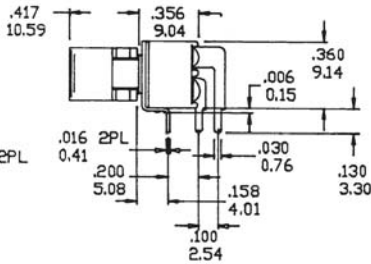
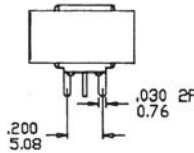
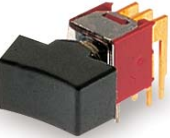

P.C. MOUNTING

### M61

SPDT

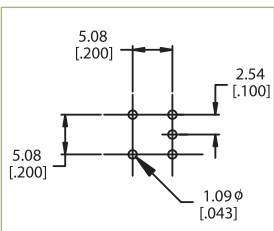
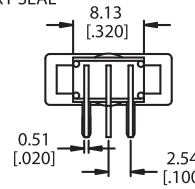
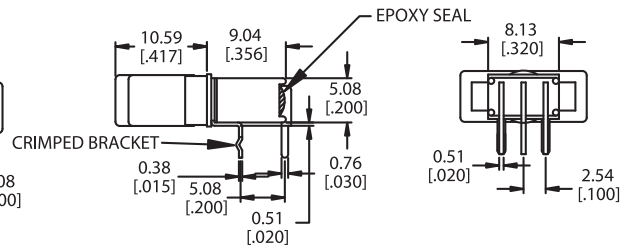
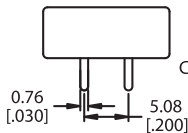

P.C. MOUNTING

### M61

DPDT

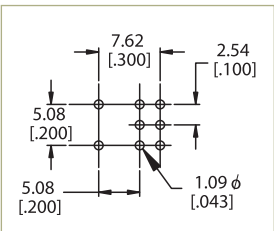
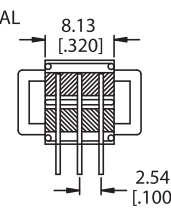
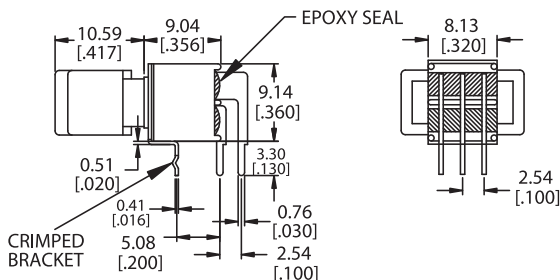
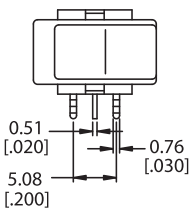

P.C. MOUNTING



### M7

SPDT



### M7

DPDT

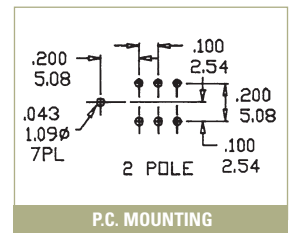

### M71

SPDT



- TACT SWITCHES
- NAVIGATION SWITCHES
- PUSHBUTTON SWITCHES
- TOGGLE SWITCHES
- ROCKER SWITCHES
- SLIDE SWITCHES
- SNAP-ACTION SWITCHES
- DIP SWITCHES
- KEYLOCK SWITCHES
- ROTARY SWITCHES
- DETECTOR SWITCHES
- CAP OPTIONS

# SERIES 400 SWITCHES

## ROCKER SWITCHES - SUB-MINIATURE

TACT SWITCHES

NAVIGATION SWITCHES

PUSHBUTTON SWITCHES

TOGGLE SWITCHES

ROCKER SWITCHES

SLIDE SWITCHES

SNAP-ACTION SWITCHES

DIP SWITCHES

KEYLOCK SWITCHES

ROTARY SWITCHES

DETECTOR SWITCHES

CAP OPTIONS

### VS2

SPDT



### VS2

DPDT

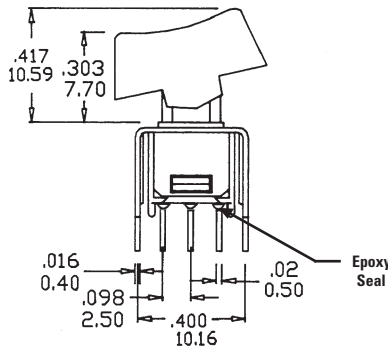
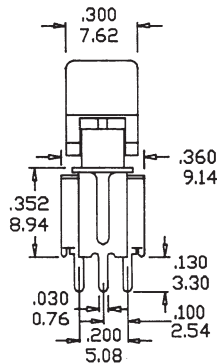

### VS21

SPDT

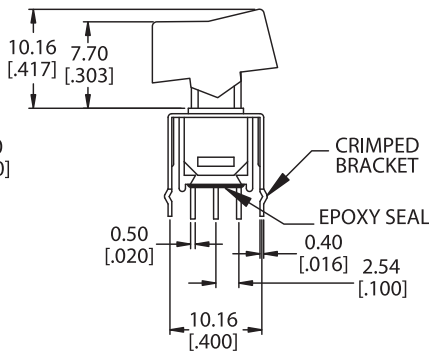
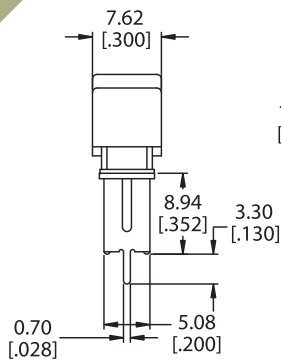

### CONTACT MATERIAL OPTIONS

**Q**

Fixed Terminal:	Silver plated copper alloy
Moving Contact:	Silver plated copper alloy
Rating:	3 AMPS @ 120 VAC or 28 VDC; 1 AMP @ 250VAC

**R**

Fixed Terminal:	Copper alloy with gold plate over nickel plate
Moving Contact:	Copper alloy with gold plate over nickel plate
Rating:	0.4 VA max. @ 20 VAC or DC max.



Компания «ЭлектроПласт» предлагает заключение долгосрочных отношений при поставках импортных электронных компонентов на взаимовыгодных условиях!

Наши преимущества:

- Оперативные поставки широкого спектра электронных компонентов отечественного и импортного производства напрямую от производителей и с крупнейших мировых складов;
- Поставка более 17-ти миллионов наименований электронных компонентов;
- Поставка сложных, дефицитных, либо снятых с производства позиций;
- Оперативные сроки поставки под заказ (от 5 рабочих дней);
- Экспресс доставка в любую точку России;
- Техническая поддержка проекта, помощь в подборе аналогов, поставка прототипов;
- Система менеджмента качества сертифицирована по Международному стандарту ISO 9001;
- Лицензия ФСБ на осуществление работ с использованием сведений, составляющих государственную тайну;
- Поставка специализированных компонентов (Xilinx, Altera, Analog Devices, Intersil, Interpoint, Microsemi, Aeroflex, Peregrine, Syfer, Eurofarad, Texas Instrument, Miteq, Cobham, E2V, MA-COM, Hittite, Mini-Circuits, General Dynamics и др.);

Помимо этого, одним из направлений компании «ЭлектроПласт» является направление «Источники питания». Мы предлагаем Вам помощь Конструкторского отдела:

- Подбор оптимального решения, техническое обоснование при выборе компонента;
- Подбор аналогов;
- Консультации по применению компонента;
- Поставка образцов и прототипов;
- Техническая поддержка проекта;
- Защита от снятия компонента с производства.



#### Как с нами связаться

**Телефон:** 8 (812) 309 58 32 (многоканальный)

**Факс:** 8 (812) 320-02-42

**Электронная почта:** [org@eplast1.ru](mailto:org@eplast1.ru)

**Адрес:** 198099, г. Санкт-Петербург, ул. Калинина, дом 2, корпус 4, литера А.