

**TV-4 rated.
2a 3A/5A power relays**

LA RELAYS (ALA)



RoHS compliant

FEATURES

- 1. 2 Form A slim type**
24(L) × 12(W) × 25(H) mm
.945(L)×.472(W)×.984(H) inch
- 2. 3A type and 5A TV type**
3A type: Contact reliability and break performance best suited for protecting and switching speakers.
5A TV type: Tough against inrush current and optimal for turning on and off the power supply. Rated TV-4 (UL, CSA).
- 3. High insulation resistance**
 - Creepage distance and clearances between contact and coil: Min. 6 mm .236 inch (In compliance with IEC65)
 - Surge withstand voltage between contact and coil: 10,000 V

- 4. High noise immunity realized by the card separation structure between contact and coil**
- 5. Conforms to the various safety standards**
 - UL, CSA, VDE, TÜV, SEMKO approved

TYPICAL APPLICATIONS

- Audio devices
- Monitor
- Automatic vending machine

ORDERING INFORMATION

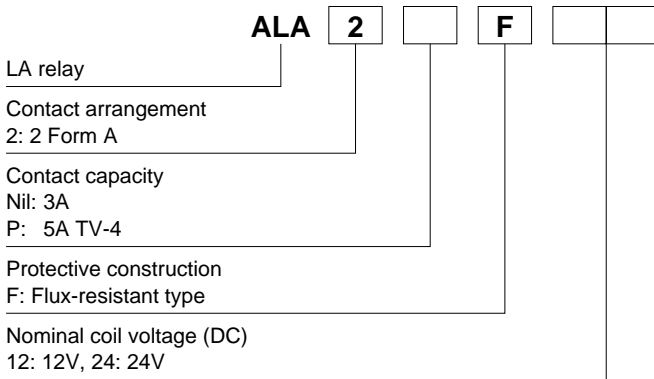

Note: Certified by UL, CSA, VDE, TÜV, SEMKO and TV-4

TYPES

Contact arrangement	Coil voltage	Part No.	
		3A type	5A TV type (TV-4)
2 Form A	12V DC	ALA2F12	ALA2PF12
	24V DC	ALA2F24	ALA2PF24

Standard packing Carton: 100 pcs. Case: 500 pcs.
Note: 4.5V, 5V, 9V and 18V DC types are also available. Please consult us for details.

RATING

1. Coil data

Nominal coil voltage	Pick-up voltage (at 20°C 68°F)	Drop-out voltage (at 20°C 68°F)	Nominal operating current [±10%] (at 20°C 68°F)	Coil resistance [±10%] (at 20°C 68°F)	Nominal operating power	Max. applied voltage (at 20°C 68°F)
12V DC	75%V or less of nominal voltage (Initial)	5%V or more of nominal voltage (Initial)	44.2mA	272Ω	530mW	15.6V DC
24V DC			22.1mA	1,087Ω		31.2V DC

2. Specifications

Characteristics	Item	Specifications	
		3A type	5A TV type (TV-4)
Contact	Arrangement	2 Form A	
	Contact resistance (Initial)	Max. 50 mΩ (By voltage drop 6V DC 1A)	Max. 100 mΩ (By voltage drop 6V DC 1A)
	Contact material	Gold-clad, AgNi type	AgSnO ₂ type
Rating	Nominal switching capacity (resistive load)	3A 125V AC	5A 277V AC
	Max. switching power (resistive load)	625VA	1,385VA
	Max. switching voltage	125V AC	277V AC
	Max. switching current	5A (AC)	
	Min. switching capacity*1	100mA 5V DC	
Electrical characteristics	Insulation resistance (Initial)	Min. 1,000MΩ (at 500V DC) Measurement at same location as "Breakdown voltage" section.	
	Breakdown voltage (Initial)	Between contact sets	1,000 Vrms for 1 min. (Detection current: 10 mA)
		Between open contacts	1,000 Vrms for 1 min. (Detection current: 10 mA)
		Between contact and coil	4,000 Vrms for 1 min. (Detection current: 10 mA)
	Temperature rise (coil)	Max. 45°C 113°F (with nominal coil voltage and at 3 A contact carrying current, at 70°C 158°F)	Max. 45°C 113°F (with nominal coil voltage and at 5 A contact carrying current, at 70°C 158°F)
	Surge breakdown voltage*2 (Between contact and coil) (Initial)	10,000 V	
	Operate time (at nominal voltage) (at 20°C 68°F)	Max. 15 ms (excluding contact bounce time.)	
Release time (at nominal voltage) (at 20°C 68°F)	Max. 15 ms (excluding contact bounce time) (With diode)		
Mechanical characteristics	Shock resistance	Functional	200 m/s ² (Half-wave pulse of sine wave: 11 ms; detection time: 10μs.)
		Destructive	1,000 m/s ² (Half-wave pulse of sine wave: 6 ms.)
	Vibration resistance	Functional	10 to 55 Hz at double amplitude of 1.5 mm (Detection time: 10μs.)
		Destructive	10 to 55 Hz at double amplitude of 1.5 mm
Expected life	Mechanical	Min. 10 ⁶ (at 180 times/min.)	
	Electrical (at 20 times/min.)	Min. 5×10 ⁴ (ON: OFF=1.5s: 1.5s) (at nominal switching capacity)	
Conditions	Conditions for operation, transport and storage*3	Ambient temperature: -40°C to +70°C -40°F to +158°F, Humidity: 5 to 85% R.H. (Not freezing and condensing at low temperature), Air pressure: 86 to 106kPa	
	Max. operating speed	20 times/min. (at nominal switching capacity)	
Unit weight		Approx. 13 g .46 oz	

Notes: *1. This value can change due to the switching frequency, environmental conditions, and desired reliability level, therefore it is recommended to check this with the actual load.

*2. Wave is standard shock voltage of ±1.2×50μs according to JEC-212-1981

*3. The upper limit of the ambient temperature is the maximum temperature that can satisfy the coil temperature rise value. Refer to Usage, transport and storage conditions in NOTES.

REFERENCE DATA

1. Max. switching power (AC resistive load)

2-(1). Life curve (250 V AC resistive load)

2-(2). Life curve (125 V AC resistive load)

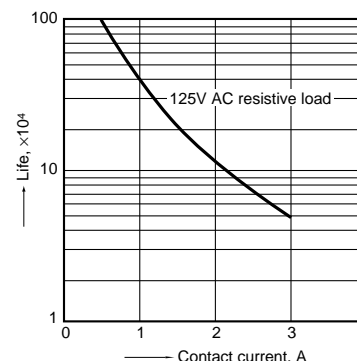
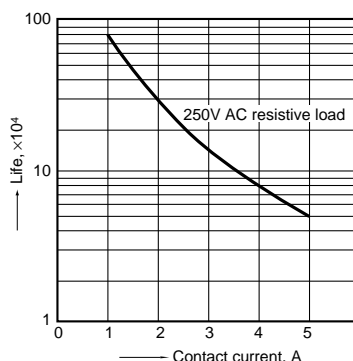
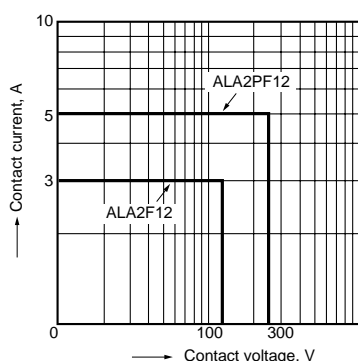

LA (ALA)

3-(1). Coil temperature rise

Sample: ALA2F12, 6 pcs.
Measured portion: coil inside
Contact current: 0 A, 3A

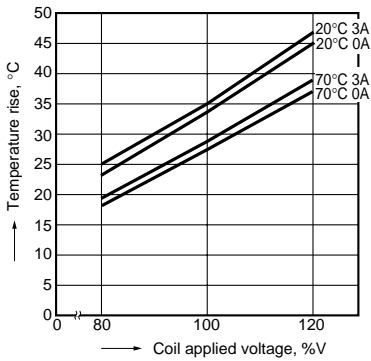

3-(2). Coil temperature rise

Sample: ALA2PF12, 6 pcs.
Measured portion: coil inside
Contact current: 0 A, 5A

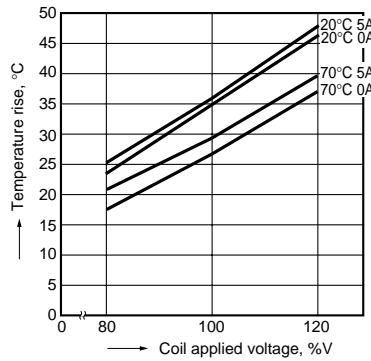

4. Ambient temperature characteristics and coil applied voltage

Contact current: ALA2F=3A
ALA2PF=5A

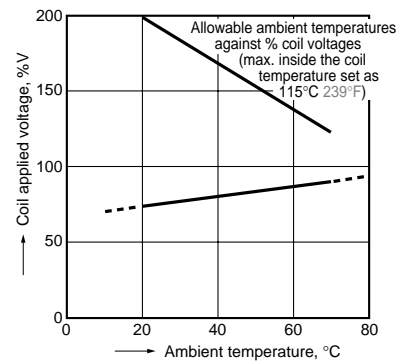

5-(1). Electrical life test

(3 A 125 V AC, resistive load)

Sample: ALA2F12, 6 pcs.
Operation frequency: 20 times/min.
(ON/OFF = 1.5s: 1.5s)
Ambient temperature: 20°C 68°F

Circuit:

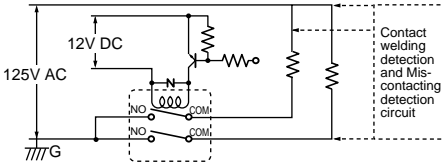

Change of pick-up and drop-out voltage

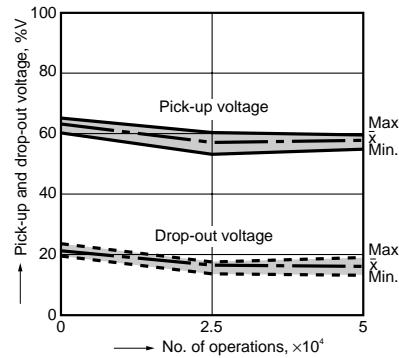

Change of contact resistance

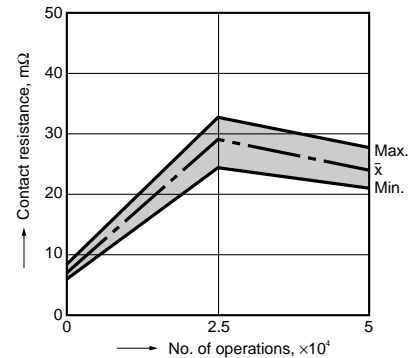

5-(2). Electrical life test

(5 A 250 V AC, resistive load)

Sample: ALA2PF12, 6 pcs.
Operation frequency: 20 times/min.
(ON/OFF = 1.5s: 1.5s)
Ambient temperature: 20°C 68°F

Circuit:

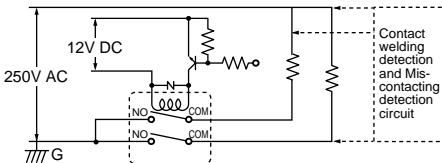

Change of pick-up and drop-out voltage

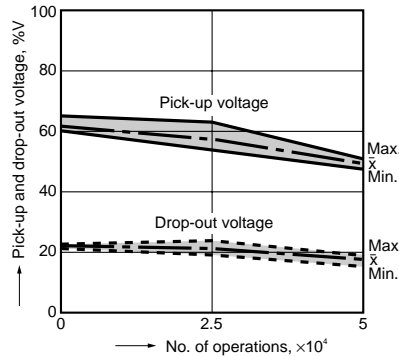

Change of contact resistance

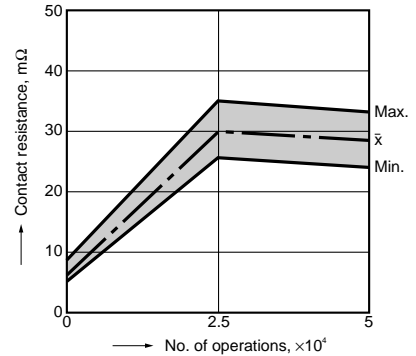

5-(3). Electrical life test

(UL lamp load test TV-4)

Tested sample: ALA2PF12, 6 pcs.

- Overload test
Load: 6.0 A 120 V AC (60 Hz),
Inrush: 91 A
Operation frequency: 10 times/min
(ON: OFF = 1 s: 5 s)
No. of operations: 50 ope.
- Endurance test
Load: 4A 120 V AC (60 Hz),
Inrush: 65 A
Operation frequency: 10 times/min
(ON: OFF = 1 s: 5 s)
No. of operations: 25,000 ope.

Change of pick-up and drop-out voltage

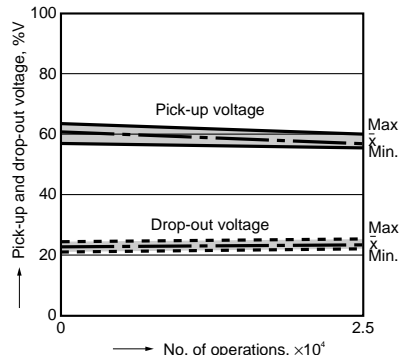

Change of contact resistance

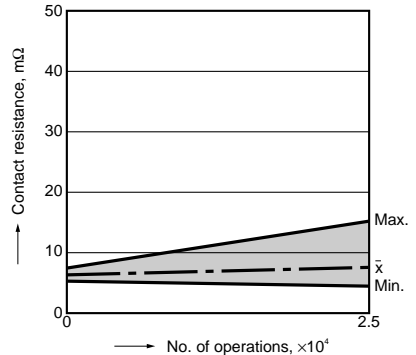

DIMENSIONS (mm inch)

The CAD data of the products with a **CAD Data** mark can be downloaded from: <http://industrial.panasonic.com/ac/e/>

CAD Data



External dimensions

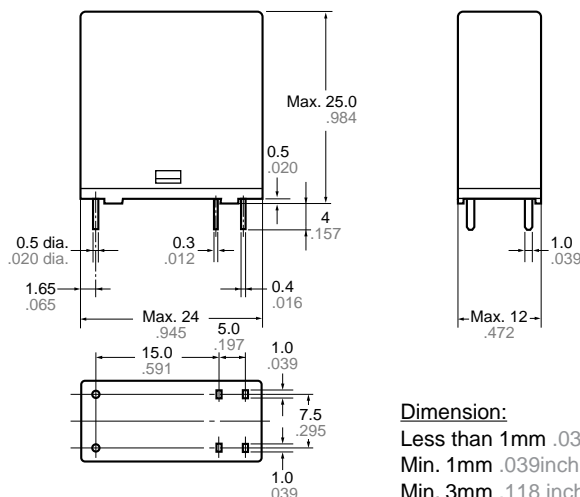

PC board pattern (Bottom view)

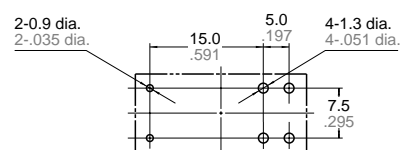

Tolerance : $\pm 0.1 \pm 0.004$

Schematic (Bottom view)



Dimension:

Less than 1mm .039inch:

Min. 1mm .039inch less than 3mm .118 inch:

Min. 3mm .118 inch:

General tolerance

$\pm 0.1 \pm 0.004$

$\pm 0.2 \pm 0.008$

$\pm 0.3 \pm 0.012$

SAFETY STANDARDS

Item	UL/C-UL (Recognized)		CSA (Certified)		VDE (Certified)		TV rating (UL/CSA)		TÜV (Certified)		SEMKO (Certified)	
	File No.	Contact rating	File No.	Contact rating	File No.	Contact rating	File No.	Rating	File No.	Rating	File No.	Contact rating
Standard	E43149	3A 125V AC 3A 30V DC 5A 50V DC	LR26550 etc.	3A 125V AC 3A 30V DC 5A 50V DC	40012000	3A 125V AC (cosφ=1.0) 3A 30V DC (0ms)	—	—	B 11 05 13461 298	3A 125V AC (cosφ=1.0) 3A 30V DC (0ms)	817139	3A 125V AC 3A 30V DC
High capacity	E43149	5A 277V AC 5A 30V DC	LR26550 etc.	5A 277V AC 5A 30V DC	40012000	5A 250V AC (cosφ=1.0) 5A 30V DC (0ms)	UL E43149 CSA LR26550	TV-4	B 11 05 13461 298	5A 250V AC (cosφ=1.0) 5A 30V DC (0ms)	817139	4/65A 250V AC

For Cautions for Use.

Mouser Electronics

Authorized Distributor

Click to View Pricing, Inventory, Delivery & Lifecycle Information:

Panasonic:

[ALA2F09](#) [ALA2F12](#) [ALA2F18](#) [ALA2F4H](#) [ALA2PF05](#) [ALA2PF09](#) [ALA2PF18](#) [ALA2PF24](#) [ALA2PF4H](#) [ALA2PFB06](#)
[ALA2F24](#) [ALA2PF12](#) [ALA2F05](#)



Компания «ЭлектроПласт» предлагает заключение долгосрочных отношений при поставках импортных электронных компонентов на взаимовыгодных условиях!

Наши преимущества:

- Оперативные поставки широкого спектра электронных компонентов отечественного и импортного производства напрямую от производителей и с крупнейших мировых складов;
- Поставка более 17-ти миллионов наименований электронных компонентов;
- Поставка сложных, дефицитных, либо снятых с производства позиций;
- Оперативные сроки поставки под заказ (от 5 рабочих дней);
- Экспресс доставка в любую точку России;
- Техническая поддержка проекта, помощь в подборе аналогов, поставка прототипов;
- Система менеджмента качества сертифицирована по Международному стандарту ISO 9001;
- Лицензия ФСБ на осуществление работ с использованием сведений, составляющих государственную тайну;
- Поставка специализированных компонентов (Xilinx, Altera, Analog Devices, Intersil, Interpoint, Microsemi, Aeroflex, Peregrine, Syfer, Eurofarad, Texas Instrument, Miteq, Cobham, E2V, MA-COM, Hittite, Mini-Circuits, General Dynamics и др.);

Помимо этого, одним из направлений компании «ЭлектроПласт» является направление «Источники питания». Мы предлагаем Вам помощь Конструкторского отдела:

- Подбор оптимального решения, техническое обоснование при выборе компонента;
- Подбор аналогов;
- Консультации по применению компонента;
- Поставка образцов и прототипов;
- Техническая поддержка проекта;
- Защита от снятия компонента с производства.



Как с нами связаться

Телефон: 8 (812) 309 58 32 (многоканальный)

Факс: 8 (812) 320-02-42

Электронная почта: org@eplast1.ru

Адрес: 198099, г. Санкт-Петербург, ул. Калинина, дом 2, корпус 4, литера А.