

**PKJ 4000 RFPA series** Direct Converters  
 Input 36-75 V, Output up to 12.4 A / 350 W

EN/LZT 146 367 R3B September 2009

© Ericsson AB

**Key Features**

- Industry standard Half-brick  
 61.00 x 57.90 x 12.70 mm (2.40 x 2.28 x 0.50 in.)
- High efficiency, typ. 91.5 % at 30.2Vout half load
- 1500 Vdc input to output isolation
- Meets isolation requirements equivalent to basic insulation according to IEC/EN/UL 60950
- 3 million hours predicted MTBF

**General Characteristics**

- Output over-voltage protection
- Input under-voltage shutdown
- Over temperature protection
- Output short-circuit protection
- Remote sense
- Remote control
- Output voltage adjust function
- Highly automated manufacturing ensures quality
- ISO 9001/14001 certified supplier



**Safety Approvals**



**Design for Environment**



Meets requirements in high-temperature lead-free soldering processes.

**Contents**

General Information	.....	2
Safety Specification	.....	3
Absolute Maximum Ratings	.....	4
Product Program	Ordering No.	
28.2V, 11A / 310W Electrical Specification	PKJ 4316 PI .....	5
28.2V/12.4A / 350W Electrical Specification	PKJ 4316 API .....	8
30.2V/8.3A / 250W Electrical Specification	PKJ 4216N PI .....	11
28.2V/8.3A /230W Electrical Specification	PKJ 4216 PI .....	14
EMC Specification	.....	18
Operating Information	.....	19
Thermal Consideration	.....	20
Connections	.....	22
Mechanical Information	.....	23
Soldering Information	.....	24
Delivery Information	.....	24
Product Qualification Specification	.....	25

**PKJ 4000 RFP series** Direct Converters  
 Input 36-75 V, Output up to 12.4 A / 350 W

EN/LZT 146 367 R3B September 2009

© Ericsson AB

**General Information**

**Ordering Information**

See Contents for individual product ordering numbers.

Option	Suffix	Ordering No.
Non-threaded standoff	M	PKJ 4316 PIM
Lead length 3.69 mm(0.145 in)	LA	PKJ 4316 PILA

Note: As an example a non-threaded standoff, short pin product would be PKJ 4316 PIMLA.

**Reliability**

The Mean Time Between Failure (MTBF) is calculated at full output power and an operating ambient temperature (T<sub>A</sub>) of +40°C, which is a typical condition in Information and Communication Technology (ICT) equipment. Different methods could be used to calculate the predicted MTBF and failure rate which may give different results. Ericsson Power Modules currently uses Telcordia SR332.

Predicted MTBF for the series is:

- 3 million hours according to Telcordia SR332, issue 1, Black box technique.

Telcordia SR332 is a commonly used standard method intended for reliability calculations in ICT equipment. The parts count procedure used in this method was originally modelled on the methods from MIL-HDBK-217F, Reliability Predictions of Electronic Equipment. It assumes that no reliability data is available on the actual units and devices for which the predictions are to be made, i.e. all predictions are based on generic reliability parameters.

**Compatibility with RoHS requirements**

The products are compatible with the relevant clauses and requirements of the RoHS directive 2002/95/EC and have a maximum concentration value of 0.1% by weight in homogeneous materials for lead, mercury, hexavalent chromium, PBB and PBDE and of 0.01% by weight in homogeneous materials for cadmium.

Exemptions in the RoHS directive utilized in Ericsson Power Modules products include:

- Lead in high melting temperature type solder (used to solder the die in semiconductor packages)
- Lead in glass of electronics components and in electronic ceramic parts (e.g. fill material in chip resistors)
- Lead as an alloying element in copper alloy containing up to 4% lead by weight (used in connection pins made of Brass)

**Quality Statement**

The products are designed and manufactured in an industrial environment where quality systems and methods like ISO 9000, 6σ (sigma), and SPC are intensively in use to boost the continuous improvements strategy. Infant mortality or early failures in the products are screened out and they are subjected to an ATE-based final test. Conservative design rules, design reviews and product qualifications, plus the high competence of an engaged work force, contribute to the high quality of our products.

**Warranty**

Warranty period and conditions are defined in Ericsson Power Modules General Terms and Conditions of Sale.

**Limitation of Liability**

Ericsson Power Modules does not make any other warranties, expressed or implied including any warranty of merchantability or fitness for a particular purpose (including, but not limited to, use in life support applications, where malfunctions of product can cause injury to a person's health or life).

**PKJ 4000 RFPA series** Direct Converters  
Input 36-75 V, Output up to 12.4 A / 350 W

EN/LZT 146 367 R3B September 2009

© Ericsson AB

## Safety Specification

### General information

Ericsson Power Modules DC/DC converters and DC/DC regulators are designed in accordance with safety standards IEC/EN/UL60950, *Safety of Information Technology Equipment*.

IEC/EN/UL60950 contains requirements to prevent injury or damage due to the following hazards:

- Electrical shock
- Energy hazards
- Fire
- Mechanical and heat hazards
- Radiation hazards
- Chemical hazards

On-board DC-DC converters are defined as component power supplies. As components they cannot fully comply with the provisions of any Safety requirements without "Conditions of Acceptability". It is the responsibility of the installer to ensure that the final product housing these components complies with the requirements of all applicable Safety standards and Directives for the final product.

Component power supplies for general use should comply with the requirements in IEC60950, EN60950 and UL60950 "*Safety of information technology equipment*".

There are other more product related standards, e.g. IEEE802.3af "Ethernet LAN/MAN Data terminal equipment power", and ETS300132-2 "Power supply interface at the input to telecommunications equipment; part 2: DC", but all of these standards are based on IEC/EN/UL60950 with regards to safety.

Ericsson Power Modules DC/DC converters and DC/DC regulators are UL60950 recognized and certified in accordance with EN60950.

The flammability rating for all construction parts of the products meets requirements for V-0 class material according to IEC 60695-11-10.

The products should be installed in the end-use equipment, in accordance with the requirements of the ultimate application. Normally the output of the DC/DC converter is considered as SELV (Safety Extra Low Voltage) and the input source must be isolated by minimum Double or Reinforced Insulation from the primary circuit (AC mains) in accordance with IEC/EN/UL60950.

### Isolated DC/DC converters

It is recommended that a slow blow fuse with a rating twice the maximum input current per selected product be used at the input of each DC/DC converter. If an input filter is used in the circuit the fuse should be placed in front of the input filter.

In the rare event of a component problem in the input filter or in the DC/DC converter that imposes a short circuit on the input source, this fuse will provide the following functions:

- Isolate the faulty DC/DC converter from the input power source so as not to affect the operation of other parts of the system.
- Protect the distribution wiring from excessive current and power loss thus preventing hazardous overheating.

The galvanic isolation is verified in an electric strength test. The test voltage ( $V_{iso}$ ) between input and output is 1500 Vdc or 2250 Vdc for 60 seconds (refer to product specification).

Leakage current is less than 1  $\mu$ A at nominal input voltage.

### 24 V DC systems

The input voltage to the DC/DC converter is SELV (Safety Extra Low Voltage) and the output remains SELV under normal and abnormal operating conditions.

### 48 and 60 V DC systems

If the input voltage to Ericsson Power Modules DC/DC converter is 75 Vdc or less, then the output remains SELV (Safety Extra Low Voltage) under normal and abnormal operating conditions.

Single fault testing in the input power supply circuit should be performed with the DC/DC converter connected to demonstrate that the input voltage does not exceed 75 Vdc.

If the input power source circuit is a DC power system, the source may be treated as a TNV2 circuit and testing has demonstrated compliance with SELV limits and isolation requirements equivalent to Basic Insulation in accordance with IEC/EN/UL60950.

### Non-isolated DC/DC regulators

The input voltage to the DC/DC regulator is SELV (Safety Extra Low Voltage) and the output remains SELV under normal and abnormal operating conditions.

**PKJ 4000 RFPA series** Direct Converters  
 Input 36-75 V, Output up to 12.4 A / 350 W

EN/LZT 146 367 R3B September 2009

© Ericsson AB

**Absolute Maximum Ratings**

Characteristics		min	typ	max	Unit
$T_{ref}$	Operating Temperature (see Thermal Consideration section)	-40		+120	°C
$T_s$	Storage temperature	-55		+125	°C
$V_I$	Input voltage	-0.5		+80	V
$V_{iso}$	Isolation voltage (input to output test voltage)			1500	Vdc
$V_{tr}$	Input voltage transient ( $t_p$ 100 ms)			100	V
$V_{RC}$	Remote Control pin voltage (see Operating Information section)	Positive logic option		20	V
		Negative logic option		20	V
$V_{adj}$	Adjust pin voltage (see Operating Information section)	-0.5		28	V

Stress in excess of Absolute Maximum Ratings may cause permanent damage. Absolute Maximum Ratings, sometimes referred to as no destruction limits, are normally tested with one parameter at a time exceeding the limits of Output data or Electrical Characteristics. If exposed to stress above these limits, function and performance may degrade in an unspecified manner.

**Fundamental Circuit Diagram**

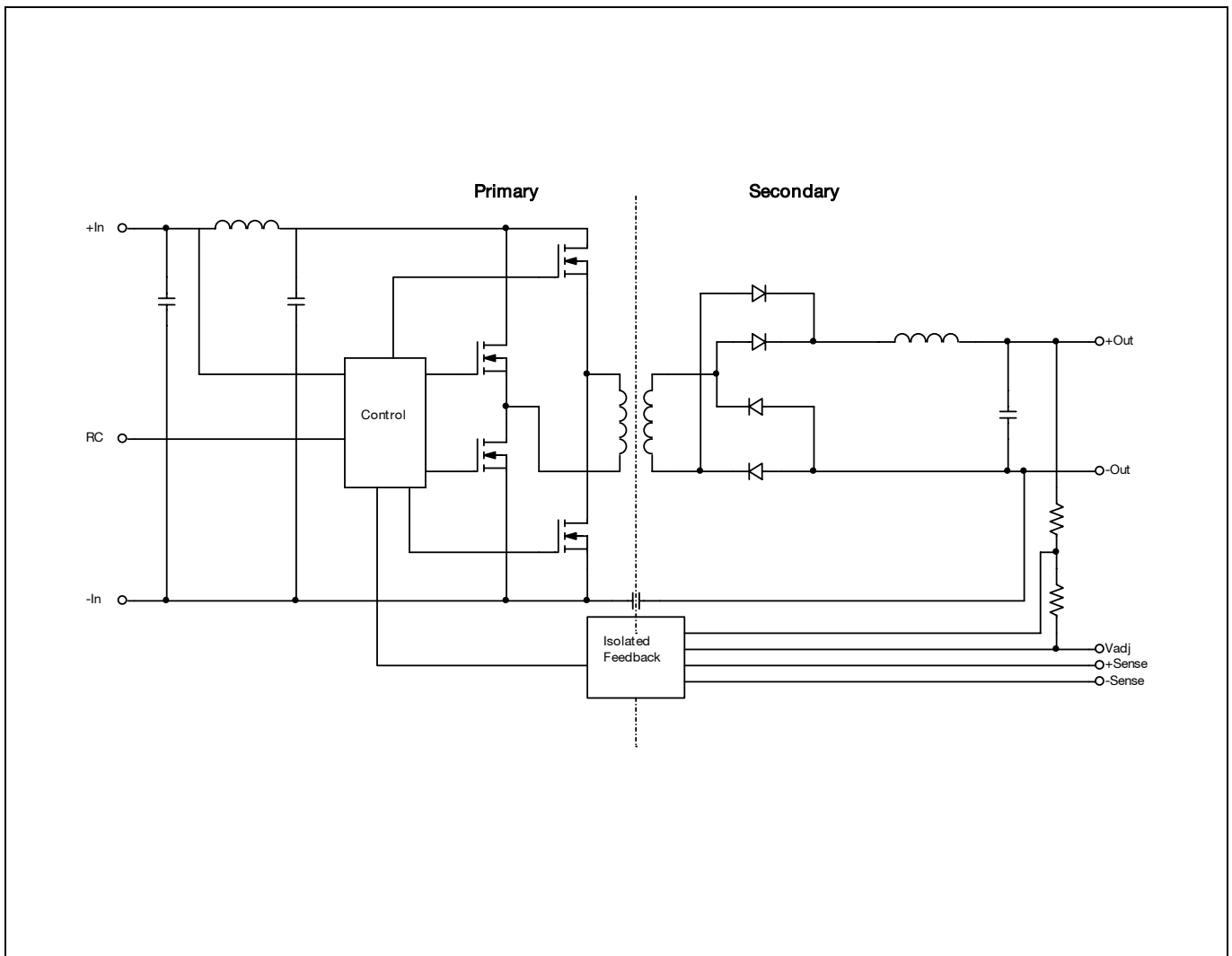

**PKJ 4000 RFPA series Direct Converters**  
 Input 36-75 V, Output up to 12.4 A / 350 W

EN/LZT 146 367 R3B September 2009

© Ericsson AB

**28.2 V/11 A Electrical Specification**
**PKJ 4316 PI**
 $T_{ref} = -40$  to  $+90^{\circ}\text{C}$ ,  $V_I = 35$  to  $75$  V, unless otherwise specified under Conditions.

 Typical values given at:  $T_{ref} = +25^{\circ}\text{C}$ ,  $V_I = 53$  V, max  $I_O$ , unless otherwise specified under Conditions.

Characteristics		Conditions	min	typ	max	Unit
$V_I$	Input voltage range		35		75	V
$V_{loff}$	Turn-off input voltage	Decreasing input voltage	30	33.5	35	V
$V_{lon}$	Turn-on input voltage	Increasing input voltage	32	34.5	36	V
$C_I$	Internal input capacitance			10		$\mu\text{F}$
$P_O$	Output power	Output voltage initial setting	0		310	W
SVR	Supply voltage rejection (ac)	$f = 100$ Hz sinewave, 1 Vp-p		40		dB
$\eta$	Efficiency	50 % of max $I_O$		91.0		%
		max $I_O$ , $T_{ref} = +25^{\circ}\text{C}$	88.8	89		
		50 % of max $I_O$ , $V_I = 48$ V		91.0		
		max $I_O$ , $V_I = 48$ V, $T_{ref} = +25^{\circ}\text{C}$	88.8	89		
$P_d$	Power Dissipation	max $I_O$ , $T_{ref} = +25^{\circ}\text{C}$		38.3	39.4	W
$P_{li}$	Input idling power	$I_O = 0$ , $V_I = 53$ V		3		W
$P_{RC}$	Input standby power	$V_I = 53$ V (turned off with RC)		150		mW
$f_s$	Switching frequency	0 -100% of max $I_O$	190	210	230	kHz

$V_{Oi}$	Output voltage initial setting and accuracy	$T_{ref} = +25^{\circ}\text{C}$ , $V_I = 53$ V, $I_O = 12.4$ A	27.93	28.2	28.47	V
	Output adjust range	See operation information & see Note 1	19.74		30.17	V
$V_O$	Output voltage tolerance band	10-100% of max $I_O$	27.85		28.55	V
	Idling voltage	$I_O = 0$	27.92		28.48	V
	Line regulation	max $I_O$			80	mV
	Load regulation	$V_I = 53$ V, 1-100% of max $I_O$			80	mV
$V_{tr}$	Load transient voltage deviation	$V_I = 53$ V, Load step 25-75-25 % of max $I_O$ , $di/dt = 0.2$ A/ $\mu\text{s}$ ,		$\pm 1000$		mV
$t_{tr}$	Load transient recovery time			40		$\mu\text{s}$
$t_r$	Ramp-up time (from 10-90 % of $V_{Oi}$ )	10-100% of max $I_O$		8		ms
$t_s$	Start-up time (from $V_I$ connection to 90% of $V_{Oi}$ )			12		ms
$I_O$	Output current		0		11	A
$I_{lim}$	Current limit threshold	$T_{ref} < \max T_{ref}$	11.8		16	A
$I_{sc}$	Short circuit current	$T_{ref} = 25^{\circ}\text{C}$			18	A
$V_{Oac}$	Output ripple & noise	See ripple & noise section, max $I_O$ , $V_{Oi}$		70	250	mVp-p
OVP	Over Voltage Protection	$T_{ref} = +25^{\circ}\text{C}$ , $V_I = 53$ V, $I_O = 0$ -100% of max $I_O$	34.7		39.5	V

Note 1: The module can be trimmed down 30% and trimmed up 7% at all temperature condition.

 The module can be trimmed down 40% at  $25^{\circ}\text{C}$  and minimum reference temperature. At least 10% of normal output current is suggested when it is trimmed down 40% at maximum reference temperature. The module can be trimmed up 10% at  $25^{\circ}\text{C}$  and minimum reference temperature. When input voltage below 48V, at most 65% of normal output current is suggested in case it is trimmed up 10% at maximum reference temperature.

 Note 2:  $V_O = < 0.5$  V

**PKJ 4000 RFP series** Direct Converters  
 Input 36-75 V, Output up to 12.4 A / 350 W

EN/LZT 146 367 R3B September 2009

© Ericsson AB

**28.2 V/11 A Typical Characteristics**

**PKJ 4316 PI**

**Efficiency**

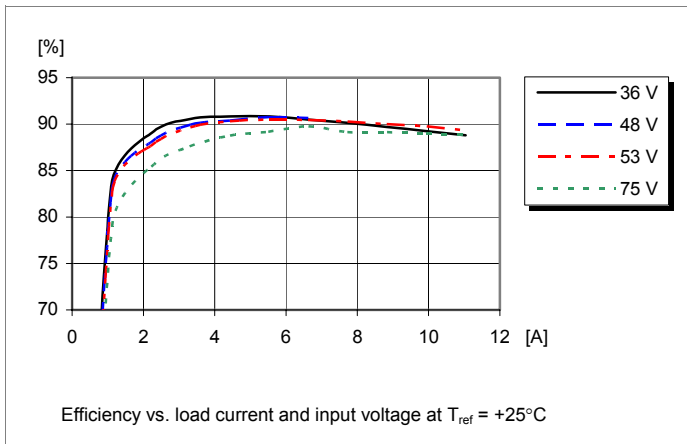

**Power Dissipation**

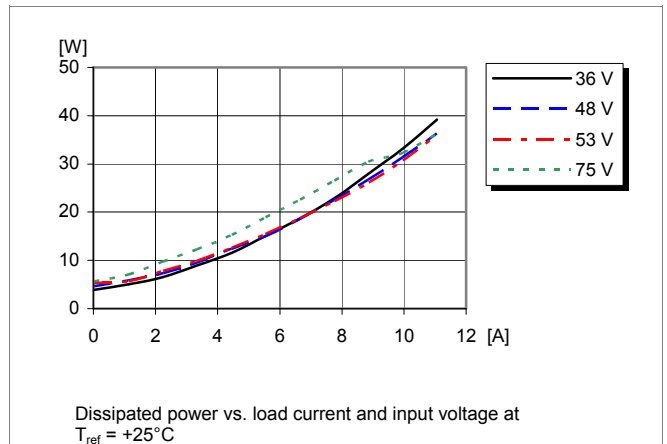

**Output Characteristics**

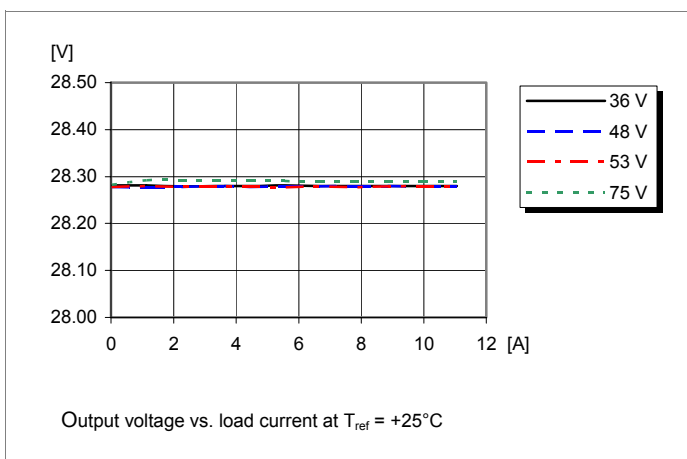

**Current Limit Characteristics**

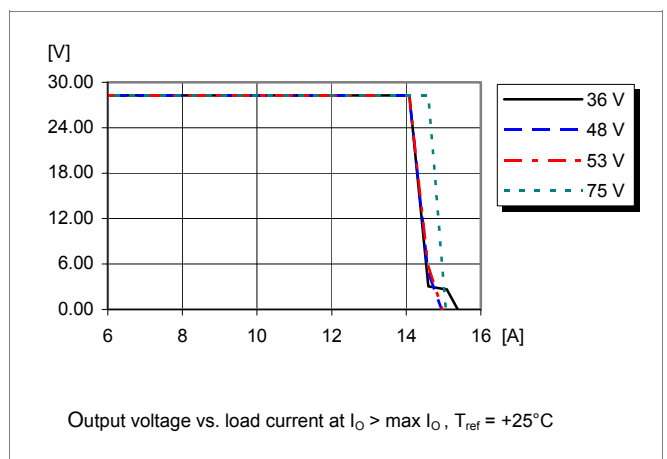

**PKJ 4000 RFPA series** Direct Converters  
 Input 36-75 V, Output up to 12.4 A / 350 W

EN/LZT 146 367 R3B September 2009

© Ericsson AB

**28.2 V/11 A Typical Characteristics**

**PKJ 4316 PI**

**Start-up**

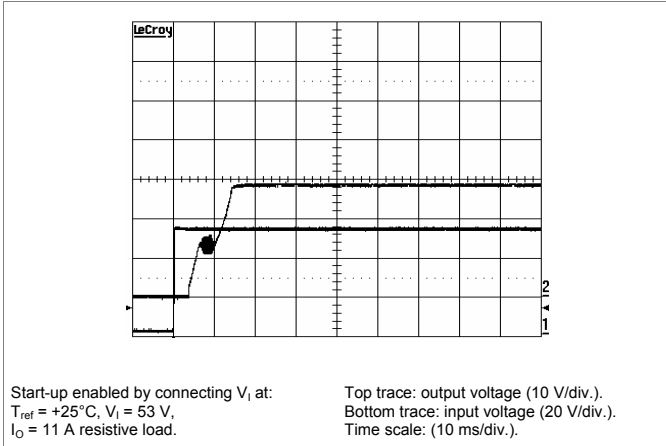

**Shut-down**

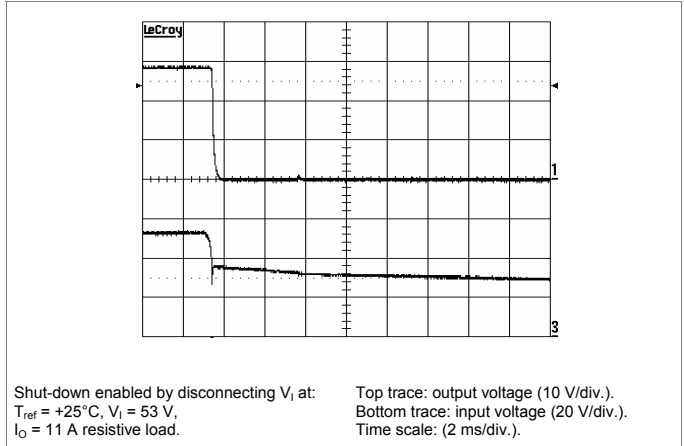

**Output Ripple & Noise**

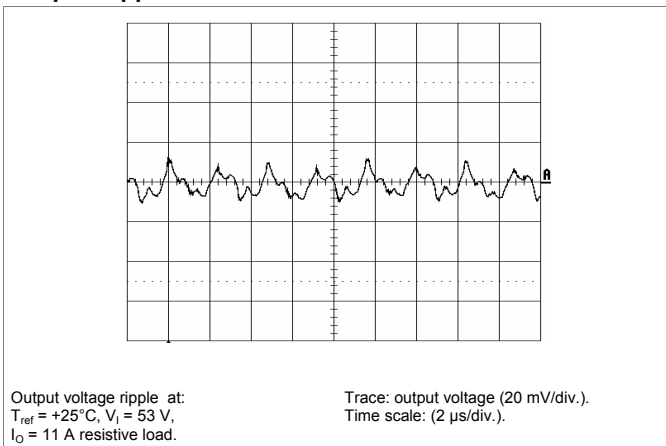

**Output Load Transient Response**

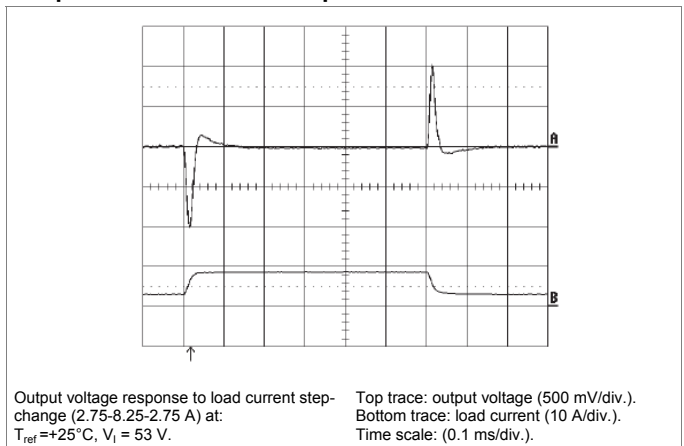

**Output Voltage Adjust (see operating information)**

**Passive adjust**

The resistor value for an adjusted output voltage is calculated by using the following equations:

Output Voltage Adjust Upwards, Increase:

$$R_{adj} = 10 \left[ V_o \frac{(100 + \Delta\%) - 100 + 2 \times \Delta\%}{2.5 \times \Delta\%} - \frac{100 + 2 \times \Delta\%}{\Delta\%} \right] \text{ k}\Omega$$

Output Voltage Adjust Downwards, Decrease:

$$R_{adj} = 10 \left( \frac{100}{\Delta\%} - 2 \right) \text{ k}\Omega$$

Example: Increase 4%  $\Rightarrow V_{out} = 29.33\text{ Vdc}$

$$10 \left[ 28.2 \frac{(100 + 4) - 100 + 2 \times 4}{2.5 \times 4} - \frac{100 + 2 \times 4}{4} \right] \text{ k}\Omega = 2663 \text{ k}\Omega$$

Example: Decrease 2%  $\Rightarrow V_{out} = 27.64\text{ Vdc}$

$$10 \left( \frac{100}{2} - 2 \right) \text{ k}\Omega = 480 \text{ k}\Omega$$

**PKJ 4000 RFP series** Direct Converters  
 Input 36-75 V, Output up to 12.4 A / 350 W

EN/LZT 146 367 R3B September 2009

© Ericsson AB

**28.2 V/11 A Typical Characteristics**

**PKJ 4316 PI**

**Output Current Derating – Base Plate**

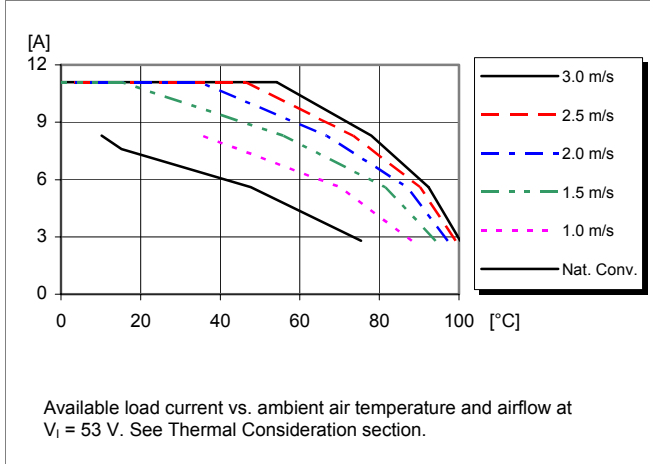

**Thermal Resistance – Base Plate**

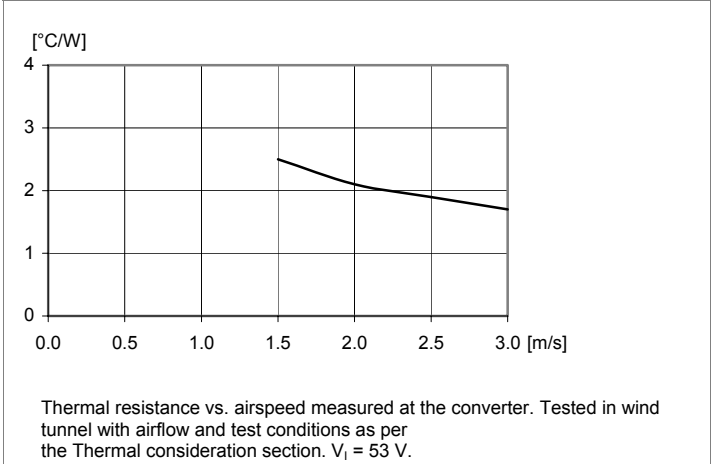

**Output Current Derating – Cold wall sealed box**

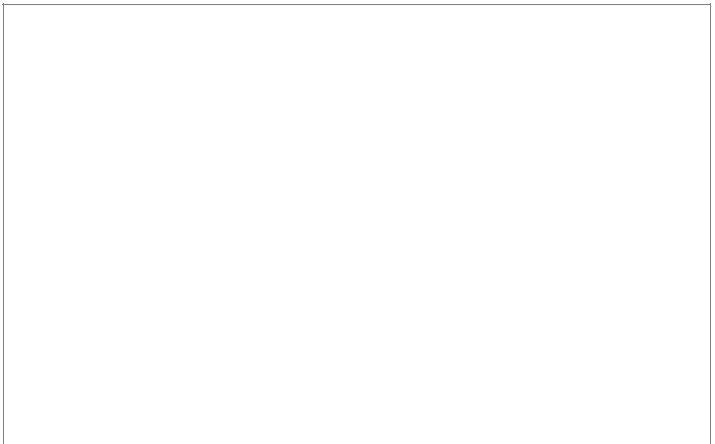
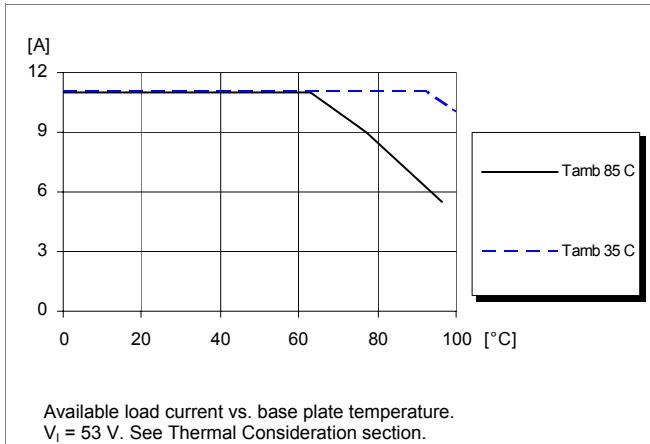



**PKJ 4000 RFPA series** Direct Converters  
 Input 36-75 V, Output up to 12.4 A / 350 W

EN/LZT 146 367 R3B September 2009

© Ericsson AB

**28.2 V/12.4 A Electrical Specification**
**PKJ 4316 API**
 $T_{ref} = -40$  to  $+90^{\circ}\text{C}$ ,  $V_I = 35$  to  $75$  V, unless otherwise specified under Conditions.

 Typical values given at:  $T_{ref} = +25^{\circ}\text{C}$ ,  $V_I = 53$  V, max  $I_O$ , unless otherwise specified under Conditions.

Characteristics		Conditions	min	typ	max	Unit
$V_I$	Input voltage range		35		75	V
$V_{loff}$	Turn-off input voltage	Decreasing input voltage	31	32.2	33	V
$V_{lon}$	Turn-on input voltage	Increasing input voltage	32.5	34	35	V
$C_I$	Internal input capacitance			10		$\mu\text{F}$
$P_O$	Output power	Output voltage initial setting	0		350	W
SVR	Supply voltage rejection (ac)	$f = 100$ Hz sinewave, 1 Vp-p		40		dB
$\eta$	Efficiency	50 % of max $I_O$		91.0		%
		max $I_O$	88	89		
		50 % of max $I_O$ , $V_I = 48$ V		91.0		
		max $I_O$ , $V_I = 48$ V	88	89		
$P_d$	Power Dissipation	max $I_O$ , $T_{ref} = +25^{\circ}\text{C}$		41.0	44.1	W
$P_{li}$	Input idling power	$I_O = 0$ , $V_I = 53$ V		3		W
$P_{RC}$	Input standby power	$V_I = 53$ V (turned off with RC)		150		mW
$f_s$	Switching frequency	0 -100% of max $I_O$	190	210	230	kHz

$V_{Oi}$	Output voltage initial setting and accuracy	$T_{ref} = +25^{\circ}\text{C}$ , $V_I = 53$ V, $I_O = 12.4$ A	27.93	28.2	28.47	V
	Output adjust range	See operation information & see Note 1	19.74		30.17	V
$V_O$	Output voltage tolerance band	10-100% of max $I_O$	27.85		28.55	V
	Idling voltage	$I_O = 0$	27.92		28.48	V
	Line regulation	max $I_O$			80	mV
	Load regulation	$V_I = 53$ V, 0-100% of max $I_O$			80	mV
$V_{tr}$	Load transient voltage deviation	$V_I = 53$ V, Load step 25-75-25 % of max $I_O$ , $di/dt = 0.2$ A/ $\mu\text{s}$ ,		$\pm 1000$		mV
$t_{tr}$	Load transient recovery time			40		$\mu\text{s}$
$t_r$	Ramp-up time (from 10-90 % of $V_{Oi}$ )			10		ms
$t_s$	Start-up time (from $V_I$ connection to 90% of $V_{Oi}$ )	10-100% of max $I_O$		13		ms
$I_O$	Output current		0		12.4	A
$I_{lim}$	Current limit threshold	$T_{ref} < \text{max } T_{ref}$	13		19.5	A
$I_{sc}$	Short circuit current	$T_{ref} = 25^{\circ}\text{C}$ , see Note 2			20.5	A
$V_{Oac}$	Output ripple & noise	See ripple & noise section, max $I_O$ , $V_{Oi}$		70	250	mVp-p
OVP	Over Voltage Protection	$T_{ref} = +25^{\circ}\text{C}$ , $V_I = 53$ V, $I_O = 0$ -100% of max $I_O$	34.7		39.5	V

Note 1: The module can be trimmed down 30% and trimmed up 7% at all temperature condition.

 The module can be trimmed down 40% at  $25^{\circ}\text{C}$  and minimum reference temperature. At least 10% of normal output current is suggested when it is trimmed down 40% at maximum reference temperature. The module can be trimmed up 10% at  $25^{\circ}\text{C}$  and minimum reference temperature. When input voltage below 48V, at most 65% of normal output current is suggested in case it is trimmed up 10% at maximum reference temperature.

 Note 2:  $V_O = < 0.5$  V

**PKJ 4000 RFPA series** Direct Converters  
 Input 36-75 V, Output up to 12.4 A / 350 W

EN/LZT 146 367 R3B September 2009

© Ericsson AB

**28.2 V/12.4 A Typical Characteristics**

**PKJ 4316 API**

**Efficiency**

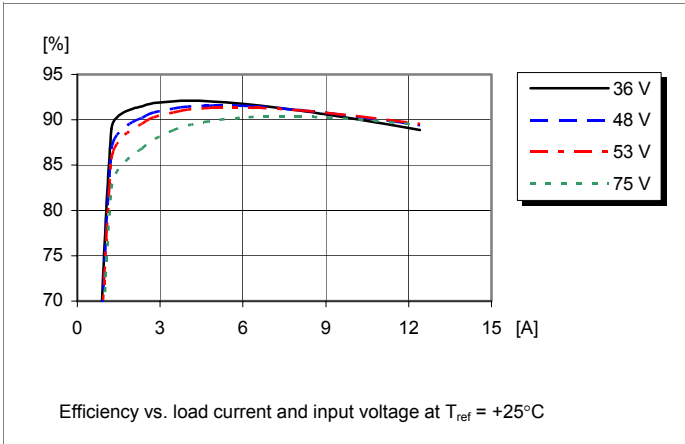

**Power Dissipation**

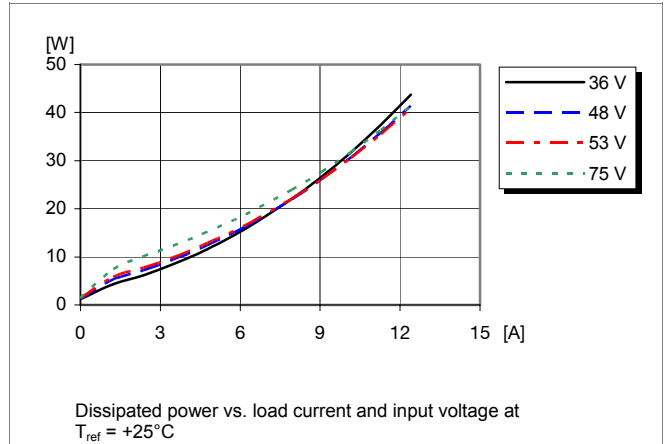

**Output Characteristics**

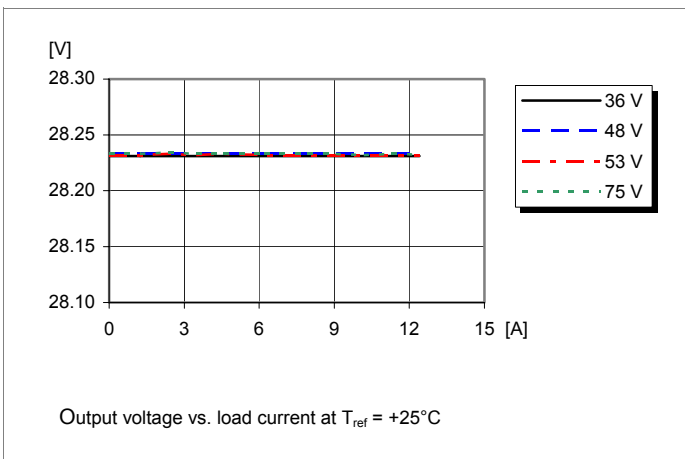

**Current Limit Characteristics**

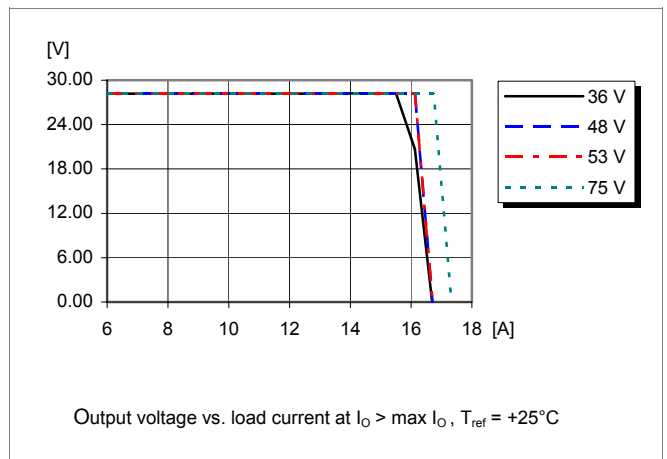

**PKJ 4000 RFPA series** Direct Converters  
Input 36-75 V, Output up to 12.4 A / 350 W

EN/LZT 146 367 R3B September 2009

© Ericsson AB

**28.2 V/12.4 A Typical Characteristics**

**PKJ 4316 API**

**Start-up**

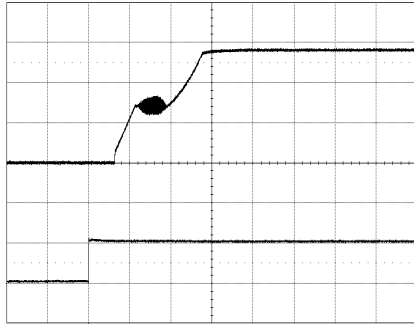

Start-up enabled by connecting  $V_1$  at:  
 $T_{ref} = +25^{\circ}\text{C}$ ,  $V_1 = 53\text{ V}$ ,  
 $I_o = 12.4\text{ A}$  resistive load.

Top trace: output voltage (10 V/div.).  
Bottom trace: input voltage (50 V/div.).  
Time scale: (5 ms/div.).

**Shut-down**

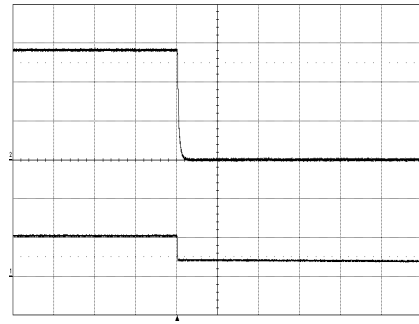

Shut-down enabled by disconnecting  $V_1$  at:  
 $T_{ref} = +25^{\circ}\text{C}$ ,  $V_1 = 53\text{ V}$ ,  
 $I_o = 12.4\text{ A}$  resistive load.

Top trace: output voltage (10 V/div.).  
Bottom trace: input voltage (50 V/div.).  
Time scale: (5 ms/div.).

**Output Ripple & Noise**

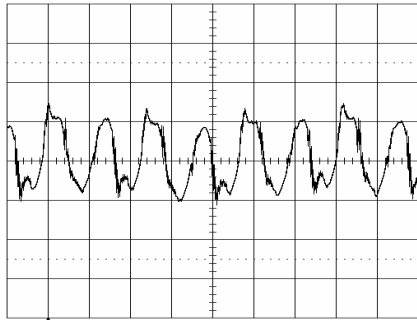

Output voltage ripple at:  
 $T_{ref} = +25^{\circ}\text{C}$ ,  $V_1 = 53\text{ V}$ ,  
 $I_o = 12.4\text{ A}$  resistive load.

Trace: output voltage (20 mV/div.).  
Time scale: (2  $\mu\text{s}$ /div.).

**Output Load Transient Response**

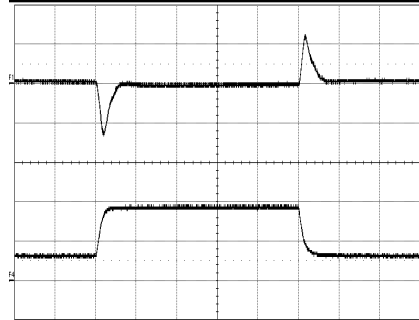

Output voltage response to load current step-change (3.1-9.3-3.1 A) at:  
 $T_{ref} = +25^{\circ}\text{C}$ ,  $V_1 = 53\text{ V}$ .

Top trace: output voltage (1 V/div.).  
Bottom trace: load current (5 A/div.).  
Time scale: (0.1 ms/div.).

**Output Voltage Adjust (see operating information)**

**Passive adjust**

The resistor value for an adjusted output voltage is calculated by using the following equations:

Output Voltage Adjust Upwards, Increase:

$$R_{adj} = 10 \left[ V_o \frac{(100 + \Delta\%) - 100 + 2 \times \Delta\%}{2.5 \times \Delta\%} \frac{100 + 2 \times \Delta\%}{\Delta\%} \right] \text{ k}\Omega$$

Output Voltage Adjust Downwards, Decrease:

$$R_{adj} = 10 \left( \frac{100}{\Delta\%} - 2 \right) \text{ k}\Omega$$

Example: Increase 4%  $\Rightarrow V_{out} = 29.33\text{ Vdc}$

$$10 \left[ 28.2 \frac{(100 + 4) - 100 + 2 \times 4}{2.5 \times 4} \frac{100 + 2 \times 4}{4} \right] \text{ k}\Omega = 2663 \text{ k}\Omega$$

Example: Decrease 2%  $\Rightarrow V_{out} = 27.64\text{ Vdc}$

$$10 \left( \frac{100}{2} - 2 \right) \text{ k}\Omega = 480 \text{ k}\Omega$$

**Active adjust**

The output voltage may be adjusted using a voltage applied to the Vadj pin. This voltage is calculated by using the following equations:

$$V_{adj} = \left( 2.5 + 5 \times \frac{V_{desired} - V_o}{V_o} \right) \text{ V}$$

Example: Upwards  $\Rightarrow 29.33\text{V}$

$$\left( 2.5 + 5 \times \frac{29.33 - 28.2}{28.2} \right) = 2.7\text{V}$$

Example: Downwards  $\Rightarrow 27.07\text{V}$

$$\left( 2.5 + 5 \times \frac{27.07 - 28.2}{28.2} \right) = 2.3\text{V}$$

**PKJ 4000 RFA series** Direct Converters  
 Input 36-75 V, Output up to 12.4 A / 350 W

EN/LZT 146 367 R3B September 2009

© Ericsson AB

**28.2 V/12.4 A Typical Characteristics**

**PKJ 4316 API**

**Output Current Derating – Base Plate**

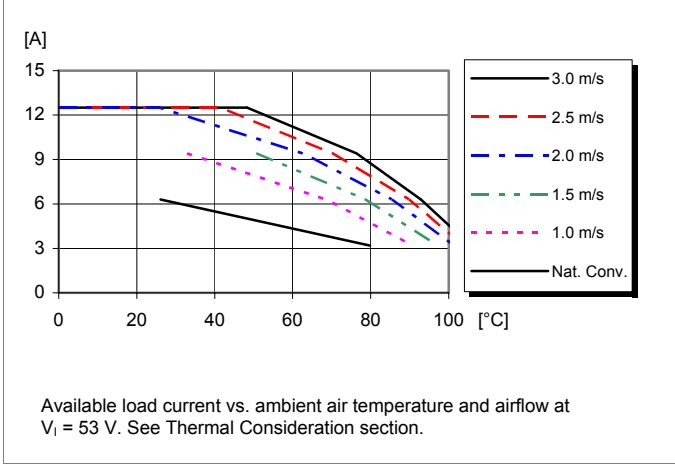

**Thermal Resistance – Base Plate**

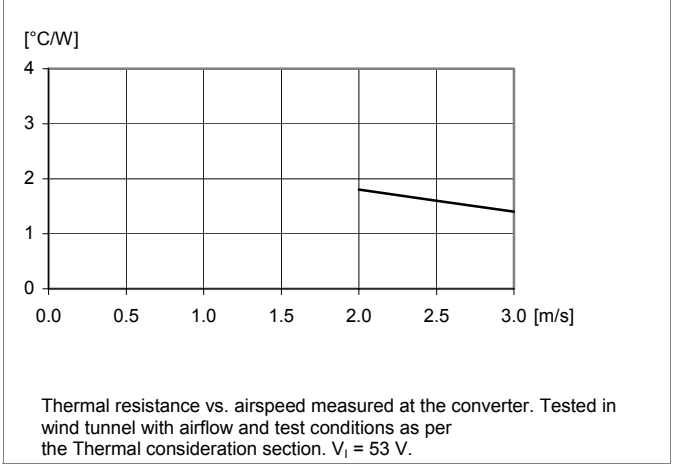

**Output Current Derating – Cold wall sealed box**

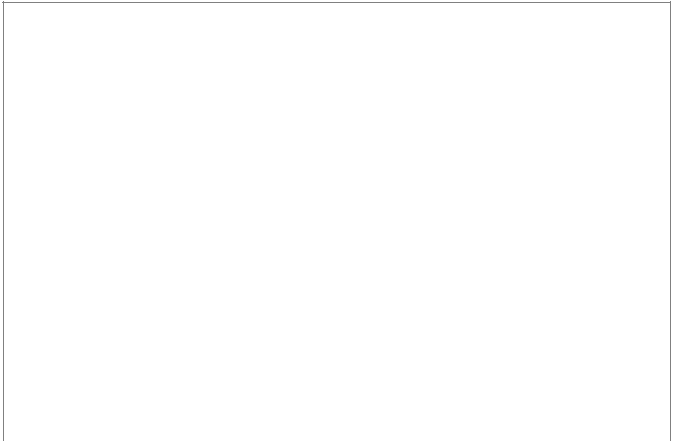
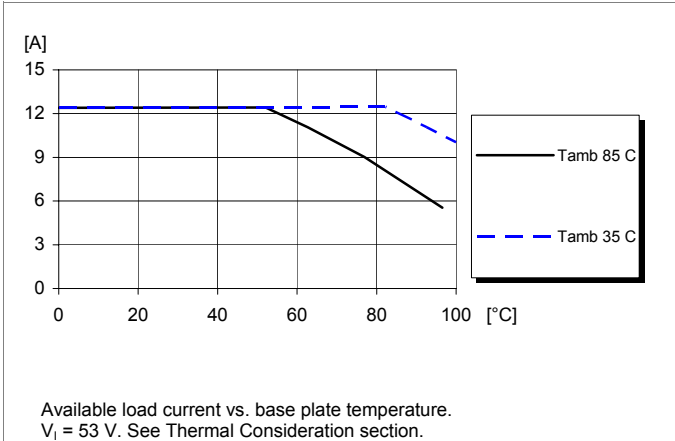

**PKJ 4000 RFPA series Direct Converters**  
 Input 36-75 V, Output up to 12.4 A / 350 W

EN/LZT 146 367 R3B September 2009

© Ericsson AB

**30.2 V/8.3 A Electrical Specification**
**PKJ 4216N PI**
 $T_{ref} = -40$  to  $+90^{\circ}\text{C}$ ,  $V_I = 35$  to  $75$  V, unless otherwise specified under Conditions.

 Typical values given at:  $T_{ref} = +25^{\circ}\text{C}$ ,  $V_I = 53$  V, max  $I_O$ , unless otherwise specified under Conditions.

Characteristics		Conditions	min	typ	max	Unit
$V_I$	Input voltage range		35		75	V
$V_{loff}$	Turn-off input voltage	Decreasing input voltage	30	33.5	35	V
$V_{lon}$	Turn-on input voltage	Increasing input voltage	32	34.5	36	V
$C_I$	Internal input capacitance			10		$\mu\text{F}$
$P_O$	Output power	Output voltage initial setting	0		250	W
SVR	Supply voltage rejection (ac)	$f = 100$ Hz sinewave, 1 Vp-p		40		dB
$\eta$	Efficiency	50 % of max $I_O$		91.5		%
		max $I_O$	90.5	91.0		
		50 % of max $I_O$ , $V_I = 48$ V		91.5		
		max $I_O$ , $V_I = 48$ V	90.5	91.0		
$P_d$	Power Dissipation	max $I_O$ , $T_{ref} = +25^{\circ}\text{C}$		24.7	26.2	W
$P_{li}$	Input idling power	$I_O = 0$ , $V_I = 53$ V		3		W
$P_{RC}$	Input standby power	$V_I = 53$ V (turned off with RC)		150		mW
$f_s$	Switching frequency	0 -100% of max $I_O$	190	210	230	kHz

$V_{O_i}$	Output voltage initial setting and accuracy	$T_{ref} = +25^{\circ}\text{C}$ , $V_I = 53$ V, $I_O = 8.3$ A	29.95	30.2	30.45	V
	Output adjust range	See operation information & see Note 1	21.14		30.95	V
$V_O$	Output voltage tolerance band	10-100% of max $I_O$	29.90		30.50	V
	Idling voltage	$I_O = 0$	29.90		30.50	V
	Line regulation	max $I_O$			100	mV
	Load regulation	$V_I = 53$ V, 1-100% of max $I_O$			100	mV
$V_{tr}$	Load transient voltage deviation	$V_I = 53$ V, Load step 25-75-25 % of max $I_O$ , $di/dt = 1$ A/ $\mu\text{s}$ ,		$\pm 1000$		mV
$t_{tr}$	Load transient recovery time			40		$\mu\text{s}$
$t_r$	Ramp-up time (from 10-90 % of $V_{O_i}$ )			8		ms
$t_s$	Start-up time (from $V_I$ connection to 90% of $V_{O_i}$ )	10-100% of max $I_O$		12		ms
$I_O$	Output current		0		8.3	A
$I_{lim}$	Current limit threshold	$T_{ref} < \max T_{ref}$	8.7		14.2	A
$I_{sc}$	Short circuit current	$T_{ref} = 25^{\circ}\text{C}$ , see Note 2			15.8	A
$V_{Oac}$	Output ripple & noise	See ripple & noise section, max $I_O$ , $V_{O_i}$		200	250	mVp-p
OVP	Over Voltage Protection	$T_{ref} = +25^{\circ}\text{C}$ , $V_I = 53$ V, $I_O = 0$ -100% of max $I_O$	34		40	V

Note 1: The module can be trimmed down 30% and trimmed up 2.5% at all temperature condition.

 The module can be trimmed down 40% at  $25^{\circ}\text{C}$  and minimum reference temperature. At least 10% of normal output current is suggested when it is trimmed down 40% at maximum reference temperature. At most 10% of normal output current is suggested when it is trimmed up 10% at all temperature condition.

 Note 2:  $V_O = < 0.5$  V

**PKJ 4000 RFPA series** Direct Converters  
 Input 36-75 V, Output up to 12.4 A / 350 W

EN/LZT 146 367 R3B September 2009

© Ericsson AB

**30.2 V/8.3 A Typical Characteristics**

**PKJ 4216N PI**

**Efficiency**

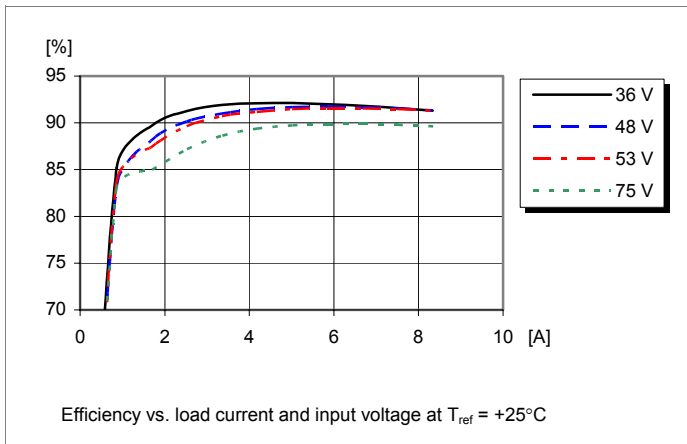

**Power Dissipation**

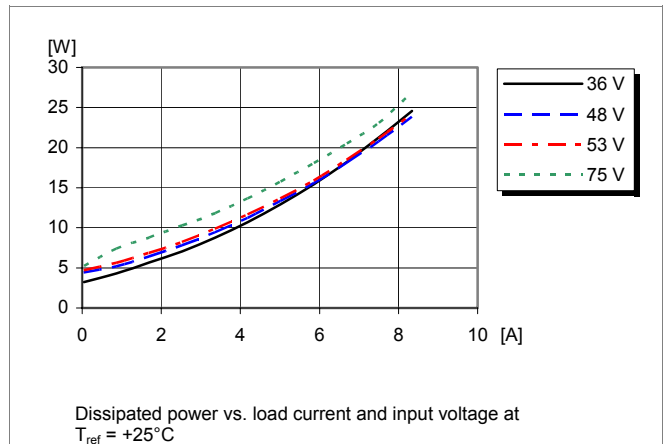

**Output Characteristics**

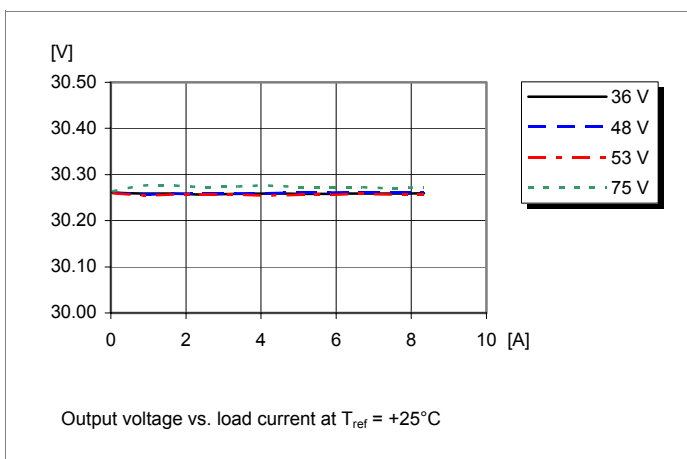

**Current Limit Characteristics**

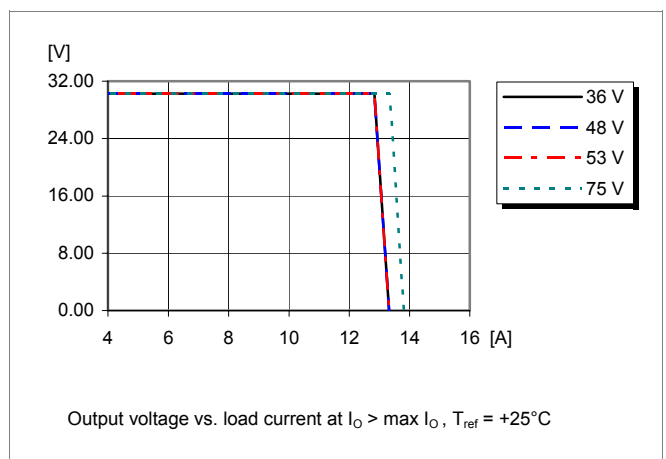

**PKJ 4000 RFPA series** Direct Converters  
 Input 36-75 V, Output up to 12.4 A / 350 W

EN/LZT 146 367 R3B September 2009  
 © Ericsson AB

**30.2 V/8.3 A Typical Characteristics**

**PKJ 4216N PI**

**Start-up**

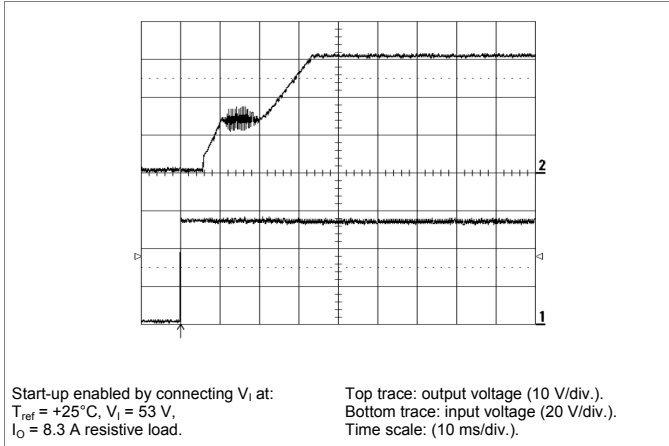

**Shut-down**

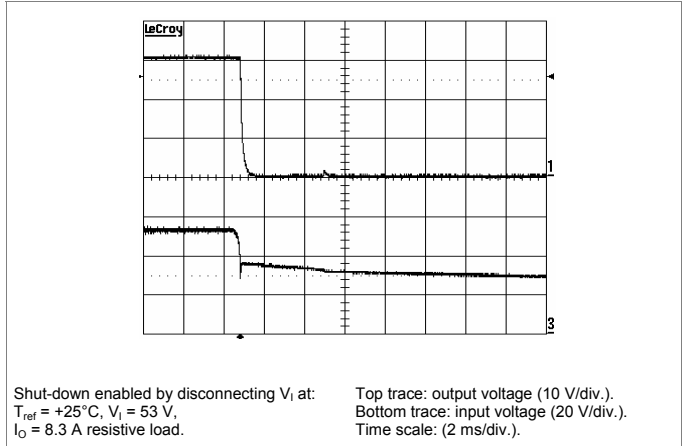

**Output Ripple & Noise**

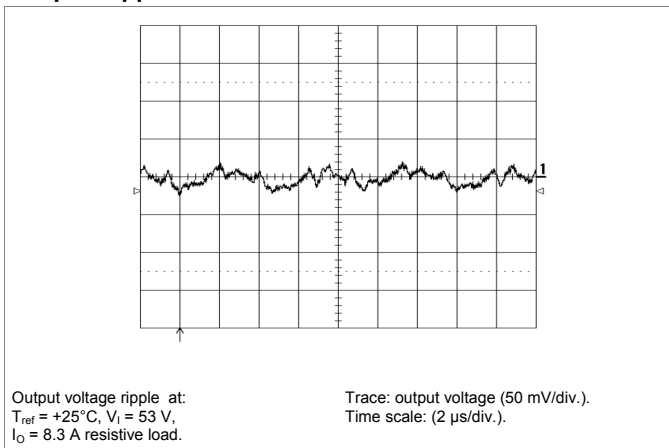

**Output Load Transient Response**

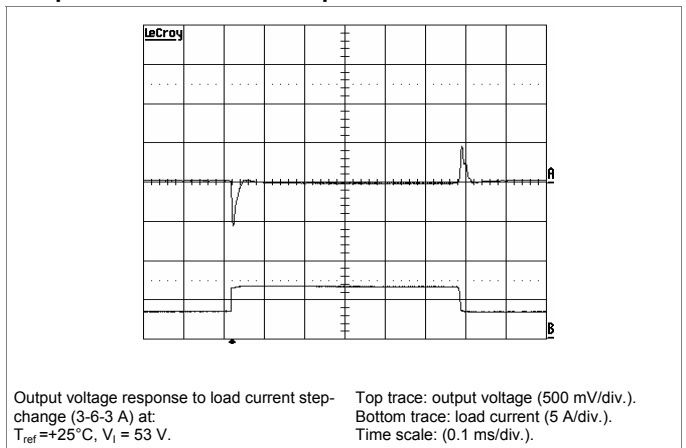

**Output Voltage Adjust (see operating information)**

**Passive adjust**

The resistor value for an adjusted output voltage is calculated by using the following equations:

Output Voltage Adjust Upwards, Increase:

$$R_{adj} = 10 \left[ V_o \frac{(100 + \Delta\%) - 100 + 2 \times \Delta\%}{2.5 \times \Delta\%} - \frac{100 + 2 \times \Delta\%}{\Delta\%} \right] \text{ k}\Omega$$

Output Voltage Adjust Downwards, Decrease:

$$R_{adj} = 10 \left( \frac{100}{\Delta\%} - 2 \right) \text{ k}\Omega$$

Example: Increase 4%  $\Rightarrow V_{out} = 31.41\text{ Vdc}$

$$10 \left[ 30.2 \frac{(100 + 4) - 100 + 2 \times 4}{2.5 \times 4} - \frac{100 + 2 \times 4}{4} \right] \text{ k}\Omega = 2871 \text{ k}\Omega$$

Example: Decrease 2%  $\Rightarrow V_{out} = 29.60\text{ Vdc}$

$$10 \left( \frac{100}{2} - 2 \right) \text{ k}\Omega = 480 \text{ k}\Omega$$

**PKJ 4000 RFPA series** Direct Converters  
 Input 36-75 V, Output up to 12.4 A / 350 W

EN/LZT 146 367 R3B September 2009

© Ericsson AB

**30.2 V/8.3 A Typical Characteristics**

**PKJ 4216N PI**

**Output Current Derating – Base Plate**

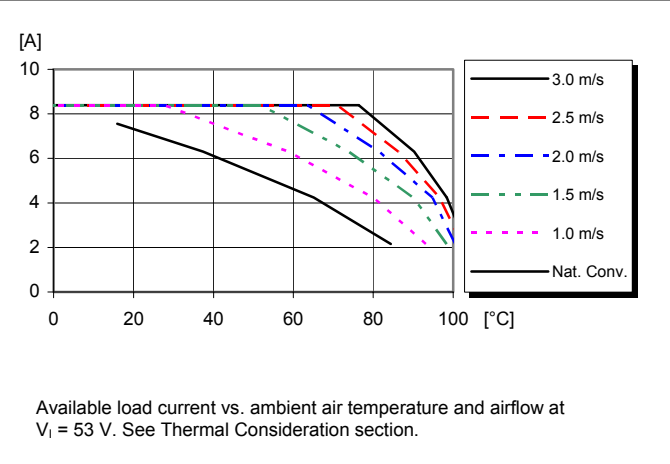

**Thermal Resistance – Base Plate**

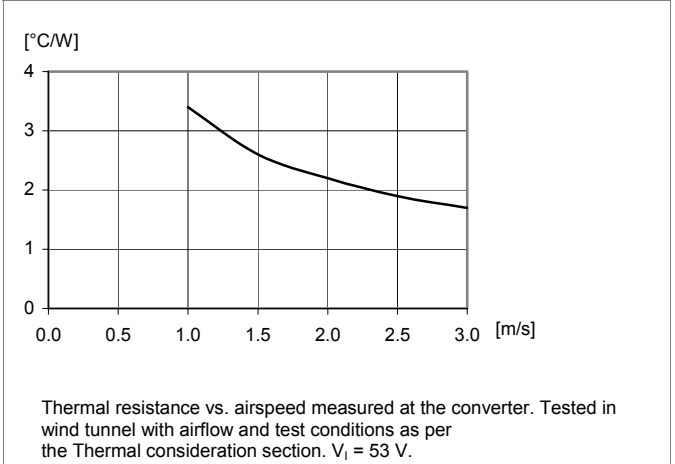

**Output Current Derating – Cold wall sealed box**

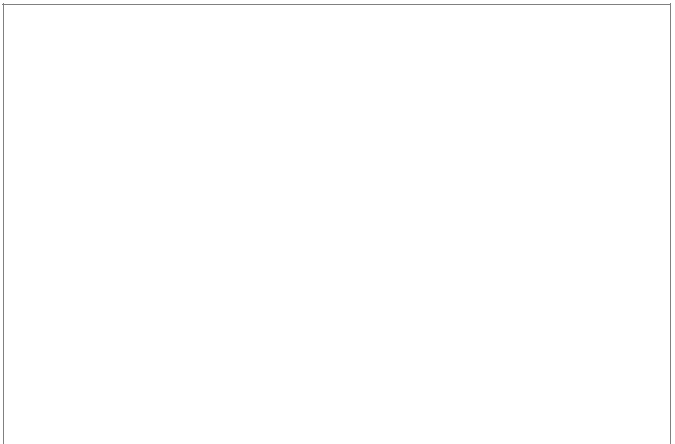
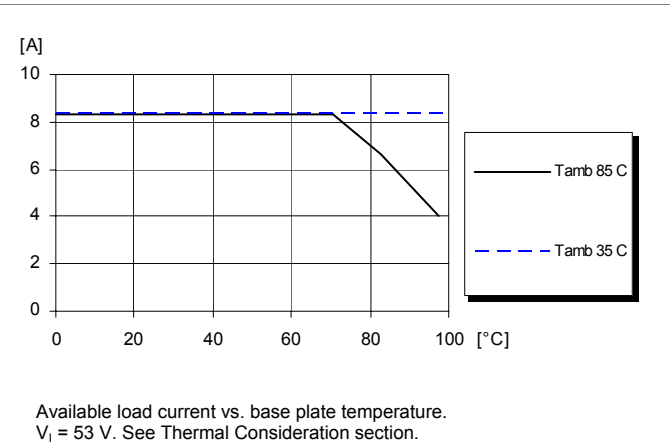



**PKJ 4000 RFPA series Direct Converters**  
 Input 36-75 V, Output up to 12.4 A / 350 W

EN/LZT 146 367 R3B September 2009

© Ericsson AB

**28.2 V, 8.3 A/234W Electrical Specification**
**PKJ 4216 PI**
 $T_{ref} = -40$  to  $+90^{\circ}\text{C}$ ,  $V_I = 35$  to  $75$  V, sense pins connected to output pins unless otherwise specified under Conditions.

 Typical values given at:  $T_{ref} = +25^{\circ}\text{C}$ ,  $V_I = 53$  V,  $I_O = \text{max } I_O$ , unless otherwise specified under Conditions.

Characteristics		Conditions	min	typ	max	Unit
$V_I$	Input voltage range		35		75	V
$V_{loff}$	Turn-off input voltage	Decreasing input voltage	30	32.5	35	V
$V_{lon}$	Turn-on input voltage	Increasing input voltage	32	34.5	36	V
$C_I$	Internal input capacitance			10		$\mu\text{F}$
$P_O$	Output power	Output voltage initial setting	0		234	W
$\eta$	Efficiency	50 % of max $I_O$		91.4		%
		max $I_O$		90.8		
		50 % of max $I_O$ , $V_I = 48$ V		91.5		
		max $I_O$ , $V_I = 48$ V		90.8		
$P_d$	Power Dissipation	max $I_O$		23.7	27.5	W
$P_{li}$	Input idling power	$I_O = 0$ A, $V_I = 53$ V		2		W
$P_{RC}$	Input standby power	$V_I = 53$ V (turned off with RC)		0.20		W
$f_s$	Switching frequency	0-100 % of max $I_O$	190	210	230	kHz

$V_{Oi}$	Output voltage initial setting and accuracy	$T_{ref} = +25^{\circ}\text{C}$ , $V_I = 53$ V, $I_O = 8.3$ A	27.92	28.20	28.48	V
$V_O$	Output adjust range	See operating information	19.74		31.02	V
	Output voltage tolerance band	10-100 % of max $I_O$	27.64		28.76	V
	Idling voltage	$I_O = 0$ A	27.64		28.76	V
	Line regulation	max $I_O$		10	50	mV
	Load regulation	$V_I = 53$ V, 0-100 % of max $I_O$		10	50	mV
$V_{tr}$	Load transient voltage deviation	$V_I = 53$ V, Load step 25-75-25 % of max $I_O$ , $di/dt = 0.2$ A/ $\mu\text{s}$		$\pm 1200$	$\pm 1800$	mV
$t_{tr}$	Load transient recovery time			40	100	$\mu\text{s}$
$t_r$	Ramp-up time (from 10-90 % of $V_{Oi}$ )	10-100 % of max $I_O$	3	8	15	ms
$t_s$	Start-up time (from $V_I$ connection to 90 % of $V_{Oi}$ )		6	12	20	ms
$t_f$	$V_I$ shut-down fall time (from $V_I$ off to 10 % of $V_O$ )	max $I_O$	0.1	0.2	0.4	ms
		$I_O = 0$ A	0.2	0.4	0.8	s
$t_{RC}$	RC start-up time	max $I_O$		13		ms
	RC shut-down fall time (from RC off to 10 % of $V_O$ )	max $I_O$		0.4		ms
		$I_O = 0$ A		0.4		s
$I_O$	Output current		0		8.3	A
$I_{lim}$	Current limit threshold	$T_{ref} < \text{max } T_{ref}$	9.5	12	16	A
$I_{sc}$	Short circuit current	$T_{ref} = 25^{\circ}\text{C}$ , see Note 1		13	17	A
$V_{Oac}$	Output ripple & noise	See ripple & noise section, max $I_O$ , $V_{Oi}$		50	250	mVp-p
OVP	Over voltage protection	$T_{ref} = +25^{\circ}\text{C}$ , $V_I = 53$ V, 0-100 % of max $I_O$	35	37	39	V

Note 1: The module can be trimmed down 30% and trimmed up 10% at all temperature condition.

 The module can be trimmed down 40% at  $25^{\circ}\text{C}$  and minimum reference temperature. At least 10% of normal output current is suggested when it is trimmed down 40% at maximum reference temperature.

 Note 2:  $V_O = < 0.5$  V

**PKJ 4000 RFPA series** Direct Converters  
 Input 36-75 V, Output up to 12.4 A / 350 W

EN/LZT 146 367 R3B September 2009

© Ericsson AB

**28.2 V, 8.3 A/234W Typical Characteristics**

**PKJ 4216 PI**

**Efficiency**

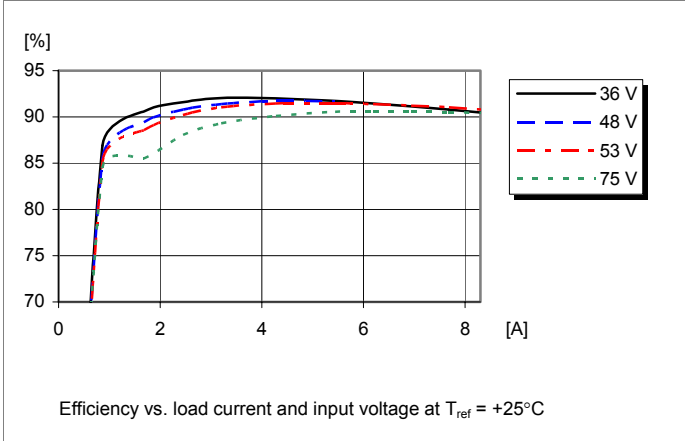

**Power Dissipation**

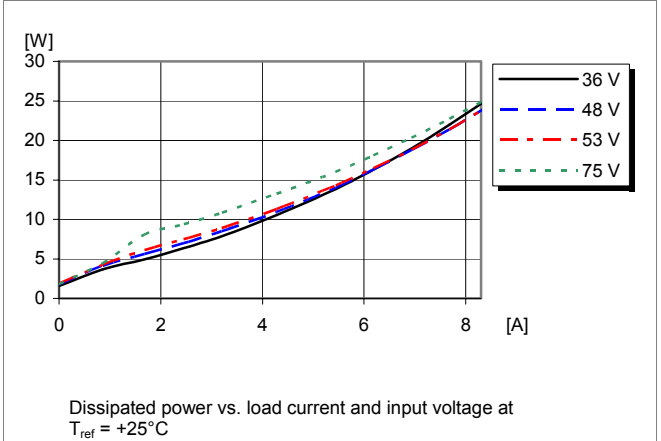

**Output Characteristics**

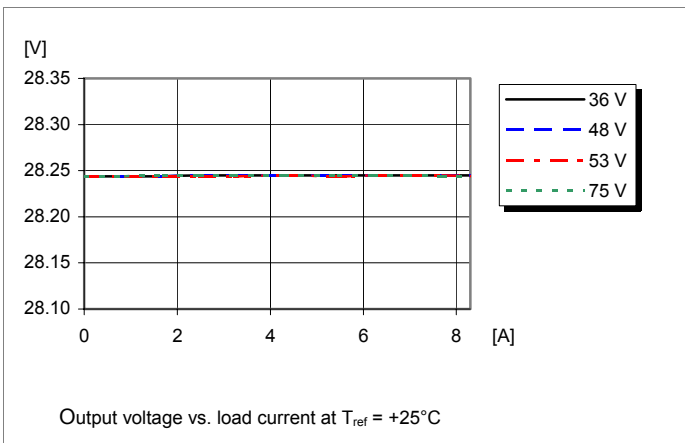

**Current Limit Characteristics**

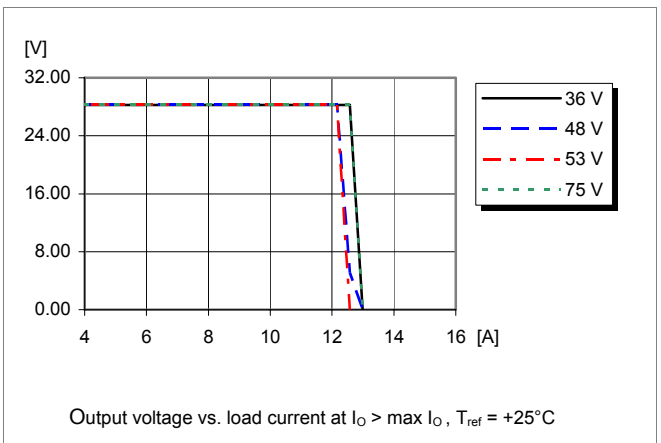

**PKJ 4000 RFA series** Direct Converters  
Input 36-75 V, Output up to 12.4 A / 350 W

EN/LZT 146 367 R3B September 2009

© Ericsson AB

**28.2 V, 8.3 A/234W Typical Characteristics**

**PKJ 4216 PI**

**Start-up**

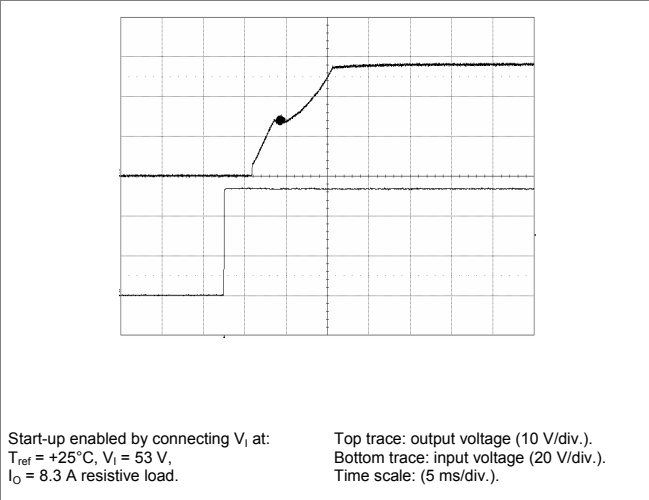

**Shut-down**

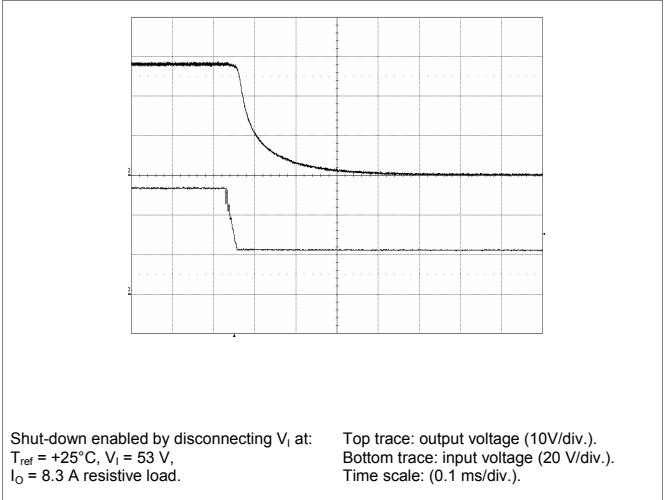

**Output Ripple & Noise**

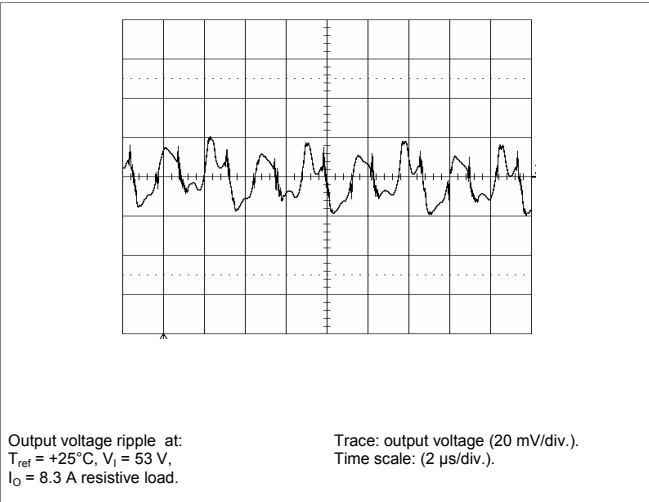

**Output Load Transient Response**

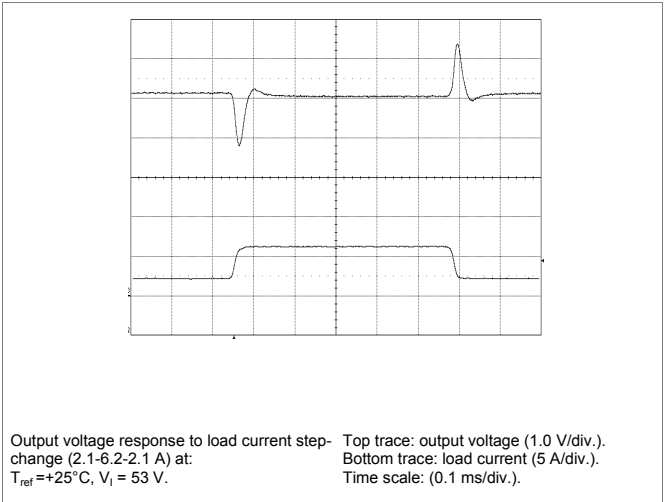

**Output Voltage Adjust (see operating information)**

**Passive adjust**

The resistor value for an adjusted output voltage is calculated by using the following equations:

Output Voltage Adjust Upwards, Increase:

$$R_{adj} = 10 \left[ V_o \frac{(100 + \Delta\%) - 100 + 2 \times \Delta\%}{2.5 \times \Delta\%} - \frac{100 + 2 \times \Delta\%}{\Delta\%} \right] \text{ k}\Omega$$

Output Voltage Adjust Downwards, Decrease:

$$R_{adj} = 10 \left( \frac{100}{\Delta\%} - 2 \right) \text{ k}\Omega$$

Example: Increase 4%  $\Rightarrow V_{out} = 29.33\text{ Vdc}$

$$10 \left[ 28.2 \frac{(100 + 4) - 100 + 2 \times 4}{2.5 \times 4} - \frac{100 + 2 \times 4}{4} \right] \text{ k}\Omega = 2663 \text{ k}\Omega$$

Example: Decrease 2%  $\Rightarrow V_{out} = 27.64\text{ Vdc}$

$$10 \left( \frac{100}{2} - 2 \right) \text{ k}\Omega = 480 \text{ k}\Omega$$

**PKJ 4000 RFP series** Direct Converters  
 Input 36-75 V, Output up to 12.4 A / 350 W

EN/LZT 146 367 R3B September 2009

© Ericsson AB

**28.2 V, 8.3 A/234W Typical Characteristics**

**PKJ 4216 PI**

**Output Current Derating – Base Plate**

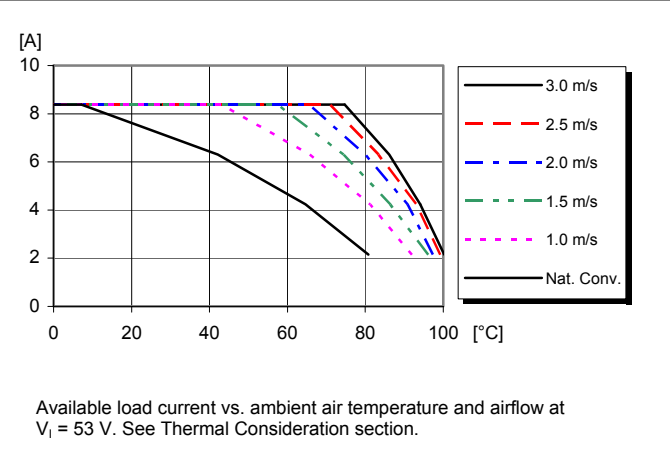

**Thermal Resistance – Base Plate**

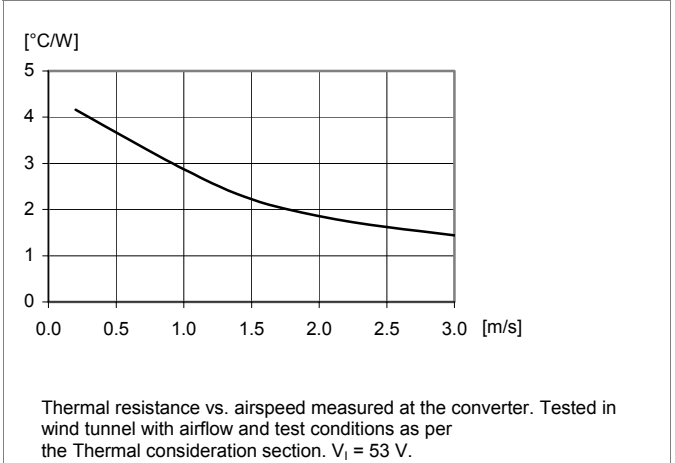

**Output Current Derating – Cold wall sealed box**

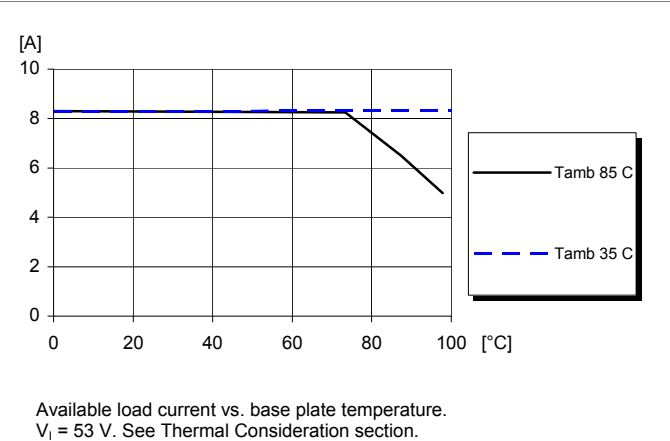

**PKJ 4000 RFPA series Direct Converters**  
 Input 36-75 V, Output up to 12.4 A / 350 W

EN/LZT 146 367 R3B September 2009

© Ericsson AB

**EMC Specification**

Conducted EMI measured according to EN55022, CISPR 22 and FCC part 15J (see test set-up). See Design Note 009 for further information. The fundamental switching frequency is 210 kHz for PKJ 4316 API @  $V_1 = 53$  V, max  $I_O$ .

**Conducted EMI Input terminal value (typ)**

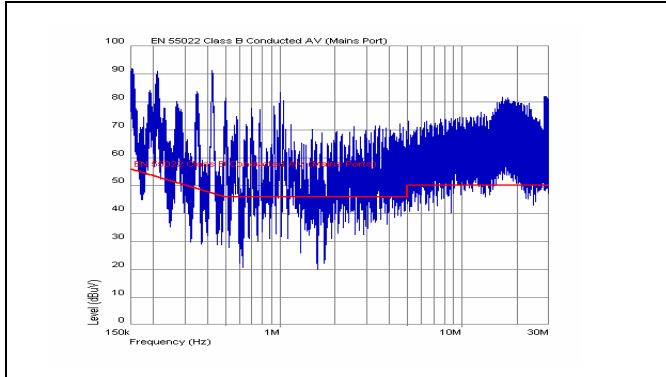

EMI without filter

**External filter (class B)**

Required external input filter in order to meet class B in EN 55022, CISPR 22 and FCC part 15J.

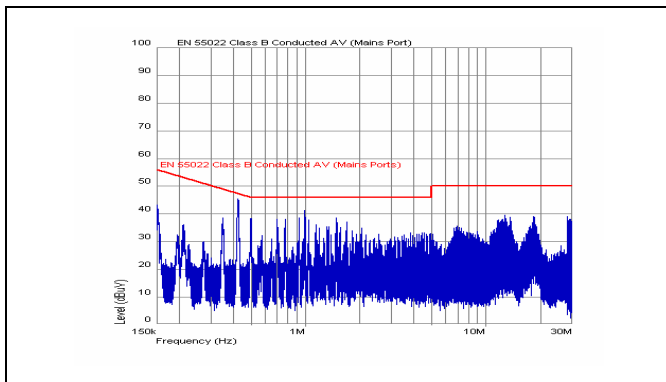
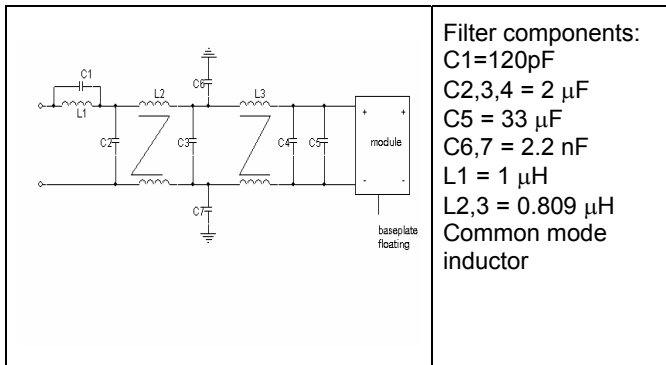

EMI with filter

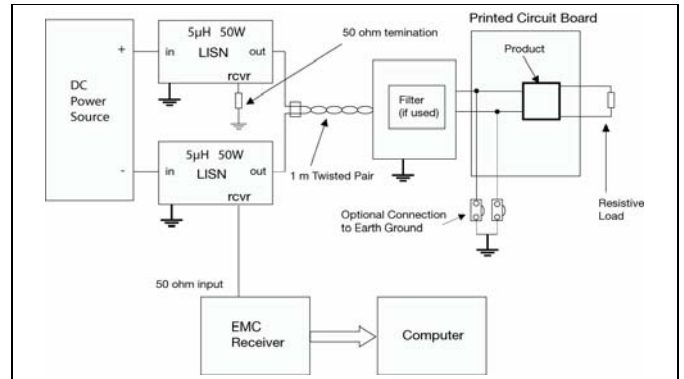

Test set-up

**Layout recommendations**

The radiated EMI performance of the Product will depend on the PCB layout and ground layer design. It is also important to consider the stand-off of the product. If a ground layer is used, it should be connected to the output of the product and the equipment ground or chassis.

A ground layer will increase the stray capacitance in the PCB and improve the high frequency EMC performance.

**Output ripple and noise**

Output ripple and noise measured according to figure below. See Design Note 022 for detailed information.

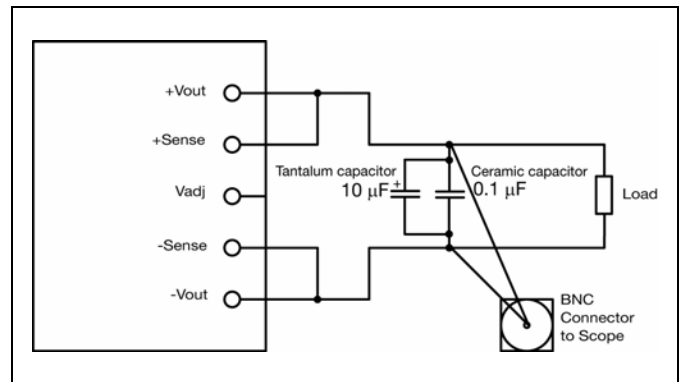

Output ripple and noise test setup

**PKJ 4000 RFPA series** Direct Converters  
Input 36-75 V, Output up to 12.4 A / 350 W

EN/LZT 146 367 R3B September 2009

© Ericsson AB

**Operating information**

**Input Voltage**

The input voltage range 35 to 75Vdc meets the requirements of the European Telecom Standard ETS 300 132-2 for normal input voltage range in -48 and -60 Vdc systems, -40.5 to -57.0 V and -50.0 to -72 V respectively. At input voltages exceeding 75 V, the power loss will be higher than at normal input voltage and Tref must be limited to absolute max +120°C. The absolute maximum continuous input voltage is 80 Vdc.

**Turn-off Input Voltage**

The DC/DC converters monitor the input voltage and will turn on and turn off at predetermined levels. The minimum hysteresis between turn on and turn off input voltage is 1V.

**Remote Control (RC)**

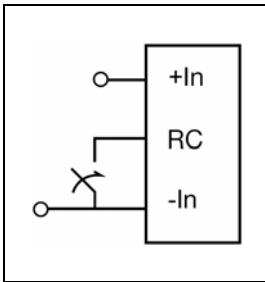

The products are fitted with a remote control function referenced to the primary negative input connection (- In), with negative and positive logic options available. The RC function allows the product to be turned on/off by an external device like a semiconductor or mechanical switch. The RC pin has an internal pull up resistor to + In.

The maximum required sink current is 1 mA. When the RC pin is left open, the voltage generated on the RC pin is 3.5 – 6.0 V. The standard product is provided with “negative logic” remote control and will be off until the RC pin is connected to the -In. To turn on the product the voltage between RC pin and -In should be less than 1V. To turn off the converter the RC pin should be left open, or connected to a voltage higher than 4 V referenced to -In. In situations where it is desired to have the product to power up automatically without the need for control signals or a switch, the RC pin can be wired directly to -In.

See Design Note 021 for detailed information.

**Input and Output Impedance**

The impedance of both the input source and the load will interact with the impedance of the product. It is important that the input source has low characteristic impedance. The products are designed for stable operation without external capacitors connected to the input or output. The performance in some applications can be enhanced by addition of external capacitance as described under External Decoupling Capacitors.

If the input voltage source contains significant inductance, the addition of a 22 - 100 µF capacitor across the input of the product will ensure stable operation. The capacitor is not required when powering the product from an input source with an inductance below 10 µH. The minimum required capacitance value depends on the output power and the input

voltage. The higher output power the higher input capacitance is needed. Approximately doubled capacitance value is required for a 24 V input voltage source compared to a 48V input voltage source.

**External Decoupling Capacitors**

When powering loads with significant dynamic current requirements, the voltage regulation at the point of load can be improved by addition of decoupling capacitors at the load. The most effective technique is to locate low ESR ceramic and electrolytic capacitors as close to the load as possible, using several parallel capacitors to lower the effective ESR. The ceramic capacitors will handle high-frequency dynamic load changes while the electrolytic capacitors are used to handle low frequency dynamic load changes. It is equally important to use low resistance and low inductance PCB layouts and cabling.

External decoupling capacitors will become part of the control loop of the DC/DC converter and may affect the stability margins. As a “rule of thumb”, 100 µF/A of output current can be added without any additional analysis. The ESR of the capacitors is a very important parameter. Power Modules guarantee stable operation with a verified ESR value of >10 mΩ across the output connections. For further information please contact your local Ericsson Power Modules representative.

**Output Voltage Adjust (V<sub>adj</sub>)**

The products have an Output Voltage Adjust pin (V<sub>adj</sub>). This pin can be used to adjust the output voltage above or below Output voltage initial setting. When increasing the output voltage, the voltage at the output pins (including any remote sense compensation ) must be kept below the threshold of the over voltage protection, (OVP) to prevent the converter from shutting down. At increased output voltages the maximum power rating of the converter remains the same, and the max output current must be decreased correspondingly. To increase the voltage the resistor should be connected between the V<sub>adj</sub> pin and +Sense pin. The resistor value of the Output voltage adjust function is according to information given under the Output section for the respective product. To decrease the output voltage, the resistor should be connected between the V<sub>adj</sub> pin and -Sense pin.

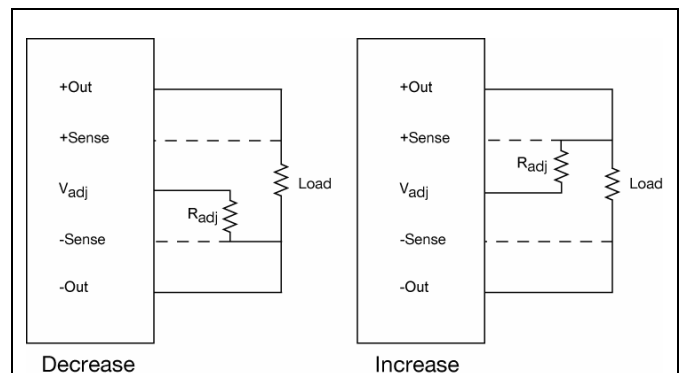

**PKJ 4000 RFPA series** Direct Converters  
 Input 36-75 V, Output up to 12.4 A / 350 W

EN/LZT 146 367 R3B September 2009

© Ericsson AB

**Operating information continued**

**Parallel Operation**

Two converters may be paralleled for redundancy if the total power is equal or less than PO max. It is not recommended to parallel the converters without using external current sharing circuits.

See Design Note 006 for detailed information.

**Remote Sense**

The DC/DC converters have remote sense that can be used to compensate for voltage drops between the output and the point of load. The sense traces should be located close to the PCB ground layer to reduce noise susceptibility. The remote sense circuitry will compensate for up to 10% voltage drop between output pins and the point of load.

If the remote sense is not needed +Sense should be connected to +Out and -Sense should be connected to -Out.

**Over Temperature Protection (OTP)**

The converters are protected from thermal overload by an internal over temperature shutdown circuit. When the baseplate temperature (center of baseplate) exceeds 140°C the converter will shut down(latching). The DC/DC converter can be restarted by cycling the input voltage or using the remote control function.

**Over Voltage Protection (OVP)**

The converters have latching output overvoltage protection. In the event of an overvoltage condition, the converter will shutdown immediately. The converter can be restarted by cycling the input voltage or using the remote control function.

**Over Current Protection (OCP)**

The converters include current limiting circuitry for protection at continuous overload. The output voltage will decrease towards zero for output currents in excess of max output current (max Io). The converter will resume normal operation after removal of the overload. The load distribution should be designed for the maximum output short circuit current specified.

**Thermal Consideration**

**General**

The products are designed to operate in different thermal environments and sufficient cooling must be provided to ensure reliable operation.

For products mounted on a PCB without a heat sink attached, cooling is achieved mainly by conduction, from the pins to the host board, and convection, which is dependant on the airflow across the product. Increased airflow enhances the cooling of the product. The Output Current Derating graph found in the Output section for each model provides the available output current vs. ambient air temperature and air velocity at  $V_i = 53 V$ .

The product is tested on a 254 x 254 mm, 35  $\mu m$  (1 oz), 16-layer test board mounted vertically in a wind tunnel with a cross-section of 608 x 203 mm.

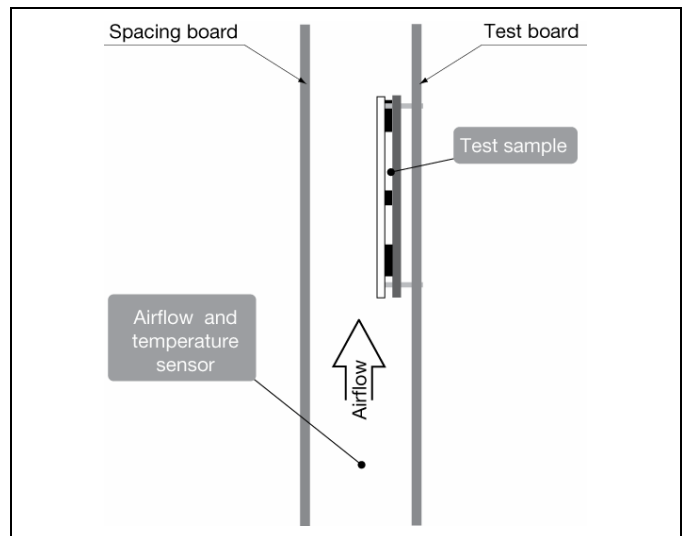

For products with base plate used in a sealed box/cold wall application, cooling is achieved mainly by conduction through the cold wall. The Output Current Derating graphs are found in the Output section for each model. The product is tested in a sealed box test set up with ambient temperatures 85, 55 and 35°C. See Design Note 028 for further details.

**PKJ 4000 RFPA series Direct Converters**  
 Input 36-75 V, Output up to 12.4 A / 350 W

EN/LZT 146 367 R3B September 2009  
 © Ericsson AB

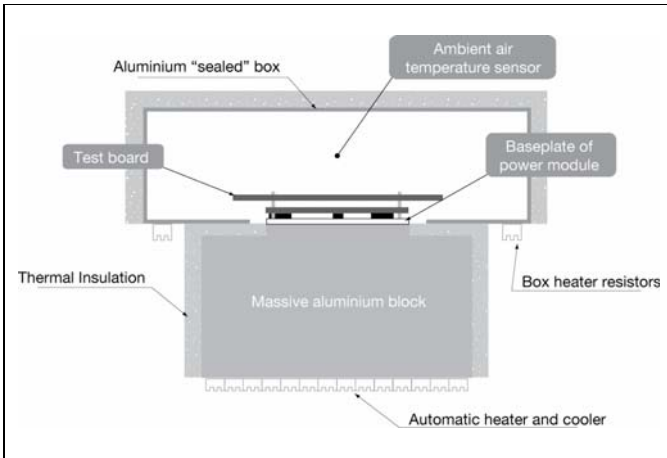

Proper cooling of the product can be verified by measuring the temperature at positions P1, P2. The temperature at these positions should not exceed the max values provided in the table below. The number of points may vary with different thermal design and topology.

See Design Note 019 for further information.

Position	Description	Temp. limit
P1	Reference Point, Baseplate	120° C
P2	PCB	110° C

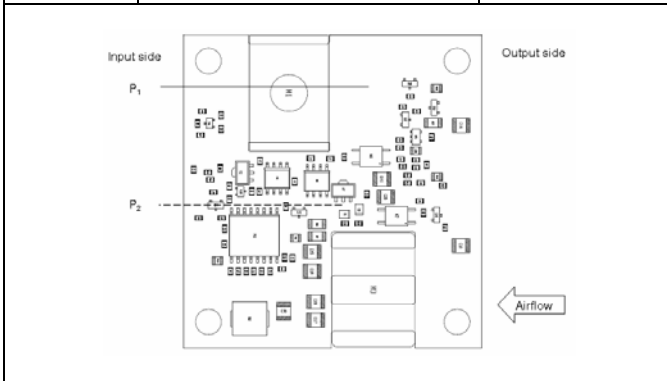

Base plate

**Definition of reference temperature  $T_{P1}$**

The reference temperature is used to monitor the temperature limits of the product. Temperatures above maximum  $T_{P1}$ , measured at the reference point P1 are not allowed and may cause degradation or permanent damage to the product.  $T_{P1}$  is also used to define the temperature range for normal operating conditions.  $T_{P1}$  is defined by the design and used to guarantee safety margins, proper operation and high reliability to the product.

**Ambient Temperature Calculation**

For products with base plate the maximum allowed ambient temperature can be calculated by using the thermal resistance.

1. The power loss is calculated by using the formula  $((1/\eta) - 1) \times \text{output power} = \text{power losses (Pd)}$ .  
 $\eta$  = efficiency of product. E.g. 89.5% = 0.895
2. Find the thermal resistance ( $R_{th}$ ) in the Thermal Resistance graph found in the Output section for each model. **Note that the thermal resistance can be significantly reduced if a heat sink is mounted on the top of the base plate.**

Calculate the temperature increase ( $\Delta T$ ).  
 $\Delta T = R_{th} \times P_d$

3. Max allowed ambient temperature is:  
 $\text{Max } T_{P1} - \Delta T$ .

E.g PKJ 4316 API at 2m/s:

1.  $((\frac{1}{0.87}) - 1) \times 350 \text{ W} = 52.3 \text{ W}$
2.  $52.3 \text{ W} \times 1.8^\circ\text{C/W} = 94.1^\circ\text{C}$
3.  $120^\circ\text{C} - 94.1^\circ\text{C} = \text{max ambient temperature is } 25.9^\circ\text{C}$ .

The actual temperature will be dependent on several factors such as the PCB size, number of layers and direction of airflow.



**PKJ 4000 RFPA series** Direct Converters  
 Input 36-75 V, Output up to 12.4 A / 350 W

EN/LZT 146 367 R3B September 2009

© Ericsson AB

**Connections**

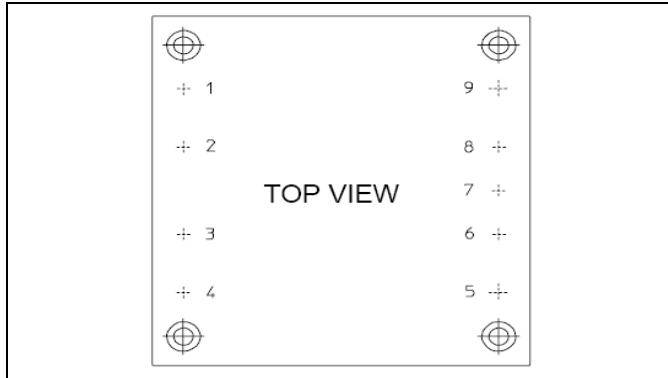

Pin	Designation	Function
1	+In	Positive input
2	RC	Remote control
3	Case	Connected to base plate
4	-In	Negative input
5	-Out	Negative output
6	-Sen	Negative sense
7	Vadj	Output voltage adjust
8	+Sen	Positive sense
9	+Out	Positive output

**PKJ 4000 RFPA series Direct Converters**  
 Input 36-75 V, Output up to 12.4 A / 350 W

EN/LZT 146 367 R3B September 2009

© Ericsson AB

**Mechanical Information**

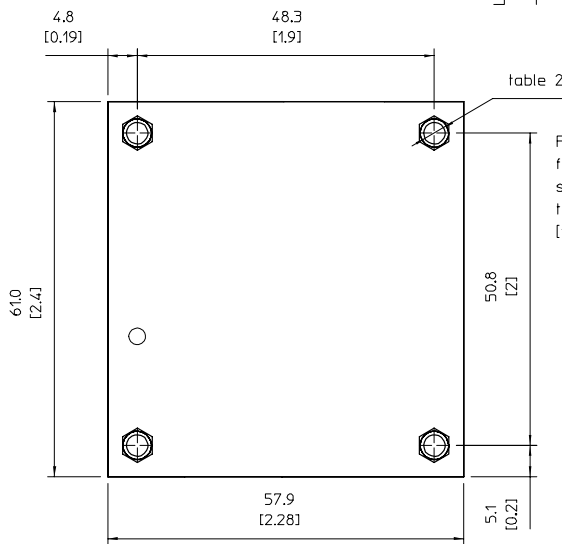
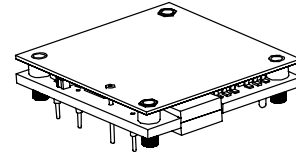
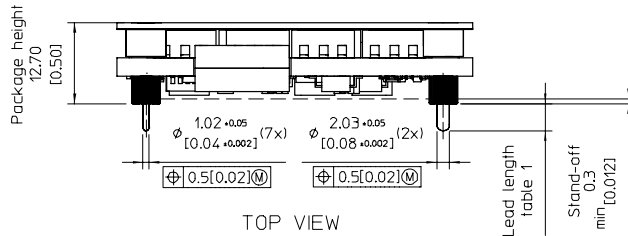

Table 1

Pin Option	Lead length
Standard	5.33 [0.21]
LA	3.69 [0.145]

Table 2

Mechanical Option	
Standard	Screw M3x0.5 (4x)
M-Option	No Screw (4x) ø3.5 through hole

Recommended Footprint - TOP VIEW

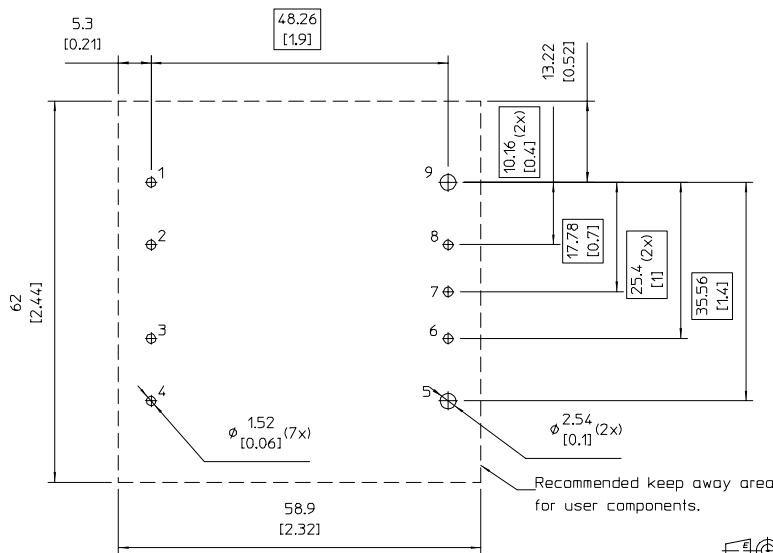

Weight: Typical 90 g

Pins:  
 Material, Pin1-4, Pin 6-8 : Brass alloy  
 Material, Pin5, 9 : Cu-Te  
 Plating : 0.1 µm Gold over 2 µm Nickel

Note 1.  
 For screw attachment from the top side/heat sink, the mounting torque can be increased to max 0.34 Nm [3 IN-LBS]

All dimensions in mm [inch].  
 Tolerances unless specified  
 x.x mm ±0.5 mm [0.020]  
 x.xx mm ±0.25 mm [0.010]  
 (not applied on footprint or typical values)



**PKJ 4000 RFP series Direct Converters**  
 Input 36-75 V, Output up to 12.4 A / 350 W

EN/LZT 146 367 R3B September 2009

© Ericsson AB

### Soldering Information

The product is intended for manual or wave soldering. When wave soldering is used, the temperature on the pins is specified to maximum 270 °C for maximum 10 seconds.

A maximum preheat rate of 4°C/s and a temperature of max of +150°C is suggested. When soldering by hand, care should be taken to avoid direct contact between the hot soldering iron tip and the pins for more than a few seconds in order to prevent overheating.

A no-clean flux is recommended to avoid entrapment of cleaning fluids in cavities inside the product or between the product and the host board. The cleaning residues may affect long time reliability and isolation voltage.

### Delivery Package Information

The products are delivered in antistatic clamshell trays.

#### Clamshell Specifications

<b>Material</b>	Conductive/dissipative PET
<b>Surface resistance</b>	$10^5 < \text{Ohm/square} < 10^{12}$
<b>Bake ability</b>	The clamshells are not bake able.
<b>Clamshell capacity</b>	10 products/clamshell
<b>Clamshell thickness</b>	25 mm [0.984 inch]
<b>Box capacity</b>	50 products (5 full clamshells/box)
<b>Clamshell weight</b>	150 g empty, typical 1050 g one full clamshell

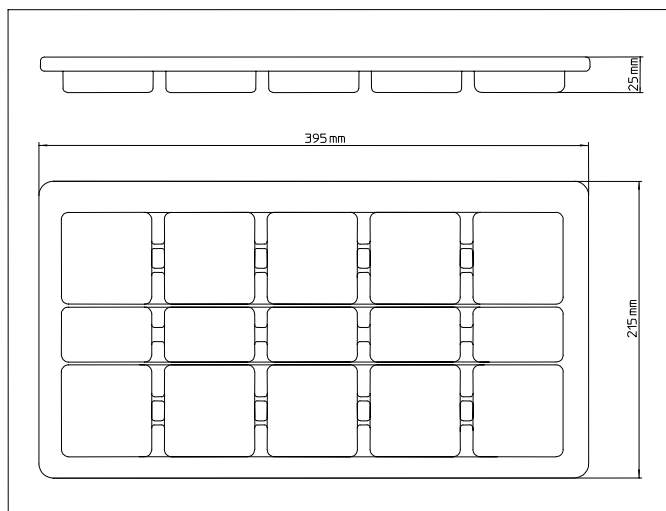

**PKJ 4000 RFPA series** Direct Converters  
 Input 36-75 V, Output up to 12.4 A / 350 W

EN/LZT 146 367 R3B September 2009

© Ericsson AB

**Product Qualification Specification**

Characteristics			
External visual inspection	IPC-A-610		
Dry heat	IEC 60068-2-2 Bd	Temperature Duration	+125 °C 1000 h
Cold (in operation)	IEC 60068-2-1 Ad	Temperature T <sub>A</sub> Duration	-45 °C 72 h
Damp heat	IEC 60068-2-67 Cy	Temperature Humidity Duration	+85 °C 85 % RH 1000 hours
Operational life test	MIL-STD-202G method 108A	Duration	1000 h
Change of temperature (Temperature cycling)	IEC 60068-2-14 Na	Temperature range Number of cycles Dwell/transfer time	-40 to +100 °C 1000 15 min/0-1 min
Vibration, broad band random	IEC 60068-2-64 Fh, method 1	Frequency Spectral density Duration	10 to 500 Hz 0.07 g <sup>2</sup> /Hz 10 min in each 3 perpendicular directions
Mechanical shock	IEC 60068-2-27 Ea	Peak acceleration Duration Pulse shape Directions Number of pulses	100 g 6 ms Half sine 6 18 (3 + 3 in each perpendicular direction)
Robustness of terminations	IEC 60068-2-21 Test Ua1	Plated through hole mount products	All leads
Resistance to soldering heat	IEC 60068-2-20 Tb Method 1A	Solder temperature Duration	270° C 10-13 s
Solderability	IEC 60068-2-20 test Ta	Preconditioning Temperature, SnPb Eutectic Temperature, Pb-free	Steam ageing 235° C 260° C
Immersion in cleaning solvents	IEC 60068-2-45 XA Method 2	Water Glycol ether Isopropanol	+55° C +35° C +35° C



Компания «ЭлектроПласт» предлагает заключение долгосрочных отношений при поставках импортных электронных компонентов на взаимовыгодных условиях!

Наши преимущества:

- Оперативные поставки широкого спектра электронных компонентов отечественного и импортного производства напрямую от производителей и с крупнейших мировых складов;
- Поставка более 17-ти миллионов наименований электронных компонентов;
- Поставка сложных, дефицитных, либо снятых с производства позиций;
- Оперативные сроки поставки под заказ (от 5 рабочих дней);
- Экспресс доставка в любую точку России;
- Техническая поддержка проекта, помощь в подборе аналогов, поставка прототипов;
- Система менеджмента качества сертифицирована по Международному стандарту ISO 9001;
- Лицензия ФСБ на осуществление работ с использованием сведений, составляющих государственную тайну;
- Поставка специализированных компонентов (Xilinx, Altera, Analog Devices, Intersil, Interpoint, Microsemi, Aeroflex, Peregrine, Syfer, Eurofarad, Texas Instrument, Miteq, Cobham, E2V, MA-COM, Hittite, Mini-Circuits, General Dynamics и др.);

Помимо этого, одним из направлений компании «ЭлектроПласт» является направление «Источники питания». Мы предлагаем Вам помощь Конструкторского отдела:

- Подбор оптимального решения, техническое обоснование при выборе компонента;
- Подбор аналогов;
- Консультации по применению компонента;
- Поставка образцов и прототипов;
- Техническая поддержка проекта;
- Защита от снятия компонента с производства.



#### Как с нами связаться

**Телефон:** 8 (812) 309 58 32 (многоканальный)

**Факс:** 8 (812) 320-02-42

**Электронная почта:** [org@eplast1.ru](mailto:org@eplast1.ru)

**Адрес:** 198099, г. Санкт-Петербург, ул. Калинина, дом 2, корпус 4, литера А.