

General Specifications

Electrical Capacity (Resistive Load)

Low/Logic Level: 50mA @ 24V DC

Other Ratings

Contact Resistance:	50 milliohms maximum
Insulation Resistance:	500 megohms minimum @ 250V DC
Dielectric Strength:	250V AC minimum for 1 minute minimum
Mechanical Life:	500,000 operations minimum
Electrical Life:	500,000 operations minimum
Nominal Operating Force:	1.96N for sculptured actuator 2.0N for piano actuator 3.0N for square & round flush actuators
Total Travel:	Flush Actuators .016" (0.4mm) Sculptured & Piano Actuators .031" (0.8mm)

Materials & Finishes

Actuator:	Polyamide
Case:	Glass fiber reinforced polyamide
Seal:	Nitrile butadiene rubber
Base:	Glass fiber reinforced polyester
Movable Contact:	Phosphor bronze with silver plating
Stationary Contacts:	Brass with silver plating
Terminals:	Brass with silver plating

Environmental Data

Operating Temperature Range:	-25°C through +85°C (-13°F through +185°F)
Humidity:	90 ~ 95% humidity for 96 hours @ 40°C (104°F)
Vibration:	10 ~ 55Hz with peak-to-peak amplitude of 1.5mm traversing the frequency range & returning in 1 minute; 3 right angled directions for 2 hours
Shock:	50G (490m/s ²) acceleration (tested in 6 right angled directions, with 5 shocks in each direction)

PCB Processing

Soldering:	Wave Soldering Recommended. See Profile A in Supplement section. Manual Soldering: See Profile A in Supplement section.
Cleaning:	Automated cleaning. See Cleaning specifications in Supplement section.

Standards & Certifications

The JF Series tactiles have not been tested for UL recognition or CSA certification. These switches are designed for use in a low-voltage, low-current, logic-level circuit. When used as intended in a logic-level circuit, the results do not produce hazardous energy.

Distinctive Characteristics

Extremely low profile of 5mm from PCB to top of switch.

Rubber seal construction prevents contact contamination and allows automated soldering and cleaning.

Minimal operating force and short stroke permit light touch operation.

Dome contact gives crisp tactile and audible feedback to positively indicate circuit transfer and assures high reliability and long life.

Wide choice of body shapes and colors.

Crimped terminals provide a spring type action to ensure secure mounting and prevent dislodging during wave soldering.

Space saving body dimensions provide for compact, side-by-side mounting on a standard grid.

Terminal spacing conforms to standard .100" (2.54mm) PCB grid.

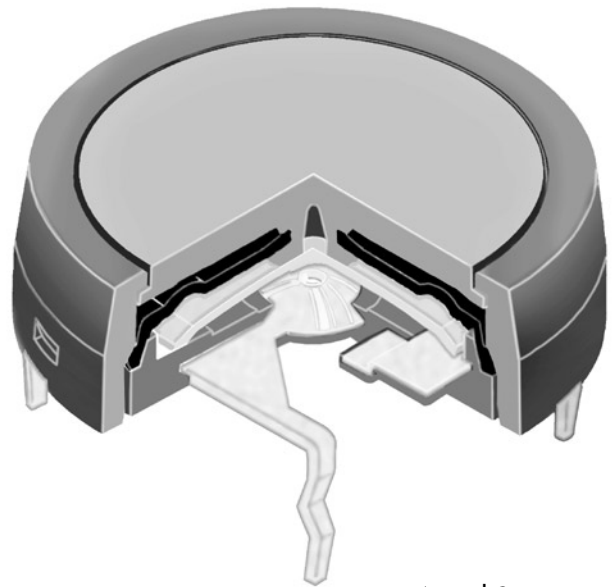

Actual Size



Common Bus Matrix

These single pole, single throw switches can be used in a keyboard matrix and, using strapped terminals, achieve a common bus electrical configuration on a single-sided PC board.

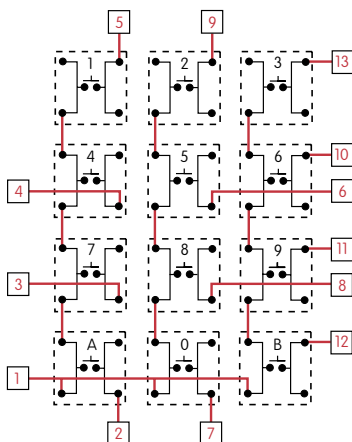

PC Terminations		1	2	3	4	5	6	7	8	9	10	11	12	13
Keys (Switches)	1													
2														
3														
4														
5														
6														
7														
8														
9														
0														
A														
B														

● = ON

X-Y Matrix

These single pole, single throw switches can be arranged on a single-sided PC board matrix with strapped terminals to achieve an X-Y type electrical interconnection.

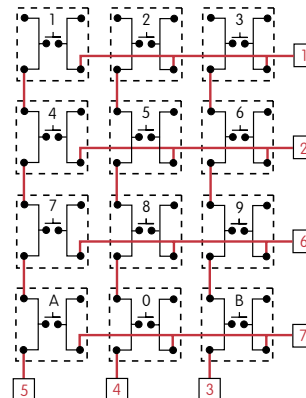

PC Terminations		1	2	3	4	5	6	7
Keys (Switches)	1							
2								
3								
4								
5								
6								
7								
8								
9								
0								
A								
B								

● = ON

Red = PCB Trace Black = Switch Circuit

TYPICAL SWITCH ORDERING EXAMPLE

JF **15** **S** **P** **2** **C**

Pole & Circuit			
15	SPST	OFF	(ON)
() = Momentary			

Terminals	
P	Straight PC

Actuator Colors	
C	Red
D	Orange
F	Green
G	Blue
H	Gray

Housing Shapes	
C	Round (with round actuator only)
S	Square

Actuator Types	
1	Square
2	Round
3	Sculptured
4	Piano

DESCRIPTION FOR TYPICAL ORDERING EXAMPLE

JF15SP2C

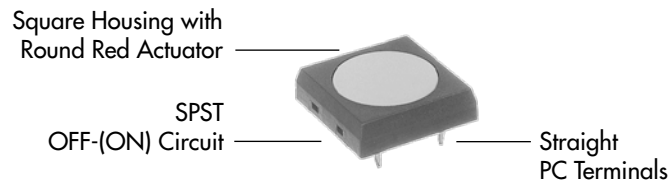

POLE & CIRCUIT

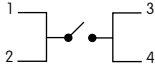
Pole	Model	Actuator Position () = Momentary		Switch Throw & Schematic	Note: Terminal numbers are shown on the switch.
		Normal	Down		
SP	JF15	OFF	(ON)	SPST 	

Toggles
Rockers
Pushbuttons
Illuminated PB
Programmable
Keylocks
Rotaries
Slides
Tactiles
Tilt
Touch
Indicators
Accessories
Supplement

HOUSING SHAPES & ACTUATOR TYPES

C Round Housing

S Square Housing

2 Round Actuator

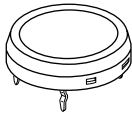

1 Square Actuator

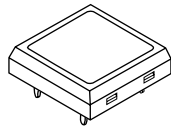

2 Round Actuator

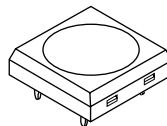

3 Sculptured Actuator

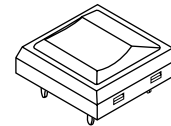

4 Piano Actuator

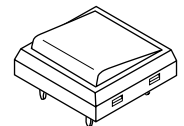

Actuator Colors Available:

C Red

D Orange

F Green

G Blue

H Gray

Housing is Black

TERMINALS & PANEL DESIGN

P Straight PC

Additional details in Typical Switch Dimensions

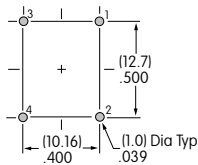
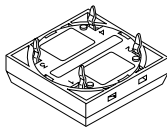

Versatile panel arrangements can be made to fit individual design needs.

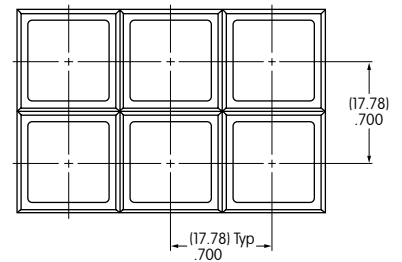
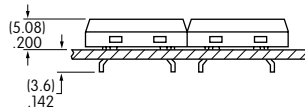

TYPICAL SWITCH DIMENSIONS

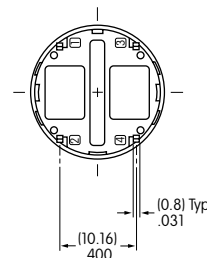
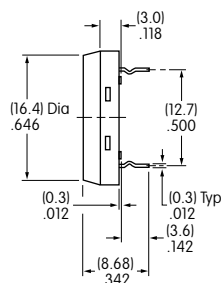
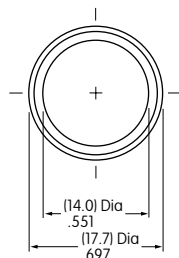

Round Actuator



JF15CP2C

TYPICAL SWITCH DIMENSIONS

Square Actuator

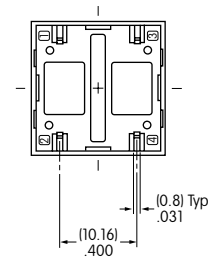
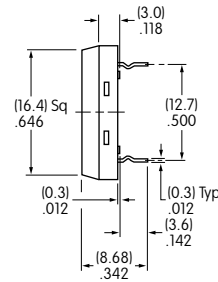
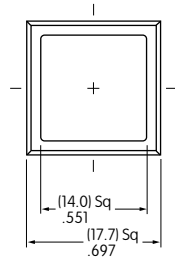

JF15SP1C

Round Actuator

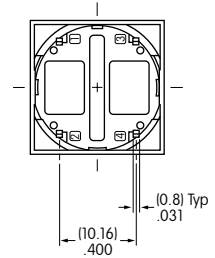
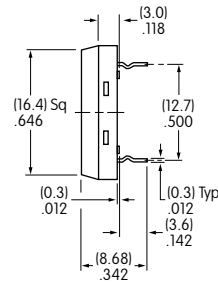
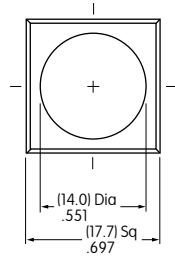

JF15SP2C

Sculptured Actuator

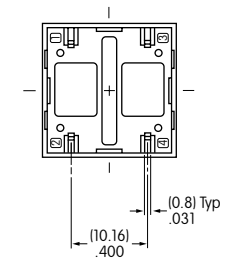
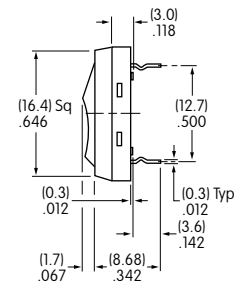
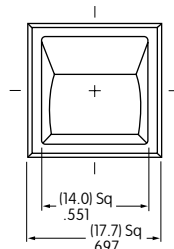
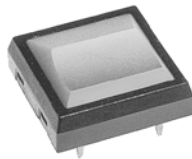

JF15SP3C

Piano Actuator

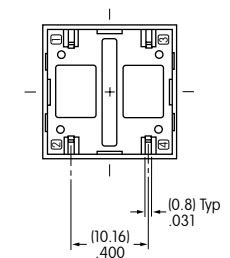
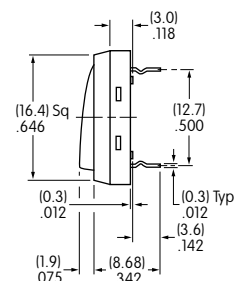
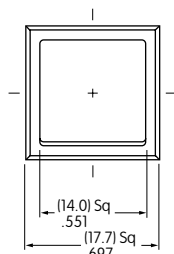
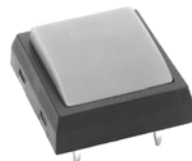

JF15SP4C

Toggles

Rockers

Pushbuttons

Illuminated PB

Programmable

Keylocks

Rotaries

Slides

Tactiles

Tilt

Touch

Indicators

Accessories

Supplement

LEGENDS

NKK Switches can provide custom legends for caps. Contact factory for more information.

Shaded Areas are Printable Areas

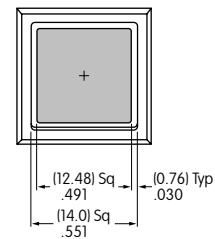
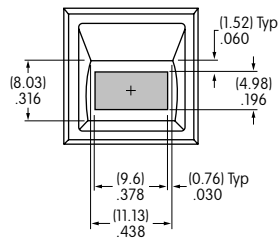
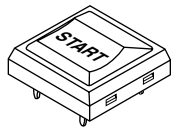
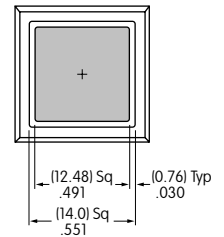
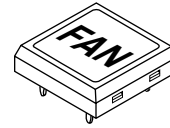
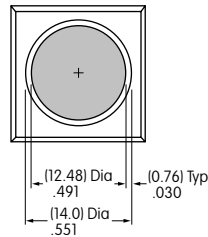
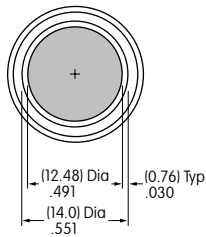

Recommended Print Methods: Screen Print or Pad Print. Epoxy based ink is recommended.



Компания «ЭлектроПласт» предлагает заключение долгосрочных отношений при поставках импортных электронных компонентов на взаимовыгодных условиях!

Наши преимущества:

- Оперативные поставки широкого спектра электронных компонентов отечественного и импортного производства напрямую от производителей и с крупнейших мировых складов;
- Поставка более 17-ти миллионов наименований электронных компонентов;
- Поставка сложных, дефицитных, либо снятых с производства позиций;
- Оперативные сроки поставки под заказ (от 5 рабочих дней);
- Экспресс доставка в любую точку России;
- Техническая поддержка проекта, помощь в подборе аналогов, поставка прототипов;
- Система менеджмента качества сертифицирована по Международному стандарту ISO 9001;
- Лицензия ФСБ на осуществление работ с использованием сведений, составляющих государственную тайну;
- Поставка специализированных компонентов (Xilinx, Altera, Analog Devices, Intersil, Interpoint, Microsemi, Aeroflex, Peregrine, Syfer, Eurofarad, Texas Instrument, Miteq, Cobham, E2V, MA-COM, Hittite, Mini-Circuits, General Dynamics и др.);

Помимо этого, одним из направлений компании «ЭлектроПласт» является направление «Источники питания». Мы предлагаем Вам помощь Конструкторского отдела:

- Подбор оптимального решения, техническое обоснование при выборе компонента;
- Подбор аналогов;
- Консультации по применению компонента;
- Поставка образцов и прототипов;
- Техническая поддержка проекта;
- Защита от снятия компонента с производства.



Как с нами связаться

Телефон: 8 (812) 309 58 32 (многоканальный)

Факс: 8 (812) 320-02-42

Электронная почта: org@eplast1.ru

Адрес: 198099, г. Санкт-Петербург, ул. Калинина, дом 2, корпус 4, литера А.