

SLOT & HOLE WILL CLEAR ORIENTATION PEG & MATING PIN HOUSING BLADES. PLATING NOT REQUIRED

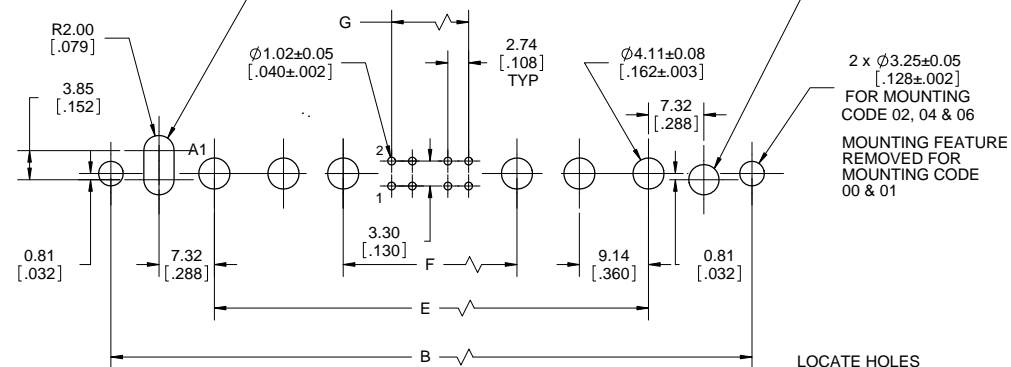

RECOMMENDED PCB LAYOUT (COMPONENT SIDE OF BOARD)

LOCATE HOLES
 \varnothing 0.13 [.005] DIA
 POSITION DIMENSIONS ARE BASIC

REVISIONS			
REV	DESCRIPTION, ECN, EAR NO.	DATE	APP'D
A	PROPOSAL DRAWING	JUN17/11	S.M
B	SOCKET UPDATE	MAR21/12	S.M
C	UPDATE MOUNTING OPTIONS	JUL10/12	S.M

PART NUMBER:

DWR - T X XX S - V X X 3 X - 0X

SERIES

DWR

PRODUCT TYPE

T = SLIMDRAWER FINISHED CONNECTOR

NUMBER OF POWER CONTACT POSITIONS

2, 4, 6 OR 8

NUMBER OF SIGNAL CONTACT POSITIONS

00, 04, 06, 08, 10 ... 40

GENDER

S = SOCKET (FEMALE)

ORIENTATION

V = VERTICAL

CONTACT OPTIONS

2 = COOLBAND POWER SIZE CB8
 3 = COOLBAND POWER SIZE CB10
 STD SIGNAL

CONTACT TERMINATION

3 = PCB TAIL: POWER 3.75mm [.148"] DIA, 3.81mm [.150"] LONG
 STD SIGNAL PCB TAIL

PLATING OPTIONS

2 = 0.38µm [15µ"] GOLD
 3 = 0.76µm [30µ"] GOLD
 6 = 5.08µm [200µ"] SILVER POWER, 0.38µm [15µ"] GOLD SIGNAL

MOUNTING OPTION

00 = NO MOUNTING FEATURE
 01 = NO MOUNTING EARS
 02 = 3.25mm [.128"] DIA THROUGH HOLE FOR MOUNTING OR GUIDE PIN
 04 = #4-40 THREADED HOLE
 06 = M3 THREADED HOLE

SPECIAL CONFIGURATIONS

SPECIAL CODE DESIGNATIONS ARE AVAILABLE FOR SPECIAL CONFIGURATIONS. CONTACT AUTHORIZED AMPHENOL REPRESENTATIVE FOR DETAILS.

NOTES:

- MATERIALS: ALL MATERIALS ARE RoHS COMPLIANT PER EU DIRECTIVE 2002/95/EC AND AMENDMENTS.
 - HOUSING: HIGH TEMPERATURE RESISTANT NYLON, UL FLAMMABILITY RATING 94V-0, COLOUR BLACK
 - SIGNAL CONTACTS: PHOSPHOR BRONZE PLATED WITH GOLD OVER 1.27µm (50µ") NICKEL ON THE MATING AREA AND 2.54µm (100µ") MATTE TIN OVER NICKEL ON THE TAILS.
 - COOLBAND POWER CONTACTS: BERYLLIUM COPPER MATING GRID, COPPER ALLOY BALANCE, PLATED WITH GOLD OR SILVER OVER 1.27µm (50µ") NICKEL ON THE MATING GRID AND SILVER OVER NICKEL OR MATTE TIN BALANCE.
- WHEN MATED WITH PIN CONNECTOR DWR-TXXXP-VXXX-XX, THE ORDER OF MECHANICAL AND ELECTRICAL ENGAGEMENT IS A) HOUSING BLADES, B) HOUSING SHROUD, C) POWER CONTACTS AND D) SIGNAL CONTACTS.
- RATINGS SUBJECT TO DESIGN QUALIFICATION TESTING
 - CURRENT RATING: UP TO 55A POWER, 5A SIGNAL
 - DIELECTRIC WITHSTANDING VOLTAGE: 1500VDC
 - INSULATION RESISTANCE: 5000 MEGAOHMS
 - OPERATING TEMPERATURE: -55C TO +105C

UNLESS SPECIFIED OTHERWISE	DRAWN	S.CAELERS	MAR17/11
PRIMARY UNITS MILLIMETERS	CHECKED	S.MUGAN	JUN17/11
SECONDARY INCHES	M.E. APP'D		
REFERENCE IN PARENTHESES	Q.A. APP'D		
GENERAL TOLERANCES	DWG APPR.		
1 DECIMAL PLACE	ENG. REL. NO.		
2 DECIMAL PLACES	REF.		
3 DECIMAL PLACES	THIRD ANGLE PROJECTION		
ANGULAR DEGREES	DO NOT SCALE DRAWING		

Amphenol Canada Corp.

DWR SERIES SLIM DRAWER SOCKET CONNECTOR, POWER & SIGNAL CONTACTS, VERTICAL PCB TAILS (Ø3.75mm [.148"] x 3.81mm [.150"] LONG), RoHS COMPLIANT

DWG. NO.	REV
P-DWR-TXXXS-VX3X-0X	C
CODE ID NO. 03554	DWG SIZE: C
SCALE: 2:1	SHEET 1 OF 2

Socket Connector Part Number	Number of Power Contacts	Number of Signal Contacts	"A"		"B"		"C"		"D"		"E"		"F"		"G"	
			Overall Length		Mounting Hole Centrelines		Length Without Mounting Ears		Socket Body Length		Outside Power Centrelines		Inside Power Centrelines		Outside Signal Centrelines	
			mm	inch	mm	inch	mm	inch	mm	inch	mm	inch	mm	inch	mm	inch
DWR-T200S-VXXX-XX	2	0	47.70	1.878	36.53	1.438	29.75	1.171	23.98	0.944	9.14	0.360	9.14	0.360	---	---
DWR-T204S-VXXX-XX	2	4	54.10	2.130	42.93	1.690	36.15	1.423	30.38	1.196	15.54	0.612	15.54	0.612	2.74	0.108
DWR-T208S-VXXX-XX	2	8	59.59	2.346	48.41	1.906	41.63	1.639	35.86	1.412	21.03	0.828	21.03	0.828	8.23	0.324
DWR-T212S-VXXX-XX	2	12	65.07	2.562	53.90	2.122	47.12	1.855	41.35	1.628	26.52	1.044	26.52	1.044	13.72	0.540
DWR-T216S-VXXX-XX	2	16	70.56	2.778	59.39	2.338	52.61	2.071	46.84	1.844	32.00	1.260	32.00	1.260	19.20	0.756
DWR-T220S-VXXX-XX	2	20	76.05	2.994	64.87	2.554	58.09	2.287	52.32	2.060	37.49	1.476	37.49	1.476	24.69	0.972
DWR-T224S-VXXX-XX	2	24	81.53	3.210	70.36	2.770	63.58	2.503	57.81	2.276	42.98	1.692	42.98	1.692	30.18	1.188
DWR-T228S-VXXX-XX	2	28	87.02	3.426	75.84	2.986	69.06	2.719	63.30	2.492	48.46	1.908	48.46	1.908	35.66	1.404
DWR-T232S-VXXX-XX	2	32	92.51	3.642	81.33	3.202	74.55	2.935	68.78	2.708	53.95	2.124	53.95	2.124	41.15	1.620
DWR-T236S-VXXX-XX	2	36	97.99	3.858	86.82	3.418	80.04	3.151	74.27	2.924	59.44	2.340	59.44	2.340	46.63	1.836
DWR-T240S-VXXX-XX	2	40	103.48	4.074	92.30	3.634	85.52	3.367	79.76	3.140	64.92	2.556	64.92	2.556	52.12	2.052
DWR-T400S-VXXX-XX	4	0	65.99	2.598	54.81	2.158	48.03	1.891	42.27	1.664	27.43	1.080	9.14	0.360	---	---
DWR-T404S-VXXX-XX	4	4	72.39	2.850	61.21	2.410	54.43	2.143	48.67	1.916	33.83	1.332	15.54	0.612	2.74	0.108
DWR-T408S-VXXX-XX	4	8	77.88	3.066	66.70	2.626	59.92	2.359	54.15	2.132	39.32	1.548	21.03	0.828	8.23	0.324
DWR-T412S-VXXX-XX	4	12	83.36	3.282	72.19	2.842	65.41	2.575	59.64	2.348	44.81	1.764	26.52	1.044	13.72	0.540
DWR-T416S-VXXX-XX	4	16	88.85	3.498	77.67	3.058	70.89	2.791	65.13	2.564	50.29	1.980	32.00	1.260	19.20	0.756
DWR-T420S-VXXX-XX	4	20	94.34	3.714	83.16	3.274	76.38	3.007	70.61	2.780	55.78	2.196	37.49	1.476	24.69	0.972
DWR-T424S-VXXX-XX	4	24	99.82	3.930	88.65	3.490	81.87	3.223	76.10	2.996	61.26	2.412	42.98	1.692	30.18	1.188
DWR-T428S-VXXX-XX	4	28	105.31	4.146	94.13	3.706	87.35	3.439	81.58	3.212	66.75	2.628	48.46	1.908	35.66	1.404
DWR-T432S-VXXX-XX	4	32	110.79	4.362	99.62	3.922	92.84	3.655	87.07	3.428	72.24	2.844	53.95	2.124	41.15	1.620
DWR-T436S-VXXX-XX	4	36	116.28	4.578	105.11	4.138	98.33	3.871	92.56	3.644	77.72	3.060	59.44	2.340	46.63	1.836
DWR-T440S-VXXX-XX	4	40	121.77	4.794	110.59	4.354	103.81	4.087	98.04	3.860	83.21	3.276	64.92	2.556	52.12	2.052
DWR-T600S-VXXX-XX	6	0	84.28	3.318	73.10	2.878	66.32	2.611	60.55	2.384	45.72	1.800	9.14	0.360	---	---
DWR-T604S-VXXX-XX	6	4	90.68	3.570	79.50	3.130	72.72	2.863	66.95	2.636	52.12	2.052	15.54	0.612	2.74	0.108
DWR-T608S-VXXX-XX	6	8	96.16	3.786	84.99	3.346	78.21	3.079	72.44	2.852	57.61	2.268	21.03	0.828	8.23	0.324
DWR-T612S-VXXX-XX	6	12	101.65	4.002	90.47	3.562	83.69	3.295	77.93	3.068	63.09	2.484	26.52	1.044	13.72	0.540
DWR-T616S-VXXX-XX	6	16	107.14	4.218	95.96	3.778	89.18	3.511	83.41	3.284	68.58	2.700	32.00	1.260	19.20	0.756
DWR-T620S-VXXX-XX	6	20	112.62	4.434	101.45	3.994	94.67	3.727	88.90	3.500	74.07	2.916	37.49	1.476	24.69	0.972
DWR-T624S-VXXX-XX	6	24	118.11	4.650	106.93	4.210	100.15	3.943	94.39	3.716	79.55	3.132	42.98	1.692	30.18	1.188
DWR-T628S-VXXX-XX	6	28	123.60	4.866	112.42	4.426	105.64	4.159	99.87	3.932	85.04	3.348	48.46	1.908	35.66	1.404
DWR-T632S-VXXX-XX	6	32	129.08	5.082	117.91	4.642	111.13	4.375	105.36	4.148	90.53	3.564	53.95	2.124	41.15	1.620
DWR-T636S-VXXX-XX	6	36	134.57	5.298	123.39	4.858	116.61	4.591	110.85	4.364	96.01	3.780	59.44	2.340	46.63	1.836
DWR-T640S-VXXX-XX	6	40	140.06	5.514	128.88	5.074	122.10	4.807	116.33	4.580	101.50	3.996	64.92	2.556	52.12	2.052
DWR-T800S-VXXX-XX	8	0	102.57	4.038	91.39	3.598	84.61	3.331	78.84	3.104	64.01	2.520	9.14	0.360	---	---
DWR-T804S-VXXX-XX	8	4	108.97	4.290	97.79	3.850	91.01	3.583	85.24	3.356	70.41	2.772	15.54	0.612	2.74	0.108
DWR-T808S-VXXX-XX	8	8	114.45	4.506	103.28	4.066	96.50	3.799	90.73	3.572	75.90	2.988	21.03	0.828	8.23	0.324
DWR-T812S-VXXX-XX	8	12	119.94	4.722	108.76	4.282	101.98	4.015	96.22	3.788	81.38	3.204	26.52	1.044	13.72	0.540
DWR-T816S-VXXX-XX	8	16	125.43	4.938	114.25	4.498	107.47	4.231	101.70	4.004	86.87	3.420	32.00	1.260	19.20	0.756
DWR-T820S-VXXX-XX	8	20	130.91	5.154	119.74	4.714	112.96	4.447	107.19	4.220	92.35	3.636	37.49	1.476	24.69	0.972
DWR-T824S-VXXX-XX	8	24	136.40	5.370	125.22	4.930	118.44	4.663	112.67	4.436	97.84	3.852	42.98	1.692	30.18	1.188
DWR-T828S-VXXX-XX	8	28	141.88	5.586	130.71	5.146	123.93	4.879	118.16	4.652	103.33	4.068	48.46	1.908	35.66	1.404
DWR-T832S-VXXX-XX	8	32	147.37	5.802	136.19	5.362	129.41	5.095	123.65	4.868	108.81	4.284	53.95	2.124	41.15	1.620
DWR-T836S-VXXX-XX	8	36	152.86	6.018	141.68	5.578	134.90	5.311	129.13	5.084	114.30	4.500	59.44	2.340	46.63	1.836
DWR-T840S-VXXX-XX	8	40	158.34	6.234	147.17	5.794	140.39	5.527	134.62	5.300	119.79	4.716	64.92	2.556	52.12	2.052

FOR INTERMEDIATE CONFIGURATIONS (NUMBER OF SIGNAL CONTACTS = 06, 10, 14 ...) DIMENSIONS CAN BE CALCULATED BY AVERAGING VALUES IMMEDIATELY BEFORE AND AFTER. FOR EXAMPLE, DIMENSIONS OF DWR-T206S-VXXX-XX CAN BE OBTAINED BY AVERAGING VALUES CORRESPONDING TO DWR-T204S-VXXX-XX AND DWR-T208S-VXXX-XX.

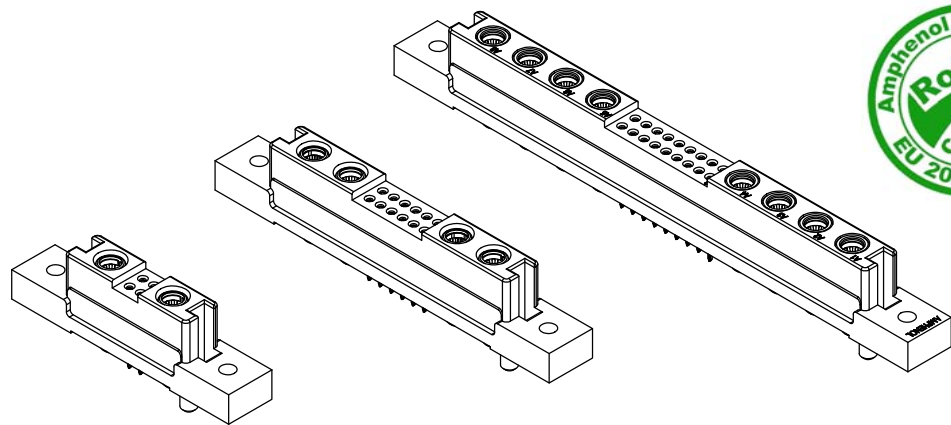

REVISIONS			
REV	DESCRIPTION, ECN, EAR NO.	DATE	APP'D
A	PROPOSAL DRAWING	JUN17/11	S.M
B	SOCKET UPDATE	JAN23/12	S.M
C	UPDATE MOUNTING OPTIONS	JUL10/12	S.M

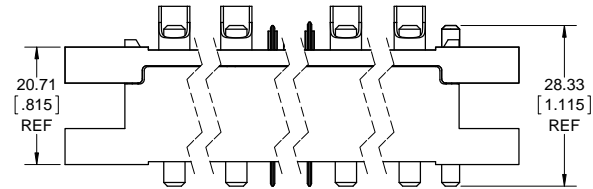

PIN AND SOCKET MATED ASSEMBLY

MOUNTING OPTIONS

MOUNTING CODE: 00

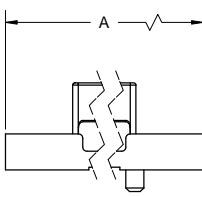

MOUNTING CODE: 01

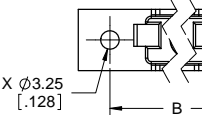
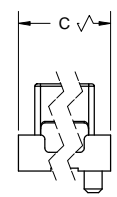
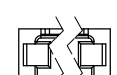

MOUNTING CODE: 02

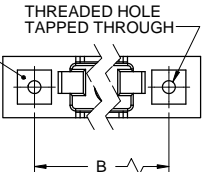

MOUNTING CODE: 04, 06

THIS DOCUMENT CONTAINS PROPRIETARY INFORMATION AND SUCH INFORMATION MAY NOT BE DISCLOSED TO OTHERS FOR ANY PURPOSE OR USED FOR MANUFACTURING PURPOSES WITHOUT WRITTEN PERMISSION FROM AMPHENOL CANADA CORP.

UNLESS SPECIFIED OTHERWISE	DRAWN	S.CAELERS	MAR17/11
PRIMARY UNITS	MILLIMETERS	CHECKED	S.MUGAN
SECONDARY UNITS	INCHES	M.E. APP'D	JUN17/11
REFERENCE IN PARENTHESES	Q.A. APP'D		
GENERAL TOLERANCES	DWG APPR.		
1 DECIMAL PLACE	ENG. REL. NO.		
2 DECIMAL PLACES	REF.		
3 DECIMAL PLACES	THIRD ANGLE PROJECTION		
ANGULAR DEGREES	DO NOT SCALE DRAWING		

Amphenol Canada Corp.

DWR SERIES SLIM DRAWER SOCKET CONNECTOR, POWER & SIGNAL CONTACTS, VERTICAL PCB TAILS (Ø3.75mm [.148"] x 3.81mm [.150"] LONG), RoHS COMPLIANT

DWG. NO. **P-DWR-TXXXS-VX3X-0X** REV **C**

CODE ID NO. 03554 DWG SIZE: C SCALE: 2:1 SHEET 2 OF 2



Компания «ЭлектроПласт» предлагает заключение долгосрочных отношений при поставках импортных электронных компонентов на взаимовыгодных условиях!

Наши преимущества:

- Оперативные поставки широкого спектра электронных компонентов отечественного и импортного производства напрямую от производителей и с крупнейших мировых складов;
- Поставка более 17-ти миллионов наименований электронных компонентов;
- Поставка сложных, дефицитных, либо снятых с производства позиций;
- Оперативные сроки поставки под заказ (от 5 рабочих дней);
- Экспресс доставка в любую точку России;
- Техническая поддержка проекта, помощь в подборе аналогов, поставка прототипов;
- Система менеджмента качества сертифицирована по Международному стандарту ISO 9001;
- Лицензия ФСБ на осуществление работ с использованием сведений, составляющих государственную тайну;
- Поставка специализированных компонентов (Xilinx, Altera, Analog Devices, Intersil, Interpoint, Microsemi, Aeroflex, Peregrine, Syfer, Eurofarad, Texas Instrument, Miteq, Cobham, E2V, MA-COM, Hittite, Mini-Circuits, General Dynamics и др.);

Помимо этого, одним из направлений компании «ЭлектроПласт» является направление «Источники питания». Мы предлагаем Вам помощь Конструкторского отдела:

- Подбор оптимального решения, техническое обоснование при выборе компонента;
- Подбор аналогов;
- Консультации по применению компонента;
- Поставка образцов и прототипов;
- Техническая поддержка проекта;
- Защита от снятия компонента с производства.



Как с нами связаться

Телефон: 8 (812) 309 58 32 (многоканальный)

Факс: 8 (812) 320-02-42

Электронная почта: org@eplast1.ru

Адрес: 198099, г. Санкт-Петербург, ул. Калинина, дом 2, корпус 4, литера А.