

Analog Devices Welcomes Hittite Microwave Corporation

NO CONTENT ON THE ATTACHED DOCUMENT HAS CHANGED



THIS PAGE INTENTIONALLY LEFT BLANK



SMT GaAs MMIC x2 ACTIVE FREQUENCY MULTIPLIER, 18 - 29 GHz OUTPUT

Typical Applications

The HMC576LC3B is suitable for:

- Clock Generation Applications:
SONET OC-192 & SDH STM-64
- Point-to-Point & VSAT Radios
- Test Instrumentation
- Military & Space

Features

- High Output Power: +15 dBm
- Low Input Power Drive: 0 to +6 dBm
- Fo Isolation: >20 dBc @ Fout= 24 GHz
- 100 KHz SSB Phase Noise: -132 dBc/Hz
- Single Supply: +5V@ 82 mA
- RoHS Compliant 3x3 mm SMT Package

Functional Diagram

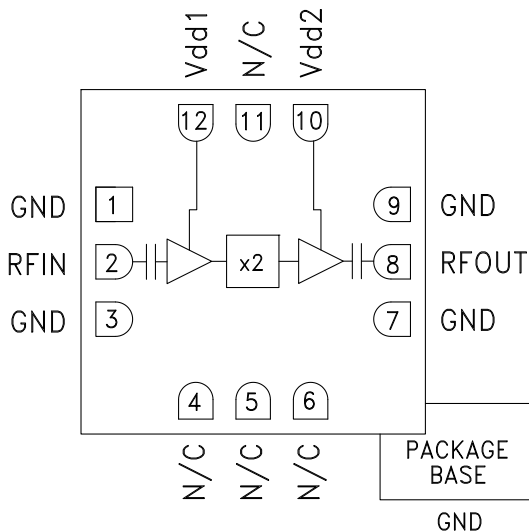

General Description

The HMC576LC3B is a x2 active broadband frequency multiplier utilizing GaAs PHEMT technology in a leadless RoHS compliant SMT package. When driven by a +3 dBm signal, the multiplier provides +15 dBm typical output power from 18 to 29 GHz. The Fo and 3Fo isolations are >20 dBc at 24 GHz. The HMC576LC3B is ideal for use in LO multiplier chains for Pt-to-Pt & VSAT Radios yielding reduced parts count vs. traditional approaches. The low additive SSB Phase Noise of -132 dBc/Hz at 100 kHz offset helps maintain good system noise performance. The RoHS packaged HMC576LC3B eliminates the need for wire bonding, and allows the use of surface mount manufacturing techniques.

Electrical Specifications, $T_A = +25^\circ C$, $V_{dd1}, V_{dd2} = +5V$, 3 dBm Drive Level

Parameter	Min.	Typ.	Max.	Units
Frequency Range, Input	9 - 14.5			GHz
Frequency Range, Output	18 - 29			GHz
Output Power	10	15		dBm
Fo Isolation (with respect to output level)		20		dBc
3Fo Isolation (with respect to output level)		20		dBc
Input Return Loss		10		dB
Output Return Loss		10		dB
SSB Phase Noise (100 kHz Offset)		-132		dBc/Hz
Supply Current (I _{dd1} & I _{dd2})		82		mA

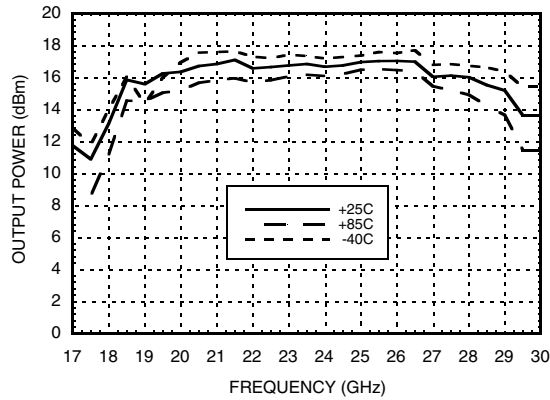
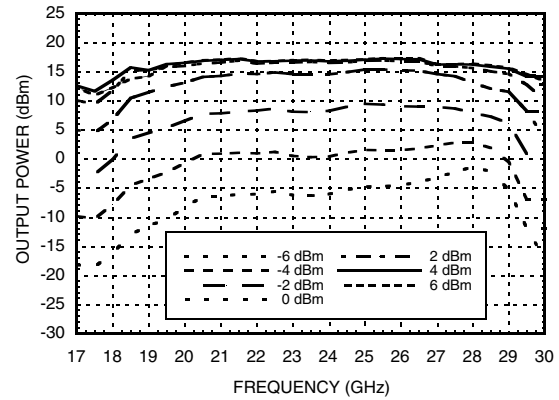
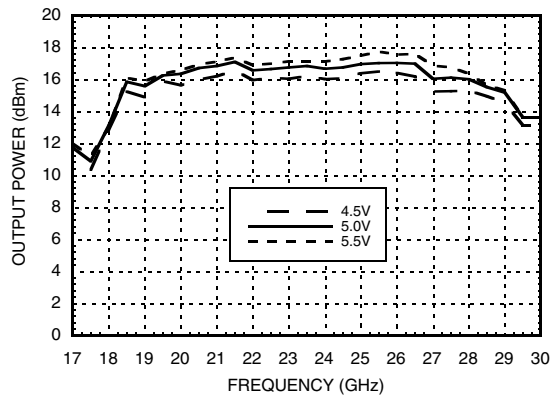
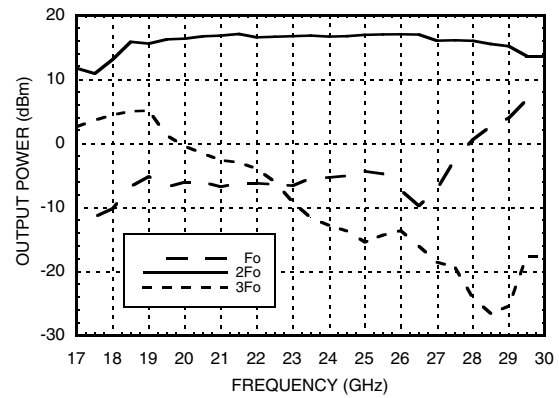
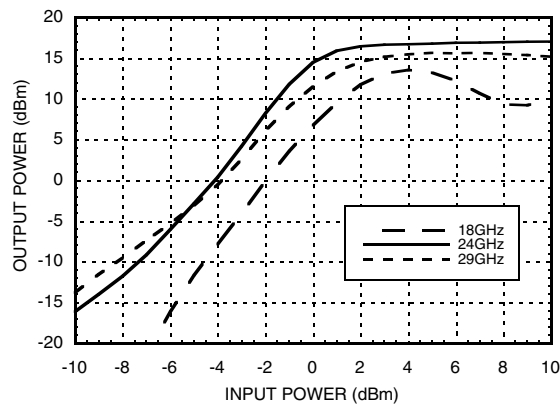
SMT GaAs MMIC x2 ACTIVE FREQUENCY MULTIPLIER, 18 - 29 GHz OUTPUT
Output Power vs. Temperature @ 3 dBm Drive Level

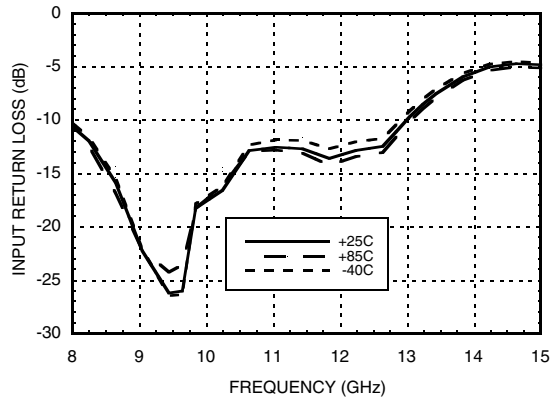
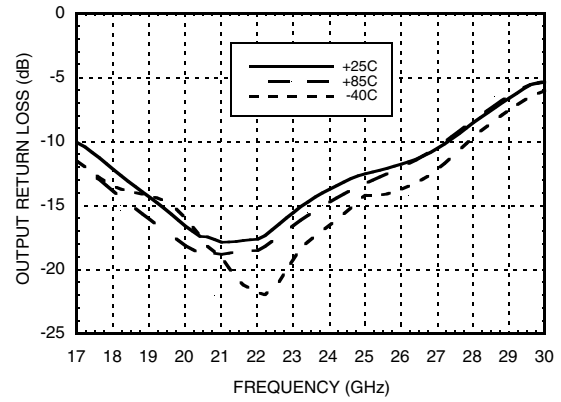
Output Power vs. Drive Level

Output Power vs. Supply Voltage @ 3 dBm Drive Level

Isolation @ 3 dBm Drive Level

Output Power vs. Input Power

**SMT GaAs MMIC x2 ACTIVE FREQUENCY MULTIPLIER, 18 - 29 GHz OUTPUT****Input Return Loss vs. Temperature****Output Return Loss vs. Temperature**

SMT GaAs MMIC x2 ACTIVE FREQUENCY MULTIPLIER, 18 - 29 GHz OUTPUT
Absolute Maximum Ratings

RF Input (Vdd = +5V)	+13 dBm
Supply Voltage (Vdd)	+6.0 Vdc
Channel Temperature	175 °C
Continuous Pdiss (T= 85 °C) (derate 7.5 mW/°C above 85 °C)	676 mW
Thermal Resistance (channel to ground paddle)	133 °C/W
Storage Temperature	-65 to +150 °C
Operating Temperature	-40 to +85 °C

Typical Supply Current vs. Vdd

Vdd (Vdc)	Idd (mA)
4.5	82
5.0	82
5.5	83

Note:
Multiplier will operate over full voltage range shown above.

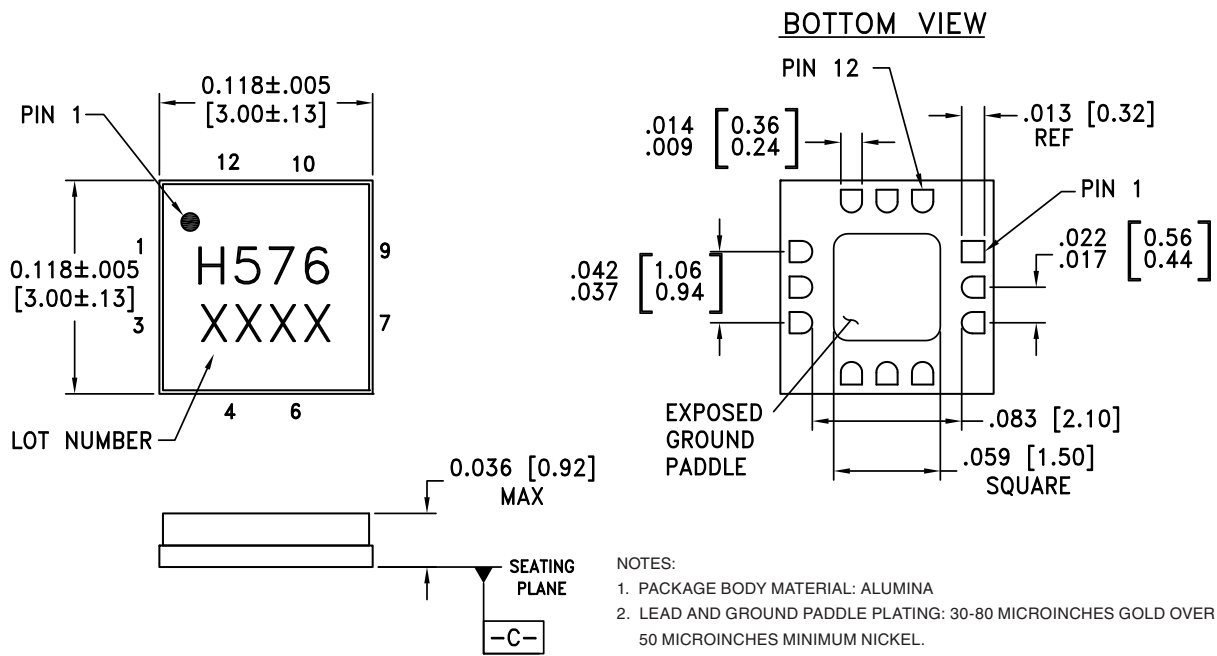

**ELECTROSTATIC SENSITIVE DEVICE
OBSERVE HANDLING PRECAUTIONS**

Outline Drawing

- NOTES:
1. PACKAGE BODY MATERIAL: ALUMINA
 2. LEAD AND GROUND PADDLE PLATING: 30-80 MICROINCHES GOLD OVER 50 MICROINCHES MINIMUM NICKEL.
 3. DIMENSIONS ARE IN INCHES [MILLIMETERS].
 4. LEAD SPACING TOLERANCE IS NON-CUMULATIVE
 5. PACKAGE WARP SHALL NOT EXCEED 0.05mm DATUM $\overline{-C-}$
 6. ALL GROUND LEADS AND GROUND PADDLE MUST BE SOLDERED TO PCB RF GROUND.

Package Information

Part Number	Package Body Material	Lead Finish	MSL Rating	Package Marking ^[2]
HMC576LC3B	Alumina, White	Gold over Nickel	MSL3 ^[1]	H576 XXXX

[1] Max peak reflow temperature of 260 °C

[2] 4-Digit lot number XXXX

SMT GaAs MMIC x2 ACTIVE FREQUENCY MULTIPLIER, 18 - 29 GHz OUTPUT
Pin Description

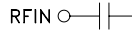
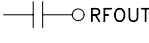
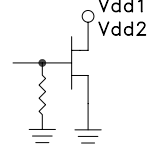
Pin Number	Function	Description	Interface Schematic
1, 3, 7, 9	GND	Package bottom must also be connected to RF/DC ground.	
2	RFIN	Pin is AC coupled and matched to 50 Ohms.	
4 - 6, 11	N/C	These pins are internally not connected; however, this product was specified with these pins connected to RF/DC ground.	
8	RFOUT	Pin is AC coupled and matched to 50 Ohms.	
10, 12	Vdd2, Vdd1	Supply voltage 5V ± 0.5V. External bypass capacitors of 100 pF, 1,000 pF and 2.2 μF are required.	

Application Circuit

Component	Value
C1, C2	100 pF
C3, C4	1,000 pF
C5, C6	2.2 μF

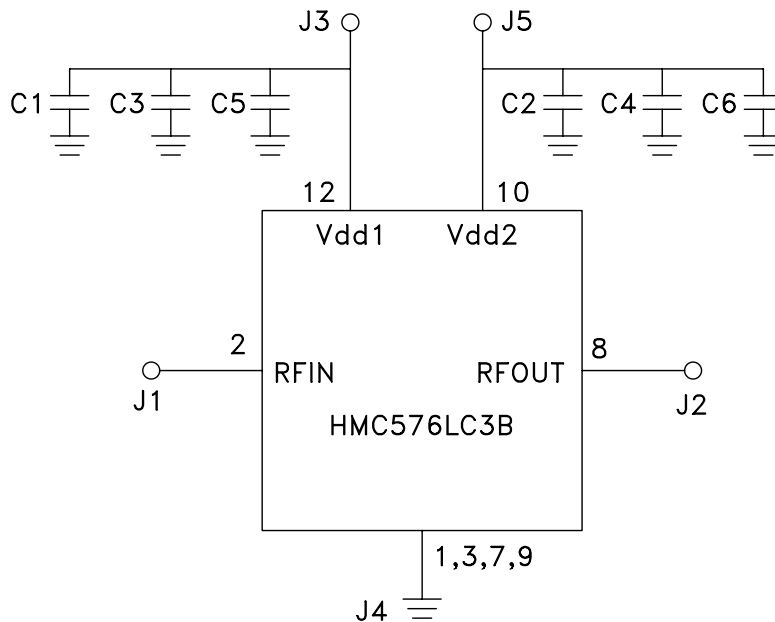

SMT GaAs MMIC x2 ACTIVE FREQUENCY MULTIPLIER, 18 - 29 GHz OUTPUT



Evaluation PCB

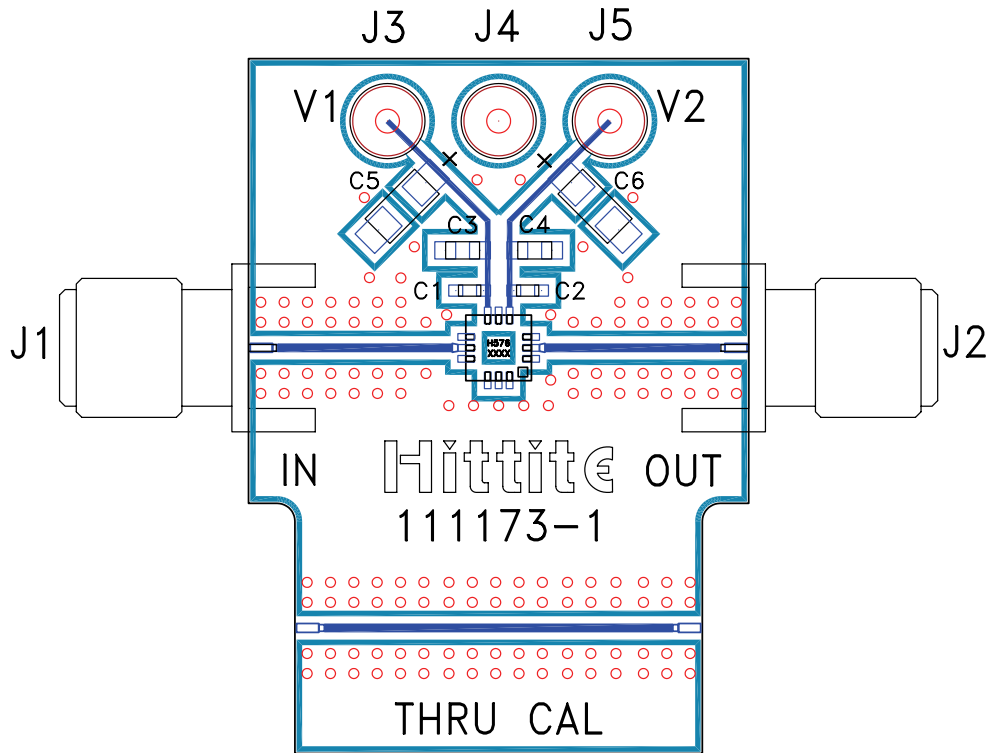

List of Materials for Evaluation PCB 112409 [1]

Item	Description
J1, J2	PCB Mount SRI K Connector
J3 - J5	DC Pin
C1, C2	100 pF Capacitor, 0402 Pkg.
C3, C4	1,000 pF Capacitor, 0603 Pkg.
C5, C6	2.2 μF Tantalum Capacitor
U1	HMC576LC3B x2 Active Multiplier
PCB [2]	111173 Eval Board

[1] Reference this number when ordering complete evaluation PCB

[2] Circuit Board Material: Rogers 4350

The circuit board used in the final application should be generated with proper RF circuit design techniques. Signal lines should have 50 ohm impedance while the package ground leads and exposed paddle should be connected directly to the ground plane similar to that shown. A sufficient number of via holes should be used to connect the top and bottom ground planes. The evaluation circuit board shown is available from Hittite upon request.



Компания «ЭлектроПласт» предлагает заключение долгосрочных отношений при поставках импортных электронных компонентов на взаимовыгодных условиях!

Наши преимущества:

- Оперативные поставки широкого спектра электронных компонентов отечественного и импортного производства напрямую от производителей и с крупнейших мировых складов;
- Поставка более 17-ти миллионов наименований электронных компонентов;
- Поставка сложных, дефицитных, либо снятых с производства позиций;
- Оперативные сроки поставки под заказ (от 5 рабочих дней);
- Экспресс доставка в любую точку России;
- Техническая поддержка проекта, помощь в подборе аналогов, поставка прототипов;
- Система менеджмента качества сертифицирована по Международному стандарту ISO 9001;
- Лицензия ФСБ на осуществление работ с использованием сведений, составляющих государственную тайну;
- Поставка специализированных компонентов (Xilinx, Altera, Analog Devices, Intersil, Interpoint, Microsemi, Aeroflex, Peregrine, Syfer, Eurofarad, Texas Instrument, Miteq, Cobham, E2V, MA-COM, Hittite, Mini-Circuits, General Dynamics и др.);

Помимо этого, одним из направлений компании «ЭлектроПласт» является направление «Источники питания». Мы предлагаем Вам помощь Конструкторского отдела:

- Подбор оптимального решения, техническое обоснование при выборе компонента;
- Подбор аналогов;
- Консультации по применению компонента;
- Поставка образцов и прототипов;
- Техническая поддержка проекта;
- Защита от снятия компонента с производства.



Как с нами связаться

Телефон: 8 (812) 309 58 32 (многоканальный)

Факс: 8 (812) 320-02-42

Электронная почта: org@eplast1.ru

Адрес: 198099, г. Санкт-Петербург, ул. Калинина, дом 2, корпус 4, литера А.