



## Chip Beads

For general signal line

GHz noise countermeasure (general signal line, high-speed signal line)

# MMZ-E series (For automobiles)

---

**MMZ1005-E**

**1005[0402 inch]\***

\* Dimensions Code JIS[EIA]

---

## REMINDERS FOR USING THESE PRODUCTS

Before using these products, be sure to request the delivery specifications.

### SAFETY REMINDERS

Please pay sufficient attention to the warnings for safe designing when using these products.

#### REMINDERS

- The storage period is less than 12 months. Be sure to follow the storage conditions (Temperature: 5 to 40°C, Humidity: 10 to 75% RH or less).  
If the storage period elapses, the soldering of the terminal electrodes may deteriorate.
- Do not use or store in locations where there are conditions such as gas corrosion (salt, acid, alkali, etc.).
- Before soldering, be sure to preheat components.  
The preheating temperature should be set so that the temperature difference between the solder temperature and chip temperature does not exceed 150°C.
- Soldering corrections after mounting should be within the range of the conditions determined in the specifications.  
If overheated, a short circuit, performance deterioration, or lifespan shortening may occur.
- When embedding a printed circuit board where a chip is mounted to a set, be sure that residual stress is not given to the chip due to the overall distortion of the printed circuit board and partial distortion such as at screw tightening portions.
- Self heating (temperature increase) occurs when the power is turned ON, so the tolerance should be sufficient for the set thermal design.
- Carefully lay out the coil for the circuit board design of the non-magnetic shield type.  
A malfunction may occur due to magnetic interference.
- Use a wrist band to discharge static electricity in your body through the grounding wire.
- Do not expose the products to magnets or magnetic fields.
- Do not use for a purpose outside of the contents regulated in the delivery specifications.
- The products listed on this catalog are intended for use in general electronic equipment (AV equipment, telecommunications equipment, home appliances, amusement equipment, computer equipment, personal equipment, office equipment, measurement equipment, industrial robots) under a normal operation and use condition.  
The products are not designed or warranted to meet the requirements of the applications listed below, whose performance and/or quality require a more stringent level of safety or reliability, or whose failure, malfunction or trouble could cause serious damage to society, person or property.  
If you intend to use the products in the applications listed below or if you have special requirements exceeding the range or conditions set forth in the each catalog, please contact us.

- (1) Aerospace/Aviation equipment
- (2) Transportation equipment (electric trains, ships, etc.)
- (3) Medical equipment
- (4) Power-generation control equipment
- (5) Atomic energy-related equipment
- (6) Seabed equipment
- (7) Transportation control equipment

- (8) Public information-processing equipment
- (9) Military equipment
- (10) Electric heating apparatus, burning equipment
- (11) Disaster prevention/crime prevention equipment
- (12) Safety equipment
- (13) Other applications that are not considered general-purpose applications

When designing your equipment even for general-purpose applications, you are kindly requested to take into consideration securing protection circuit/device or providing backup circuits in your equipment.

# Chip Beads

For general signal line

GHz noise countermeasure (general signal line, high-speed signal line)

Product compatible with RoHS directive

Halogen-free

Compatible with lead-free solders

AEC-Q200

## Overview of the MMZ-E Series

### FEATURES

- Noise reduction solution for general signal line.
- Compared to the MMZ Series, it is a product that increases the SRF to GHz bands and can countermeasure noise at wide frequencies with 1 element.
- Compared to the MMZ Series, it can attain high impedance at GHz bands.
- Various frequency characteristics with 4 materials of different features for countermeasures against everything from general signals to high-speed signals.

### APPLICATION

Various ECUs, various modules, car multimedia (telematics).

### PART NUMBER CONSTRUCTION

| Series name | L×W×T Dimensions (mm) |             | Material name | Impedance (Ω) at 100MHz |      | Characteristic type | Packaging style |        | Internal code |
|-------------|-----------------------|-------------|---------------|-------------------------|------|---------------------|-----------------|--------|---------------|
| MMZ         | 1005                  | 1.0×0.5×0.5 | S             | 601                     | 600  | E                   | T               | Taping | D25           |
|             |                       |             | A             | 102                     | 1000 |                     |                 |        |               |
|             |                       |             | D             |                         |      |                     |                 |        |               |
|             |                       |             | F             |                         |      |                     |                 |        |               |

### OPERATING TEMPERATURE RANGE, PACKAGE QUANTITY, PRODUCT WEIGHT

| Type      | Temperature range     |                      | Package quantity | Individual weight |
|-----------|-----------------------|----------------------|------------------|-------------------|
|           | Operating temperature | Storage temperature* |                  |                   |
|           | (°C)                  | (°C)                 | (pieces/reel)    | (mg)              |
| MMZ1005-E | -55 to +125           | -55 to +125          | 10,000           | 1                 |

\* The Storage temperature range is for after the circuit board is mounted.

○ RoHS Directive Compliant Product: See the following for more details related to RoHS Directive compliant products. <http://www.tdk.co.jp/rohs/>

○ Halogen-free: Indicates that Cl content is less than 900ppm, Br content is less than 900ppm, and that the total Cl and Br content is less than 1500ppm.

• All specifications are subject to change without notice.

# Overview of the MMZ-E Series

## RECOMMENDED REFLOW PROFILE

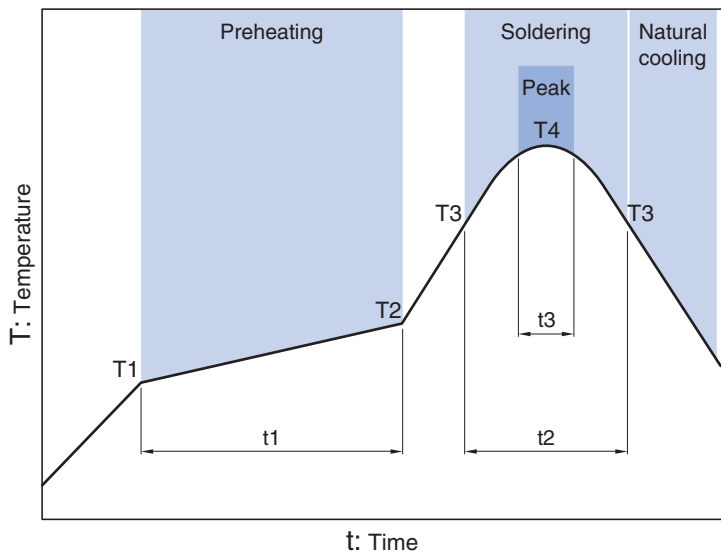

| Preheating |       |            | Soldering |           | Peak         |      |
|------------|-------|------------|-----------|-----------|--------------|------|
| Temp.      | Temp. | Time       | Temp.     | Time      | Temp.        | Time |
| T1         | T2    | t1         | T3        | t2        | T4           | t3   |
| 150°C      | 180°C | 60 to 120s | 230°C     | 30 to 60s | 250 to 260°C | 10s  |

• All specifications are subject to change without notice.

MMZ-E series

# MMZ1005-E Type



## SHAPE & DIMENSIONS

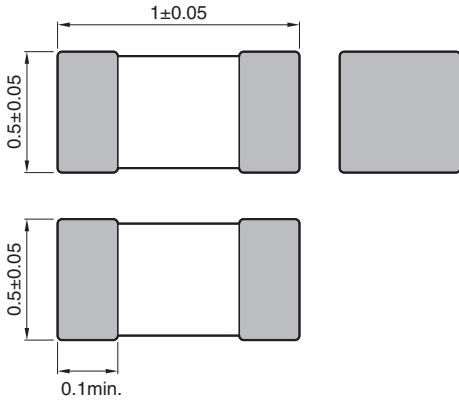

Dimensions in mm

## RECOMMENDED LAND PATTERN

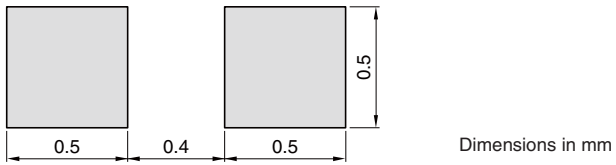

Dimensions in mm

• All specifications are subject to change without notice.

# MMZ-E series MMZ1005-E Type

## ■ ELECTRICAL CHARACTERISTICS

### □ CHARACTERISTICS SPECIFICATION TABLE

| Impedance                |            |                        |            | DC resistance<br>( $\Omega$ )max. | Rated current<br>(mA)max. | Part No.         |
|--------------------------|------------|------------------------|------------|-----------------------------------|---------------------------|------------------|
| [100MHz]<br>( $\Omega$ ) | Tolerance  | [1GHz]<br>( $\Omega$ ) | Tolerance  |                                   |                           |                  |
| 600                      | $\pm 25\%$ | 1000                   | $\pm 40\%$ | 0.65                              | 300                       | MMZ1005S601ETD25 |
| 1000                     | $\pm 25\%$ | 1400                   | $\pm 40\%$ | 1.00                              | 250                       | MMZ1005S102ETD25 |
| 1800                     | $\pm 25\%$ | 1800                   | $\pm 40\%$ | 1.50                              | 200                       | MMZ1005S182ETD25 |
| 600                      | $\pm 25\%$ | 1400                   | $\pm 40\%$ | 0.80                              | 300                       | MMZ1005A601ETD25 |
| 1000                     | $\pm 25\%$ | 2000                   | $\pm 40\%$ | 1.20                              | 250                       | MMZ1005A102ETD25 |
| 1500                     | $\pm 25\%$ | 2300                   | $\pm 40\%$ | 1.60                              | 230                       | MMZ1005A152ETD25 |
| 1800                     | $\pm 25\%$ | 2700                   | $\pm 40\%$ | 2.10                              | 200                       | MMZ1005A182ETD25 |
| 2200                     | $\pm 25\%$ | 3000                   | $\pm 40\%$ | 2.20                              | 150                       | MMZ1005A222ETD25 |
| 120                      | $\pm 25\%$ | 1000                   | $\pm 40\%$ | 0.70                              | 300                       | MMZ1005D121ETD25 |
| 220                      | $\pm 25\%$ | 1700                   | $\pm 40\%$ | 1.00                              | 250                       | MMZ1005D221ETD25 |
| 47                       | $\pm 25\%$ | 800                    | $\pm 40\%$ | 0.70                              | 300                       | MMZ1005F470ETD25 |
| 75                       | $\pm 25\%$ | 1500                   | $\pm 40\%$ | 1.00                              | 250                       | MMZ1005F750ETD25 |
| 120                      | $\pm 25\%$ | 2300                   | $\pm 40\%$ | 1.50                              | 200                       | MMZ1005F121ETD25 |

### ○ Measurement equipment

| Measurement item | Product No.   | Manufacturer         |
|------------------|---------------|----------------------|
| Impedance        | E4991A+16192A | Agilent Technologies |
| DC resistance    | Type-7556     | Yokogawa             |

\* Equivalent measurement equipment may be used.

# MMZ-E series **MMZ1005-E Type**

## ■ ELECTRICAL CHARACTERISTICS

### □ Z VS. FREQUENCY CHARACTERISTICS (BY SERIES)

**MMZ1005S-E SERIES**

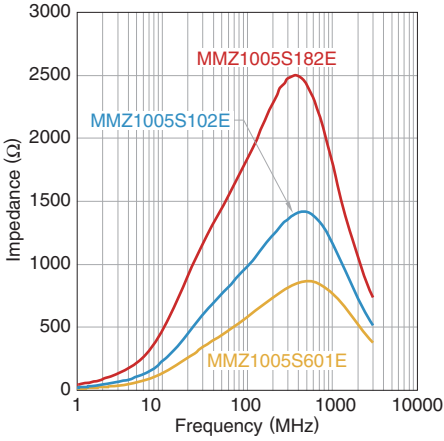

**MMZ1005A-E SERIES**

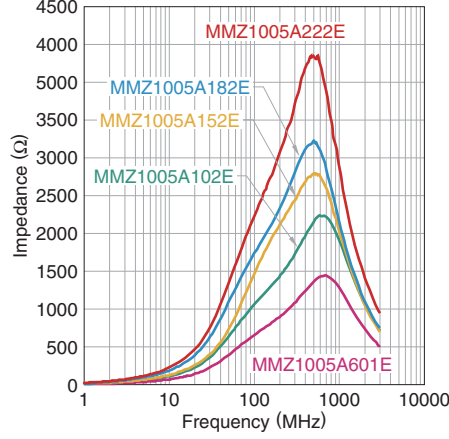

**MMZ1005D-E SERIES**

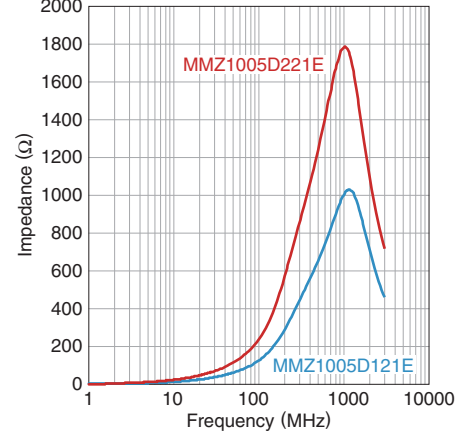

**MMZ1005F-E SERIES**

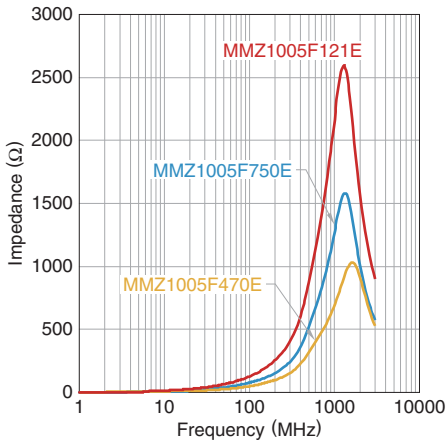

• All specifications are subject to change without notice.

# MMZ-E series MMZ1005-E Type

## ELECTRICAL CHARACTERISTICS

### Z, X, R VS. FREQUENCY CHARACTERISTICS

MMZ1005S601ETD25

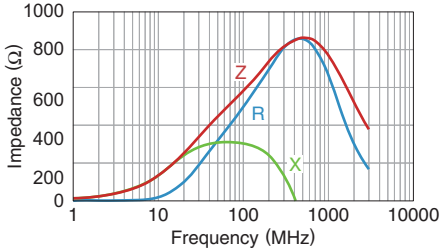

MMZ1005S102ETD25

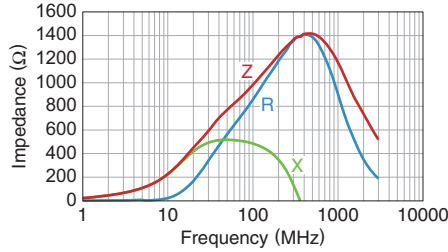

MMZ1005S182ETD25

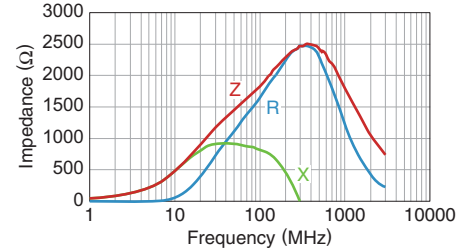

MMZ1005A601ETD25

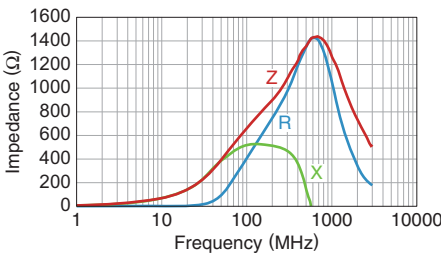

MMZ1005A102ETD25

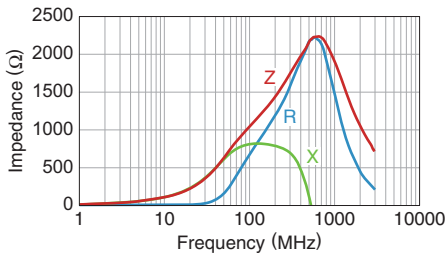

MMZ1005A152ETD25

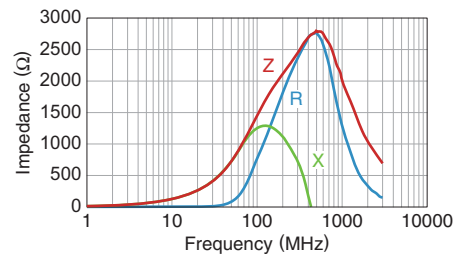

MMZ1005A182ETD25

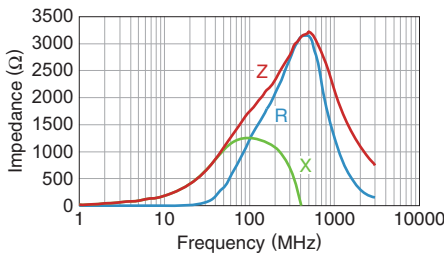

MMZ1005A222ETD25

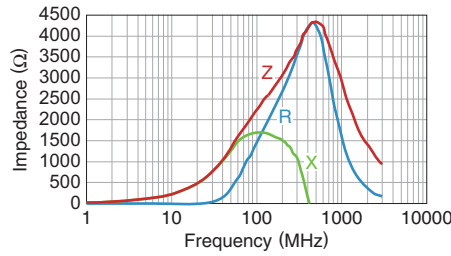

MMZ1005D121ETD25

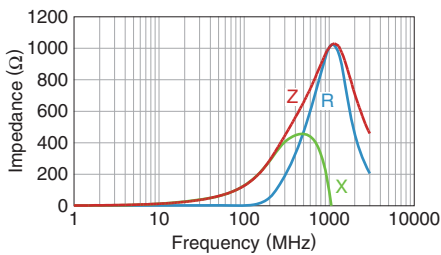

MMZ1005D221ETD25

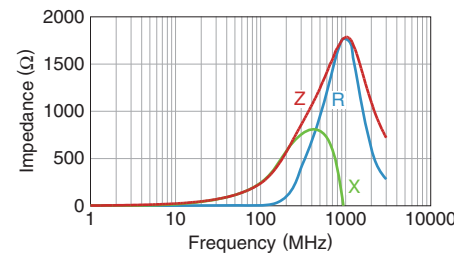

MMZ1005F470ETD25

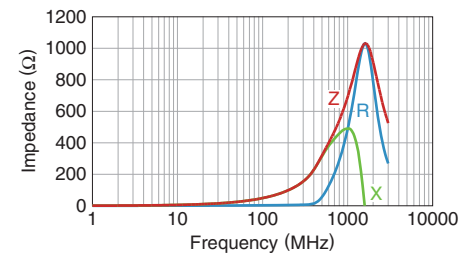

MMZ1005F750ETD25

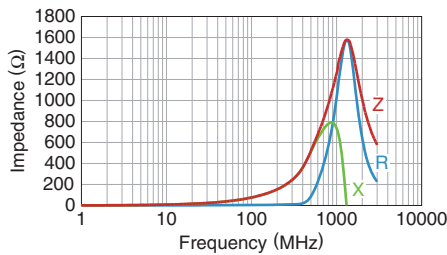

MMZ1005F121ETD25

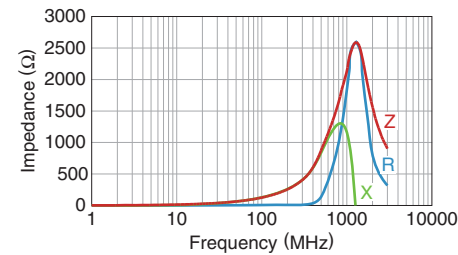

• All specifications are subject to change without notice.



# MMZ-E series

# Packaging style

## REEL DIMENSIONS

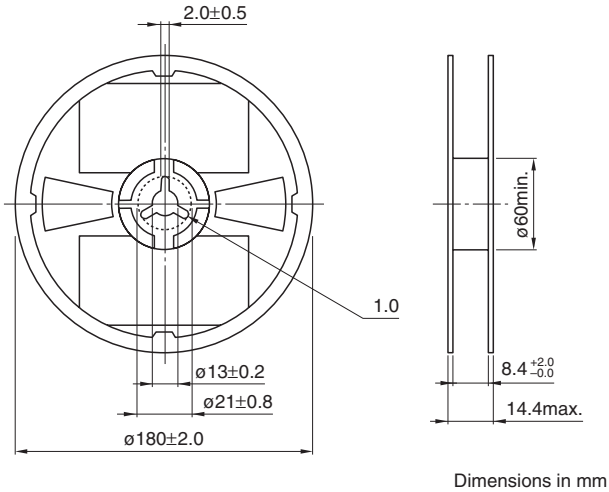

Dimensions in mm

## TAPE DIMENSIONS

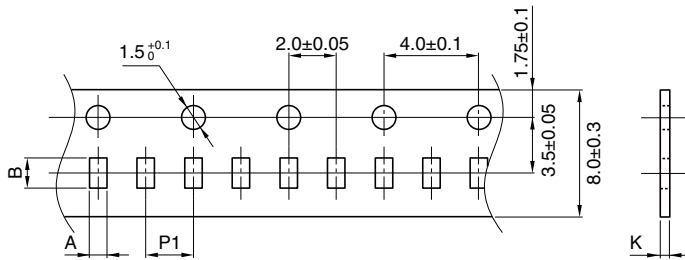

Dimensions in mm

| Type      | A        | B        | P1       | K       |
|-----------|----------|----------|----------|---------|
| MMZ1005-E | 0.65±0.1 | 1.15±0.1 | 2.0±0.05 | 0.8max. |

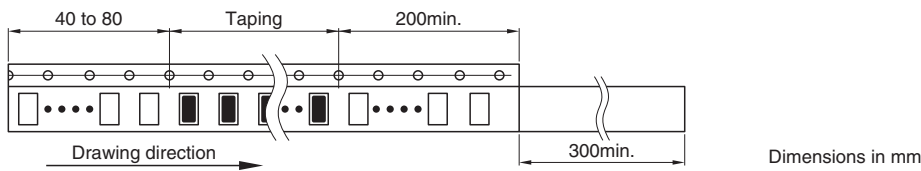

Dimensions in mm

• All specifications are subject to change without notice.



Компания «ЭлектроПласт» предлагает заключение долгосрочных отношений при поставках импортных электронных компонентов на взаимовыгодных условиях!

Наши преимущества:

- Оперативные поставки широкого спектра электронных компонентов отечественного и импортного производства напрямую от производителей и с крупнейших мировых складов;
- Поставка более 17-ти миллионов наименований электронных компонентов;
- Поставка сложных, дефицитных, либо снятых с производства позиций;
- Оперативные сроки поставки под заказ (от 5 рабочих дней);
- Экспресс доставка в любую точку России;
- Техническая поддержка проекта, помощь в подборе аналогов, поставка прототипов;
- Система менеджмента качества сертифицирована по Международному стандарту ISO 9001;
- Лицензия ФСБ на осуществление работ с использованием сведений, составляющих государственную тайну;
- Поставка специализированных компонентов (Xilinx, Altera, Analog Devices, Intersil, Interpoint, Microsemi, Aeroflex, Peregrine, Syfer, Eurofarad, Texas Instrument, Miteq, Cobham, E2V, MA-COM, Hittite, Mini-Circuits, General Dynamics и др.);

Помимо этого, одним из направлений компании «ЭлектроПласт» является направление «Источники питания». Мы предлагаем Вам помощь Конструкторского отдела:

- Подбор оптимального решения, техническое обоснование при выборе компонента;
- Подбор аналогов;
- Консультации по применению компонента;
- Поставка образцов и прототипов;
- Техническая поддержка проекта;
- Защита от снятия компонента с производства.



#### Как с нами связаться

**Телефон:** 8 (812) 309 58 32 (многоканальный)

**Факс:** 8 (812) 320-02-42

**Электронная почта:** [org@eplast1.ru](mailto:org@eplast1.ru)

**Адрес:** 198099, г. Санкт-Петербург, ул. Калинина, дом 2, корпус 4, литера А.