

CQHS250

CQH S 250 48 50 -□

① ② ③ ④ ⑤ ⑥

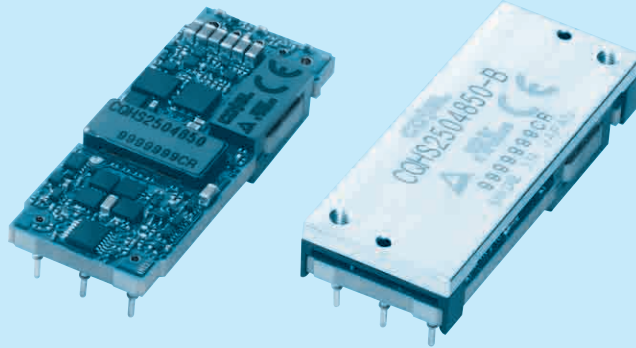
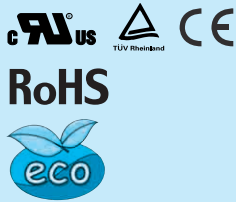

- ① Series name
- ② Single output
- ③ Output wattage
- ④ Input voltage
48:DC36 - 76V
- ⑤ Output voltage
- ⑥ Optional
- R :with Remote ON/OFF
Positive logic control
- N :Auto restart in protection
circuit working
- B :Base plate option with
Mounting hole M3
- L2:Pin length 5.3mm

MODEL	CQHS2504832	CQHS2504850
MAX OUTPUT WATTAGE[W]	252.8	250
DC OUTPUT	32V 7.9A	50V 5.0A

SPECIFICATIONS

	MODEL	CQHS2504832	CQHS2504850	
INPUT	VOLTAGE[V]	DC36 - 76		
	CURRENT[A]	*1 5.60typ	5.54typ	
	EFFICIENCY[%]	*1 94typ	94typ	
	START-UP VOLTAGE[V]	DC32 - 36		
	HYSTERESIS VOLTAGE[V]	DC2 min		
OUTPUT	VOLTAGE[V]	32	50	
	CURRENT[A]	7.9	5.0	
	LINE REGULATION[mV]	64max	100max	
	LOAD REGULATION[mV]	64max	100max	
	RIPPLE[mVp-p]	-20 to +85°C Vin=36-60V *2	255max	400max
		-20 to +85°C Vin=60-76V *2	320max	500max
		-40 to -20°C *2	320max	500max
	RIPPLE NOISE[mVp-p]	-20 to +85°C *2	320max	500max
		-40 to -20°C *2	410max	650max
	TEMPERATURE REGULATION[mV]	-40 to +85°C	640max	1000max
DRIFT[mV]	*3	120max	185max	
START-UP TIME[ms]	200max (DCIN 48V, Io=100%)			
OUTPUT VOLTAGE ADJUSTMENT RANGE[V] *4	Fixed (TRM pin open), adjustable by external resistor			
	26.88 - 35.20	45.0 - 55.0		
OUTPUT VOLTAGE SETTING[V] *1	31.68 - 32.32	49.50 - 50.50		
PROTECTION CIRCUIT AND OTHERS	OVERCURRENT PROTECTION	Works over 105% of rating, low voltage protection (shut down) function is built-in.		
	OVERVOLTAGE PROTECTION[V]	36.80 - 44.80	56.50 - 67.50	
	REMOTE SENSING	Provided		
	REMOTE ON/OFF	Provided (Negative Logic L : ON, H :OFF)		
ISOLATION	INPUT-OUTPUT	DC1,500V or AC500V 1minute, Cutoff current = 10mA, DC500V 50MΩ min (20±15°C)		
	INPUT-BASE PLATE *5	DC1,500V or AC500V 1minute, Cutoff current = 10mA, DC500V 50MΩ min (20±15°C)		
	OUTPUT-BASE PLATE *5	AC500V 1minute, Cutoff current = 100mA, DC500V 50MΩ min (20±15°C)		
ENVIRONMENT	OPERATING TEMP.,HUMID.AND ALTITUDE	-40 to +85°C, 20 - 95%RH (Non condensing) (Refer to DERATING CURVE), 3,000m (10,000 feet) max		
	STORAGE TEMP.,HUMID.AND ALTITUDE	-40 to +100°C, 20 - 95%RH (Non condensing), 9,000m (30,000 feet) max		
	VIBRATION	10 - 55Hz, 49.0m/s ² (5G), 3minutes period, 60minutes each along X, Y and Z axis		
	IMPACT	196.1m/s ² (20G), 11ms, once each along X, Y and Z axis		
SAFETY	AGENCY APPROVALS	UL60950-1, C-UL (CSA60950-1), EN60950-1		
OTHERS	CASE SIZE/WEIGHT	57.9 × 10.5 × 22.76mm [2.28 × 0.41 × 0.9 inches] (W × H × D) / 30g max		
		58.4 × 12.7 × 23.26mm [2.3 × 0.5 × 0.92 inches] (W × H × D) / 45g max *5		
	COOLING METHOD	Convection / Forced air / Conduction		

*1 At rated input(DC48V), rated load. Ta= 25°C, 2m/s.
 *2 Ripple and ripple noise is measured by using measuring board. Refer to the manual.
 *3 Drift is the change in DC output for an eight hour period after a half-hour warm-up at 25°C, with the input voltage held constant at the rated input/output.
 *4 When the input voltage is in the range of DC36-40V, output voltage is limited. Refer to the manual.
 *5 Base Plate Option.

External view

1. DIP

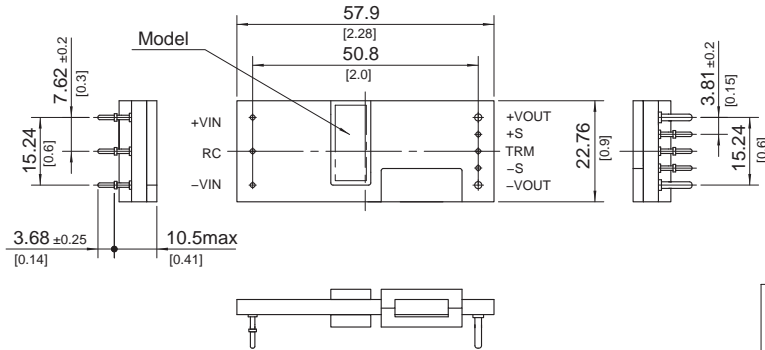

- ※ Tolerance : ±0.5 [±0.02]
- ※ Weight : 30g max(DIP)
45g max(Base Plate)
- ※ Dimensions in mm, []=inches

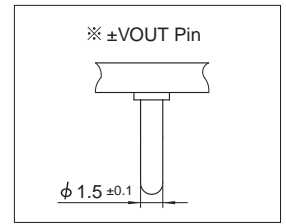
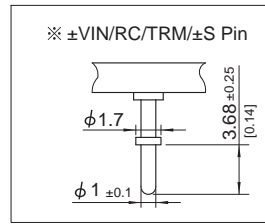

2. Base Plate (option B)

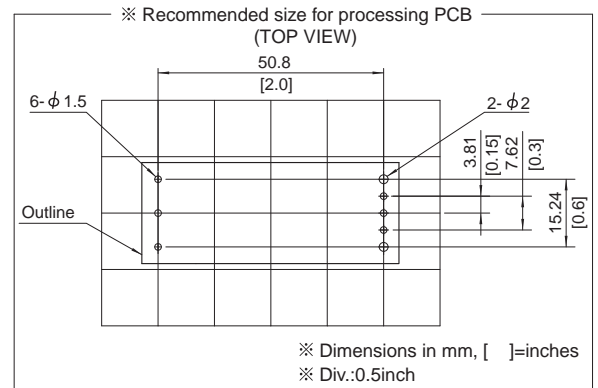
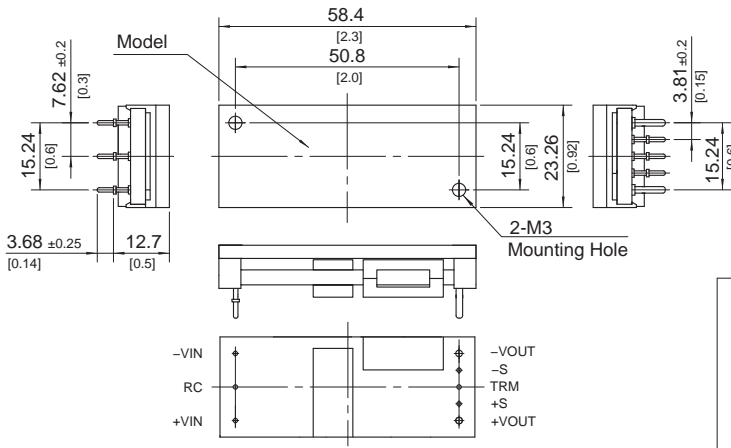

CQHS300

CQH S 300 48 50 -□
 ① ② ③ ④ ⑤ ⑥

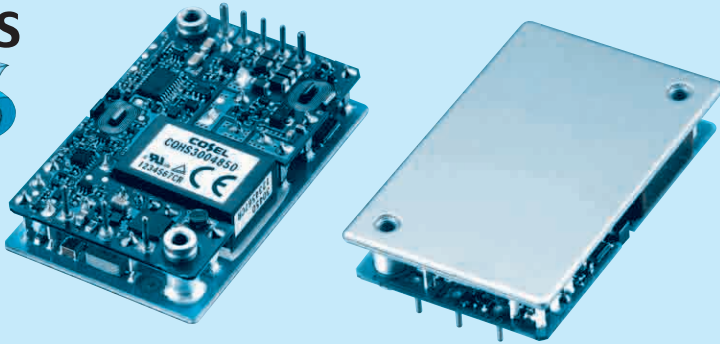
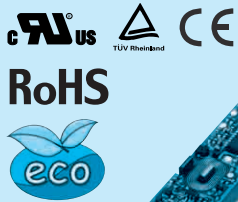

*Providing heat sink as option

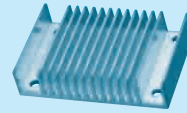

- ① Series name
- ② Single output
- ③ Output wattage
- ④ Input voltage
48:DC36 - 76V
- ⑤ Output voltage
- ⑥ Optional
- R :with Remote ON/OFF
Positive logic control
- T :with Mounting hole
φ 3.4 thru

MODEL	CQHS3004832	CQHS3004850
MAX OUTPUT WATTAGE[W]	300.8	300
DC OUTPUT	32V 9.4A	50V 6A

SPECIFICATIONS

	MODEL	CQHS3004832	CQHS3004850	
INPUT	VOLTAGE[V]	DC36 - 76		
	CURRENT[A]	6.67typ	6.65typ	
	EFFICIENCY[%]	94typ	94typ	
	START-UP VOLTAGE[V]	DC32 - 36		
	HYSTERESIS VOLTAGE[V]	DC2 min		
OUTPUT	VOLTAGE[V]	32	50	
	CURRENT[A]	9.4	6.0	
	LINE REGULATION[mV]	64max	100max	
	LOAD REGULATION[mV]	64max	100max	
	RIPPLE[mVp-p]	-20 to +100°C *2	255max	400max
		-40 to -20°C Vin=36-60V *2	320max	500max
		-40 to -20°C Vin=60-76V *2	400max	500max
	RIPPLE NOISE[mVp-p]	-20 to +100°C *2	320max	500max
		-40 to -20°C *2	410max	650max
	TEMPERATURE REGULATION[mV]	0 to +65°C	320max	500max
		-40 to +100°C	640max	1000max
	DRIFT[mV]	*3	120max	185max
	START-UP TIME[ms]		200max (DCIN 48V, Io=100%)	
OUTPUT VOLTAGE ADJUSTMENT RANGE[V] *4		Fixed (TRM pin open), adjustable by external resistor		
		27.2 - 35.2	45.0 - 55.0	
	OUTPUT VOLTAGE SETTING[V]*	31.68 - 32.32	49.50 - 50.50	
PROTECTION CIRCUIT AND OTHERS	OVERCURRENT PROTECTION	Works over 105% of rating, low voltage protection (shut down) function is built-in.		
	OVERVOLTAGE PROTECTION[V]	36.80 - 44.80	56.50 - 67.50	
	REMOTE SENSING	Provided		
	REMOTE ON/OFF	Provided (Negative Logic L : ON, H :OFF)		
ISOLATION	INPUT-OUTPUT	DC1,500V or AC500V 1minute, Cutoff current = 10mA, DC500V 50MΩ min (20±15°C)		
	INPUT-BASE PLATE	DC1,500V or AC500V 1minute, Cutoff current = 10mA, DC500V 50MΩ min (20±15°C)		
	OUTPUT-BASE PLATE	AC500V 1minute, Cutoff current = 100mA, DC500V 50MΩ min (20±15°C)		
ENVIRONMENT	OPERATING TEMP., HUMID. AND ALTITUDE	-40 to +100°C (On aluminum base plate), 20 - 95%RH (Non condensing) (Refer to DERATING CURVE), 3,000m (10,000 feet) max		
	STORAGE TEMP., HUMID. AND ALTITUDE	-40 to +100°C, 20 - 95%RH (Non condensing), 9,000m (30,000 feet) max		
	VIBRATION	10 - 55Hz, 49.0m/s ² (5G), 3minutes period, 60minutes each along X, Y and Z axis		
	IMPACT	196.1m/s ² (20G), 11ms, once each along X, Y and Z axis		
SAFETY	AGENCY APPROVALS	UL60950-1, C-UL (CSA60950-1), EN60950-1		
OTHERS	CASE SIZE/WEIGHT	57.9×12.7×36.8mm [2.28×0.5×1.45 inches] (W×H×D) / 75g max		
	COOLING METHOD	Conduction cooling (e.g. heat radiation from the aluminum base plate to the attached heat sink)		

*1 At rated input(DC48V), rated load, and aluminum base plate temperature 25°C.
 *2 Ripple and ripple noise is measured by using measuring board with recommended capacitor Co & the film capacitor 0.1 μF.
 *3 Drift is the change in DC output for an eight hour period after a half-hour warm-up at 25°C, with the input voltage held constant at the rated input/output.
 *4 When the input voltage is in the range of DC36-40V, output voltage is limited. Refer to the manual.

External view

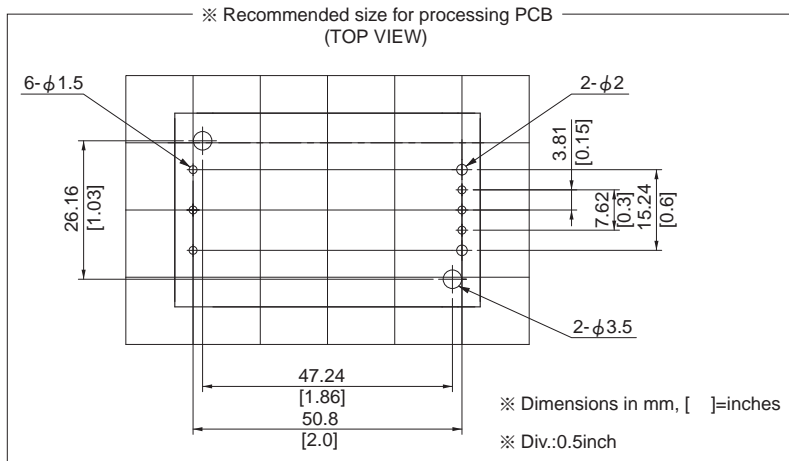
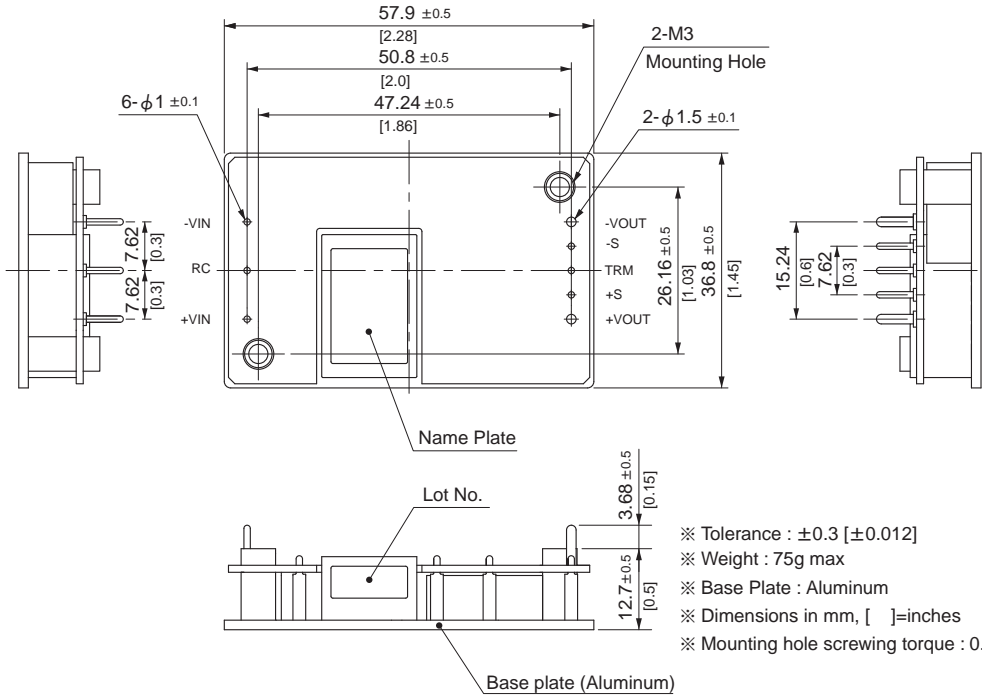

CQHS350

CQH S 350 48 50 -□

① ② ③ ④ ⑤ ⑥

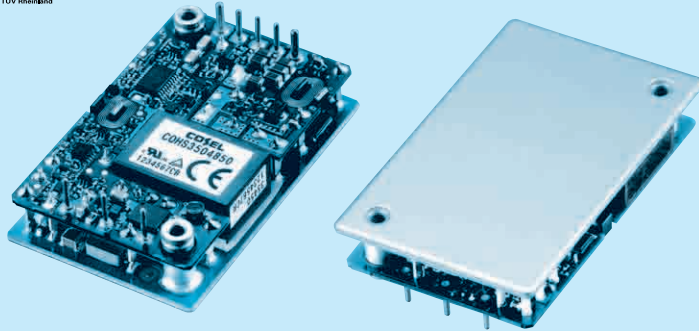
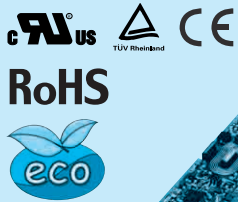

*Providing heat sink as option

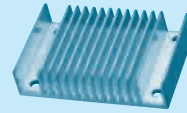

- ① Series name
- ② Single output
- ③ Output wattage
- ④ Input voltage
48:DC36 - 65V
- ⑤ Output voltage
- ⑥ Optional
- R :with Remote ON/OFF
Positive logic control
- T :with Mounting hole
φ 3.4 thru

MODEL	CQHS3504832	CQHS3504850
MAX OUTPUT WATTAGE[W]	352	350
DC OUTPUT	32V 11A	50V 7A

SPECIFICATIONS

	MODEL	CQHS3504832	CQHS3504850	
INPUT	VOLTAGE[V]	DC36 - 65		
	CURRENT[A]	7.8typ	7.76typ	
	EFFICIENCY[%]	94typ	94typ	
	START-UP VOLTAGE[V]	DC32 - 36		
	HYSTERESIS VOLTAGE[V]	DC2 min		
OUTPUT	VOLTAGE[V]	32	50	
	CURRENT[A]	11.0 *5	7.0	
	LINE REGULATION[mV]	64max	100max	
	LOAD REGULATION[mV]	64max	100max	
	RIPPLE[mVp-p]	-20 to +100°C *2	255max	400max
		-40 to -20°C Vin=36-60V *2	320max	500max
		-40 to -20°C Vin=60-65V *2	400max	500max
	RIPPLE NOISE[mVp-p]	-20 to +100°C *2	320max	500max
		-40 to -20°C *2	410max	650max
	TEMPERATURE REGULATION[mV]	0 to +65°C	320max	500max
		-40 to +100°C	640max	1000max
	DRIFT[mV]	*3	120max	185max
START-UP TIME[ms]	200max (DCIN 48V, Io=100%)			
OUTPUT VOLTAGE ADJUSTMENT RANGE[V] *4	Fixed (TRM pin open), adjustable by external resistor			
	26.88 - 35.20			
	45.0 - 55.0			
OUTPUT VOLTAGE SETTING[V] *5	31.68 - 32.32	49.50 - 50.50		
PROTECTION CIRCUIT AND OTHERS	OVERCURRENT PROTECTION	Works over 105% of rating, low voltage protection (shut down) function is built-in.		
	OVERVOLTAGE PROTECTION[V]	36.80 - 44.80	56.50 - 67.50	
	REMOTE SENSING	Provided		
	REMOTE ON/OFF	Provided (Negative Logic L : ON, H :OFF)		
ISOLATION	INPUT-OUTPUT	DC1,500V or AC500V 1minute, Cutoff current = 10mA, DC500V 50MΩ min (20±15°C)		
	INPUT-BASE PLATE	DC1,500V or AC500V 1minute, Cutoff current = 10mA, DC500V 50MΩ min (20±15°C)		
	OUTPUT-BASE PLATE	AC500V 1minute, Cutoff current = 100mA, DC500V 50MΩ min (20±15°C)		
ENVIRONMENT	OPERATING TEMP.,HUMID.AND ALTITUDE	-40 to +100°C (On aluminum base plate), 20 - 95%RH (Non condensing) (Refer to DERATING CURVE), 3,000m (10,000 feet) max		
	STORAGE TEMP.,HUMID.AND ALTITUDE	-40 to +100°C, 20 - 95%RH (Non condensing), 9,000m (30,000 feet) max		
	VIBRATION	10 - 55Hz, 49.0m/s ² (5G), 3minutes period, 60minutes each along X, Y and Z axis		
	IMPACT	196.1m/s ² (20G), 11ms, once each along X, Y and Z axis		
SAFETY	AGENCY APPROVALS	UL60950-1, C-UL (CSA60950-1), EN60950-1		
OTHERS	CASE SIZE/WEIGHT	57.9×12.7×36.8mm [2.28×0.5×1.45 inches] (W×H×D) / 75g max		
	COOLING METHOD	Conduction cooling (e.g. heat radiation from the aluminum base plate to the attached heat sink)		

*1 At rated input(DC48V), rated load, and aluminum base plate temperature 25°C.
 *2 Ripple and ripple noise is measured by using measuring board with recommended capacitor Co & the film capacitor 0.1 μF.
 *3 Drift is the change in DC output for an eight hour period after a half-hour warm-up at 25°C, with the input voltage held constant at the rated input/output.
 *4 When the input voltage is in the range of DC36-40V, output voltage is limited. Refer to the manual.
 *5 Rated current is increased adjusting output voltage to lower than rated output voltage. Refer to the manual.

External view

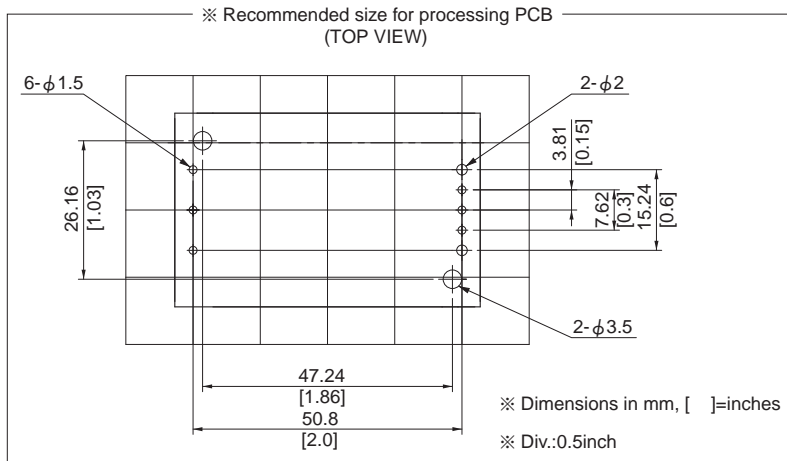
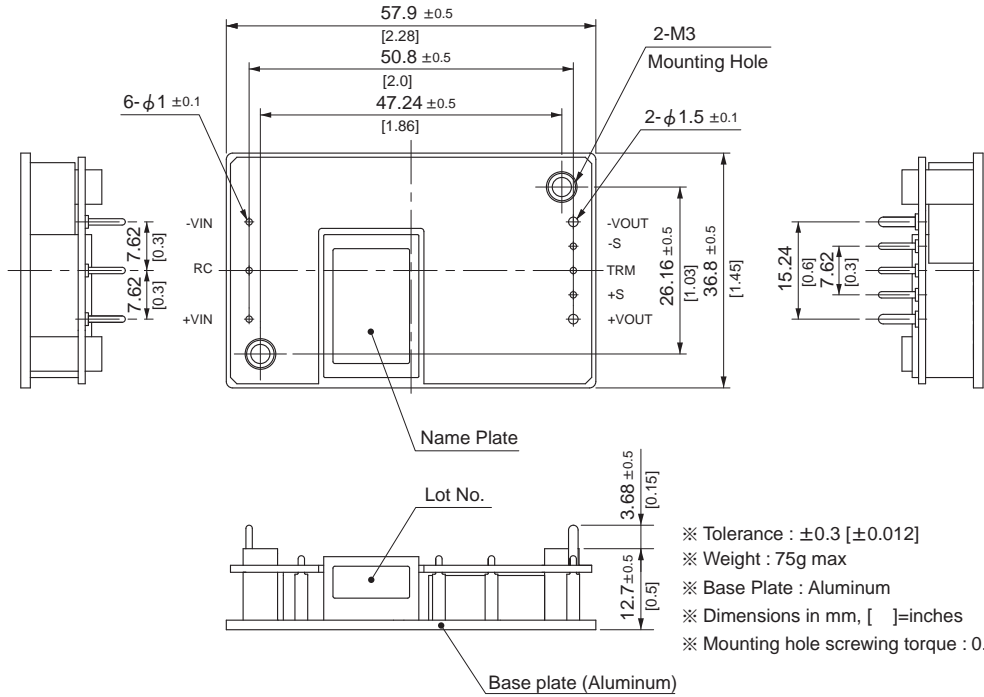

Mouser Electronics

Authorized Distributor

Click to View Pricing, Inventory, Delivery & Lifecycle Information:

Cosel:

[CQHS3004850-T](#) [CQHS3004832](#) [CQHS3004832-T](#) [CQHS3004832-RT](#) [CQHS3004850-R](#) [CQHS3004850-RT](#)
[CQHS3004850](#) [CQHS3004832-R](#)



Компания «ЭлектроПласт» предлагает заключение долгосрочных отношений при поставках импортных электронных компонентов на взаимовыгодных условиях!

Наши преимущества:

- Оперативные поставки широкого спектра электронных компонентов отечественного и импортного производства напрямую от производителей и с крупнейших мировых складов;
- Поставка более 17-ти миллионов наименований электронных компонентов;
- Поставка сложных, дефицитных, либо снятых с производства позиций;
- Оперативные сроки поставки под заказ (от 5 рабочих дней);
- Экспресс доставка в любую точку России;
- Техническая поддержка проекта, помощь в подборе аналогов, поставка прототипов;
- Система менеджмента качества сертифицирована по Международному стандарту ISO 9001;
- Лицензия ФСБ на осуществление работ с использованием сведений, составляющих государственную тайну;
- Поставка специализированных компонентов (Xilinx, Altera, Analog Devices, Intersil, Interpoint, Microsemi, Aeroflex, Peregrine, Syfer, Eurofarad, Texas Instrument, Miteq, Cobham, E2V, MA-COM, Hittite, Mini-Circuits, General Dynamics и др.);

Помимо этого, одним из направлений компании «ЭлектроПласт» является направление «Источники питания». Мы предлагаем Вам помощь Конструкторского отдела:

- Подбор оптимального решения, техническое обоснование при выборе компонента;
- Подбор аналогов;
- Консультации по применению компонента;
- Поставка образцов и прототипов;
- Техническая поддержка проекта;
- Защита от снятия компонента с производства.



Как с нами связаться

Телефон: 8 (812) 309 58 32 (многоканальный)

Факс: 8 (812) 320-02-42

Электронная почта: org@eplast1.ru

Адрес: 198099, г. Санкт-Петербург, ул. Калинина, дом 2, корпус 4, литера А.