



Main

Range of product	OsiSense XS
Series name	General purpose
Sensor type	Inductive proximity sensor
Device application	-
Sensor name	XS4
Sensor design	Cylindrical M18
Size	62 mm
Body type	Fixed
Detector flush mounting acceptance	Non flush mountable
Material	Plastic
Type of output signal	Discrete
Wiring technique	2-wire
[Sn] nominal sensing distance	0.31 in (8 mm)
Discrete output function	1 NC
Output circuit type	AC/DC
Electrical connection	Cable
Cable length	6.56 ft (2 m)
[Us] rated supply voltage	24...240 V AC/DC, 50/60 Hz
Switching capacity in mA	5...200 mA DC 5...300 mA AC
IP degree of protection	IP68 double insulation conforming to IEC 60529

Complementary

Thread type	M18 x 1
Detection face	Frontal
Front material	PPS
Enclosure material	PPS
Operating zone	0...0.25 in (0...6.4 mm)
Differential travel	1...15% of Sr
Cable composition	2 x 0.34 mm ²
Wire insulation material	PvR
Status LED	1 LED (yellow) output state
Supply voltage limits	20...264 V AC/DC
Residual current	<= 0.6 mA (open state)
Switching frequency	<= 2000 Hz (DC) <= 25 Hz (AC)
Voltage drop	<= 5.5 V (closed)
Delay first up	<= 40 ms
Delay response	<= 0.2 ms
Delay recovery	<= 0.2 ms
Marking	CE
Threaded length	2.05 in (52 mm)
Height	0.71 in (18 mm)
Length	2.44 in (62 mm)
Product weight	0.22 lb(US) (0.1 kg)

The information provided in this documentation contains general descriptions and/or technical characteristics of the products contained herein. This documentation is not intended as a substitute for and is not to be used for determining suitability or reliability of these products for specific user applications. It is the duty of any such user or integrator to perform the appropriate and complete risk analysis, evaluation and testing of the products with respect to the relevant specific application or use thereof. Neither Schneider Electric Industries SAS nor any of its affiliates or subsidiaries shall be responsible or liable for misuse of the information contained herein.

Environment

product certifications	CCC CSA UL Ecolab
ambient air temperature for operation	-13...158 °F (-25...70 °C)
ambient air temperature for storage	-40...185 °F (-40...85 °C)
vibration resistance	25 gn, amplitude: +/- 2 mm (f = 10...55 Hz) conforming to IEC 60068-2-6
shock resistance	50 gn (duration = 11 ms) conforming to IEC 60068-2-27

Offer Sustainability

Green Premium product	Green Premium product
Compliant - since 0814 - Schneider Electric declaration of conformity	Compliant - since 0814 - Schneider Electric declaration of conformity
Reference not containing SVHC above the threshold	Reference not containing SVHC above the threshold
Available	Available
Available	Available
WARNING: This product can expose you to chemicals including:	WARNING: This product can expose you to chemicals including:
Diisononyl phthalate (DINP), which is known to the State of California to cause cancer, and	Diisononyl phthalate (DINP), which is known to the State of California to cause cancer, and
Di-isodecyl phthalate (DIDP), which is known to the State of California to cause birth defects or other reproductive harm.	Di-isodecyl phthalate (DIDP), which is known to the State of California to cause birth defects or other reproductive harm.
For more information go to www.p65warnings.ca.gov	For more information go to www.p65warnings.ca.gov

Contractual warranty

Warranty period	18 months
-----------------	-----------

Dimensions

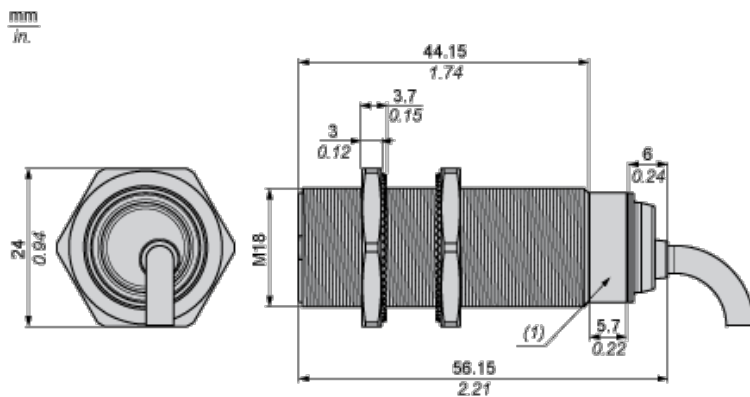

(1) LED

Minimum Mounting Distances

Side by side

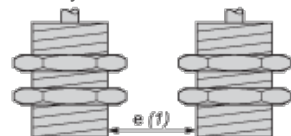

e (1) 32 mm/1.26 in.

≥

Face to face

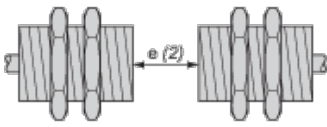

e (2) 96 mm/3.78 in.

≧

Facing a metal object

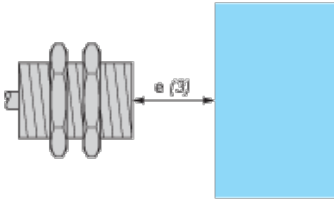

e (3) 24 mm/0.94 in.

≧

Mounted in a metal support

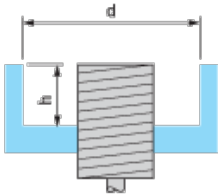

d ≥ 56 mm/2.20 in.

h ≥ 16 mm/0.63 in.

Mounting

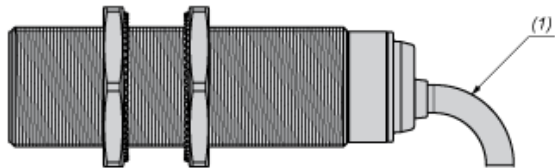

(1) Bending cable: 4 x external cable diameter

Wiring Schemes

2-Wire AC or DC

NC output

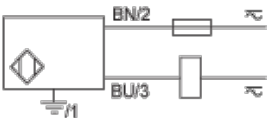

BU : Blue

BN : Brown

Performance Curves

Standard Steel Target : 24x24x1 mm

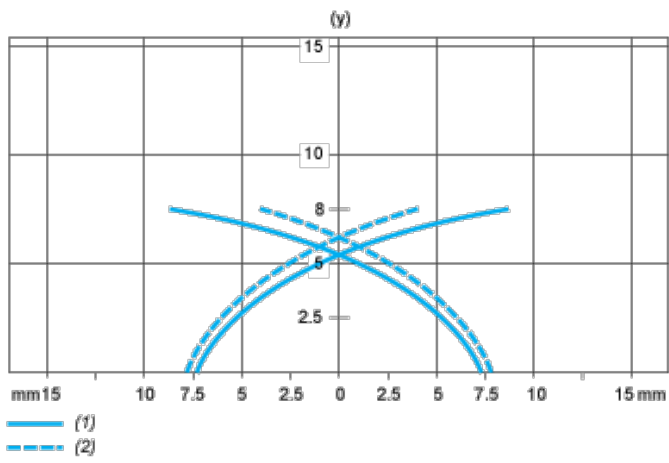

- (1) Pick-up points
- (2) Drop-out points (object approaching from the side)
- (y) Sensing distance in mm



Компания «ЭлектроПласт» предлагает заключение долгосрочных отношений при поставках импортных электронных компонентов на взаимовыгодных условиях!

Наши преимущества:

- Оперативные поставки широкого спектра электронных компонентов отечественного и импортного производства напрямую от производителей и с крупнейших мировых складов;
- Поставка более 17-ти миллионов наименований электронных компонентов;
- Поставка сложных, дефицитных, либо снятых с производства позиций;
- Оперативные сроки поставки под заказ (от 5 рабочих дней);
- Экспресс доставка в любую точку России;
- Техническая поддержка проекта, помощь в подборе аналогов, поставка прототипов;
- Система менеджмента качества сертифицирована по Международному стандарту ISO 9001;
- Лицензия ФСБ на осуществление работ с использованием сведений, составляющих государственную тайну;
- Поставка специализированных компонентов (Xilinx, Altera, Analog Devices, Intersil, Interpoint, Microsemi, Aeroflex, Peregrine, Syfer, Eurofarad, Texas Instrument, Miteq, Cobham, E2V, MA-COM, Hittite, Mini-Circuits, General Dynamics и др.);

Помимо этого, одним из направлений компании «ЭлектроПласт» является направление «Источники питания». Мы предлагаем Вам помощь Конструкторского отдела:

- Подбор оптимального решения, техническое обоснование при выборе компонента;
- Подбор аналогов;
- Консультации по применению компонента;
- Поставка образцов и прототипов;
- Техническая поддержка проекта;
- Защита от снятия компонента с производства.



Как с нами связаться

Телефон: 8 (812) 309 58 32 (многоканальный)

Факс: 8 (812) 320-02-42

Электронная почта: org@eplast1.ru

Адрес: 198099, г. Санкт-Петербург, ул. Калинина, дом 2, корпус 4, литера А.