



INVENTEK SYSTEMS
ISM43362-L36
Wi-Fi SiP Module
eS-WiFi™
802.11 b/g/n
Data Sheet



Table of Contents

1	General Description	3
2	Part Number Description	4
3	General Features	4
4	Specifications	5
4.1	Module Architecture / Block Diagram	5
5	Limitations	6
5.1	Regulatory Compliance	6
5.2	FCC and IC User’s Manual Statements:.....	6
5.3	Industry Canada User’s Manual Statements:	8
6	Complementary Documentation	9
6.1	Inventek Systems	9
6.2	Environmental Specifications	9
7	Electrical Specifications.....	9
7.1	Recommended Operating Ratings	9
8	Power Consumption.....	10
9	Wi-Fi RF Specification	10
9.1	RF Specification.....	10
9.2	802.11b Transmit	12
9.3	802.11g Transmit	13
9.4	802.11n Transmit	13
9.5	802.11b Receiver	14
9.6	802.11g Receiver	14
9.7	802.11n Receiver	15
10	Footprint.....	18
11	PCB Layout (Top View).....	19
12	Boot Sequence	20
13	Communications Interfaces	21
13.1	SDIO and gSPI CONFIGURATION.....	21
13.2	SDIO Timing (Default Mode)	22
13.3	SDIO Timing (High Speed Mode).....	23
13.4	gSPI Interface Characteristics.....	24
13.5	PCB Etch Antenna Gain on the Evaluation Board	25
13.6	Farfield Directivity.....	26
14	27
14.1	External Antenna Option	27
15	Product Compliance Considerations.....	28
16	Reflow Profile.....	29
17	Packaging Information.....	30
17.1	MSL Level / Storage Condition.....	30
17.2	Device baking requirements prior to assembly.....	31
	Module’s Assembly Instructions	31
18	Contact Information	32

1 General Description

The Inventek ISM43362-L36 is an 802.11 b/g/n WiFi Radio SiP with on board antenna or optional external antenna with a U.FL connector, which is designed for embedded wireless solutions and offers a cost-effective high performance Broadcom radio device (BCM43362) packaged in an 36 pin LGA (24.4mm x 15.3 mm). It includes standards-based wired and wireless technologies to enable IP infrastructures for smart grid, smart home, security, building automation, toys, robots, remote health and wellness monitoring and other IoT and M2M applications.

The module is based on IEEE802.11 b/g/n antenna single-stream align technology. The solution is FCC/IC/CE certified and helps to reduce development time, lower manufacturing costs, save board space, and ease certification.

Summary of Key Features:

- 802.11 b/g/n compliant based on Broadcom MAC/Baseband/Radio device.
- SDIO v2.0
- On-chip functionality Single-chip: MAC/BB/RF
- Frequency Band: 2.4 GHz
- Network Standard: 802.11b, 802.11g, 802.11n (single stream)
- Modulation Modes: CCK and OFDM with BPSK, QPSK, 16 QAM, 64QAM
- Hardware Encryption: WEP, WPA/WPA2
- Supported Data Rates: IEEE 802.11b 1 – 11 Mbps
IEEE 802.11g 6 – 54 Mbps
IEEE 802.11n (2.4 GHz) 7.2 – 72.2 Mbps
- Advanced 1x1 802.11n features: Full/Half Guard Interval
- Operating Temperature: -40°C to 85°C

Typical Applications:

- PDA, Pocket PC, computing devices.
- Building automation and smart energy control.
- Industrial sensing and remote equipment monitoring.
- Warehousing, logistics and freight management.
- PC and gaming peripherals.
- Printers, scanners, alarm and video systems.
- Medical applications including patient monitoring and remote diagnostics.

2 Part Number Description

Device	Description	Ordering Number
ISM43362-L36-E	802.11 SiP Module based on Broadcom BCM43362 with on board etch antenna	ISM43362-L36-E
ISM43362-L36-U	802.11 SiP Module based on Broadcom BCM43362 with U.FL connector for external antenna	ISM43362-L36-U
ISM43362-L36-EVB	SDIO Evaluation Board	ISM43362-L36-EVB

3 General Features

- Based on the Broadcom BCM43362 MAC/Baseband/Radio device.
- Supports Broadcom WICED SDK.
- IEEE 802.11n D7.0 -OFDM-72.2 Mbps -single stream w/20 MHz, Short GI
- IEEE 802.11g (OFDM 54 Mbps)
- IEEE 802.11b (DSSS 11Mbps)
- IEEE 802.11i (Security)
 - WPA (Wi-Fi Protected Access) –PSK/TKIP
 - WPA2 (Wi-Fi Protected Access 2)- AES/CCMP/802.1x Authentication
- Inputs +3.3 V tolerant
- Lead Free Design which is compliant with ROHS requirements.
- EMI/EMC Metal Shield recommended for best RF performance in noisy environments and to accommodate for lower RF emissions/signature for easier FCC compliance.

4 Specifications

4.1 Module Architecture / Block Diagram

Figure 1 Inventek's ISM43362-L36 General Block Diagram

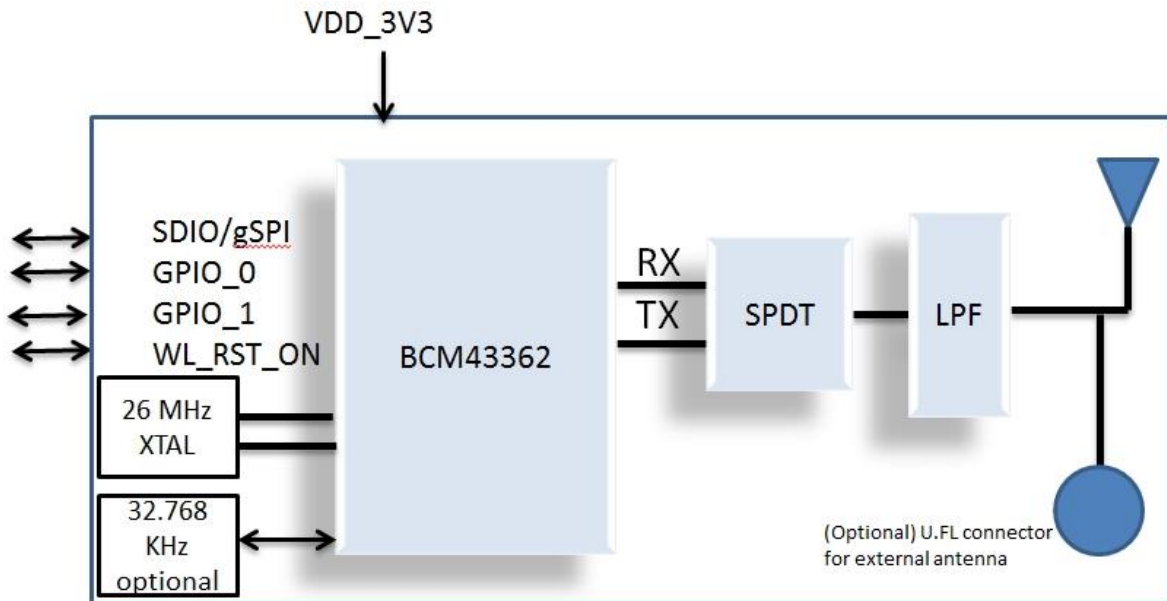

5 Limitations

Inventek Systems products are not authorized for use in safety-critical applications (such as life support) where a failure of the Inventek Systems product would reasonably be expected to cause severe personal injury or death.

5.1 Regulatory Compliance



Regulator	Status
FCC	07P-362
IC	10147A-362
CE	Certified
RoHS	Compliant

5.2 FCC and IC User's Manual Statements:

OEM INSTRUCTIONS:

This module is limited to OEM installation only.

OEM integrators must ensure that the end-user has no manual instructions to remove or install the module.. OEM's must comply with FCC marking regulation part 15 declaration of conformity (Section 2.925(e)).

This module is to be installed only in mobile or fixed applications (Please refer to FCC CFR 47 Part 2.1091(b) for a definition of mobile and fixed devices).

Separate approval is required for all other operating configurations, including portable configurations with respect to FCC CFR 47 Part 2.1093, and different antenna configurations.

The antennas used with this module must be installed to provide a separation distance of at least 20cm from all persons, and must not be co-located or transmit simultaneously with any other antenna or transmitter, except in accordance with FCC multi transmitter product procedures.

The ISM43362 Module has been designed to operate with the following antennas and gains. Use with other antenna types or with these antenna types at higher gains is strictly prohibited.

Manufacturer	Type of Antenna	Model	Gain dB	Type of Connector
Inventek	U.FL port Antenna	W24P-U	2.15	Unique Connector
Inventek	Trace Antenna	NA	0	Permanent integral

FCC Notice-

This device complies with Part 15 of the FCC rules. Operation is subject to the following two conditions: (1) this device may not cause harmful interference, and (2) this device must accept any interference received, including interference that may cause undesired operation.

Note: This equipment has been tested and found to comply with the limits for a Class B digital device, pursuant to part 15 of the FCC Rules. These limits are designed to provide reasonable protection against harmful interference in a residential installation. This equipment generates uses and can radiate radio frequency energy and, if not installed and used in accordance with the instructions, may cause harmful interference to radio communications.

However, there is no guarantee that interference will not occur in a particular installation. If this equipment does cause harmful interference to radio or television reception, which can be determined by turning the equipment off and on, the user is encouraged to try to correct the interference by one or more of the following measures:

- Reorient or relocate the receiving antenna.
- Increase the separation between the equipment and receiver.
- Connect the equipment into an outlet on a circuit different from that to which the receiver is connected.
- Consult the dealer or an experienced radio/TV technician for help.

Warning: changes or modifications not expressly approved by the party responsible for compliance could void the user's authority to operate this equipment.

A clearly visible label is required on the outside of the user's (OEM) enclosure stat the following text:

Contains FCC ID: O7P-362
 Contains IC: 10147A-362

This transmitter module has been certified for FCC Part 15 operation; when installed in a host device, the host manufacturer is responsible for making sure that the host device with the transmitter installed continues to be compliant with Part 15B unintentional radiator requirements.

5.3 **Industry Canada User's Manual Statements:**

IC RSS-210/RSS-Gen Notices-

Operation is subject to the following two conditions: (1) this device may not cause interference, and (2) this device must accept any interference, including interference that may cause undesired operation of this device.

L'opération est soumise aux deux conditions suivantes: (1) cet appareil ne peut pas provoquer d'interférences et (2) cet appareil doit accepter toute interférence, y compris les interférences qui peuvent causer un mauvais fonctionnement de l'appareil.

Under Industry Canada regulations, this radio transmitter may only operate using an antenna of a type and maximum (or lesser) gain approved for the transmitter by Industry Canada. To reduce potential radio interference to other users, the antenna type and its gain should be so chosen that the equivalent isotropically radiated power (e.i.r.p.) is not more than that necessary for successful communication.

Sous la réglementation d'Industrie Canada, ce transmetteur radio ne peut fonctionner en utilisant une antenne d'un type et un maximum (ou moins) gain approuvées pour l'émetteur par Industrie Canada. Pour réduire le risqué d'interférence aux autres utilisateurs, le type d'antenne et son gain doivent être choisis de manière que la puissance isotrpe rayonnée équivalente (PIRE) ne dépasse pas ce qui est nécessaire pour une communication réussie.

The radio transmitter has been approved by Industry Canada to operate with the antenna types listed above with the maximum permissible gain and required antenna impedance for each antenna type indicated. Antenna types not included in this list having a gain greater than the maximum gain indicated for that type, are strictly prohibited for use with this device.

Cet émetteur de radio a été approuvé par Industrie Canada pour fonctionner avec les types d'antennes énumérées ci-dessus avec le gain maximal admissible et impédance d'antenna requise pour chaque type d'antenne indiqué. Types d'antennes ne figurant pas dans cette liste, ayant un gain supérieur au gain maximum indiqué pour ce type, sont strictement interdites p

6 Complementary Documentation

6.1 *Inventek Systems*

- Evaluation Board
 - ISM43362-L36 SDIO Evaluation Board Specification
- Firmware (NDA/ SLA required)

6.2 *Environmental Specifications*

Item	Description
Operating temperature range	-40 deg. C to +85 deg. C
Storage temperature range	-40 deg. C to +85 deg. C
Humidity	95% max non-condensing

Note 1: The ISM43362-L36 supports a functional operating range of -40°C to +85°C. However the optimal RF performance specified in this data sheet is only guaranteed for temperatures from -10°C to +65°C

7 Electrical Specifications

7.1 *Recommended Operating Ratings*

Symbol	Min.	Typ.	Max.	Unit.
VDD_3V3	3.0	3.3	3.6	V
Voltage Ripple	+/- 2% max values not exceeding operating voltage			

8 Power Consumption

Condition: 250C, VDD_3V3.

Item	Condition	Min	Nom	Max	Unit
Tx mode(11b Max current)	11Mbps		345	410	mA
Tx mode(11g Max current)	54Mbps		250	310	mA
Tx mode(11n Max current)	MCS7		210	270	mA
Rx mode(Rx @Max gain)	11b (11Mbps)		115	150	mA
	11g (54Mbps)		115	150	mA
	11n (MCS7)		115	150	mA

9 Wi-Fi RF Specification

9.1 RF Specification

Conditions: VDD=3.3V; TEMP: 25°C

Feature	Descriptin
WLAN Standard	IEEE 802.11b/g/n, Wi-Fi compliant
Frequency Range	2.400 GHz ~ 2.497 GHz (2.4 GHz ISM Band)
Number of Channels	Ch1 ~ Ch14
Modulation	802.11 g/n : OFDM /64-QAM, 16-QAM, QPSK, BPSK 802.11b : CCK, DQPSK, DBPSK
Output Power	802.11b /11Mbps : 17 dBm ± 1.5 dB
	802.11g /54Mbps: 13 dBm ± 1.5 dB
	802.11n /72Mbps: 11 dBm ± 1.5 dB
Receive Sensitivity (11n,20MHz) @10% PER	- MCS=0 PER @ -86 dBm, typical
	- MCS=1 PER @ -85 dBm, typical
	- MCS=2 PER @ -85 dBm, typical
	- MCS=3 PER @ -84 dBm, typical
	- MCS=4 PER @ -80 dBm, typical
	- MCS=5 PER @ -78 dBm, typical
	- MCS=6 PER @ -72 dBm, typical
- MCS=7 PER @ -69 dBm, typical	
	- 6Mbps PER @ -89 dBm, typical
	- 9Mbps PER @ -88 dBm, typical
	- 12Mbps PER @ -88 dBm, typical
	- 18Mbps PER @ -87 dBm, typical

Receive Sensitivity (11g) @10% PER	- 24Mbps PER @ -83 dBm, typical
	- 36Mbps PER @ -80 dBm, typical
	- 48Mbps PER @ -75 dBm, typical
	- 54Mbps PER @ -72 dBm, typical
Receive Sensitivity (11b) @10% PER	- 1Mbps PER @ -93 dBm, typical
	- 2Mbps PER @ -91 dBm, typical
	- 5.5Mbps PER @ -89 dBm, typical
	- 11Mbps PER @ -87 dBm, typical
Data Rates	802.11b : 1, 2, 5.5, 11Mbps
	802.11g : 6, 9, 12, 18, 24, 36, 48, 54Mbps
Data Rate (20MHz ,Long GI,800ns)	802.11n: 6.5, 13, 19.5, 26, 39, 52, 58.5, 65Mbps
Data Rate (20MHz ,short GI,400ns)	802.11n : 7.2, 14.4, 21.7, 28.9, 43.3, 57.8, 65,72.2Mbps
Maximum Receive Input Level	802.11b : -10 dBm
	802.11g : -10 dBm

9.2 802.11b Transmit

802.11b Transmit					
Item	Condition	Min.	Typ.	Max.	Unit
Transmit output power level	1M/2M/5.5M/11M	15	17	19	dBm
Transmit center frequency tolerance		-25	0	25	ppm
Transmit spectrum mask	$F_c - 22\text{MHz} < F < F_c - 11\text{MHz}$ & $F_c + 11\text{MHz} < F < F_c + 22\text{MHz}$ (1/2/5.5/11Mbps; channel 1~13)			-30*	dBr
	$F < F_c - 22\text{MHz}$ & $F > F_c + 22\text{MHz}$ (1/2/5.5/11Mbps; channel 1~13)			-50*	dBr
Transmit power -on	10% ~ 90 %		0.3	2*	us
Transmit power -down	90% ~ 10 %		1.5	2*	us
Transmit modulation accuracy	1/2/5.5/11 Mbps		-17	-10	dB

** indicates IEEE802.11 specification

9.3 802.11g Transmit

802.11g Transmit					
Item	Condition	Min.	Typ.	Max.	Unit
Transmit output power level	6M/9M/12M/18M/24M/36M/48M/54M	11	13	15	dBm
					dBm
					dBm
Transmit center frequency tolerance		-20	0	20	ppm
Transmit modulation accuracy	6Mbps			-5*	dB
	9Mbps			-8*	dB
	12Mbps			-10*	dB
	18Mbps			-13*	dB
	24Mbps			-16*	dB
	36Mbps			-19*	dB
	48Mbps			-22*	dB
54Mbps		-30	-25*	dB	
Transmit spectrum mask	@ 11MHz			-20*	dBr
	@ 20MHz			-28*	dBr
	@ 30MHz			-40*	dBr

9.4 802.11n Transmit

802.11n Transmit					
Item	Condition	Min.	Typ.	Max.	Unit
Transmit output power level	HT20 MCS 0~7	9	11	13	dBm
					dBm
					dBm
Transmit center frequency tolerance	HT20 MCS 0~7	-20	0	20	ppm
Transmit modulation accuracy	HT20, MCS0~7		-30	-27*	dB
					dB
Transmit Spectrum mask	@ 11MHz			-20*	dBr
	@ 20MHz			-28*	dBr
	@ 30MHz			-45*	dBr

9.5 802.11b Receiver

802.11 b Receiver					
Item	Condition	Min.	Typ.	Max.	Unit
Receiver minimum input level sensitivity (PER< 8 %)	1Mbps		-90	-80*	dBm
	2Mbps		-90	-80*	dBm
	5.5Mbps		-88	-76*	dBm
	11Mbps		-85	-76*	dBm
Receiver maximum input level sensitivity (PER< 8 %)	1/2/5.5/11 Mbps			-10*	dBm

“*” indicates IEEE802.11_2012 specification

9.6 802.11g Receiver

802.11g Receiver					
Item	Condition	Min.	Typ.	Max.	Unit
Receiver minimum input level sensitivity (PER<10 %)	6Mbps		-85	-82*	dBm
	9Mbps		-85	-81*	dBm
	12Mbps		-85	-79*	dBm
	18Mbps		-84.5	-77*	dBm
	24Mbps		-82	-74*	dBm
	36Mbps		-78.5	-70*	dBm
	48Mbps		-74	-66*	dBm
	54Mbps		-70	-65*	dBm
Receiver maximum input level (PER<10%)	6/9/12/18/24/36/48/54			-20*	dBm

“*” indicates IEEE802.11_2012 specification

9.7 802.11n Receiver

802.11n Receiver					
Item	Condition	Min.	Typ.	Max.	Unit
Receiver minimum input level sensitivity (PER<10 %)	HT20, MCS0		-85	-82*	dBm
	HT20, MCS1		-83	-79*	dBm
	HT20, MCS2		-81	-77*	dBm
	HT20, MCS3		-79	-74*	dBm
	HT20, MCS4		-76	-70*	dBm
	HT20, MCS5		-73	-66*	dBm
	HT20, MCS6		-70	-65*	dBm
	HT20, MCS7		-68	-64*	dBm
Receiver maximum input level (PER<10%)	MSC0~MSC7			-20*	dBm

“*” indicates IEEE802.11_2012 specification

8.1.1 Detailed Pin Description

Pin	Pin name	I/O	Description
1	GND		Ground
2	GND		Ground
3	GND		Ground
4	SDIO_D0/SPI_MISO	I/O	SDIO data line 0 with internal weak pull-up that can be disabled.
5	SDIO_D1/SPI_IRQ	I/O	SDIO data line 1 with internal weak pull-up that can be disabled.
6	SDIO_D2	I/O	SDIO data line 2 with internal weak pull-up that can be disabled.
7	SDIO_D3/SPI_CSX	I/O	SDIO data line 3 with internal weak pull-up that can be disabled.
8	SDIO_CMD/SPI_MOSI	I/O	SDIO command line with internal weak pull-up that can be disabled.
9	SDIO_CLK/SPI_CLK	I	SDIO/SPI clock.
10	GND		Ground
11	VDD_3V3	I	Module power supply
12	VDD_3V3_3	I	Power for IO and SDIO pads.
13	WL_RST_N		
14	SLEEP_CLK	I	Optional external 32KHz sleep clock. Tie to GND if not used.
15	GND		Ground
16	BTCX_RF_ACTIVE/GPIO5	I/O	GPIO/Coexistence signal indicating Bluetooth is active. Hi-Z at power-up and reset.
17	BTCX_STATUS/GPIO4	I/O	GPIO/Coexistence signal indicating Bluetooth priority status and TX/RX direction, Hi-Z at power-up and reset.
18	BTCX_TXCONF/GPIO3	I/O	GPIO/Coexistence output giving Bluetooth permission to transmit, Hi-Z at power-up and reset.
19	BTCX_FREQ/GPIO1	I/O	GPIO/Coexistence output signal indicating Bluetooth transmission in restricted channel. Hi-Z power-up and reset
20	GPIO0	I/O	GPIO/Strapping option for SDIO (pull low) or SPI mode (pull high). Has weak internal pull-down.
21	GND		Ground
22	RF_SW_CTRL3	O	
23	RF_SW_CTRL0	O	
24	GND		Ground
24	GND		Ground
25	GND		Ground
26	GND		Ground
27	GND		Ground
28	GND		Ground
29	GND		Ground
30	GND		Ground
31	GND		Ground

32	GND		Ground
33	GND		Ground
34	GND		Ground
35	GND		Ground
36	GND		Ground

10 Footprint

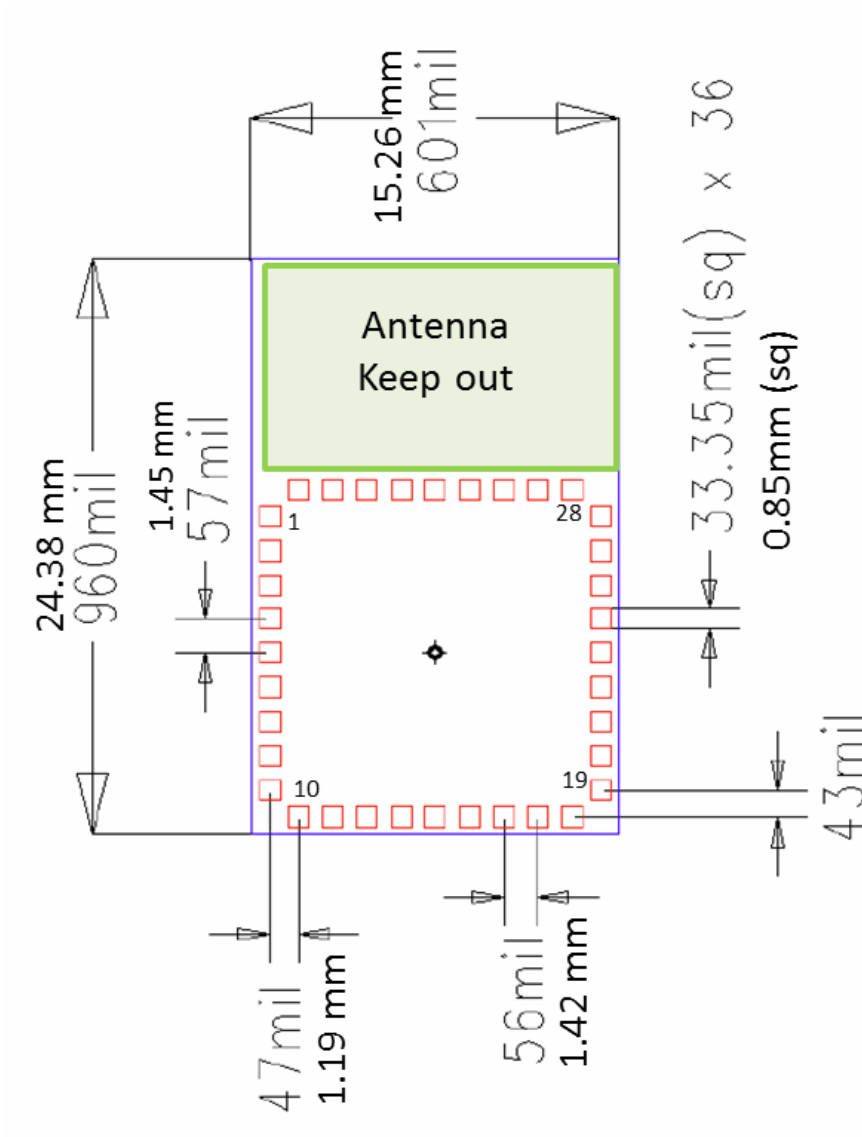

"Keep out" area should ideally have the antenna hanging off the side of the PCB for best performance. If you do not hang the antenna off the PCB, ensure no ground planes or traces are placed under the antenna (keep out area). Surrounding metal will affect the antenna performance. The ISM43362-M3G-L44-U and -E have the same footprint.

11 PCB Layout (Top View)

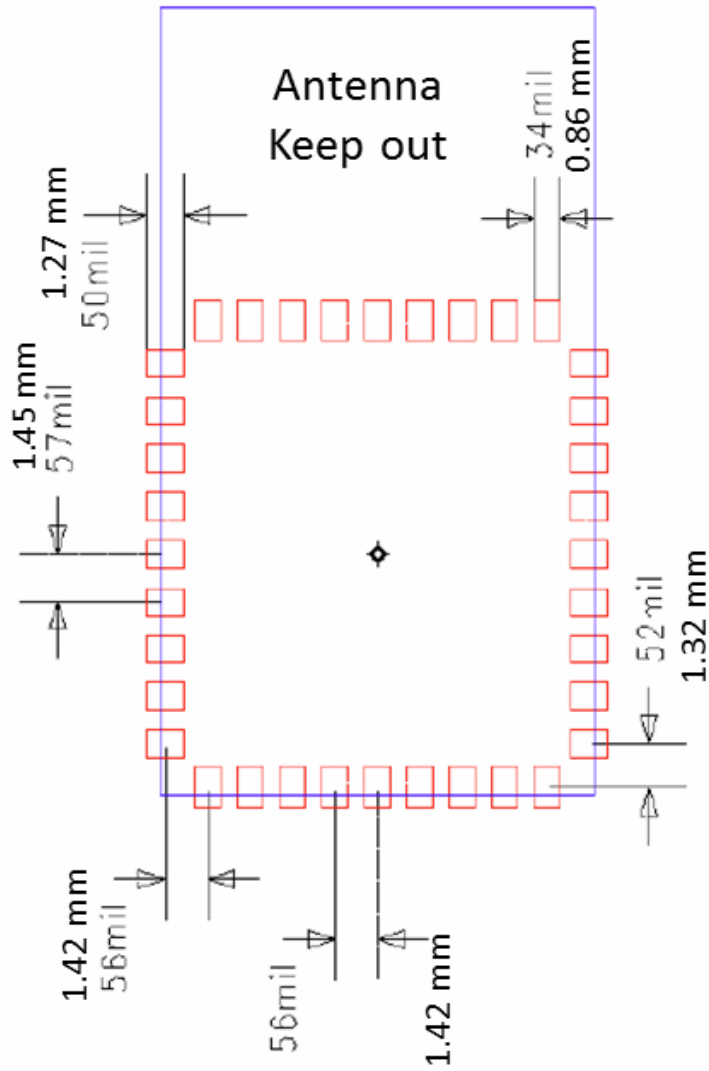

12 Boot Sequence

Shown below is the WLAN boot-up sequence from power-up to firmware download, including the initial device power-on reset(POR) evoked by the WL_RST_N(pin G4) signal. After initial power-up, the WL_RST_N signal can be held low to disable the ISM43362 or pulsed low induce a subsequent reset

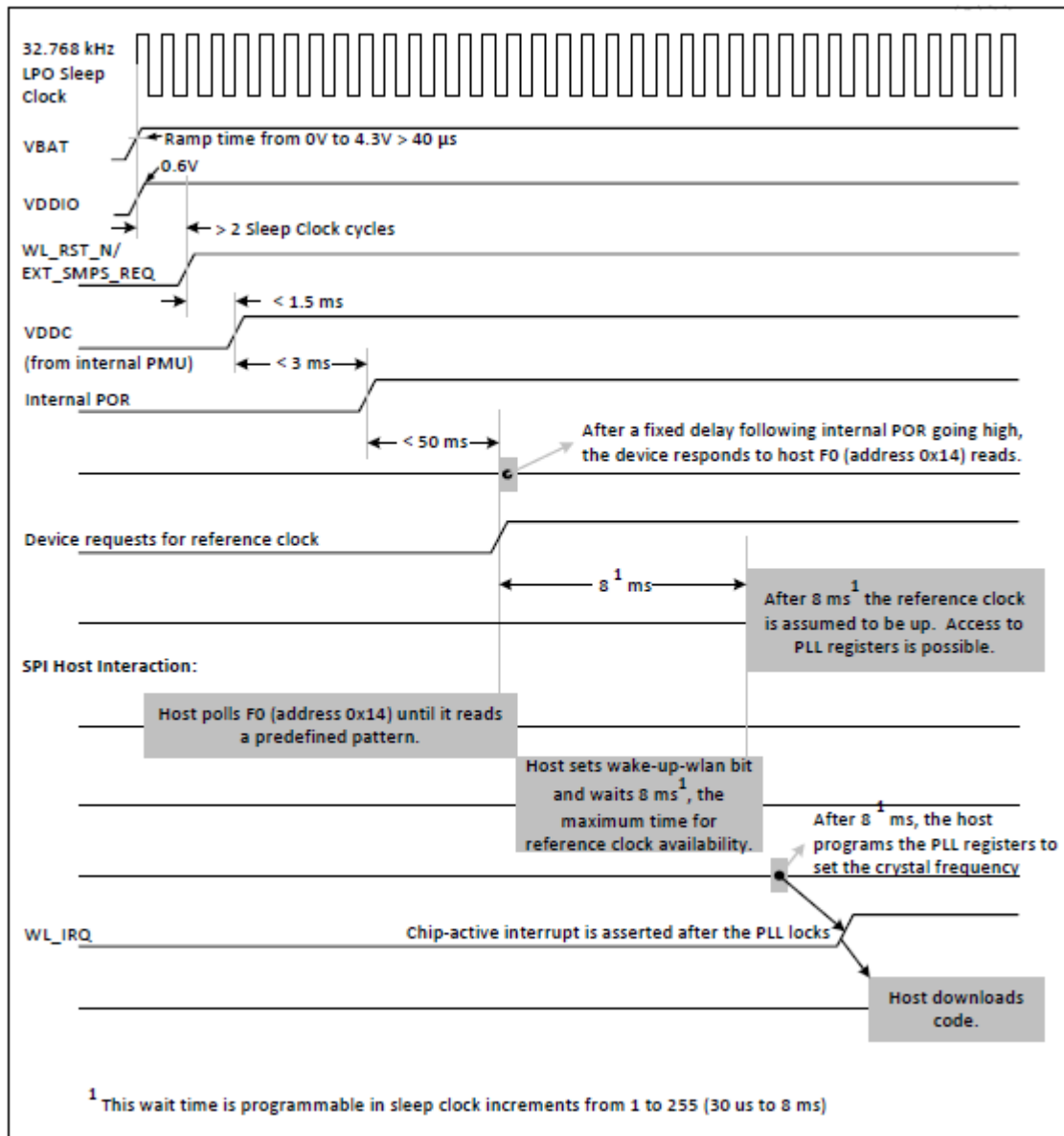

Figure 2 Boot Sequence

13 Communications Interfaces

13.1 SDIO and gSPI CONFIGURATION

SDIO and gSPI pin definition. Thw SDIO PCB signal traces should be of equal length. Typically we recommend SDIO for most applications.

	SDIO	gSPI
GPIO_0	0	1

Figure 3 SDIO and gSPI option

Pin Definition	SDIO	gSPI
4	SDIO_Data0	SPI_MISO
5	SDIO_DATA1	SPI_IRQ
6	SDIO_DATA2	
7	SDIO_DATA3	SPI_CSX
8	SDIO_CMD	SPI_MOSI
9	SDIO_CLK	SPI_CLK

13.2 SDIO Timing (Default Mode)

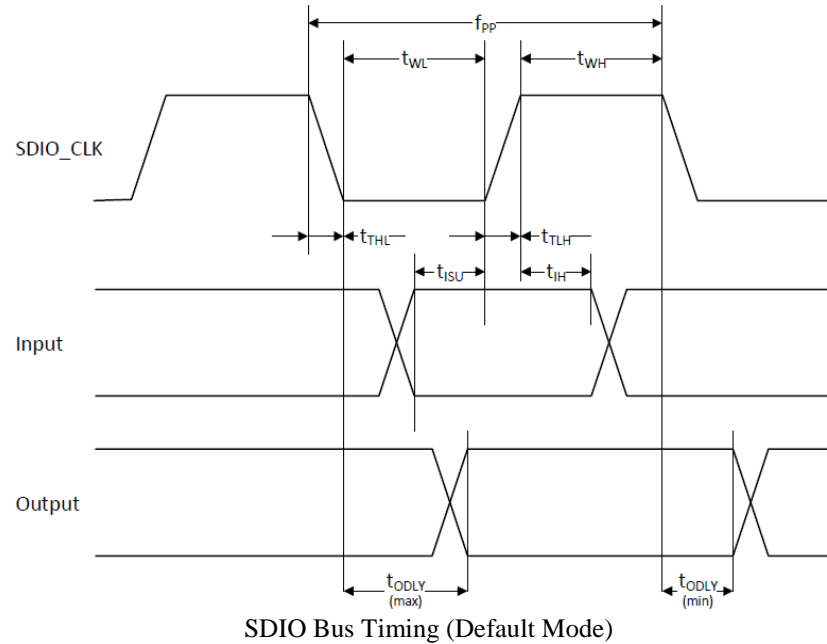

<i>Parameter</i>	<i>Symbol</i>	<i>Min.</i>	<i>Typ.</i>	<i>Max.</i>	<i>Unit</i>
Frequency – Data Transfer mode	fPP	0	-	25	MHz
Frequency – Identification mode	fOD	0	-	400	KHz
Clock low time	tWL	10	-	-	ns
Clock high time	tWH	10	-	-	ns
Clock rise time	tTLH	-	-	10	ns
Clock low time	tTHL	-	-	10	ns
Input setup time	tISU	5	-	-	ns
Input hold time	tIH	5	-	-	ns
Output delay time – Data Transfer mode	tODLY	0	-	14	ns
Output delay time – Identification mode	tODLY	0	-	50	ns

13.3 SDIO Timing (High Speed Mode)

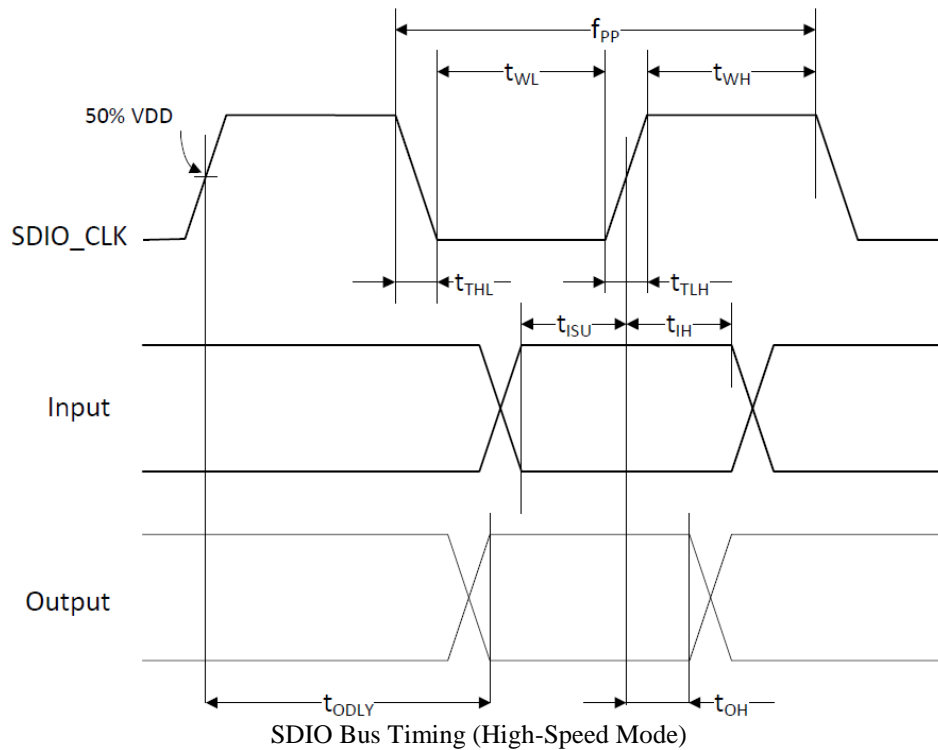

<i>Parameter</i>	<i>Symbol</i>	<i>Min.</i>	<i>Typ.</i>	<i>Max.</i>	<i>Unit</i>
Frequency – Data Transfer mode	f_{PP}	0	-	50	MHz
Frequency – Identification mode	f_{OD}	0	-	400	KHz
Clock low time	t_{WL}	7	-	-	ns
Clock high time	t_{WH}	7	-	-	ns
Clock rise time	t_{TLH}	-	-	3	ns
Clock low time	t_{THL}	-	-	3	ns
Input setup time	t_{ISU}	6	-	-	ns
Input hold time	t_{IH}	2	-	-	ns
Output delay time – Data Transfer mode	t_{ODLY}	0	-	14	ns
Output hold time	t_{OH}	2.5	-	-	ns
Total system capacitance (each line)	CL	-	-	40	ns

13.4 gSPI Interface Characteristics

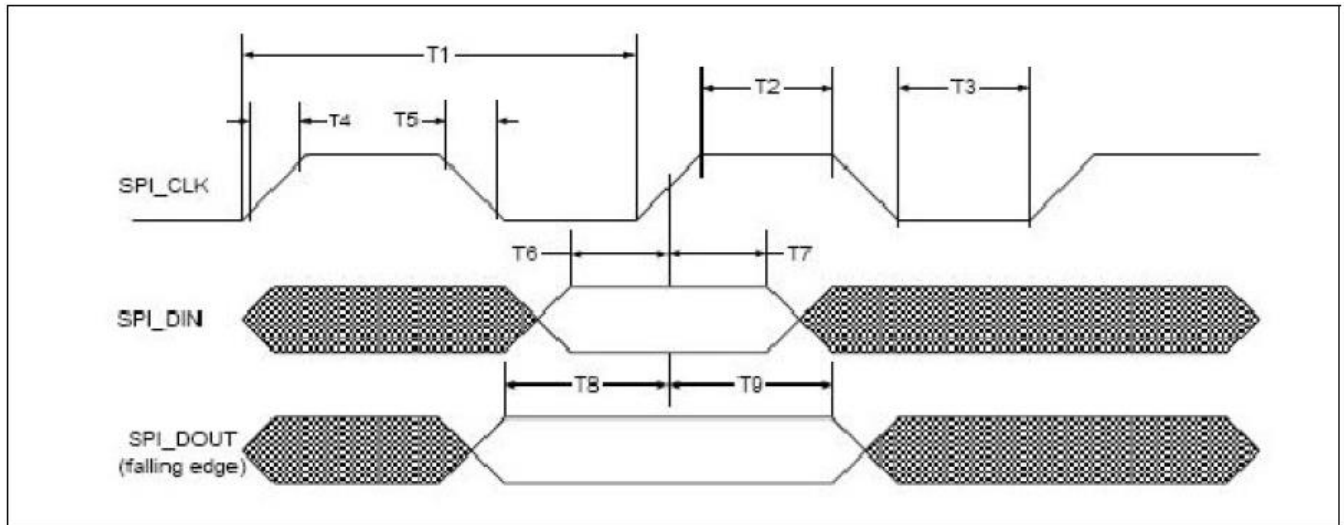

gSPI Timing

Parameter	Symbol	Min.	Max.	Unit	note
Clock period	T1	20.8	-	ns	Fmax = 48 MHz
Clock high/low	T2/T3	$(0.45 \times T1) - T4$	$(0.55 \times T1) - T4$	ns	-
Clock rise/fall time	T4/T5	-	2.5	ns	-
Input setup time	T6	5.0	-	ns	Setup time, SIMO valid to SPI_CLK active edge
Input hold time	T7	5.0	-	ns	Hold time, SPI_CLK active edge to SIMO invalid
Output setup time	T8	5.0	-	ns	Setup time, SOMI valid before SPI_CLK rising
Output hold time	T9	5.0	-	ns	Hold time, SPI_CLK active edge to SOMI invalid
CSX to clock ^a	-	7.86	-	ns	CSX fall to 1st rising edge
Clock to CSX ^c	-	-	-	ns	Last falling edge to CSX high

gSPI Timing Parameters

a. SPI_CSx remains active for entire duration of gSPI read/write/write_read transaction(i.e., overall words for multiple word transaction).

Mode	SDIO	gSPI
Data0	SDIO D0	DO:Data Output
Data1	SDIO D1	IRQ:Interrupt
Data2	SDIO D2	NC:Not Used
Data3	SDIO D3	CS:Card Select
CLK	SDIO CLK	SCLK:Clock
CMD	SDIO CMD	DI:Data Input

Table: SDIO mode and gSPI mode

13.5 PCB Etch Antenna Gain on the Evaluation Board

The eS-WiFi PCB etched antenna performance is shown below. This etched antenna is FCC/IC and CE certified and the radiation patterns shown below are based on simulation using evaluation boards that have a ground plane with dimensions of 71mm x 48mm.

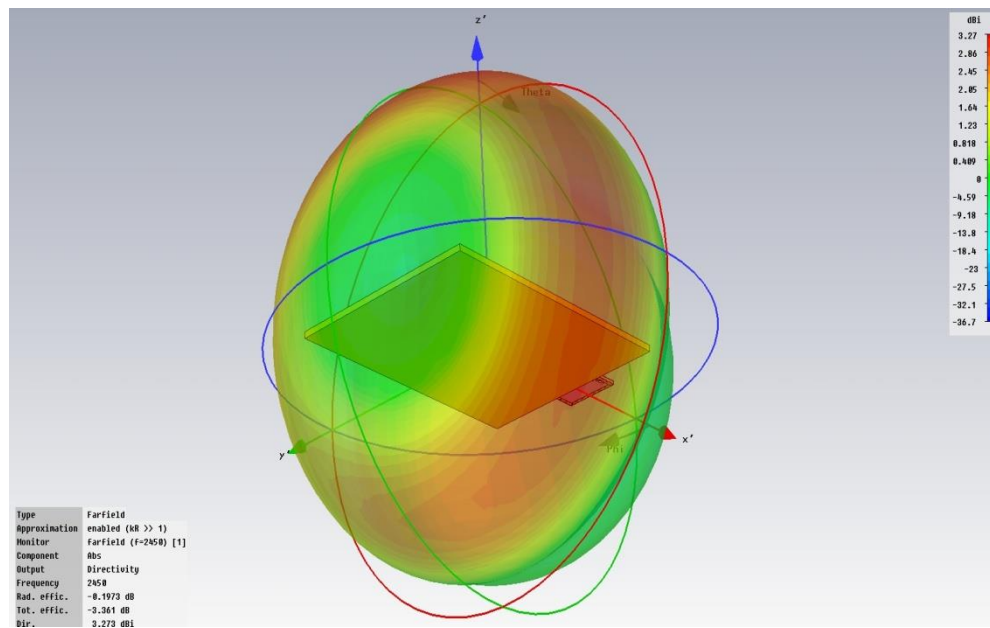
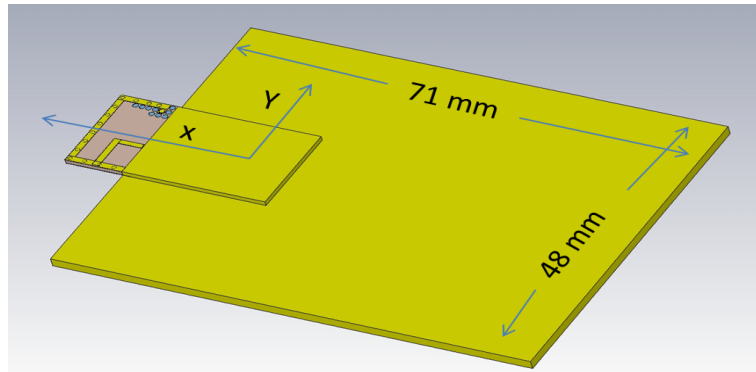

13. 6 Farfield Directivity

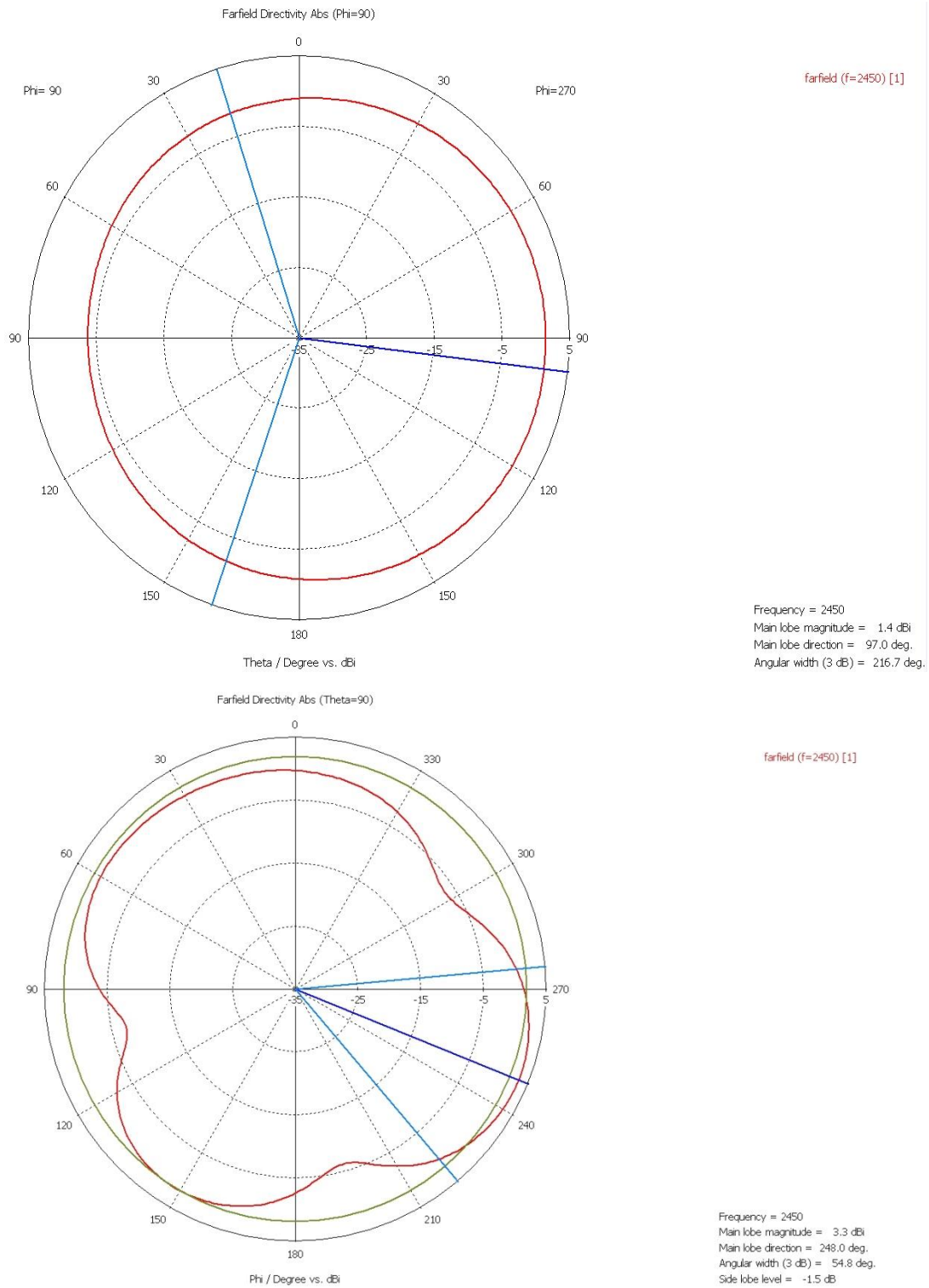

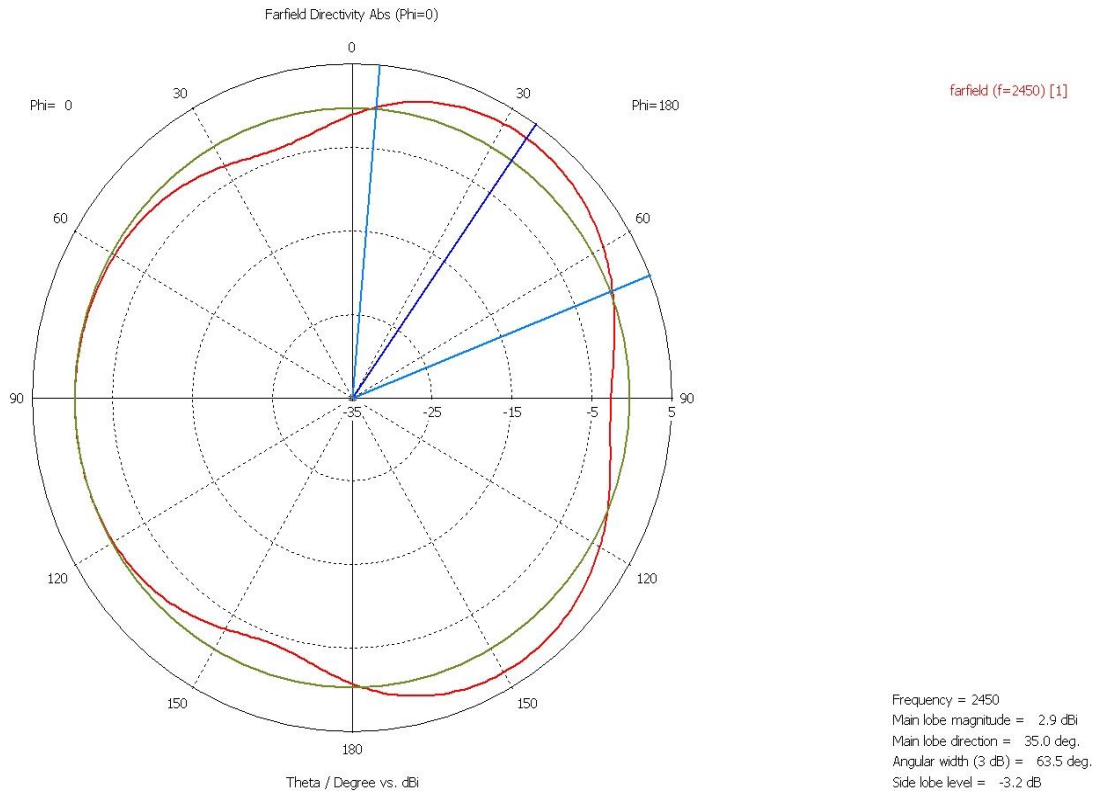

14.1 External Antenna Option

The Inventek W24P-U PCB antenna was used for FCC testing and can be found on the Inventek Website.

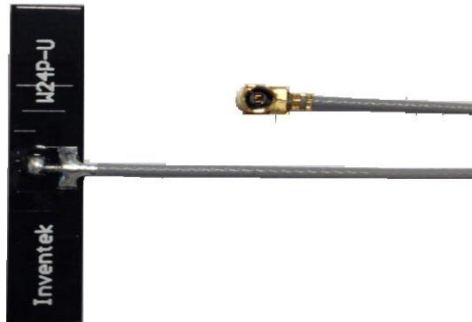

15 Product Compliance Considerations

RoHS: Restriction of Hazardous Substances (RoHS) directive has come into force since 1st July 2006 all electronic products sold in the EU must be free of hazardous materials, such as lead. Inventek is fully committed to being one of the first to introduce lead-free products while maintaining backwards compatibility and focusing on a continuously high level of product and manufacturing quality.

EMI/EMC: The Inventek module design embeds EMI/EMC suppression features and accommodations to allow for higher operational reliability in noisier (RF) environments and easier integration compliance in host (OEM) applications.

16 Reflow Profile

- Reference the IPC/JEDEC standard.
- Peak Temperature: <math><250^{\circ}\text{C}</math>
- Number of Times: ≤ 2 times

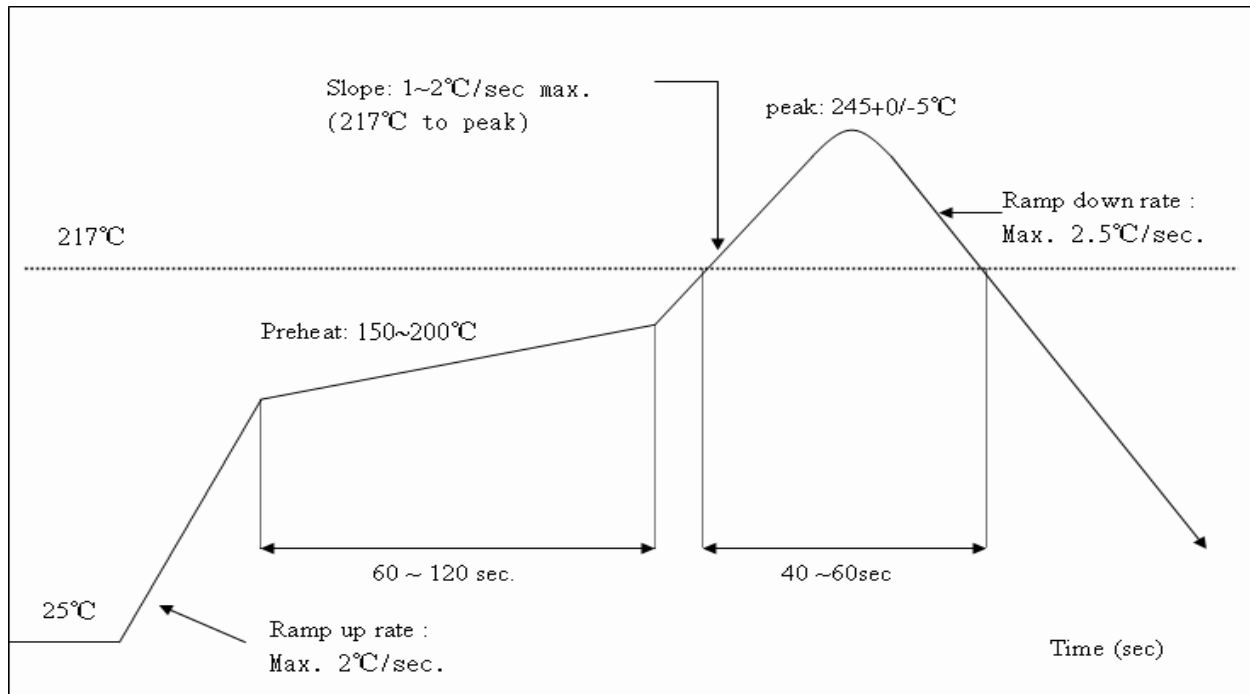

17 Packaging Information

17.1 MSL Level / Storage Condition

	<h3>Caution</h3> <p>This bag contains</p> <h3>MOISTURE-SENSITIVE DEVICES</h3> <p>Do not open except under controlled conditions</p>	<p>LEVEL</p> <div style="border: 1px solid black; padding: 5px; width: 40px; margin: 0 auto;"> <h1 style="margin: 0;">4</h1> </div>
	<p>1. Calculated shelf life in sealed bag: 12 months at <math>< 40^{\circ}\text{C}</math> and <math>< 90\%</math> relative humidity(RH)</p> <p>2. Peak package body temperature: 225°C 240°C 250°C 260°C</p> <p style="margin-left: 100px;"> <input type="checkbox"/> <input type="checkbox"/> <input checked="" type="checkbox"/> <input type="checkbox"/> </p> <p>3. After bag is opened, devices that will be subjected to reflow solder or other high temperature process must</p> <p style="margin-left: 20px;">a) Mounted within: 48 hours of factory conditions <math>< 30^{\circ}\text{C}/60\%</math> RH, OR</p> <p style="margin-left: 20px;">b) Stored at <math>< 10\%</math> RH</p> <p>4. Devices require bake, before mounting, if:</p> <p style="margin-left: 20px;">a) Humidity Indicator Card is >10% when read at $23 \pm 5^{\circ}\text{C}$</p> <p style="margin-left: 20px;">b) 3a or 3b not met</p> <p>5. If baking is required, devices may be baked for 24 hours at $125 \pm 5^{\circ}\text{C}$</p> <p>Note : If device containers cannot be subjected to high temperature or shorter bake times are desired, reference IPC/JEDEC J-STD-033 for bake procedure</p> <p>Bag Seal Date: <u> See-SEAL DATE LABEL </u></p> <p>Note: Level and body temperature defined by IPC/JEDEC J-STD-020</p>	

17.2 *Device baking requirements prior to assembly*

Boards must be baked prior to rework or assembly to avoid damaging moisture sensitive components during localized reflow. The default bake cycle is 24 hours at 125C.

Maintaining proper control of moisture uptake in components is critical.

Before opening the shipping bag and attempting solder reflow, you should maintain a minimal out-of-bag time and ensure the highest possible package reliability for the final product.

Module's Assembly Instructions

Board Placement: The ISM43362-L36 has an optional on board Wi-Fi antenna. The board is designed to be a stuffing option. If you elect to use the on-board antenna, then board placement is critical in your system. Several key items to consider when placing the module are:

- Ensure that the antenna portion of the design is placed so that the antenna has no ground plane under, above or near the antenna. Ideally, the antenna requires clear sky for optimal performance. If you have shields or other material around the antenna, please test for interference and loss of signal strength.

REVISION CONTROL

Document : ISM43362-L36	Wi-Fi module
Internal Release	DOC-DS-20079-1.0

Date	Author	Revision	Comment
7/2/2014	MFT	1.0	Preliminary
8/14/2014	KMT	1.1	Updated Pin Description and Block Diagram

18 Contact Information

Inventek Systems
 2 Republic Road
 Billerica Ma, 01862
 Tel: 978-667-1962
Sales@inventeksys.com

www.inventeksys.com

Inventek Systems reserves the right to make changes without further notice to any products or data herein to improve reliability, function, or design. The information contained within is believed to be accurate and reliable. However Inventek Systems does not assume any liability arising out of the application or use of this information, nor the application or use of any product or circuit described herein, neither does it convey any license under its patent rights nor the rights of others.



Компания «ЭлектроПласт» предлагает заключение долгосрочных отношений при поставках импортных электронных компонентов на взаимовыгодных условиях!

Наши преимущества:

- Оперативные поставки широкого спектра электронных компонентов отечественного и импортного производства напрямую от производителей и с крупнейших мировых складов;
- Поставка более 17-ти миллионов наименований электронных компонентов;
- Поставка сложных, дефицитных, либо снятых с производства позиций;
- Оперативные сроки поставки под заказ (от 5 рабочих дней);
- Экспресс доставка в любую точку России;
- Техническая поддержка проекта, помощь в подборе аналогов, поставка прототипов;
- Система менеджмента качества сертифицирована по Международному стандарту ISO 9001;
- Лицензия ФСБ на осуществление работ с использованием сведений, составляющих государственную тайну;
- Поставка специализированных компонентов (Xilinx, Altera, Analog Devices, Intersil, Interpoint, Microsemi, Aeroflex, Peregrine, Syfer, Eurofarad, Texas Instrument, Miteq, Cobham, E2V, MA-COM, Hittite, Mini-Circuits, General Dynamics и др.);

Помимо этого, одним из направлений компании «ЭлектроПласт» является направление «Источники питания». Мы предлагаем Вам помощь Конструкторского отдела:

- Подбор оптимального решения, техническое обоснование при выборе компонента;
- Подбор аналогов;
- Консультации по применению компонента;
- Поставка образцов и прототипов;
- Техническая поддержка проекта;
- Защита от снятия компонента с производства.



Как с нами связаться

Телефон: 8 (812) 309 58 32 (многоканальный)

Факс: 8 (812) 320-02-42

Электронная почта: org@eplast1.ru

Адрес: 198099, г. Санкт-Петербург, ул. Калинина, дом 2, корпус 4, литера А.