

Silicon NPN Phototransistor Arrays

Version 1.3

BPX 80, BPX 82 ... BPX 89



Features:

- **Spectral range of sensitivity:** (typ) 450 ... 1100 nm
- **Package:** Miniature Array, Epoxy
- **Special:** Multiple-digit array package
- High linearity
- Available in groups

Applications

- Miniature photointerrupters
- Industrial electronics
- For control and drive circuits

Ordering Information

Type:	Photocurrent I_{PCE} [μA] $\lambda = 950 \text{ nm}$, $E_e = 0.5 \text{ mW/cm}^2$, $V_{CE} = 5 \text{ V}$	Ordering Code
BPX 82	> 320	Q62702P0021
BPX 83	> 320	Q62702P0025
BPX 84	> 320	Q62702P0030
BPX 85	> 320	Q62702P0031
BPX 86	> 320	Q62702P0022
BPX 87	> 320	Q62702P0032
BPX 88	> 320	Q62702P0033
BPX 89	> 320	Q62702P0026
BPX 80	> 320	Q62702P0028

Note: Only one bin within one packing unit (variation less than 2:1)

Maximum Ratings ($T_A = 25\text{ °C}$)

Parameter	Symbol	Values	Unit
Operating and storage temperature range	$T_{op}; T_{stg}$	-40 ... 80	°C
Collector-emitter voltage	V_{CE}	35	V
Collector current	I_C	50	mA
Collector surge current ($\tau < 10\ \mu\text{s}$)	I_{CS}	200	mA
Emitter-collector voltage	V_{EC}	7	V
Total Power dissipation	P_{tot}	90	mW
Thermal resistance	R_{thJA}	750	K / W
Electrostatic discharge (acc. to ANSI/ ESDA/ JEDEC JS-001 - HBM)	V_{ESD}	2000	V

Characteristics ($T_A = 25\text{ °C}$)

Parameter		Symbol	Values	Unit
Wavelength of max. sensitivity	(typ)	$\lambda_{S\ max}$	850	nm
Spectral range of sensitivity	(typ)	$\lambda_{10\%}$	(typ) 450 ... 1100	nm
Radiant sensitive area	(typ)	A	0.11	mm ²
Dimensions of chip area	(typ)	L x W	(typ) 0.55 x 0.55	mm x mm
Half angle	(typ)	φ	± 18	°
Capacitance ($V_{CE} = 0\text{ V}$, $f = 1\text{ MHz}$, $E = 0$)	(typ)	C_{CE}	7.5	pF
Dark current ($V_{CE} = 20\text{ V}$, $E = 0$)	(typ (max))	I_{CE0}	1 (≤ 50)	nA
Rise and fall time ($I_C = 1\text{ mA}$, $V_{CC} = 5\text{ V}$, $R_L = 1\text{ k}\Omega$)	(typ)	t_r, t_f	6	μs

Grouping ($T_A = 25\text{ °C}$, $\lambda = 950\text{ nm}$)

Group	Min Photocurrent $E_e = 0.5\text{ mW/cm}^2$, $V_{CE} = 5\text{ V}$ $I_{PCE, min}\text{ }[\mu\text{A}]$	Max Photocurrent $E_e = 0.5\text{ mW/cm}^2$, $V_{CE} = 5\text{ V}$ $I_{PCE, max}\text{ }[\mu\text{A}]$	Typ Photocurrent $E_V = 1000\text{ lx, Std. Light A, } V_{CE} = 5\text{ V}$ $I_{PCE}\text{ }[\mu\text{A}]$	Rise and fall time $I_C = 1\text{ mA, } V_{CC} = 5\text{ V, } R_L = 1\text{ k}\Omega$ $t_r, t_f\text{ }[\mu\text{s}]$
-A	320	630	1500	5.5
-B	400	800	1900	6
-C	500		2300	8

Group	Collector-emitter saturation voltage $I_C = I_{PCEmin} \times 0.3, E_e = 0.5\text{ mW/cm}^2$ $V_{CEsat}\text{ }[\text{mV}]$
-A	150
-B	150
-C	150

Note.: I_{PCEmin} is the min. photocurrent of the specified group.

For delivery the components are marked -A, -B, -C. Due to differing yields, it is not possible to order a definite group.

Relative Spectral Sensitivity ^{1) page 10}

$$S_{rel} = f(\lambda)$$

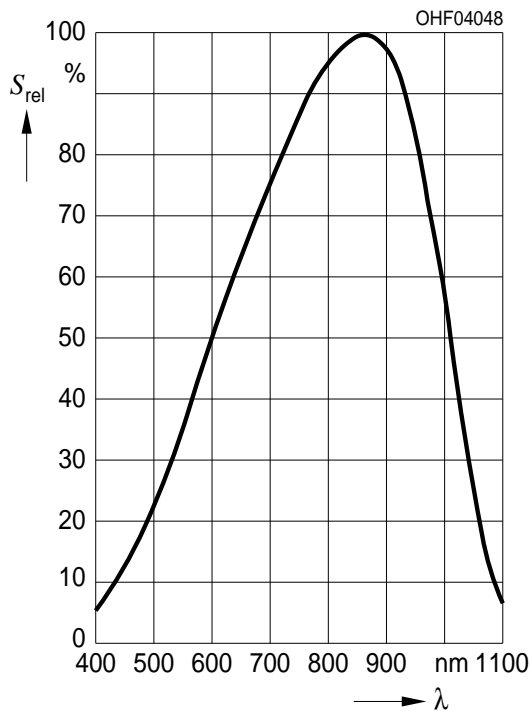

Photocurrent ^{1) page 10}

$$I_{PCE} = f(E_e), V_{CE} = 5\text{ V}$$

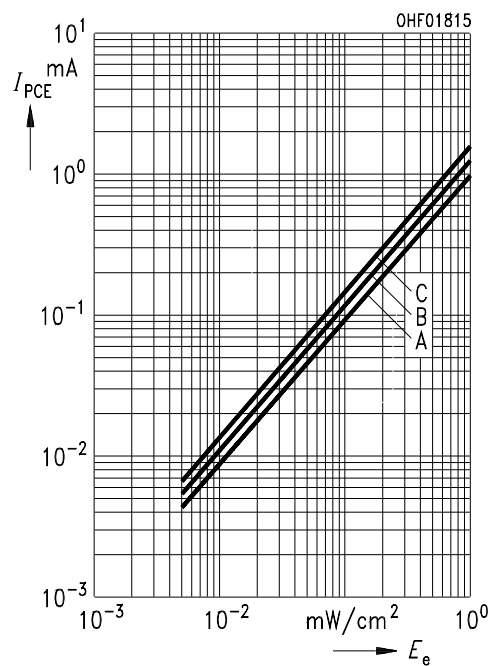

Photocurrent ^{1) page 10}

$I_{PCE} / I_{PCE(25^\circ C)} = f(T_A), V_{CE} = 5 V$

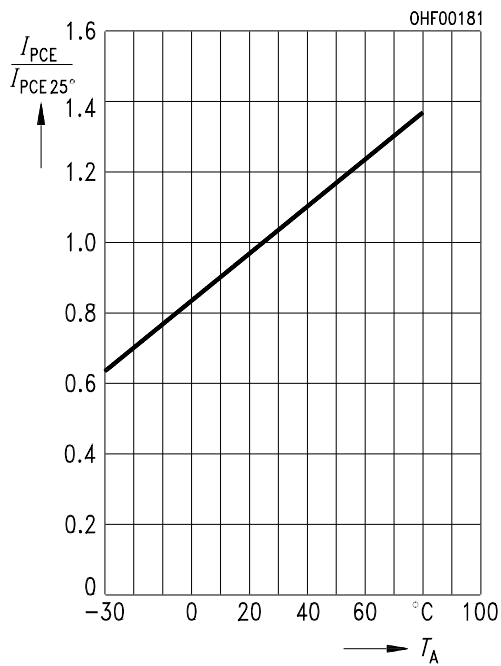

Dark Current ^{1) page 10}

$I_{CEO} = f(V_{CE}), E = 0$

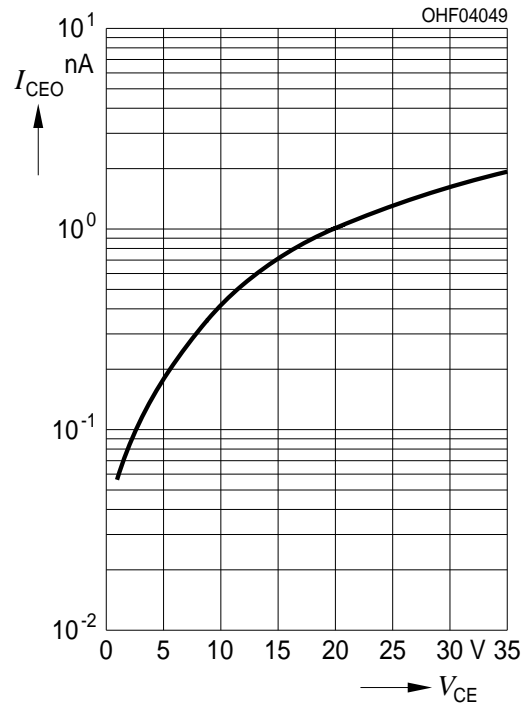

Dark Current ^{1) page 10}

$I_{CEO} = f(T_A), E = 0$

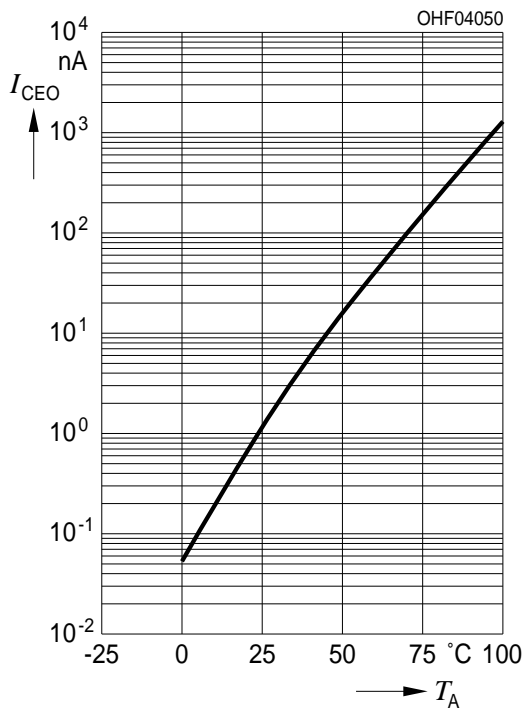

Collector-Emitter Capacitance ^{1) page 10}

$C_{CE} = f(V_{CE}), f = 1 MHz, E = 0$

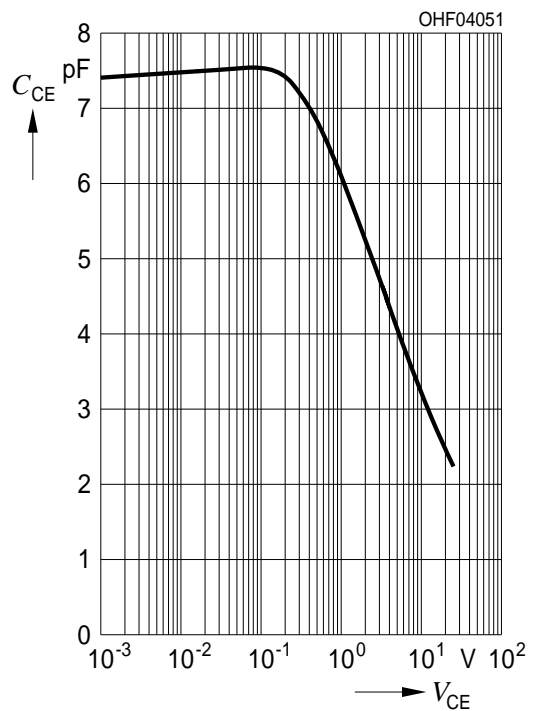

Power Consumption

$P_{tot} = f(T_A)$

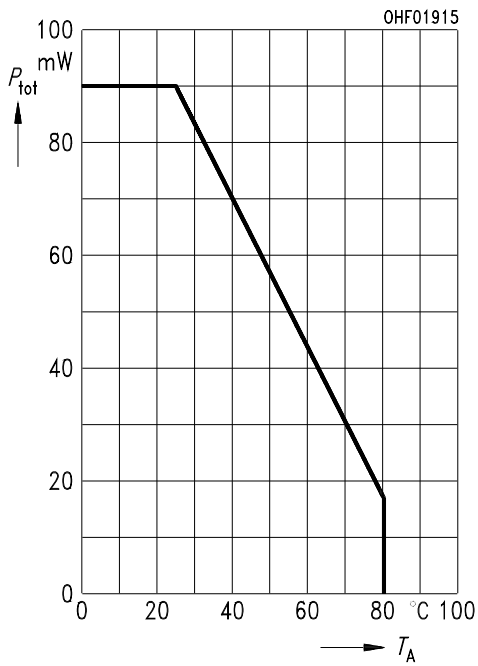

Directional Characteristics ^{1) page 10}

$S_{rel} = f(\phi)$

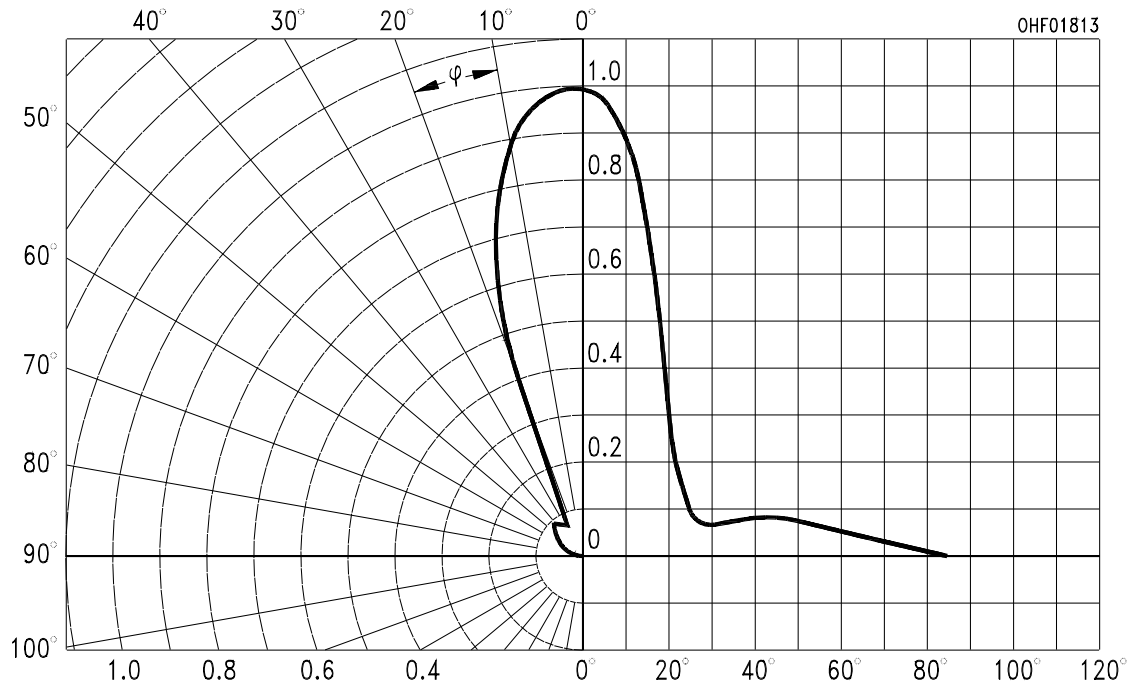

Package Outline

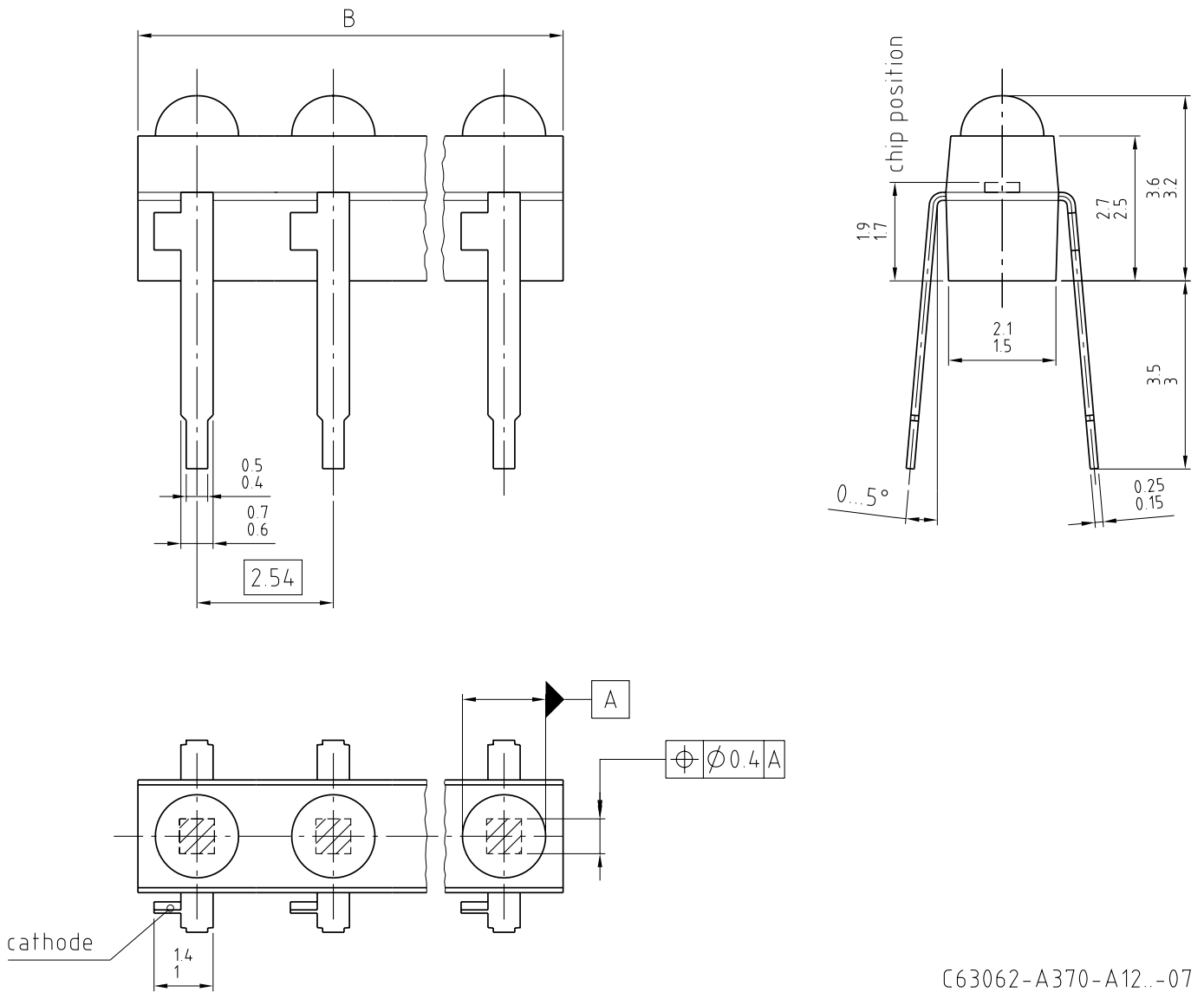

C63062-A370-A12..-07

Dimensions in mm.

Transistors

Number of Transistors per Array	Dimensions "B"
2	4.5 ... 4.9
3	7.0 ... 7.4
4	9.6 ... 10.0
5	12.1 ... 12.5
6	14.6 ... 16.0
7	17.2 ... 17.6
8	19.7 ... 20.1
9	22.3 ... 22.7
10	24.8 ... 25.2

Package

Miniature Array, Epoxy

Approximate Weight:

0.2 g

TTW Soldering

IEC-61760-1 TTW

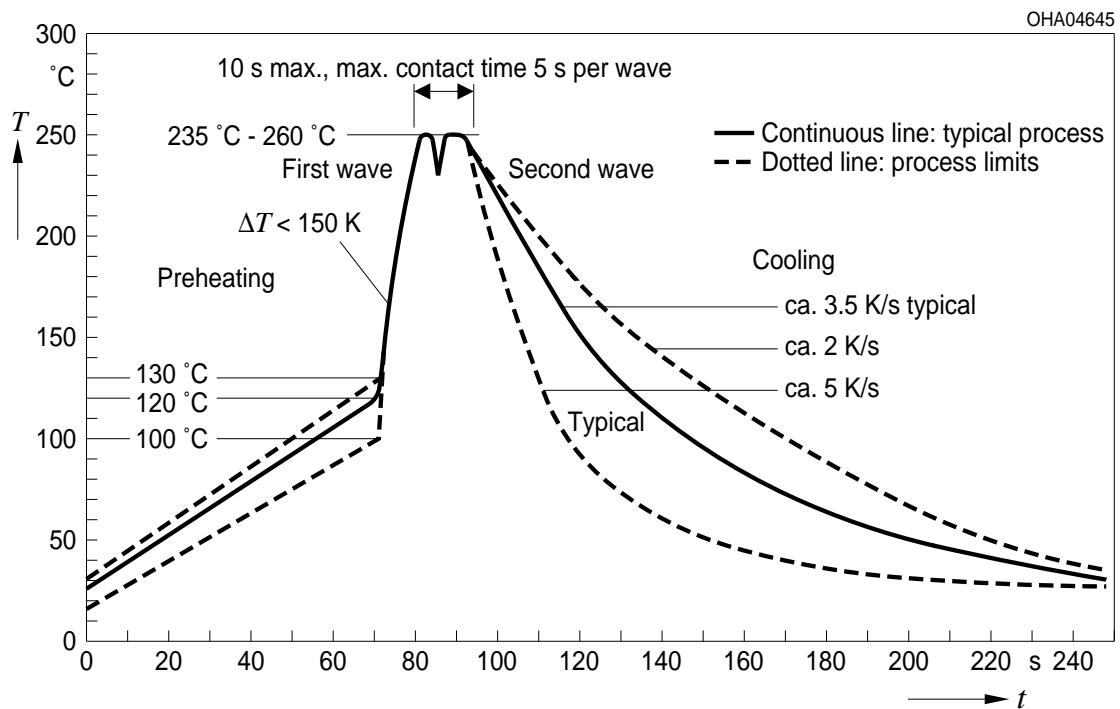

Disclaimer

Language english will prevail in case of any discrepancies or deviations between the two language wordings.

Attention please!

The information describes the type of component and shall not be considered as assured characteristics.

Terms of delivery and rights to change design reserved. Due to technical requirements components may contain dangerous substances.

For information on the types in question please contact our Sales Organization.

If printed or downloaded, please find the latest version in the Internet.

Packing

Please use the recycling operators known to you. We can also help you – get in touch with your nearest sales office.

By agreement we will take packing material back, if it is sorted. You must bear the costs of transport. For packing material that is returned to us unsorted or which we are not obliged to accept, we shall have to invoice you for any costs incurred.

Components used in life-support devices or systems must be expressly authorized for such purpose!

Critical components* may only be used in life-support devices** or systems with the express written approval of OSRAM OS.

*) A critical component is a component used in a life-support device or system whose failure can reasonably be expected to cause the failure of that life-support device or system, or to affect its safety or the effectiveness of that device or system.

**) Life support devices or systems are intended (a) to be implanted in the human body, or (b) to support and/or maintain and sustain human life. If they fail, it is reasonable to assume that the health and the life of the user may be endangered.

Glossary

- ¹⁾ **Typical Values:** Due to the special conditions of the manufacturing processes of LED, the typical data or calculated correlations of technical parameters can only reflect statistical figures. These do not necessarily correspond to the actual parameters of each single product, which could differ from the typical data and calculated correlations or the typical characteristic line. If requested, e.g. because of technical improvements, these typ. data will be changed without any further notice.

Published by OSRAM Opto Semiconductors GmbH
Leibnizstraße 4, D-93055 Regensburg
www.osram-os.com © All Rights Reserved.

EU RoHS and China RoHS compliant product



此产品符合欧盟 RoHS 指令的要求；
按照中国的相关法规和标准，不含有毒有害物质或元素。



Компания «ЭлектроПласт» предлагает заключение долгосрочных отношений при поставках импортных электронных компонентов на взаимовыгодных условиях!

Наши преимущества:

- Оперативные поставки широкого спектра электронных компонентов отечественного и импортного производства напрямую от производителей и с крупнейших мировых складов;
- Поставка более 17-ти миллионов наименований электронных компонентов;
- Поставка сложных, дефицитных, либо снятых с производства позиций;
- Оперативные сроки поставки под заказ (от 5 рабочих дней);
- Экспресс доставка в любую точку России;
- Техническая поддержка проекта, помощь в подборе аналогов, поставка прототипов;
- Система менеджмента качества сертифицирована по Международному стандарту ISO 9001;
- Лицензия ФСБ на осуществление работ с использованием сведений, составляющих государственную тайну;
- Поставка специализированных компонентов (Xilinx, Altera, Analog Devices, Intersil, Interpoint, Microsemi, Aeroflex, Peregrine, Syfer, Eurofarad, Texas Instrument, Miteq, Cobham, E2V, MA-COM, Hittite, Mini-Circuits, General Dynamics и др.);

Помимо этого, одним из направлений компании «ЭлектроПласт» является направление «Источники питания». Мы предлагаем Вам помощь Конструкторского отдела:

- Подбор оптимального решения, техническое обоснование при выборе компонента;
- Подбор аналогов;
- Консультации по применению компонента;
- Поставка образцов и прототипов;
- Техническая поддержка проекта;
- Защита от снятия компонента с производства.



Как с нами связаться

Телефон: 8 (812) 309 58 32 (многоканальный)

Факс: 8 (812) 320-02-42

Электронная почта: org@eplast1.ru

Адрес: 198099, г. Санкт-Петербург, ул. Калинина, дом 2, корпус 4, литера А.