

Altech's Eurostrips are safe, economical and meet worldwide standards. They are a cost-effective alternative to barrier strips that require labor-intensive wire lugs and they reduce the number of electrical connections in circuits.

Eurostrips feature tubular screw clamps, wire protectors, and are ready for immediate wire hookup. Eurostrips are ideal in small spaces, which means more room for other components or reduced enclosure size. Free float or mount them onto any panel. They are available in easy-to-cut 12-pole strips or pre-cut.

Feed-Through Eurostrips are supplied with wire protectors. Offered with flat bases or standoff feet, they are molded of self-extinguishing polyamide. Custom imprinting and marking plates are available.

# EUROSTRIPS®

## EASY MOUNTING SAVES INSTALLATION TIME

Eurostrips are mounted quickly in panels. Use standard screws or mounting pins, offered as accessories in this section, or leave them free floating to completely eliminate mounting.

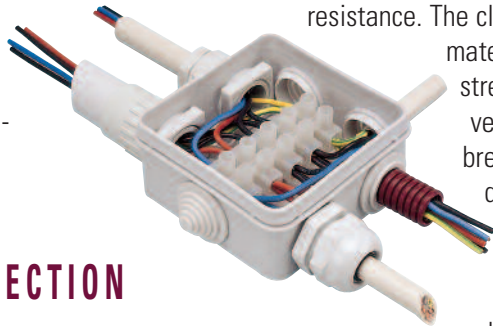

## EASY CONNECTION SAVES MONEY

What could be easier? Simply strip the wire insulation, insert the wire and tighten the screw to achieve a gas-tight, electrically efficient connection—every time. Wire lugs are eliminated, saving material cost and installation time.

## EASY MODIFICATION REDUCES INVENTORY

Offered in easy to cut 12 pole strips, they can also be ordered pre-cut with the required number of poles. Polyamide housing can be cut with a utility knife or hacksaw, providing flexibility to meet changing needs. Because standard 12 pole strips can be so easily cut to the required number of poles, stocking is simplified and inventory is minimized.

## RELIABLE CONNECTION EVERY TIME

The basis for the Eurostrip's reliable connection is a precision machined tubular screw clamp insert made from highly conductive copper alloy which is nickel plated for maximum corrosion resistance. The clamping screw material is high

strength steel to prevent screw head breakage or thread damage. This provides trouble free operation.

Screws are electrogalvanized and

bluechromated to provide corrosion resistance. Optional nickel plated brass screws may be ordered for highly corrosive environments or marine applications.

Standard Eurostrips feature stainless steel wire protectors. Unlike wire protectors found in many competitive products which use copper alloy materials, stainless steel has superior memory characteristics. Accordingly, the wire protector will return to its original position even after repeated use. This means trouble-free wire insertion and quicker reconnections.

## HOUSINGS

Eurostrip housings are injection molded from self-extinguishing polyamide 6.6 molding material, possessing high dielectric strength and excellent electrical insulation and temperature resistance. Each housing has been specially designed to provide creepage and clearance distances to achieve ratings up to 600V. Choose low profile, flat base housings for minimum clearance applications (300V) or housings with mounting feet for maximum voltage isolation (600V).

## ACCESSORIES

External jumpers bus potentials between poles on Eurostrips, eliminating wire jumpers and reducing wiring time. Isolation partition increases clearance between adjacent poles and provides visual separation for more efficient wiring. Mounting pins simplify installation and mounting of Eurostrips. Simply drill the mounting hole, position and install the pin from underneath the panel. When correct position is reached, pin will retain terminal to panel.

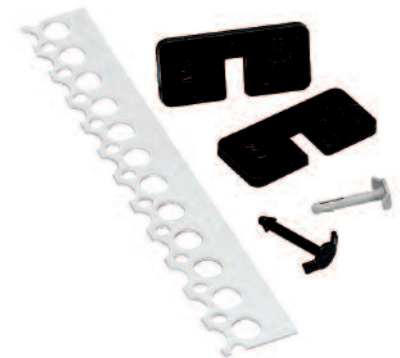

Identify circuits and reduce wiring mistakes with marking plates. Order plates imprinted or blank. Position under or on top of a Eurostrip housing.

Imprinting Eurostrips reduces wiring errors and helps to identify circuits. Use Imprinting to mark individual poles when high quantities are involved or custom imprints are required.

## FEED-THROUGH FLAT BASE EUROSTRIPS Panel Mount

For wire-to-wire connections in HVAC, appliance, equipment, power distribution and other industrial applications with strict budget and space requirements. Easy to use double row terminal strips are a cost-effective alternative to barrier strips or other types of terminal blocks. Simply strip the wire, insert and tighten the screw. Eurostrips feature tubular screw clamps, with wire protectors, and recessed metal parts for finger protection. The stainless steel wire protectors exhibit excellent memory and the most effective connection.

Eurostrips described on this and the following page are available with a flat base for minimum clearance applications. They can be panel mounted or left to free float. Offered in easy to cut standard 12 pole strips, they can also be ordered precut with the required number of poles.

- Tubular screw clamp
- Panel mount or free float
- Housing material: polyamide 6.6
- Color: opaque white
- Marking plates or factory imprinted application



Flat base with wire protector



Flat base with wire protector

Pole Spacing	8 mm		10 mm	
Mounting Hole Diameter	3 mm		3.6 mm	
Stripping Length	5 mm		6 mm	
Approvals				
Wire Range	1-2.5 mm <sup>2</sup>	24-12 AWG	2.5-4 mm <sup>2</sup>	24-10 AWG
Voltage Rating	400 V	300 V	400V	300 V
Current Rating	6 A	20 A	10 A	30 A
Torque	0.5 Nm	4.4 lb-in	0.8 Nm	7.0 lb-in

No. of Poles	Cat. No.	Std. Pk.	Cat. No.	Std. Pk.
2	HE1WPR/02	100	HE4WPR/02	100
3	HE1WPR/03	100	HE4WPR/03	100
4	HE1WPR/04	100	HE4WPR/04	100
5	HE1WPR/05	100	HE4WPR/05	100
6	HE1WPR/06	50	HE4WPR/06	50
7	HE1WPR/07	50	HE4WPR/07	50
8	HE1WPR/08	50	HE4WPR/08	50
9	HE1WPR/09	50	HE4WPR/09	50
10	HE1WPR/10	50	HE4WPR/10	50
11	HE1WPR/11	50	HE4WPR/11	50
12	HE1WPR/12	50	HE4WPR/12	50

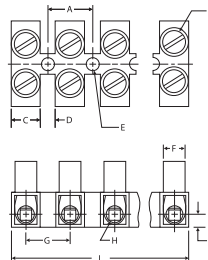

Dimensions mm

A = 8.0	H = Ø2.8
B = M2.6	I = 2.8
C = 5.2	J = 6.5
D = 2.8	K = 6.5
E = Ø3	L = 94 (12 pole)
F = Ø5	M = 12.2
G = 8.0	N = 16.2

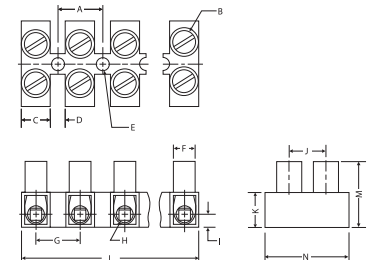

Dimensions mm

A = 10.0	H = Ø3.6
B = M3	I = 3.2
C = 6.4	J = 8.5
D = 3.5	K = 7.9
E = Ø3.6	L = 117 (12 pole)
F = Ø5.7	M = 14.9
G = 10.0	N = 20.0

## HE6

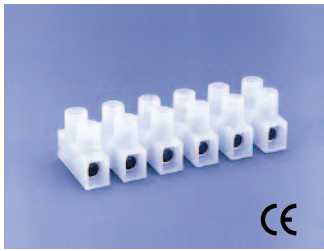

Flat base with wire protector

12 mm

4.2 mm

7 mm



4-6 mm<sup>2</sup>

20-10 AWG

400V

300 V

16 A

40 A

0.8 Nm

7.0 lb-in

Cat. No.	Std. Pk.
HE6WPR/02	100
HE6WPR/03	100
HE6WPR/04	100
HE6WPR/05	100
HE6WPR/06	50
HE6WPR/07	50
HE6WPR/08	50
HE6WPR/09	50
HE6WPR/10	25
HE6WPR/11	25
HE6WPR/12	25

## HE10

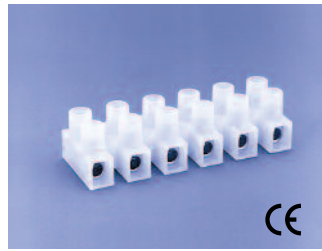

Flat base with wire protector

15 mm

4.3 / 5.7 mm

8.5 mm



6-10 mm<sup>2</sup>

18-8 AWG

400V

300 V

25 A

50 A

1.2 Nm

10.6 lb-in

Cat. No.	Std. Pk.
HE10WPR/02	50
HE10WPR/03	50
HE10WPR/04	50
HE10WPR/05	50
HE10WPR/06	25
HE10WPR/07	25
HE10WPR/08	25
HE10WPR/09	25
HE10WPR/10	10
HE10WPR/11	10
HE10WPR/12	10

## HE16

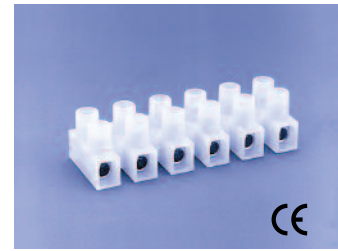

Flat base with wire protector

15 mm

4.3 / 5.7 mm

8.5 mm



10-16 mm<sup>2</sup>

18-6 AWG

400 V

300 V

35-63 A

63 A

2.0 Nm

17.7 lb-in

Cat. No.	Std. Pk.
HE16WPR/02	50
HE16WPR/03	50
HE16WPR/04	50
HE16WPR/05	50
HE16WPR/06	25
HE16WPR/07	25
HE16WPR/08	25
HE16WPR/09	25
HE16WPR/10	10
HE16WPR/11	10
HE16WPR/12	10

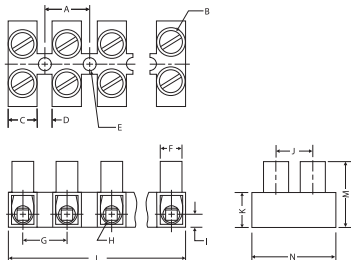

Dimensions mm

A = 12.0	H = Ø4.1
B = M3.5	I = 4.0
C = 7.7	J = 9.5
D = 4.3	K = 8.9
E = Ø4.2	L = 140 (12 pole)
F = Ø6.3	M = 16.8
G = 12.0	N = 22.6

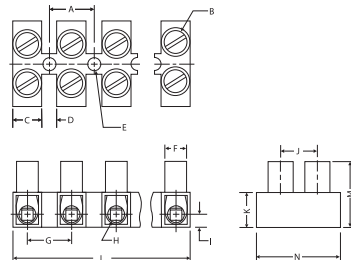

Dimensions mm

A = 15.0	H = Ø5.0
B = M4	I = 4.8
C = 9.3	J = 11.3
D = 5.7	K = 11.6
E = Ø4.3/5.7	L = 175 (12 pole)
F = Ø8.2	M = 21.9
G = 15.0	N = 25.1

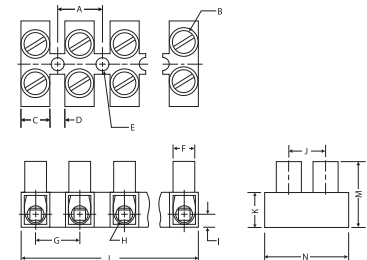

Dimensions mm

A = 15.0	H = Ø5.6
B = M5	I = 4.8
C = 9.3	J = 11.3
D = 5.7	K = 11.6
E = Ø4.3/5.7	L = 175 (12 pole)
F = Ø8.2	M = 21.9
G = 15.0	N = 25.1



## FEED THROUGH STANDOFF FEET EUROSTRIPS Panel Mount

For wire-to-wire connections in HVAC, appliance, equipment, power distribution and other industrial applications with restricted budget and space requirements.

Easy to use feed through terminal strips are a cost-effective alternative to barrier strips or other types of terminal blocks. Simply strip the wire, insert, and tighten the screw. Eurostrips feature tubular screw clamps, with wire protectors, and recessed metal parts for finger protection. The stainless steel wire protectors exhibit excellent memory and the most effective connection.

Eurostrips described on this and the preceding page are available with standoff feet for increased wiring efficiency. They can be panel mounted or left to free float. Offered in easy to cut 12 pole strips, they can also be ordered pre-cut with the required number of poles.

- Tubular screw clamp
- Panel mount or free float
- Housing material: polyamide 6.6
- Color: opaque white
- Marking plates or factory imprinted

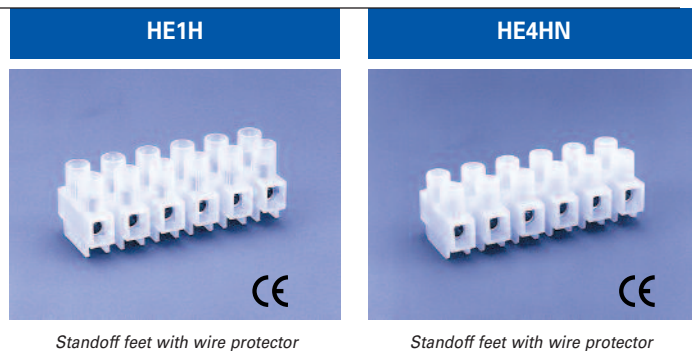

Standoff feet with wire protector

Standoff feet with wire protector

Pole Spacing	8 mm		10 mm	
Mounting Hole Diameter	3 mm		3.6 mm	
Stripping Length	5 mm		6 mm	
Approvals				
Wire Range	1-2.5 mm <sup>2</sup>	24-12 AWG	2.5-4 mm <sup>2</sup>	24-10 AWG
Voltage Rating	400 V	600 V	400 V	600 V
Current Rating	6 A	20 A	10 A	30 A
Torque	0.5 Nm	4.4 lb-in	0.8 Nm	7.0 lb-in

No. of Poles	Cat. No.	Std. Pk.	Cat. No.	Std. Pk.
2	HE1HWPR/02	100	HE4HNWPR/02	100
3	HE1HWPR/03	100	HE4HNWPR/03	100
4	HE1HWPR/04	100	HE4HNWPR/04	100
5	HE1HWPR/05	100	HE4HNWPR/05	100
6	HE1HWPR/06	50	HE4HNWPR/06	50
7	HE1HWPR/07	50	HE4HNWPR/07	50
8	HE1HWPR/08	50	HE4HNWPR/08	50
9	HE1HWPR/09	50	HE4HNWPR/09	50
10	HE1HWPR/10	50	HE4HNWPR/10	50
11	HE1HWPR/11	50	HE4HNWPR/11	50
12	HE1HWPR/12	50	HE4HNWPR/12	50

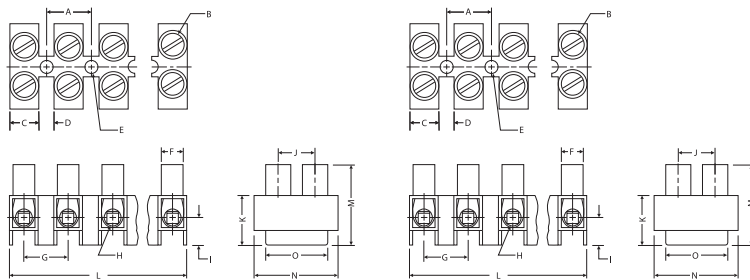

Dimensions mm

Dimensions mm

A = 8.0	I = 6.6
B = M2.6	J = 6.5
C = 5.2	K = 10.3
D = 2.8	L = 94 (12 pole)
E = Ø3	M = 16
F = Ø5	N = 16.2
G = 8.0	O = 10.1
H = Ø2.8	

A = 10.0	I = 6.7
B = M3	J = 8.5
C = 6.4	K = 12.1
D = 3.5	L = 117 (12 pole)
E = Ø3.6	M = 19.1
F = Ø5.7	N = 20
G = 10.0	O = 14.0
H = Ø3.6	

## HE6H

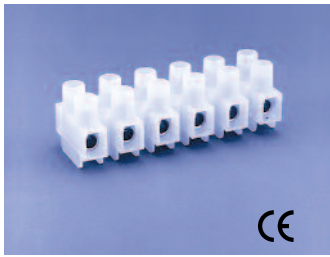

Standoff feet with wire protector

12 mm

4.2 mm

7 mm



4-6 mm<sup>2</sup>

20-10 AWG

400 V

600 V

16 A

40 A

0.8 Nm

7.0 lb-in

## HE10H

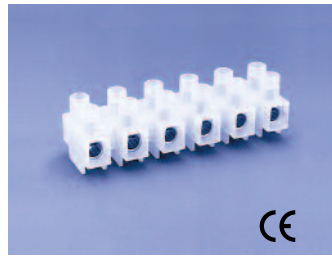

Standoff feet with wire protector

15 mm

4.3/5.7 mm

8.5 mm



6-10 mm<sup>2</sup>

18-8 AWG

400 V

600 V

25 A

50 A

1.2 Nm

10.6 lb-in

## HE16H

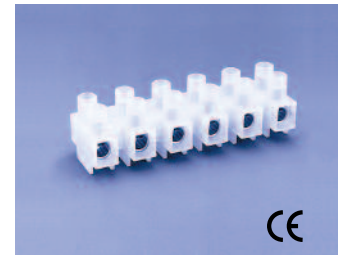

Standoff feet with wire protector

15 mm

4.3/5.7 mm

8.5 mm



10-16 mm<sup>2</sup>

18-6 AWG

400 V

600 V

35-63 A

63 A

2.0 Nm

17.7 lb-in

Cat. No.	Std. Pk.
HE6HWPR/02	100
HE6HWPR/03	100
HE6HWPR/04	100
HE6HWPR/05	100
HE6HWPR/06	50
HE6HWPR/07	50
HE6HWPR/08	50
HE6HWPR/09	50
HE6HWPR/10	25
HE6HWPR/11	25
HE6HWPR/12	25

Cat. No.	Std. Pk.
HE10HWPR/02	40
HE10HWPR/03	40
HE10HWPR/04	40
HE10HWPR/05	40
HE10HWPR/06	20
HE10HWPR/07	20
HE10HWPR/08	20
HE10HWPR/09	10
HE10HWPR/10	10
HE10HWPR/11	10
HE10HWPR/12	10

Cat. No.	Std. Pk.
HE16HWPR/02	40
HE16HWPR/03	40
HE16HWPR/04	40
HE16HWPR/05	40
HE16HWPR/06	20
HE16HWPR/07	20
HE16HWPR/08	20
HE16HWPR/09	10
HE16HWPR/10	10
HE16HWPR/11	10
HE16HWPR/12	10

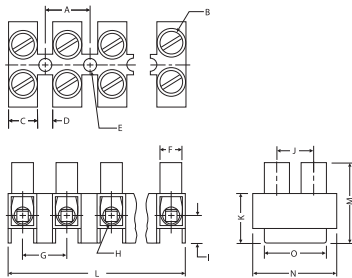

Dimensions mm

A = 12.0  
B = M3.5  
C = 7.7  
D = 4.3  
E = Ø4.2  
F = Ø6.3  
G = 12.0  
H = Ø4.1  
I = 9  
J = 9.6  
K = 13.9  
L = 140 (12 pole)  
M = 21.8  
N = 22.6  
O = 15

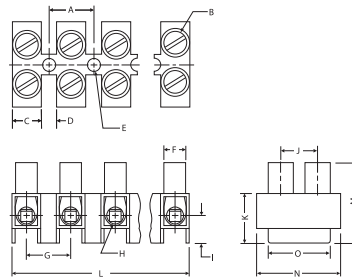

Dimensions mm

A = 15.0  
B = M4  
C = 9.3  
D = 5.7  
E = Ø4.3/5.7  
F = Ø8.2  
G = 15.0  
H = Ø5.0  
I = 10.7  
J = 11.3  
K = 17.5  
L = 175 (12 pole)  
M = 27.8  
N = 25.1  
O = 16

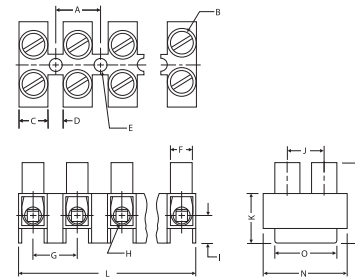

Dimensions mm

A = 15.0  
B = M5  
C = 9.3  
D = 5.7  
E = Ø4.3/5.7  
F = Ø8.2  
G = 15.0  
H = Ø5.6  
I = 10.7  
J = 11.3  
K = 17.5  
L = 175 (12 pole)  
M = 27.8  
N = 25.1  
O = 16

## PLUGGABLE EUROSTRIPS Panel Mount

For wire-to-wire connections in HVAC, appliance, equipment, power and other distribution applications. Pluggable Eurostrips® speed and simplify replacement of subassemblies, etc. They reduce downtime and misconnections.

Two-piece pluggable terminal strips feature tubular screw clamps, with recessed metal parts for finger protection. A spring loaded contact prevents inadvertent unplugging.

The headers and plugs are available with flat base or standoff feet and can be panel mounted or free float. Offered in easy to cut 12 pole strips, they can also be orderd precut with the required number of poles.

- Tubular Screw Clamp
- Panel Mount or Free Float
- Housing Material: Polyamide 6.6
- Color: Opaque White

### FLAT BASE

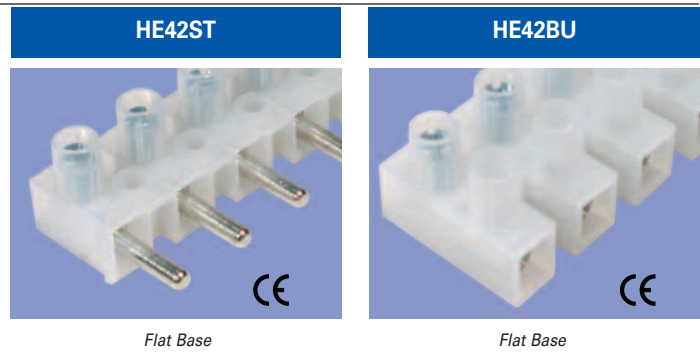

Flat Base

Flat Base

Pole Spacing	10 mm		10 mm	
Mounting Hole Diameter	3.5 mm		3.5 mm	
Stripping Length	3.6 mm		3.6 mm	
Approvals				
Wire Range	2.5-4mm <sup>2</sup>	24-10AWG	2.5-4mm <sup>2</sup>	24-10AWG
Voltage Rating	400V	300V	400V	300V
Current Rating	10A	20A	10A	20A
Torque	0.8Nm	7.2lb	0.8Nm	7.2lb

No. of Poles	Cat. No.	Std. Pk.	Cat. No.	Std. Pk.
2	HE42ST/02	100	HE42BU/02	100
3	HE42ST/03	100	HE42BU/03	100
4	HE42ST/04	100	HE42BU/04	100
5	HE42ST/05	100	HE42BU/05	100
6	HE42ST/06	50	HE42BU/06	50
7	HE42ST/07	50	HE42BU/07	50
8	HE42ST/08	50	HE42BU/08	50
9	HE42ST/09	50	HE42BU/09	50
10	HE42ST/10	50	HE42BU/10	50
11	HE42ST/11	50	HE42BU/11	50
12	HE42ST/12	50	HE42BU/12	50

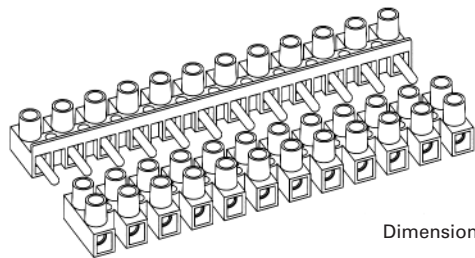

Dimensions mm

A = 10.0	J = 15.2
B = M3	K = 7.9
C = 6.4	L = 117
D = 3.6	M = 14.9
E = Ø3.5	N = 34.4
F = Ø5.7	O = 9.2
G = 10.0	P = 20
H = Ø3.5	Q = 14.4
I = 3.2	R = 7

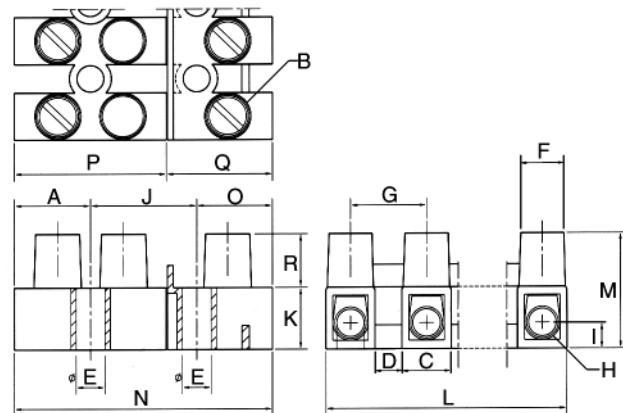

## STANDOFF FEET

HE42SST

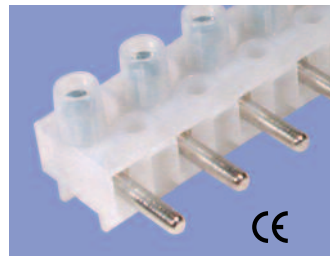





Standoff feet

HE42SBU



Standoff feet

Pole Spacing	10 mm		10 mm	
Mounting Hole Diameter	3.5 mm		3.5 mm	
Stripping Length	3.6 mm		3.6 mm	
Approvals	 		 	
Wire Range	2.5-4mm <sup>2</sup>	24-10AWG	2.5-4mm <sup>2</sup>	24-10AWG
Voltage Rating	400V	600V	400V	600V
Current Rating	10A	20A	10A	20A
Torque	0.8Nm	7.2lb	0.8Nm	7.2lb
<b>No. of Poles</b>	<b>Cat. No.</b>	<b>Std. Pk.</b>	<b>Cat. No.</b>	<b>Std. Pk.</b>
2	HE42SST/02	100	HE42SBU/02	100
3	HE42SST/03	100	HE42SBU/03	100
4	HE42SST/04	100	HE42SBU/04	100
5	HE42SST/05	100	HE42SBU/05	100
6	HE42SST/06	50	HE42SBU/06	50
7	HE42SST/07	50	HE42SBU/07	50
8	HE42SST/08	50	HE42SBU/08	50
9	HE42SST/09	50	HE42SBU/09	50
10	HE42SST/10	50	HE42SBU/10	50
11	HE42SST/11	50	HE42SBU/11	50
12	HE42SST/12	50	HE42SBU/12	50

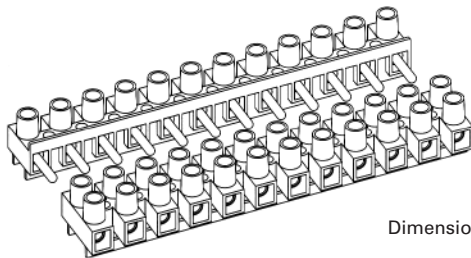

Dimensions mm

A = 10.0	J = 15.2
B = M3	K = 11.5
C = 6.4	L = 117
D = 3.6	M = 18.5
E = Ø3.5	N = 34.4
F = Ø5.7	O = 9.2
G = 10.0	P = 20
H = Ø3.5	Q = 14.4
I = 6.8	R = 7

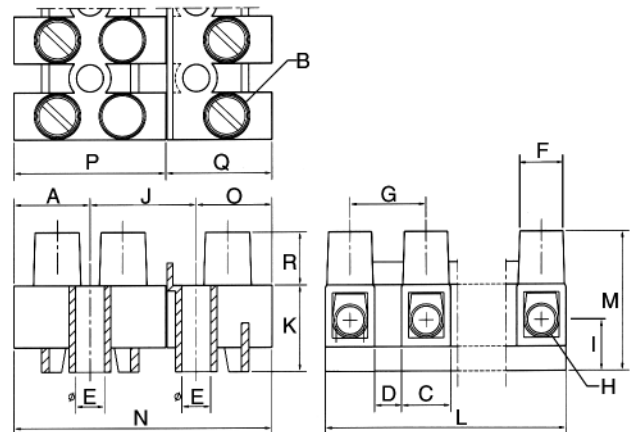



# EUROSTRIP ACCESSORIES

Convenient options that facilitate installation and wire termination.

## External Jumpers

Bus potentials between poles on Eurostrip Terminal Strips reducing wiring time and eliminating wire jumpers.

Jumper Pole positions may be removed to provide selective jumpering. When using external jumpers, the terminal's rated cross section is usually reduced one wire size. For jumper maximum current ratings, refer to the corresponding Eurostrip IEC/VDE current rating.

- Material: copper alloy, nickel plated
- Insulation: polyamide 6.6
- Color: black.

## EXTERNAL JUMPERS



External Jumper	HCL8	HCL10	HCL12	HCL15				
Eurostrip	HE1	HE4	HE6	HE10, HE16				
Pole Spacing	8mm (.315)	10 mm (.394 in.)	12 mm (.472)	15 mm (.591 in.)				
Ordering Information	Cat. No.	Std. Pk.	Cat. No.	Std. Pk.	Cat. No.	Std. Pk.	Cat. No.	Std. Pk.
2 pole	HCL8-2	100	HCL10-2	100	HCL12-2	100	HCL15-2	100
3 pole	HCL8-3	100	HCL10-3	100	HCL12-3	100	HCL15-3	100
4 pole	HCL8-4	100	HCL10-4	100	HCL12-4	100	HCL15-4	100
12 pole	HCL8-12	25	HCL10-12	25	HCL12-12	25	HCL15-12	25

## Isolation Partitions

Isolation Partition KA provides separation between adjacent poles of different potentials on 600V Eurostrips with standoff feet. Visual separation between poles is also provided by an isolation partition, assisting circuit identification and increasing wiring efficiency

- Material: polyamide 6.6
- Color: black

## ISOLATION PARTITION

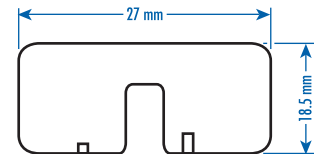
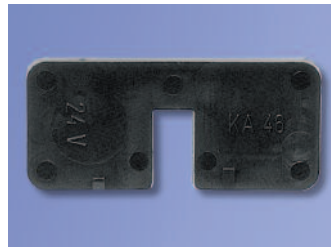

Isolation Partition	KA46	
Eurostrip	HE4HN, HE6H	
Thickness	3.4 mm (.134 in.)	
Ordering Information	Cat. No.	Std. Pk.
	HEP4/6H	5

## EUROSTRIP ACCESSORIES

Convenient options that facilitate installation and wire termination.

### Mounting Pins

Speed panel mounting of Eurostrips with Mounting Pins. Simply match drill clearance hole in panel, position Eurostrip and install Mounting Pin through hole and into mounting hole in Eurostrip housing. Once pin passes beyond Eurostrip housing, it automatically expands, securing housing to panel. Use two or more mounting pins per Eurostrip.

- Material: polycarbonate
- Color: gray.

### Marking Plates

Install Marking Plate MP under or on top of Eurostrip housing to identify individual pole positions to increase wiring efficiency, save installation time and facilitate wire hook-up, system modification and trouble shooting. Select blank marking plate for hand marking or imprinted.

- Material: self-extinguishing PVC
- Color: white with black imprint.

### Imprinting

Mark individual pole positions to save installation time and facilitate wire hook-up, system modification and trouble shooting. Choose turret marking for optimum identification. To order imprinting specify consecutive, identical or custom character imprints.

- Imprints: rub-resistant, black ink.

## MOUNTING PINS

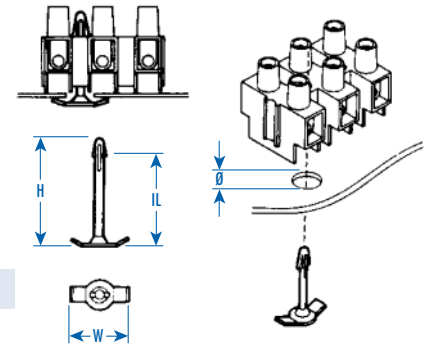

Mounting Pins	H4	H6		
Eurostrip	HE4HN	HE6H		
Panel Thickness	0.5-1.5 mm	0.8-1.8 mm		
Ordering Information	Cat. No.	Std. Pk	Cat. No.	Std. Pk.
	H4	50	H6	50

Mounting Pin Type	Dimensions mm (in.)			
	Pin Height (H)	Insertion Length (IL)	Panel Hole Dia.	Width (W)
H4	21	12.6	4.2	8.5
H6	24	14.7	5.2	11

## MARKING PLATES

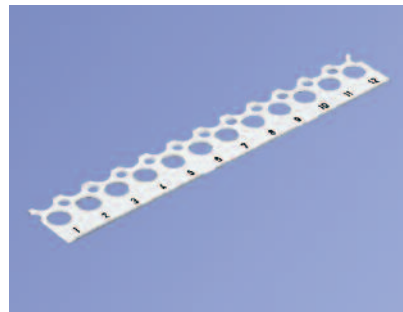

Eurostrip	HE4, HE4HN			HE6, HE6H			HE10, HE10H, HE16, HE16H		
Ordering Information	Cat. No.	Desc.	Std. Pk	Cat. No.	Desc.	Std. Pk.	Cat. No.	Desc.	Std. Pk.
	BS24E	Blank	25	BS60E	Blank	25	BS1016E	Blank	25
	BS24EM1-12	No. 1-12	25	BS60EM1-12	No. 1-12	25	BS1016EM1-12	No. 1-12	25
	BS24EM13-24	No. 13-24	25	BS60EM13-24	No. 13-24	25	BS1016EM13-24	No. 13-24	25

## IMPRINTING



Turret Location

Imprint	Turret Location	
Marking Instruction	Consecutive, imprint 1 through 12, Turret Location	
Ordering Example	Cat. No.	Std. Pk.
	HE4WPR/1211-12	1000



Компания «ЭлектроПласт» предлагает заключение долгосрочных отношений при поставках импортных электронных компонентов на взаимовыгодных условиях!

Наши преимущества:

- Оперативные поставки широкого спектра электронных компонентов отечественного и импортного производства напрямую от производителей и с крупнейших мировых складов;
- Поставка более 17-ти миллионов наименований электронных компонентов;
- Поставка сложных, дефицитных, либо снятых с производства позиций;
- Оперативные сроки поставки под заказ (от 5 рабочих дней);
- Экспресс доставка в любую точку России;
- Техническая поддержка проекта, помощь в подборе аналогов, поставка прототипов;
- Система менеджмента качества сертифицирована по Международному стандарту ISO 9001;
- Лицензия ФСБ на осуществление работ с использованием сведений, составляющих государственную тайну;
- Поставка специализированных компонентов (Xilinx, Altera, Analog Devices, Intersil, Interpoint, Microsemi, Aeroflex, Peregrine, Syfer, Eurofarad, Texas Instrument, Miteq, Cobham, E2V, MA-COM, Hittite, Mini-Circuits, General Dynamics и др.);

Помимо этого, одним из направлений компании «ЭлектроПласт» является направление «Источники питания». Мы предлагаем Вам помощь Конструкторского отдела:

- Подбор оптимального решения, техническое обоснование при выборе компонента;
- Подбор аналогов;
- Консультации по применению компонента;
- Поставка образцов и прототипов;
- Техническая поддержка проекта;
- Защита от снятия компонента с производства.



#### Как с нами связаться

**Телефон:** 8 (812) 309 58 32 (многоканальный)

**Факс:** 8 (812) 320-02-42

**Электронная почта:** [org@eplast1.ru](mailto:org@eplast1.ru)

**Адрес:** 198099, г. Санкт-Петербург, ул. Калинина, дом 2, корпус 4, литера А.