

PART NUMBER	SSP-DM0	REV.	A
DATE	E.C.N. NUMBER AND REVISION COMMENTS		REV.
02.28.12	E.C.N. #11809.		A

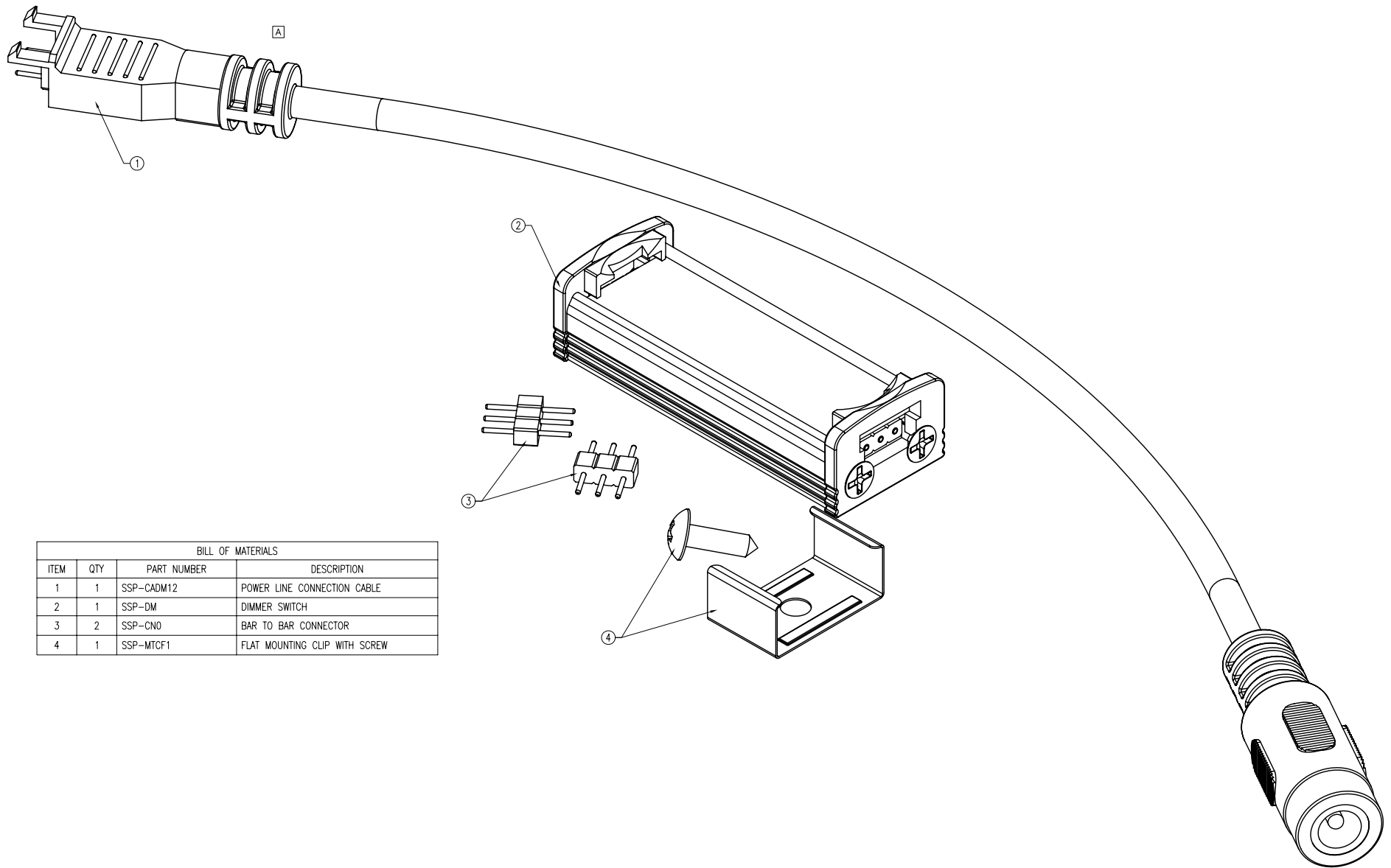

BILL OF MATERIALS			
ITEM	QTY	PART NUMBER	DESCRIPTION
1	1	SSP-CADM12	POWER LINE CONNECTION CABLE
2	1	SSP-DM	DIMMER SWITCH
3	2	SSP-CN0	BAR TO BAR CONNECTOR
4	1	SSP-MTCF1	FLAT MOUNTING CLIP WITH SCREW

\*UNLESS OTHERWISE SPECIFIED TOLERANCES PER DECIMAL PRECISION ARE: X=±1 (±0.039), X.X=±0.5 (±0.020), X.XX=±0.25 (±0.010), X.XXX=±0.127 (±0.005). LEAD SIZE=±0.05 (±0.002), LEAD LENGTH=±0.75 (±0.030). MIN.= <sup>+0.00</sup>DECIMAL PRECISION MAX.= <sup>+0.00</sup>DECIMAL PRECISION <sub>-0.00</sub>DECIMAL PRECISION

**LUMEX**  
 Creating LED and LCD Solutions Together™  
 290 E. HELEN ROAD  
 PALATINE, IL 60067-6976  
 PHONE: +1.847.359.2790  
 FAX: +1.847.359.6538  
 WEB: WWW.LUMEX.COM

SUNBRITE DIMMER SWITCH KIT FOR MODULAR LED LIGHTBAR.

\*\*THE SPECIFICATIONS MAY CHANGE AT ANY TIME WITHOUT NOTICE DUE TO NEW MATERIALS OR PRODUCT IMPROVEMENT.\*\*

CONFIDENTIAL INFORMATION  
 THE INFORMATION CONTAINED IN THIS DOCUMENT IS THE PROPERTY OF LUMEX INC. EXCEPT AS SPECIFICALLY AUTHORIZED IN WRITING BY LUMEX INC., THE HOLDER OF THIS DOCUMENT SHALL KEEP ALL INFORMATION CONTAINED HEREIN CONFIDENTIAL AND SHALL PROTECT SAME IN WHOLE OR IN PART FROM DISCLOSURE AND DISSEMINATION TO ALL THIRD PARTIES.

DATE:	07.13.11	DRAWN BY:	AB
PAGE:	1 OF 3	CHKD BY:	KF
SCALE:	NTS	APRVD BY:	KF
UNIT:	mm [INCH]		Ⓟ

PART NUMBER	SSP-DMO	REV.	A
DATE	E.C.N. NUMBER AND REVISION COMMENTS		REV.
02.28.12	E.C.N. #11809.		A

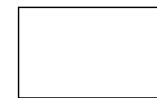
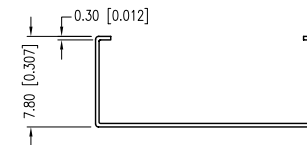
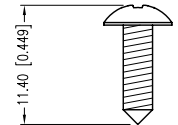
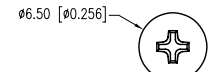
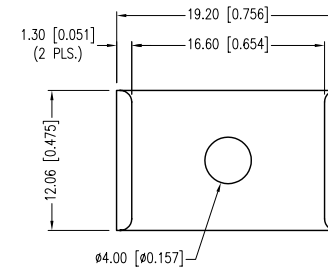
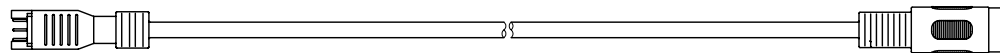
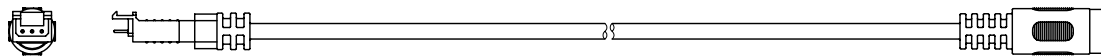
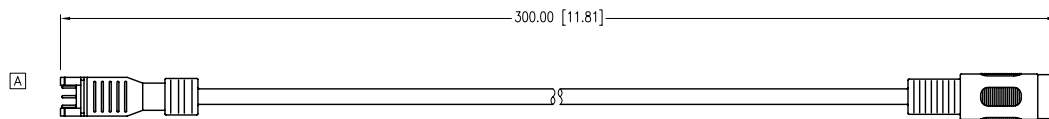
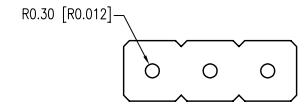
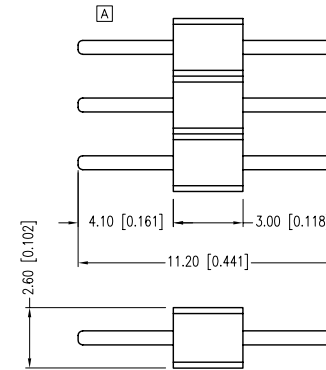
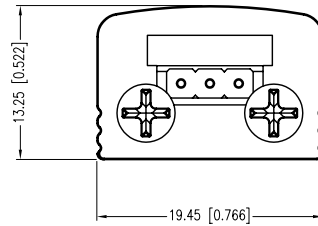
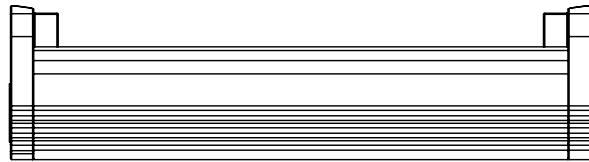

\*UNLESS OTHERWISE SPECIFIED TOLERANCES PER DECIMAL PRECISION ARE: X=±1 (±0.039), X.X=±0.5 (±0.020), X.XX=±0.25 (±0.010), X.XXX=±0.127 (±0.005). LEAD SIZE=±0.05 (±0.002), LEAD LENGTH=±0.75 (±0.030). MIN.= +<sup>DECIMAL PRECISION</sup> -<sub>DECIMAL PRECISION</sub>

**LUMEX**  
 Creating LED and LCD Solutions Together™

290 E. HELEN ROAD  
 PALATINE, IL 60067-6976  
 PHONE: +1.847.359.2790  
 FAX: +1.847.359.6538  
 WEB: WWW.LUMEX.COM

SUNBRITE DIMMER SWITCH KIT FOR MODULAR LED LIGHTBAR.

\*\*\*THE SPECIFICATIONS MAY CHANGE AT ANY TIME WITHOUT NOTICE DUE TO NEW MATERIALS OR PRODUCT IMPROVEMENT.\*\*

CONFIDENTIAL INFORMATION  
 THE INFORMATION CONTAINED IN THIS DOCUMENT IS THE PROPERTY OF LUMEX INC. EXCEPT AS SPECIFICALLY AUTHORIZED IN WRITING BY LUMEX INC., THE HOLDER OF THIS DOCUMENT SHALL KEEP ALL INFORMATION CONTAINED HEREIN CONFIDENTIAL AND SHALL PROTECT SAME IN WHOLE OR IN PART FROM DISCLOSURE AND DISSEMINATION TO ALL THIRD PARTIES.

DATE:	07.13.11	DRAWN BY:	AB
PAGE:	2 OF 3	CHKD BY:	KF
SCALE:	NTS	APRVD BY:	KF
UNIT:	mm [INCH]		Ⓟ

PART NUMBER	SSP-DM0	REV.	A
DATE	E.C.N. NUMBER AND REVISION COMMENTS		REV.
02.28.12	E.C.N. #11809.		A

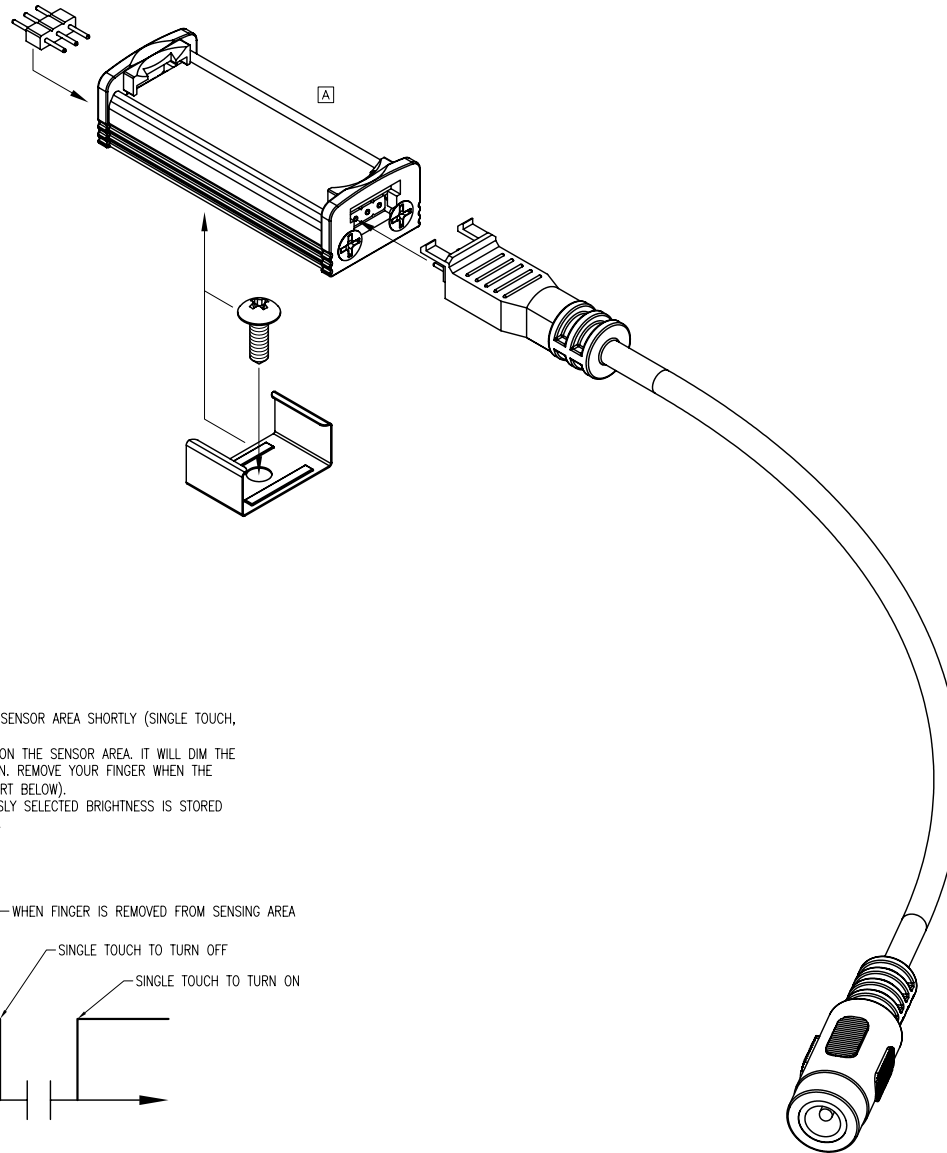

OPERATION DESCRIPTION

1. ON/OFF: USE YOUR FINGER TO TOUCH THE SENSOR AREA SHORTLY (SINGLE TOUCH, ~0.5 SECONDS, SEE CHART BELOW).
2. DIMMING: CONTINUE TO HOLD YOUR FINGER ON THE SENSOR AREA. IT WILL DIM THE LIGHTBAR BRIGHTNESS IN A CYCLING PATTERN. REMOVE YOUR FINGER WHEN THE DESIRED BRIGHTNESS IS ACHIEVED (SEE CHART BELOW).
3. BRIGHTNESS SETTING MEMORY: THE PREVIOUSLY SELECTED BRIGHTNESS IS STORED UNTIL THE ADAPTOR PLUG IS DISCONNECTED.

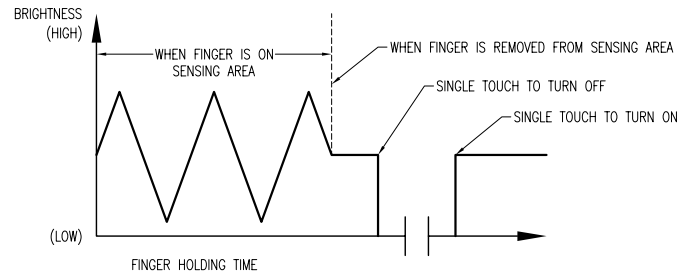

\*UNLESS OTHERWISE SPECIFIED TOLERANCES PER DECIMAL PRECISION ARE: X=±1 (±0.039), X.X=±0.5 (±0.020), X.XX=±0.25 (±0.010), X.XXX=±0.127 (±0.005). LEAD SIZE=±0.05 (±0.002), LEAD LENGTH=±0.75 (±0.030). MIN.= <sup>+0.00</sup> DECIMAL PRECISION MAX.= <sup>-0.00</sup> DECIMAL PRECISION



290 E. HELEN ROAD  
 PALATINE, IL 60067-6976  
 PHONE: +1.847.359.2790  
 FAX: +1.847.359.6538  
 WEB: WWW.LUMEX.COM

SUNBRITE DIMMER SWITCH KIT FOR MODULAR LED LIGHTBAR.

\*\*THE SPECIFICATIONS MAY CHANGE AT ANY TIME WITHOUT NOTICE DUE TO NEW MATERIALS OR PRODUCT IMPROVEMENT.\*\*

CONFIDENTIAL INFORMATION  
 THE INFORMATION CONTAINED IN THIS DOCUMENT IS THE PROPERTY OF LUMEX INC. EXCEPT AS SPECIFICALLY AUTHORIZED IN WRITING BY LUMEX INC., THE HOLDER OF THIS DOCUMENT SHALL KEEP ALL INFORMATION CONTAINED HEREIN CONFIDENTIAL AND SHALL PROTECT SAME IN WHOLE OR IN PART FROM DISCLOSURE AND DISSEMINATION TO ALL THIRD PARTIES.

DATE:	07.13.11	DRAWN BY:	AB
PAGE:	3 OF 3	CHKD BY:	KF
SCALE:	NTS	APRVD BY:	KF
UNIT:	mm [INCH]		Ⓟ



Компания «ЭлектроПласт» предлагает заключение долгосрочных отношений при поставках импортных электронных компонентов на взаимовыгодных условиях!

Наши преимущества:

- Оперативные поставки широкого спектра электронных компонентов отечественного и импортного производства напрямую от производителей и с крупнейших мировых складов;
- Поставка более 17-ти миллионов наименований электронных компонентов;
- Поставка сложных, дефицитных, либо снятых с производства позиций;
- Оперативные сроки поставки под заказ (от 5 рабочих дней);
- Экспресс доставка в любую точку России;
- Техническая поддержка проекта, помощь в подборе аналогов, поставка прототипов;
- Система менеджмента качества сертифицирована по Международному стандарту ISO 9001;
- Лицензия ФСБ на осуществление работ с использованием сведений, составляющих государственную тайну;
- Поставка специализированных компонентов (Xilinx, Altera, Analog Devices, Intersil, Interpoint, Microsemi, Aeroflex, Peregrine, Syfer, Eurofarad, Texas Instrument, Miteq, Cobham, E2V, MA-COM, Hittite, Mini-Circuits, General Dynamics и др.);

Помимо этого, одним из направлений компании «ЭлектроПласт» является направление «Источники питания». Мы предлагаем Вам помощь Конструкторского отдела:

- Подбор оптимального решения, техническое обоснование при выборе компонента;
- Подбор аналогов;
- Консультации по применению компонента;
- Поставка образцов и прототипов;
- Техническая поддержка проекта;
- Защита от снятия компонента с производства.



#### Как с нами связаться

**Телефон:** 8 (812) 309 58 32 (многоканальный)

**Факс:** 8 (812) 320-02-42

**Электронная почта:** [org@eplast1.ru](mailto:org@eplast1.ru)

**Адрес:** 198099, г. Санкт-Петербург, ул. Калинина, дом 2, корпус 4, литера А.