

EAO – Your Expert Partner for  
Human Machine Interfaces



## EAO Product Information

Series 04





|                                      |            |
|--------------------------------------|------------|
| <b>Description .....</b>             | <b>3</b>   |
| <b>Product Assembly .....</b>        | <b>4</b>   |
| <b>Mounting instruction .....</b>    | <b>10</b>  |
| <b>Devices raised mounting .....</b> | <b>12</b>  |
| <b>Devices flush mounting .....</b>  | <b>32</b>  |
| <b>Accessories.....</b>              | <b>48</b>  |
| <b>Spare Parts .....</b>             | <b>64</b>  |
| <b>Technical Data.....</b>           | <b>77</b>  |
| <b>Typical Applications .....</b>    | <b>84</b>  |
| <b>Application guidelines.....</b>   | <b>85</b>  |
| <b>Marking .....</b>                 | <b>86</b>  |
| <b>Drawings.....</b>                 | <b>91</b>  |
| <b>Index.....</b>                    | <b>122</b> |

## Product Information

### General notes

Series 04, a modular switching system, offers users a wide range of possible combinations. A broad variety of actuators is available, round or square in shape, for use as pushbuttons, keylock switches or lever-operated switches and indicators.

Other special actuators, such as mushroom heads or emergency-stop pushbuttons and buzzers can also be supplied.

Max. 3 switching elements, as snap-action or slow-make switches, can be clipped as modules to each actuator. Each switching element is equipped with 1 or 2 independent switching systems with normally closed or normally open contact.

Anodized aluminium parts can have visible variations due production-technical reasons.

### Mounting

The series 04 pushbuttons and switches in raised version are mounted in a 22.5 mm dia. cut-out or with appropriate adapter in 30.5 mm dia. mounting hole.

Flush mounted devices have a 30.5 mm dia. cutout or 30 x 30 mm.

### Terminals

The switching elements and the lamp blocks can be supplied with screw / plug-in terminals or push-in terminals.

### Lenses

Lenses of transparent plastic or aluminium are available in various standard colours.

### Marking

For further information about engraving, hot stamping and film inserts see part Marking.

### Illumination

The BA9s incandescent (filament) lamp (6, 12, 24, 36, 48, 60, 110, 130 V) ensures perfect illumination of the lenses, which are supplied in various colours.

BA9s Single-Chip LED (6, 12, 24, 28, 48 V) are also available in blue, green, red, white or yellow.

Luminosity and wave length scattering caused by the technology used in the LED manufacturing processes may lead to visual differences in our products.

### Position indication

The status of a maintained action switch can be determined by the position of the lens.

### Keylock switch

Standard lock number is 251, the last digit of Typ-Nr. = 0 (example : 704.335.0).

Additional lock numbers are available : 252 last digit = 1; 253 last digit = 2; 254 last digit = 3; 255 last digit = 4; 256 last digit = 5; 257 last digit = 6; 259 last digit = 8; 260 last digit = 9.

Two keys are supplied with each keylock switch.

### Keyinsert switch 704.095.0T28

EAO worked with the German Railways to develop an incredibly strong key-insert switch, which allows the conductor to close all the train's doors at the same time from any door using so called 'remote closing'. The switch, which has a 'massive' all-stainless steel construction, was modified from EAO's standard Series 04 switch to actuate the remote closing function with a single twist of the conductor's key; he can cancel or 'revoke' the remote closing with another twist of the key.

The important difference in the EAO design and the design of the switch they used previously is that it separates the function according to direction; accidental operation far less likely - twist one way for remote closing, twist the other way to cancel the remote closing.

The switch has a mechanical lifetime of 150 000 cycles and is incredibly durable to withstand the repeated use that might be necessary on every journey.

### Rotary selector switch

The rotary selector switch of series 04 are ideal control- and instrument switches. The switch types (CG4-1) are suitable particularly for switching of low tension. They correspond to the regulations after EN IEC 60947-3 and VDE 0660-Part 3.

By the special axial arrangement of the connecting terminals it is possible to mount the switches side by side or next to the cable duct. The contact marking remains well visible also in the mounted position. The required space of these switches is very small.

### Number structure

Nomenclature in accordance with ' CENELEC Certificate '. The certification document we dispatch to them on demands.

### Specimen order

#### Illuminated pushbutton:

- Illuminated pushbutton actuator, 30 x 30 mm 704.229.6  
Momentary action  
Front ring plastic black  
Lens plastic blue

#### Essential accessories:

- Single-Chip LED BA9s, 24 VAC/DC, blue 10-2512.1146
- Switching element, snap-action 704.900.5  
1 NC + 1 NO, hard silver  
screw terminal

*We reserve the right to modify technical data  
All dimensions in mm*

## Pushbutton, raised mounting



- 1 Front bezel
- 2 Lens
- 3 Marking foil
- 4 Lens holder
- 5 Actuator housing
- 6 Sealing
- 7 Front plate
- 8 Bayonet flange
- 9 Switching element

## Emergency-stop pushbutton



- 1 Emergency-stop pushbutton actuator
- 2 Sealing
- 3 Front plate
- 4 Bayonet flange
- 5 Switching element

## Keylock switch, raised mounting



- 1 Keylock switch actuator
- 2 Sealing
- 3 Front plate
- 4 Fixing nut
- 5 Switching element

## Rotary selector switch, raised mounting



- 1 Rotary selector switch actuator
- 2 Sealing
- 3 Front plate
- 4 Bayonet flange
- 5 Rotary switch element



## Indicator, flush mounting



- 1 Lens
- 2 Marking foil
- 3 Lens holder
- 4 LED
- 5 Actuator housing
- 6 Front plate
- 7 Pressure ring
- 8 Bayonet flange
- 9 Lamp element

## Pushbutton illuminated, flush mounting



- 1 Lens
- 2 Marking plate
- 3 LED
- 4 Actuator housing
- 5 Sealing
- 6 Front plate
- 7 Pressure ring
- 8 Bayonet flange
- 9 Lamp element
- 10 Switching element

## Selector switch, flush mounting



- 1 Selector switch actuator
- 2 Front plate
- 3 Pressure ring
- 4 Bayonet flange
- 5 Switching element

## Pushbutton

The actuator is inserted from the front through the mounting hole and locked at the rear by twisting the boyonet flange. The switch is fixed and positioned by evenly tightening the two screws in the mounting flange to a max. torque of 25 ... 30 Ncm. A reducing ring can be used to fit 22.5 mm into a 30.5 mm hole.



The switching elements (max. 3) or transformers, E-stop (max. 2), can easily be snapped in position without tools. LED's or filament lamps, as well as marking plates can be inserted or fitted from the front.



We can supply switching elements with terminal labels inserted.



To dismantle the switching elements or transformers one arm of the snap-on system is eased up with a screwdriver so that the snapped-on parts can easily be removed.



## Rotary selector switch

### Actuator

#### Step 1

Mounting of the actuator element:

1. Insert actuator from the front into the mounting hole.
2. Push mounting flange onto the actuator from the back and latch with bayonet.
3. Screw flange on with the two threaded pins.
4. Put lever into reference position (nine o'clock).



### Rotary switch element

#### Step 2

Snap rotary switch onto the actuator:

1. First check switch number with circuit diagram.
2. Put switching position of the cam at nine o'clock.
3. Snap rotary switch element onto the mounting flange, pay attention to position of the driver.
4. Check to see that the two snap-action legs have engaged.
5. Check the switching action in accordance with the switching sequence.



## Indicator full-face illumination compact



### Essential Accessories:

Single-LED page 58

|  | Front protection | Terminals |                                | Ø 29 mm<br>Typ-Nr. | Mounting dimensions | Technical drawing | Circuit drawing |       |
|--|------------------|-----------|--------------------------------|--------------------|---------------------|-------------------|-----------------|-------|
| <b>Indicator full-face illumination compact</b><br>Filament lamp 130 V, max. 2.6 W with integrated series resistor<br>230/130 V<br>Marking cap white translucent | IP 65            | ST        | Lens cap                       |                    |                     |                   |                 |       |
|  |                  |           | Plastic blue translucent       | <b>704.022.6</b>   | 3                   | 2                 | 51              | 0.025 |
|  |                  |           | Plastic colourless translucent | <b>704.022.7</b>   | 3                   | 2                 | 51              | 0.025 |
|  |                  |           | Plastic green translucent      | <b>704.022.5</b>   | 3                   | 2                 | 51              | 0.025 |
|  |                  |           | Plastic red translucent        | <b>704.022.2</b>   | 3                   | 2                 | 51              | 0.025 |
|  |                  |           | Plastic yellow translucent     | <b>704.022.4</b>   | 3                   | 2                 | 51              | 0.025 |
| Filament lamp 60 V, max. 2.6 W with integrated series resistor<br>125/60 V<br>Marking cap white translucent  | IP 65            | ST        | Plastic blue translucent       | <b>704.024.6</b>   | 3                   | 2                 | 51              | 0.025 |
|  |                  |           | Plastic colourless translucent | <b>704.024.7</b>   | 3                   | 2                 | 51              | 0.025 |
|  |                  |           | Plastic green translucent      | <b>704.024.5</b>   | 3                   | 2                 | 51              | 0.025 |
|  |                  |           | Plastic red translucent        | <b>704.024.2</b>   | 3                   | 2                 | 51              | 0.025 |
|  |                  |           | Plastic yellow translucent     | <b>704.024.4</b>   | 3                   | 2                 | 51              | 0.025 |
| Filament lamp max. 2.6 W or LED<br>Marking cap white translucent   | IP 65            | ST        | Plastic blue translucent       | <b>704.020.6</b>   | 3                   | 2                 | 5               | 0.020 |
|  |                  |           | Plastic colourless translucent | <b>704.020.7</b>   | 3                   | 2                 | 5               | 0.020 |
|  |                  |           | Plastic green translucent      | <b>704.020.5</b>   | 3                   | 2                 | 5               | 0.020 |
|  |                  |           | Plastic red translucent        | <b>704.020.2</b>   | 3                   | 2                 | 5               | 0.020 |
|  |                  |           | Plastic yellow translucent     | <b>704.020.4</b>   | 3                   | 2                 | 5               | 0.020 |
| Marking plate colourless transparent ribbed  | IP 65            | ST        | Plastic blue transparent       | <b>704.021.6</b>   | 3                   | 2                 | 5               | 0.020 |
|  |                  |           | Plastic colourless transparent | <b>704.021.7</b>   | 3                   | 2                 | 5               | 0.020 |
|  |                  |           | Plastic green transparent      | <b>704.021.5</b>   | 3                   | 2                 | 5               | 0.020 |
|  |                  |           | Plastic red transparent        | <b>704.021.2</b>   | 3                   | 2                 | 5               | 0.020 |
|  |                  |           | Plastic yellow transparent     | <b>704.021.4</b>   | 3                   | 2                 | 5               | 0.020 |

Terminals: ST = Screw terminal

Mounting dimensions from page 91, Technical drawing from page 95, Circuit drawing from page 115

## Indicator full face illumination



### Essential Accessories:

 Single-LED page 58

|  | Front protection | Terminals        | Frontbezel/-ring                          | Lens cap           | ∅ 30 x 30 mm<br>Typ-Nr. | ∅ 29 mm<br>Typ-Nr. | Mounting dimensions | Technical drawing | Circuit drawing  |  |
|--|------------------|------------------|---|--------------------|-------------------------|--------------------|---------------------|-------------------|------------------|---|
| <b>Indicator full face illumination</b><br>Filament lamp or LED<br>Marking plate white translucent | IP 65            | ST               | Plastic black                             | Plastic blue       | <b>704.199.6</b>        |                    | 5                   | 3                 | 5                | 0.050   |
|  |                  |                  |   | Plastic colourless | <b>704.199.7</b>        |                    | 5                   | 3                 | 5                | 0.050   |
|  |                  |                  |   | Plastic green      | <b>704.199.5</b>        |                    | 5                   | 3                 | 5                | 0.050   |
|  |                  |                  |   | Plastic red        | <b>704.199.2</b>        |                    | 5                   | 3                 | 5                | 0.050   |
|  |                  |                  |   | Plastic yellow     | <b>704.199.4</b>        |                    | 5                   | 3                 | 5                | 0.050   |
|  |                  |                  | Plastic grey                              | Plastic blue       | <b>704.200.6</b>        |                    | 5                   | 3                 | 5                | 0.050   |
|  |                  |                  |   | Plastic colourless | <b>704.200.7</b>        |                    | 5                   | 3                 | 5                | 0.050   |
|  |                  |                  |   | Plastic green      | <b>704.200.5</b>        |                    | 5                   | 3                 | 5                | 0.050   |
|  |                  |                  |   | Plastic red        | <b>704.200.2</b>        |                    | 5                   | 3                 | 5                | 0.050   |
|  |                  |                  | without                                   | Plastic yellow     | <b>704.200.4</b>        |                    | 5                   | 3                 | 5                | 0.050   |
|  |                  |                  |   | Plastic blue       |                         | <b>704.000.6</b>   | 5                   | 3                 | 5                | 0.050   |
|  |                  |                  |   | Plastic colourless |                         | <b>704.000.7</b>   | 5                   | 3                 | 5                | 0.050   |
|  |                  |                  |   | Plastic green      |                         | <b>704.000.5</b>   | 5                   | 3                 | 5                | 0.050   |
|  |                  |                  |   | Plastic red        |                         | <b>704.000.2</b>   | 5                   | 3                 | 5                | 0.050   |
|  |                  |                  | Marking cap colourless transparent ripped | IP 65              | ST                      | without            | Plastic blue        |                   | <b>704.001.6</b> | 5   |
| Plastic colourless   |                  | <b>704.001.7</b> |   |                    |                         |                    | 5                   | 3                 | 5                | 0.050   |
| Plastic green  |                  | <b>704.001.5</b> |   |                    |                         |                    | 5                   | 3                 | 5                | 0.050   |
| Plastic red  |                  | <b>704.001.2</b> |   |                    |                         |                    | 5                   | 3                 | 5                | 0.050   |
| Plastic yellow   |                  | <b>704.001.4</b> |   |                    |                         |                    | 5                   | 3                 | 5                | 0.050   |

Terminals: ST = Screw terminal

Mounting dimensions from page 91, Technical drawing from page 95, Circuit drawing from page 115

## Indicator front illumination



### Essential Accessories:

🛒 Single-LED page 58

|  | Front protection | Terminals | Frontbezel/-ring | Lens               | ∅ 30 x 30 mm<br>Typ-Nr. | ∅ 29 mm<br>Typ-Nr. | Mounting dimensions | Technical drawing | Circuit drawing | (mm)  |
|--|------------------|-----------|------------------|--------------------|-------------------------|--------------------|---------------------|-------------------|-----------------|-------|
| <b>Indicator front illumination</b><br>Filament lamp or LED<br>Marking plate white translucent | IP 65            | ST        | Plastic black    | Plastic blue       | <b>704.206.6</b>        | <b>704.006.6</b>   | 5                   | 5                 | 5               | 0.050 |
|  |                  |           |                  | Plastic colourless | <b>704.206.7</b>        | <b>704.006.7</b>   | 5                   | 5                 | 5               | 0.050 |
|  |                  |           |                  | Plastic green      | <b>704.206.5</b>        | <b>704.006.5</b>   | 5                   | 5                 | 5               | 0.050 |
|  |                  |           |                  | Plastic red        | <b>704.206.2</b>        | <b>704.006.2</b>   | 5                   | 5                 | 5               | 0.050 |
|  |                  |           |                  | Plastic yellow     | <b>704.206.4</b>        | <b>704.006.4</b>   | 5                   | 5                 | 5               | 0.050 |
|  |                  |           | Plastic grey     | Plastic blue       | <b>704.202.6</b>        | <b>704.002.6</b>   | 5                   | 5                 | 5               | 0.050 |
|  |                  |           |                  | Plastic colourless | <b>704.202.7</b>        | <b>704.002.7</b>   | 5                   | 5                 | 5               | 0.050 |
|  |                  |           |                  | Plastic green      | <b>704.202.5</b>        | <b>704.002.5</b>   | 5                   | 5                 | 5               | 0.050 |
|  |                  |           |                  | Plastic red        | <b>704.202.2</b>        | <b>704.002.2</b>   | 5                   | 5                 | 5               | 0.050 |
|  |                  |           |                  | Plastic yellow     | <b>704.202.4</b>        | <b>704.002.4</b>   | 5                   | 5                 | 5               | 0.050 |
| Marking plate colourless transparent ribbed  | IP 65            | ST        | Plastic black    | Plastic blue       | <b>704.207.6</b>        | <b>704.007.6</b>   | 5                   | 5                 | 5               | 0.050 |
|  |                  |           |                  | Plastic colourless | <b>704.207.7</b>        | <b>704.007.7</b>   | 5                   | 5                 | 5               | 0.050 |
|  |                  |           |                  | Plastic green      | <b>704.207.5</b>        | <b>704.007.5</b>   | 5                   | 5                 | 5               | 0.050 |
|  |                  |           |                  | Plastic red        | <b>704.207.2</b>        | <b>704.007.2</b>   | 5                   | 5                 | 5               | 0.050 |
|  |                  |           |                  | Plastic yellow     | <b>704.207.4</b>        | <b>704.007.4</b>   | 5                   | 5                 | 5               | 0.050 |
|  |                  |           | Plastic grey     | Plastic blue       | <b>704.203.6</b>        | <b>704.003.6</b>   | 5                   | 5                 | 5               | 0.050 |
|  |                  |           |                  | Plastic colourless | <b>704.203.7</b>        | <b>704.003.7</b>   | 5                   | 5                 | 5               | 0.050 |
|  |                  |           |                  | Plastic green      | <b>704.203.5</b>        | <b>704.003.5</b>   | 5                   | 5                 | 5               | 0.050 |
|  |                  |           |                  | Plastic red        | <b>704.203.2</b>        | <b>704.003.2</b>   | 5                   | 5                 | 5               | 0.050 |
|  |                  |           |                  | Plastic yellow     | <b>704.203.4</b>        | <b>704.003.4</b>   | 5                   | 5                 | 5               | 0.050 |

Terminals: ST = Screw terminal

Mounting dimensions from page 91, Technical drawing from page 95, Circuit drawing from page 115



## Flasher full face illumination



### Essential Accessories:

- Flasher element page 50
- Single-LED page 58

|  | Front protection | Frontbezel/-ring | Lens cap           | Ø 30 x 30 mm<br>Typ-Nr. | Ø 29 mm<br>Typ-Nr. | Mounting dimensions | Technical drawing | Circuit drawing | kg    |
|--|------------------|------------------|--------------------|-------------------------|--------------------|---------------------|-------------------|-----------------|-------|
| <b>Flasher full face illumination</b><br>Filament lamp or LED<br>Marking plate white translucent | IP 65            | Plastic black    | Plastic blue       | <b>704.199.6</b>        |                    | 5                   | 6                 | 5               | 0.050 |
|  |                  |                  | Plastic colourless | <b>704.199.7</b>        |                    | 5                   | 6                 | 5               | 0.050 |
|  |                  |                  | Plastic green      | <b>704.199.5</b>        |                    | 5                   | 6                 | 5               | 0.050 |
|  |                  |                  | Plastic red        | <b>704.199.2</b>        |                    | 5                   | 6                 | 5               | 0.050 |
|  |                  |                  | Plastic yellow     | <b>704.199.4</b>        |                    | 5                   | 6                 | 5               | 0.050 |
|  |                  | Plastic grey     | Plastic blue       | <b>704.200.6</b>        |                    | 5                   | 6                 | 5               | 0.050 |
|  |                  |                  | Plastic colourless | <b>704.200.7</b>        |                    | 5                   | 6                 | 5               | 0.050 |
|  |                  |                  | Plastic green      | <b>704.200.5</b>        |                    | 5                   | 6                 | 5               | 0.050 |
|  |                  |                  | Plastic red        | <b>704.200.2</b>        |                    | 5                   | 6                 | 5               | 0.050 |
|  |                  |                  | Plastic yellow     | <b>704.200.4</b>        |                    | 5                   | 6                 | 5               | 0.050 |
|  |                  | without          | Plastic blue       |                         | <b>704.000.6</b>   | 5                   | 6                 | 5               | 0.050 |
|  |                  |                  | Plastic colourless |                         | <b>704.000.7</b>   | 5                   | 6                 | 5               | 0.050 |
|  |                  |                  | Plastic green      |                         | <b>704.000.5</b>   | 5                   | 6                 | 5               | 0.050 |
|  |                  |                  | Plastic red        |                         | <b>704.000.2</b>   | 5                   | 6                 | 5               | 0.050 |
|  |                  |                  | Plastic yellow     |                         | <b>704.000.4</b>   | 5                   | 6                 | 5               | 0.050 |
| Marking cap colourless transparent ripped  | IP 65            | without          | Plastic blue       |                         | <b>704.001.6</b>   | 5                   | 6                 | 5               | 0.050 |
|  |                  |                  | Plastic colourless |                         | <b>704.001.7</b>   | 5                   | 6                 | 5               | 0.050 |
|  |                  |                  | Plastic green      |                         | <b>704.001.5</b>   | 5                   | 6                 | 5               | 0.050 |
|  |                  |                  | Plastic red        |                         | <b>704.001.2</b>   | 5                   | 6                 | 5               | 0.050 |
|  |                  |                  | Plastic yellow     |                         | <b>704.001.4</b>   | 5                   | 6                 | 5               | 0.050 |

Mounting dimensions from page 91, Technical drawing from page 95, Circuit drawing from page 115

## Flasher front illumination



### Essential Accessories:

 Flasher element page 50

 Single-LED page 58

|  | Front protection | Frontbezel/-ring | Lens               | ∅ 30 x 30 mm<br>Typ-Nr. | ∅ 29 mm<br>Typ-Nr. | Mounting dimensions | Technical drawing | Circuit drawing |  |
|--|------------------|------------------|--------------------|-------------------------|--------------------|---------------------|-------------------|-----------------|---|
| <b>Flasher front illumination</b><br>Filament lamp or LED<br>Marking plate white translucent | IP 65            | Plastic black    | Plastic blue       | <b>704.206.6</b>        | <b>704.006.6</b>   | 5                   | 7                 | 5               | 0.050   |
|  |                  |                  | Plastic colourless | <b>704.206.7</b>        | <b>704.006.7</b>   | 5                   | 7                 | 5               | 0.050   |
|  |                  |                  | Plastic green      | <b>704.206.5</b>        | <b>704.006.5</b>   | 5                   | 7                 | 5               | 0.050   |
|  |                  |                  | Plastic red        | <b>704.206.2</b>        | <b>704.006.2</b>   | 5                   | 7                 | 5               | 0.050   |
|  |                  |                  | Plastic yellow     | <b>704.206.4</b>        | <b>704.006.4</b>   | 5                   | 7                 | 5               | 0.050   |
|  |                  | Plastic grey     | Plastic blue       | <b>704.202.6</b>        | <b>704.002.6</b>   | 5                   | 7                 | 5               | 0.050   |
|  |                  |                  | Plastic colourless | <b>704.202.7</b>        | <b>704.002.7</b>   | 5                   | 7                 | 5               | 0.050   |
|  |                  |                  | Plastic green      | <b>704.202.5</b>        | <b>704.002.5</b>   | 5                   | 7                 | 5               | 0.050   |
|  |                  |                  | Plastic red        | <b>704.202.2</b>        | <b>704.002.2</b>   | 5                   | 7                 | 5               | 0.050   |
|  |                  |                  | Plastic yellow     | <b>704.202.4</b>        | <b>704.002.4</b>   | 5                   | 7                 | 5               | 0.050   |
| Marking plate colourless transparent ribbed  | IP 65            | Plastic black    | Plastic blue       | <b>704.207.6</b>        | <b>704.007.6</b>   | 5                   | 7                 | 5               | 0.050   |
|  |                  |                  | Plastic colourless | <b>704.207.7</b>        | <b>704.007.7</b>   | 5                   | 7                 | 5               | 0.050   |
|  |                  |                  | Plastic green      | <b>704.207.5</b>        | <b>704.007.5</b>   | 5                   | 7                 | 5               | 0.050   |
|  |                  |                  | Plastic red        | <b>704.207.2</b>        | <b>704.007.2</b>   | 5                   | 7                 | 5               | 0.050   |
|  |                  |                  | Plastic yellow     | <b>704.207.4</b>        | <b>704.007.4</b>   | 5                   | 7                 | 5               | 0.050   |
|  |                  | Plastic grey     | Plastic blue       | <b>704.203.6</b>        | <b>704.003.6</b>   | 5                   | 7                 | 5               | 0.050   |
|  |                  |                  | Plastic colourless | <b>704.203.7</b>        | <b>704.003.7</b>   | 5                   | 7                 | 5               | 0.050   |
|  |                  |                  | Plastic green      | <b>704.203.5</b>        | <b>704.003.5</b>   | 5                   | 7                 | 5               | 0.050   |
|  |                  |                  | Plastic red        | <b>704.203.2</b>        | <b>704.003.2</b>   | 5                   | 7                 | 5               | 0.050   |
|  |                  |                  | Plastic yellow     | <b>704.203.4</b>        | <b>704.003.4</b>   | 5                   | 7                 | 5               | 0.050   |

Mounting dimensions from page 91, Technical drawing from page 95, Circuit drawing from page 115

## Buzzer



|   | Front protection | Front cap           | Terminals | Ø 29 mm<br>Typ-Nr. | Mounting dimensions | Technical drawing | Circuit drawing |       |
|---|------------------|---------------------|-----------|--------------------|---------------------|-------------------|-----------------|-------|
| <b>Buzzer</b><br>Operation voltage 24 VDC | IP 65            | Brass nickel-plated | S1        | <b>14-810.902</b>  | 5                   | 18                | 1               | 0.016 |
|   |                  | Plastic black       | S1        | <b>14-810.002</b>  | 5                   | 18                | 1               | 0.016 |

Further information in the Technical Data and Typical Applications

Terminals: S1 = Soldering terminal (also pluggable 2.8 x 0.5 mm)

Mounting dimensions from page 91, Technical drawing from page 95, Circuit drawing from page 115

## Pushbutton actuator



### Essential Accessories:

 Switching element page 51

|                            | Front protection | Switching action | Frontbezel/-ring  | Lens                  | □ 30 x 30 mm<br>Typ-Nr. | ∅ 29 mm<br>Typ-Nr. | Mounting dimensions | Technical drawing | Circuit drawing |  |       |
|----------------------------|------------------|------------------|-------------------|-----------------------|-------------------------|--------------------|---------------------|-------------------|-----------------|---|-------|
| <b>Pushbutton actuator</b> | IP 65            | MA               | Plastic black     | Plastic black         | <b>704.239.0</b>        | <b>704.039.0</b>   | 5                   | 4                 | 3               | 0.040   |       |
|                            |                  |                  |                   | Plastic blue          | <b>704.239.6</b>        | <b>704.039.6</b>   | 5                   | 4                 | 3               | 0.040   |       |
|                            |                  |                  |                   | Plastic colourless    | <b>704.239.7</b>        | <b>704.039.7</b>   | 5                   | 4                 | 3               | 0.040   |       |
|                            |                  |                  |                   | Plastic green         | <b>704.239.5</b>        | <b>704.039.5</b>   | 5                   | 4                 | 3               | 0.040   |       |
|                            |                  |                  |                   | Plastic red           | <b>704.239.2</b>        | <b>704.039.2</b>   | 5                   | 4                 | 3               | 0.040   |       |
|                            |                  |                  |                   | Plastic yellow        | <b>704.239.4</b>        | <b>704.039.4</b>   | 5                   | 4                 | 3               | 0.040   |       |
|                            |                  |                  | Plastic grey      | Plastic black         | <b>704.240.0</b>        | <b>704.040.0</b>   | 5                   | 4                 | 3               | 0.040   |       |
|                            |                  |                  |                   | Plastic blue          | <b>704.240.6</b>        | <b>704.040.6</b>   | 5                   | 4                 | 3               | 0.040   |       |
|                            |                  |                  |                   | Plastic colourless    | <b>704.240.7</b>        | <b>704.040.7</b>   | 5                   | 4                 | 3               | 0.040   |       |
|                            |                  |                  |                   | Plastic green         | <b>704.240.5</b>        | <b>704.040.5</b>   | 5                   | 4                 | 3               | 0.040   |       |
|                            |                  |                  |                   | Plastic red           | <b>704.240.2</b>        | <b>704.040.2</b>   | 5                   | 4                 | 3               | 0.040   |       |
|                            |                  |                  |                   | Plastic yellow        | <b>704.240.4</b>        | <b>704.040.4</b>   | 5                   | 4                 | 3               | 0.040   |       |
|                            |                  |                  | M                 | Plastic black         | Plastic black           | <b>704.209.0</b>   | <b>704.009.0</b>    | 5                 | 4               | 4   | 0.040 |
|                            |                  |                  |                   |                       | Plastic blue            | <b>704.209.6</b>   | <b>704.009.6</b>    | 5                 | 4               | 4   | 0.040 |
|                            |                  |                  |                   |                       | Plastic colourless      | <b>704.209.7</b>   | <b>704.009.7</b>    | 5                 | 4               | 4   | 0.040 |
|                            |                  |                  |                   |                       | Plastic green           | <b>704.209.5</b>   | <b>704.009.5</b>    | 5                 | 4               | 4   | 0.040 |
|                            |                  |                  |                   |                       | Plastic red             | <b>704.209.2</b>   | <b>704.009.2</b>    | 5                 | 4               | 4   | 0.040 |
|                            |                  |                  |                   |                       | Plastic yellow          | <b>704.209.4</b>   | <b>704.009.4</b>    | 5                 | 4               | 4   | 0.040 |
|                            |                  | Plastic grey     |                   | Plastic black         | <b>704.210.0</b>        | <b>704.010.0</b>   | 5                   | 4                 | 4               | 0.040   |       |
|                            |                  |                  |                   | Plastic blue          | <b>704.210.6</b>        | <b>704.010.6</b>   | 5                   | 4                 | 4               | 0.040   |       |
|                            |                  |                  |                   | Plastic colourless    | <b>704.210.7</b>        | <b>704.010.7</b>   | 5                   | 4                 | 4               | 0.040   |       |
|                            |                  |                  |                   | Plastic green         | <b>704.210.5</b>        | <b>704.010.5</b>   | 5                   | 4                 | 4               | 0.040   |       |
|                            |                  |                  |                   | Plastic red           | <b>704.210.2</b>        | <b>704.010.2</b>   | 5                   | 4                 | 4               | 0.040   |       |
|                            |                  |                  |                   | Plastic yellow        | <b>704.210.4</b>        | <b>704.010.4</b>   | 5                   | 4                 | 4               | 0.040   |       |
|                            |                  | MA               | Aluminium natural | Aluminium black       |                         | <b>704.041.0</b>   | 5                   | 4                 | 3               | 0.040   |       |
|                            |                  |                  |                   | Aluminium blue        |                         | <b>704.041.6</b>   | 5                   | 4                 | 3               | 0.040   |       |
|                            |                  |                  |                   | Aluminium gold        |                         | <b>704.041.4</b>   | 5                   | 4                 | 3               | 0.040   |       |
|                            |                  |                  |                   | Aluminium natural     |                         | <b>704.041.8</b>   | 5                   | 4                 | 3               | 0.040   |       |
|                            |                  |                  |                   | Aluminium olive-green |                         | <b>704.041.5</b>   | 5                   | 4                 | 3               | 0.040   |       |
|                            |                  |                  |                   | Aluminium red         |                         | <b>704.041.2</b>   | 5                   | 4                 | 3               | 0.040   |       |
|                            |                  |                  |                   | Plastic black         |                         | <b>704.042.0</b>   | 5                   | 4                 | 3               | 0.040   |       |
|                            |                  |                  |                   | Plastic blue          |                         | <b>704.042.6</b>   | 5                   | 4                 | 3               | 0.040   |       |
|                            |                  |                  |                   | Plastic colourless    |                         | <b>704.042.7</b>   | 5                   | 4                 | 3               | 0.040   |       |
|                            |                  |                  |                   | Plastic green         |                         | <b>704.042.5</b>   | 5                   | 4                 | 3               | 0.040   |       |
|                            |                  |                  |                   | Plastic red           |                         | <b>704.042.2</b>   | 5                   | 4                 | 3               | 0.040   |       |
|                            |                  |                  |                   | Plastic yellow        |                         | <b>704.042.4</b>   | 5                   | 4                 | 3               | 0.040   |       |

Continuation see next page

Continued from previous page

|                            | Front protection   | Switching action                      | Frontbezel/-ring   | Lens                  | ⌀ 30 x 30 mm<br>Typ-Nr. | Ø 29 mm<br>Typ-Nr.                    | Mounting dimensions | Technical drawing | Circuit drawing  |  |   |       |  |
|----------------------------|--------------------|---------------------------------------|--------------------|-----------------------|-------------------------|---------------------------------------|---------------------|-------------------|------------------|---|---|-------|--|
| <b>Pushbutton actuator</b> | IP 65              | M                                     | Aluminium natural  | Aluminium black       |                         | <b>704.011.0</b>                      | 5 4 4               | 4                 | 0.040            |   |   |       |  |
|                            |                    |                                       |                    | Aluminium blue        |                         | <b>704.011.6</b>                      | 5 4 4               | 4                 | 0.040            |   |   |       |  |
|                            |                    |                                       |                    | Aluminium gold        |                         | <b>704.011.4</b>                      | 5 4 4               | 4                 | 0.040            |   |   |       |  |
|                            |                    |                                       |                    | Aluminium natural     |                         | <b>704.011.8</b>                      | 5 4 4               | 4                 | 0.040            |   |   |       |  |
|                            |                    |                                       |                    | Aluminium olive-green |                         | <b>704.011.5</b>                      | 5 4 4               | 4                 | 0.040            |   |   |       |  |
|                            |                    |                                       |                    | Aluminium red         |                         | <b>704.011.2</b>                      | 5 4 4               | 4                 | 0.040            |   |   |       |  |
|                            |                    |                                       |                    | Plastic black         |                         | <b>704.012.0</b>                      | 5 4 4               | 4                 | 0.040            |   |   |       |  |
|                            |                    |                                       |                    | Plastic blue          |                         | <b>704.012.6</b>                      | 5 4 4               | 4                 | 0.040            |   |   |       |  |
|                            |                    |                                       |                    | Plastic colourless    |                         | <b>704.012.7</b>                      | 5 4 4               | 4                 | 0.040            |   |   |       |  |
|                            |                    |                                       |                    | Plastic green         |                         | <b>704.012.5</b>                      | 5 4 4               | 4                 | 0.040            |   |   |       |  |
|                            |                    |                                       |                    | Plastic red           |                         | <b>704.012.2</b>                      | 5 4 4               | 4                 | 0.040            |   |   |       |  |
|                            |                    |                                       |                    | Plastic yellow        |                         | <b>704.012.4</b>                      | 5 4 4               | 4                 | 0.040            |   |   |       |  |
|                            |                    |                                       |                    | IP 67                 | MA                      | Aluminium natural with protective cap | Plastic black       |                   | <b>704.043.0</b> | 5 4 3   | 3 | 0.040 |  |
|                            |                    |                                       |                    |                       |                         |                                       | Plastic blue        |                   | <b>704.043.6</b> | 5 4 3   | 3 | 0.040 |  |
|                            | Plastic colourless |                                       | <b>704.043.7</b>   |                       |                         |                                       | 5 4 3               | 3                 | 0.040            |   |   |       |  |
|                            | Plastic green      |                                       | <b>704.043.5</b>   |                       |                         |                                       | 5 4 3               | 3                 | 0.040            |   |   |       |  |
|                            | Plastic red        |                                       | <b>704.043.2</b>   |                       |                         |                                       | 5 4 3               | 3                 | 0.040            |   |   |       |  |
|                            | Plastic yellow     |                                       | <b>704.043.4</b>   |                       | 5 4 3                   |                                       | 3                   | 0.040             |                  |   |   |       |  |
|                            | M                  | Aluminium natural with protective cap | Plastic black      |                       |                         |                                       | <b>704.013.0</b>    | 5 4 4             | 4                | 0.040   |   |       |  |
|                            |                    |                                       | Plastic blue       |                       |                         |                                       | <b>704.013.6</b>    | 5 4 4             | 4                | 0.040   |   |       |  |
|                            |                    |                                       | Plastic colourless |                       |                         |                                       | <b>704.013.7</b>    | 5 4 4             | 4                | 0.040   |   |       |  |
|                            |                    |                                       | Plastic green      |                       |                         |                                       | <b>704.013.5</b>    | 5 4 4             | 4                | 0.040   |   |       |  |
|                            |                    |                                       | Plastic red        |                       | <b>704.013.2</b>        | 5 4 4                                 | 4                   | 0.040             |                  |   |   |       |  |
|                            | Plastic yellow     |                                       | <b>704.013.4</b>   | 5 4 4                 | 4                       | 0.040                                 |                     |                   |                  |   |   |       |  |

Fronting with protective cover to be mounted with a torque of 40 Ncm onto actuator.

Switching action: MA = Maintained action, M = Momentary action

Mounting dimensions from page 91, Technical drawing from page 95, Circuit drawing from page 115

## Illuminated pushbutton actuator



### Essential Accessories:

- Single-LED page 58
- Switching element page 51

|  | Front protection | Switching action                      | Frontbezel/-ring                      | Lens               | ∅ 30 x 30 mm<br>Typ-Nr. | ∅ 29 mm<br>Typ-Nr. | Mounting dimensions | Technical drawing | Circuit drawing |       |
|--|------------------|---------------------------------------|---------------------------------------|--------------------|-------------------------|--------------------|---------------------|-------------------|-----------------|-------|
| <b>Illuminated pushbutton actuator</b> | IP 65            | MA                                    | Plastic black                         | Plastic blue       | <b>704.259.6</b>        | <b>704.059.6</b>   | 5                   | 8                 | 34              | 0.056 |
|  |                  |                                       |                                       | Plastic colourless | <b>704.259.7</b>        | <b>704.059.7</b>   | 5                   | 8                 | 34              | 0.056 |
|  |                  |                                       |                                       | Plastic green      | <b>704.259.5</b>        | <b>704.059.5</b>   | 5                   | 8                 | 34              | 0.056 |
|  |                  |                                       |                                       | Plastic red        | <b>704.259.2</b>        | <b>704.059.2</b>   | 5                   | 8                 | 34              | 0.056 |
|  |                  |                                       |                                       | Plastic yellow     | <b>704.259.4</b>        | <b>704.059.4</b>   | 5                   | 8                 | 34              | 0.056 |
|  |                  |                                       | Plastic grey                          | Plastic blue       | <b>704.260.6</b>        | <b>704.060.6</b>   | 5                   | 8                 | 34              | 0.056 |
|  |                  |                                       |                                       | Plastic colourless | <b>704.260.7</b>        | <b>704.060.7</b>   | 5                   | 8                 | 34              | 0.056 |
|  |                  |                                       |                                       | Plastic green      | <b>704.260.5</b>        | <b>704.060.5</b>   | 5                   | 8                 | 34              | 0.056 |
|  |                  |                                       |                                       | Plastic red        | <b>704.260.2</b>        | <b>704.060.2</b>   | 5                   | 8                 | 34              | 0.056 |
|  |                  |                                       |                                       | Plastic yellow     | <b>704.260.4</b>        | <b>704.060.4</b>   | 5                   | 8                 | 34              | 0.056 |
|  |                  | M                                     | Plastic black                         | Plastic blue       | <b>704.229.6</b>        | <b>704.029.6</b>   | 5                   | 8                 | 41              | 0.056 |
|  |                  |                                       |                                       | Plastic colourless | <b>704.229.7</b>        | <b>704.029.7</b>   | 5                   | 8                 | 41              | 0.056 |
|  |                  |                                       |                                       | Plastic green      | <b>704.229.5</b>        | <b>704.029.5</b>   | 5                   | 8                 | 41              | 0.056 |
|  |                  |                                       |                                       | Plastic red        | <b>704.229.2</b>        | <b>704.029.2</b>   | 5                   | 8                 | 41              | 0.056 |
|  |                  |                                       |                                       | Plastic yellow     | <b>704.229.4</b>        | <b>704.029.4</b>   | 5                   | 8                 | 41              | 0.056 |
|  |                  |                                       | Plastic grey                          | Plastic blue       | <b>704.230.6</b>        | <b>704.030.6</b>   | 5                   | 8                 | 41              | 0.056 |
|  |                  |                                       |                                       | Plastic colourless | <b>704.230.7</b>        | <b>704.030.7</b>   | 5                   | 8                 | 41              | 0.056 |
|  |                  |                                       |                                       | Plastic green      | <b>704.230.5</b>        | <b>704.030.5</b>   | 5                   | 8                 | 41              | 0.056 |
|  |                  |                                       |                                       | Plastic red        | <b>704.230.2</b>        | <b>704.030.2</b>   | 5                   | 8                 | 41              | 0.056 |
|  |                  |                                       |                                       | Plastic yellow     | <b>704.230.4</b>        | <b>704.030.4</b>   | 5                   | 8                 | 41              | 0.056 |
|  | MA               | Aluminium natural                     | Plastic blue                          |                    | <b>704.062.6</b>        | 5                  | 8                   | 34                | 0.056           |       |
|  |                  |                                       | Plastic colourless                    |                    | <b>704.062.7</b>        | 5                  | 8                   | 34                | 0.056           |       |
|  |                  |                                       | Plastic green                         |                    | <b>704.062.5</b>        | 5                  | 8                   | 34                | 0.056           |       |
|  |                  |                                       | Plastic red                           |                    | <b>704.062.2</b>        | 5                  | 8                   | 34                | 0.056           |       |
|  |                  |                                       | Plastic yellow                        |                    | <b>704.062.4</b>        | 5                  | 8                   | 34                | 0.056           |       |
|  | M                | Aluminium natural                     | Plastic blue                          |                    | <b>704.032.6</b>        | 5                  | 8                   | 41                | 0.056           |       |
|  |                  |                                       | Plastic colourless                    |                    | <b>704.032.7</b>        | 5                  | 8                   | 41                | 0.056           |       |
|  |                  |                                       | Plastic green                         |                    | <b>704.032.5</b>        | 5                  | 8                   | 41                | 0.056           |       |
|  |                  |                                       | Plastic red                           |                    | <b>704.032.2</b>        | 5                  | 8                   | 41                | 0.056           |       |
|  |                  |                                       | Plastic yellow                        |                    | <b>704.032.4</b>        | 5                  | 8                   | 41                | 0.056           |       |
|  |                  | Aluminium natural with protective cap | Plastic blue                          |                    | <b>704.033.6</b>        | 5                  | 8                   | 41                | 0.056           |       |
|  |                  |                                       | Plastic colourless                    |                    | <b>704.033.7</b>        | 5                  | 8                   | 41                | 0.056           |       |
|  |                  |                                       | Plastic green                         |                    | <b>704.033.5</b>        | 5                  | 8                   | 41                | 0.056           |       |
|  |                  |                                       | Plastic red                           |                    | <b>704.033.2</b>        | 5                  | 8                   | 41                | 0.056           |       |
|  |                  |                                       | Plastic yellow                        |                    | <b>704.033.4</b>        | 5                  | 8                   | 41                | 0.056           |       |
|  | IP 67            | MA                                    | Aluminium natural with protective cap | Plastic blue       |                         | <b>704.063.6</b>   | 5                   | 8                 | 34              | 0.056 |
|  |                  |                                       |                                       | Plastic colourless |                         | <b>704.063.7</b>   | 5                   | 8                 | 34              | 0.056 |
|  |                  |                                       |                                       | Plastic green      |                         | <b>704.063.5</b>   | 5                   | 8                 | 34              | 0.056 |
|  |                  |                                       |                                       | Plastic red        |                         | <b>704.063.2</b>   | 5                   | 8                 | 34              | 0.056 |
|  |                  |                                       |                                       | Plastic yellow     |                         | <b>704.063.4</b>   | 5                   | 8                 | 34              | 0.056 |

Continuation see next page

Continued from previous page

Frontring with protective cover to be mounted with a torque of 40 Ncm onto actuator.

Switching action: MA = Maintained action, M = Momentary action

Mounting dimensions from page 91, Technical drawing from page 95, Circuit drawing from page 115

## Emergency-stop pushbutton actuator, foolproof EN IEC 60947-5-5

Application as per DIN EN ISO 13850 and EN 60204-1



### Essential Accessories:

 Switching element for Emergency-stop pushbutton page 54

|   | Front protection | Switching action | Mushroom had cap | Marking | Ø 37 mm<br>Typ-Nr. | Mounting dimensions | Technical drawing | Circuit drawing |  |
|---|------------------|------------------|------------------|---------|--------------------|---------------------|-------------------|-----------------|---|
| <b>Emergency-stop pushbutton actuator, foolproof EN IEC 60947-5-5</b><br>Yellow actuator<br>Key to unlock anti-clockwise<br>Standard lock 9500<br>Max. 2 Slow-make elements can be clipped on | IP 65            | MA               | Plastic red      | Arrows  | <b>704.066.2</b>   | 2                   | 24                | 6               | 0.300   |
| Yellow actuator<br>Twist to unlock anti-clockwise<br>Max. 2 Slow-make elements can be clipped on  | IP 65            | MA               | Plastic red      | Arrows  | <b>704.064.2</b>   | 2                   | 14                | 6               | 0.300   |

Switching action: MA = Maintained action

Mounting dimensions from page 91, Technical drawing from page 95, Circuit drawing from page 115

## Stop pushbutton actuator



### Essential Accessories:

 Switching element for Emergency-stop pushbutton page 54

|   | Front protection | Switching action | Front ring        | Mushroom had cap | Marking | Ø 40 mm<br>Typ-Nr. | Mounting dimensions | Technical drawing | Circuit drawing |  |
|---|------------------|------------------|-------------------|------------------|---------|--------------------|---------------------|-------------------|-----------------|---|
| <b>Stop pushbutton actuator</b><br>Key to unlock clockwise<br>Standard lock 251 | IP 65            | MA               | Aluminium natural | Plastic red      | without | <b>704.078.0</b>   | 9                   | 17                | 6               | 0.063   |
|   |                  |                  | Plastic grey      | Plastic red      | without | <b>704.076.0</b>   | 9                   | 17                | 6               | 0.063   |
| Twist to unlock clockwise   | IP 65            | MA               | Aluminium natural | Plastic red      | Arrows  | <b>704.075.2</b>   | 9                   | 12                | 6               | 0.047   |
|   |                  |                  |                   |                  | Stop    | <b>704.075.3</b>   | 9                   | 12                | 6               | 0.047   |
|   |                  |                  | Plastic grey      | Plastic red      | Arrows  | <b>704.074.2</b>   | 9                   | 12                | 6               | 0.047   |
|   |                  |                  |                   |                  | Stop    | <b>704.074.3</b>   | 9                   | 12                | 6               | 0.047   |

Switching action: MA = Maintained action

Mounting dimensions from page 91, Technical drawing from page 95, Circuit drawing from page 115



## Mushroom-head pushbutton actuator



### Essential Accessories:

 Switching element page 51

|  | Front protection | Switching action | Front ring        | Mushroom had cap | Ø 40 mm<br>Typ-Nr. | Mounting dimensions | Technical drawing | Circuit drawing |  |
|--|------------------|------------------|-------------------|------------------|--------------------|---------------------|-------------------|-----------------|---|
| <b>Mushroom-head pushbutton actuator</b> | IP 65            | MA               | Aluminium natural | Plastic black    | <b>704.073.0</b>   | 9                   | 15                | 3               | 0.044   |
|  |                  |                  |                   | Plastic green    | <b>704.073.5</b>   | 9                   | 15                | 3               | 0.044   |
|  |                  |                  |                   | Plastic red      | <b>704.073.2</b>   | 9                   | 15                | 3               | 0.044   |
|  |                  |                  |                   | Plastic yellow   | <b>704.073.4</b>   | 9                   | 15                | 3               | 0.044   |
|  |                  |                  | Plastic grey      | Plastic black    | <b>704.072.0</b>   | 9                   | 15                | 3               | 0.044   |
|  |                  |                  |                   | Plastic green    | <b>704.072.5</b>   | 9                   | 15                | 3               | 0.044   |
|  |                  |                  |                   | Plastic red      | <b>704.072.2</b>   | 9                   | 15                | 3               | 0.044   |
|  |                  |                  |                   | Plastic yellow   | <b>704.072.4</b>   | 9                   | 15                | 3               | 0.044   |
|  |                  | M                | Aluminium natural | Plastic black    | <b>704.071.0</b>   | 9                   | 15                | 4               | 0.044   |
|  |                  |                  |                   | Plastic green    | <b>704.071.5</b>   | 9                   | 15                | 4               | 0.044   |
|  |                  |                  |                   | Plastic red      | <b>704.071.2</b>   | 9                   | 15                | 4               | 0.044   |
|  |                  |                  |                   | Plastic yellow   | <b>704.071.4</b>   | 9                   | 15                | 4               | 0.044   |
|  |                  |                  | Plastic grey      | Plastic black    | <b>704.070.0</b>   | 9                   | 15                | 4               | 0.044   |
|  |                  |                  |                   | Plastic green    | <b>704.070.5</b>   | 9                   | 15                | 4               | 0.044   |
|  |                  |                  |                   | Plastic red      | <b>704.070.2</b>   | 9                   | 15                | 4               | 0.044   |
|  |                  |                  |                   | Plastic yellow   | <b>704.070.4</b>   | 9                   | 15                | 4               | 0.044   |

Switching action: MA = Maintained action, M = Momentary action

Mounting dimensions from page 91, Technical drawing from page 95, Circuit drawing from page 115

## Mushroom-head pushbutton actuator illuminated



### Essential Accessories:

-  Single-LED page 58
-  Switching element page 51

|  | Front protection | Switching action | Front ring   | Mushroom had cap   | Ø 40 mm<br>Typ-Nr. | Mounting dimensions | Technical drawing | Circuit drawing |  |
|--|------------------|------------------|--------------|--------------------|--------------------|---------------------|-------------------|-----------------|---|
| <b>Mushroom-head pushbutton actuator illuminated</b> | IP 65            | MA               | Plastic grey | Plastic blue       | <b>704.086.6</b>   | 9                   | 13                | 34              | 0.044   |
|  |                  |                  |              | Plastic colourless | <b>704.086.7</b>   | 9                   | 13                | 34              | 0.044   |
|  |                  |                  |              | Plastic green      | <b>704.086.5</b>   | 9                   | 13                | 34              | 0.044   |
|  |                  |                  |              | Plastic red        | <b>704.086.2</b>   | 9                   | 13                | 34              | 0.044   |
|  |                  |                  |              | Plastic yellow     | <b>704.086.4</b>   | 9                   | 13                | 34              | 0.044   |
|  |                  | M                | Plastic grey | Plastic blue       | <b>704.084.6</b>   | 9                   | 13                | 41              | 0.044   |
|  |                  |                  |              | Plastic colourless | <b>704.084.7</b>   | 9                   | 13                | 41              | 0.044   |
|  |                  |                  |              | Plastic green      | <b>704.084.5</b>   | 9                   | 13                | 41              | 0.044   |
|  |                  |                  |              | Plastic red        | <b>704.084.2</b>   | 9                   | 13                | 41              | 0.044   |
|  |                  |                  |              | Plastic yellow     | <b>704.084.4</b>   | 9                   | 13                | 41              | 0.044   |

Switching action: MA = Maintained action, M = Momentary action

Mounting dimensions from page 91, Technical drawing from page 95, Circuit drawing from page 115

## Keylock switch actuator 2 positions



### Essential Accessories:

Switching element page 51

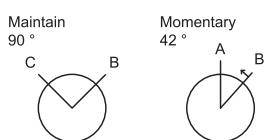

|   | Front protection | Switching action | Frontbezel/-ring          | Key remove | □ 30 x 30 mm<br>Typ-Nr. | ∅ 29 mm<br>Typ-Nr. | Mounting dimensions | Technical drawing | Circuit drawing |  |
|---|------------------|------------------|---------------------------|------------|-------------------------|--------------------|---------------------|-------------------|-----------------|--|
| <b>Keylock switch actuator 2 positions</b><br>Position A : Basic position<br>Position B : Momentary action 42°<br>Standard lock 251 | IP 65            | M                | Plastic grey              | A          | <b>704.343.0</b>        |                    | 5 9                 | 44                | 0.070           |  |
| Position C + B : Maintained action 90°<br>Standard lock 251   | IP 65            | MA               | Plastic grey              | B          | <b>704.340.0</b>        |                    | 5 9                 | 45                | 0.070           |  |
|   |                  |                  |                           | C          | <b>704.341.0</b>        |                    | 5 9                 | 45                | 0.070           |  |
|   |                  |                  |                           | C + B      | <b>704.342.0</b>        |                    | 5 9                 | 45                | 0.070           |  |
| Position A : Basic position<br>Position B : Momentary action 42°<br>Standard lock 251   | IP 65            | M                | Aluminium chromium-plated | A          |                         | <b>704.123.0</b>   | 5 9                 | 44                | 0.070           |  |
| Position C + B : Maintained action 90°<br>Standard lock 251   | IP 65            | MA               | Aluminium chromium-plated | B          |                         | <b>704.120.0</b>   | 5 9                 | 45                | 0.070           |  |
|   |                  |                  |                           | C          |                         | <b>704.121.0</b>   | 5 9                 | 45                | 0.070           |  |
|   |                  |                  |                           | C + B      |                         | <b>704.122.0</b>   | 5 9                 | 45                | 0.070           |  |

Switching action: M = Momentary action, MA = Maintained action

Mounting dimensions from page 91, Technical drawing from page 95, Circuit drawing from page 115

## Keylock switch actuator 3 positions



### Essential Accessories:

Switching element page 51



|   | Front protection | Frontbezel/-ring             | Switching action | Key remove | 30 x 30 mm<br>Typ-Nr. | Ø 29 mm<br>Typ-Nr. | Mounting dimensions | Technical drawing | Circuit drawing |       |
|---|------------------|------------------------------|------------------|------------|-----------------------|--------------------|---------------------|-------------------|-----------------|-------|
| <b>Keylock switch actuator 3 positions</b><br>Position C : Maintained action 42°<br>Position A : Basic position<br>Position B : Momentary action 42°<br>Standard lock 251 | IP 65            | Plastic grey                 | MA-0-M           | C          | <b>704.337.0</b>      |                    | 5                   | 9                 | 46              | 0.070 |
|   |                  |                              |                  | C + A      | <b>704.344.0</b>      |                    | 5                   | 9                 | 46              | 0.070 |
| Position C : Momentary action 42°<br>Position A : Basic position<br>Position B : Maintained action 42°<br>Standard lock 251   | IP 65            | Plastic grey                 | M-0-MA           | A          | <b>704.338.0</b>      |                    | 5                   | 9                 | 43              | 0.070 |
| Position C + B : Maintained action 42°<br>Position A : Basic position<br>Standard lock 251  | IP 65            | Plastic grey                 | MA-0-MA          | A          | <b>704.334.0</b>      |                    | 5                   | 9                 | 47              | 0.070 |
|   |                  |                              |                  | C + B      | <b>704.336.0</b>      |                    | 5                   | 9                 | 47              | 0.070 |
| Position C + B : Maintained action 90°<br>Position A : Basic position<br>Standard lock 251  | IP 65            | Plastic grey                 | MA-0-MA          | C + A + B  | <b>704.333.0</b>      |                    | 5                   | 9                 | 47              | 0.070 |
| Position C + B : Momentary action 42°<br>Position A : Basic position<br>Standard lock 251   | IP 65            | Plastic grey                 | M-0-M            | A          | <b>704.335.0</b>      |                    | 5                   | 9                 | 42              | 0.070 |
| Position C : Maintained action 42°<br>Position A : Basic position<br>Position B : Momentary action 42°<br>Standard lock 251   | IP 65            | Aluminium<br>chromium-plated | MA-0-M           | C          |                       | <b>704.117.0</b>   | 5                   | 9                 | 46              | 0.070 |
|   |                  |                              |                  | C + A      |                       | <b>704.124.0</b>   | 5                   | 9                 | 46              | 0.070 |
| Position C : Momentary action 42°<br>Position A : Basic position<br>Position B : Maintained action 42°<br>Standard lock 251   | IP 65            | Aluminium<br>chromium-plated | M-0-MA           | A          |                       | <b>704.118.0</b>   | 5                   | 9                 | 43              | 0.070 |
| Position C + B : Maintained action 42°<br>Position A : Basic position<br>Standard lock 251  | IP 65            | Aluminium<br>chromium-plated | MA-0-MA          | A          |                       | <b>704.114.0</b>   | 5                   | 9                 | 47              | 0.070 |
|   |                  |                              |                  | C + B      |                       | <b>704.116.0</b>   | 5                   | 9                 | 47              | 0.070 |
| Position C + B : Maintained action 90°<br>Position A : Basic position<br>Standard lock 251  | IP 65            | Aluminium<br>chromium-plated | MA-0-MA          | C + A + B  |                       | <b>704.113.0</b>   | 5                   | 9                 | 47              | 0.070 |
| Position C + B : Momentary action 42°<br>Position A : Basic position<br>Standard lock 251   | IP 65            | Aluminium<br>chromium-plated | M-0-M            | A          |                       | <b>704.115.0</b>   | 5                   | 9                 | 42              | 0.070 |

Switching action: MA = Maintained action, M = Momentary action

Mounting dimensions from page 91, Technical drawing from page 95, Circuit drawing from page 115

## Selector switch actuator 2 positions, short lever



### Essential Accessories:

Switching element page 51



|  | Front protection | Switching action | Frontbezel/-ring  | Lever         | Ø 30 x 30 mm<br>Typ-Nr. | Ø 29 mm<br>Typ-Nr. | Mounting dimensions | Technical drawing | Circuit drawing |  |
|--|------------------|------------------|-------------------|---------------|-------------------------|--------------------|---------------------|-------------------|-----------------|--|
| <b>Selector switch actuator 2 positions, short lever</b><br>Position A : Basic position<br>Position B : Momentary action 42° | IP 65            | M                | Plastic grey      | Plastic black | <b>704.512.0</b>        | <b>704.412.0</b>   | 5 11                | 37                | 0.034           |  |
| Position C + B : Maintained action 90°   | IP 65            | MA               | Plastic grey      | Plastic black | <b>704.510.0</b>        | <b>704.410.0</b>   | 5 11                | 38                | 0.034           |  |
| Position A : Basic position<br>Position B : Momentary action 42°   | IP 65            | M                | Aluminium natural | Plastic black |                         | <b>704.413.0</b>   | 5 11                | 37                | 0.037           |  |
| Position C + B : Maintained action 90°   | IP 65            | MA               | Aluminium natural | Plastic black |                         | <b>704.411.0</b>   | 5 11                | 38                | 0.037           |  |

Switching action: M = Momentary action, MA = Maintained action

Mounting dimensions from page 91, Technical drawing from page 95, Circuit drawing from page 115

## Selector switch actuator 2 positions, short lever, 12 o'clock



### Essential Accessories:

Switching element page 51



|  | Front protection | Switching action | Frontbezel/-ring | Lever         | Ø 30 x 30 mm<br>Typ-Nr. | Ø 29 mm<br>Typ-Nr.  | Mounting dimensions | Technical drawing | Circuit drawing |  |
|--|------------------|------------------|------------------|---------------|-------------------------|---------------------|---------------------|-------------------|-----------------|--|
| <b>Selector switch actuator 2 positions, short lever, 12 o'clock</b><br>Position C + B : Maintained action 90° | IP 65            | MA               | Plastic grey     | Plastic black | <b>704.510.0.12</b>     | <b>704.410.0.12</b> | 5 11                | 38                | 0.034           |  |
| Aluminium black  |                  |                  | Plastic black    |               | <b>704.411.0B.12</b>    | 5 11                | 38                  | 0.037             |                 |  |
| Aluminium natural  |                  |                  | Plastic black    |               | <b>704.411.0.12</b>     | 5 11                | 38                  | 0.037             |                 |  |

Switching action: MA = Maintained action

Mounting dimensions from page 91, Technical drawing from page 95, Circuit drawing from page 115

## Selector switch actuator 2 positions, long lever



### Essential Accessories:

Switching element page 51



|   | Front protection | Switching action | Frontbezel/-ring  | Lever         | ∅ 30 x 30 mm<br>Typ-Nr. | ∅ 29 mm<br>Typ-Nr. | Mounting dimensions | Technical drawing | Circuit drawing |  |
|---|------------------|------------------|-------------------|---------------|-------------------------|--------------------|---------------------|-------------------|-----------------|--|
| <b>Selector switch actuator 2 positions, long lever</b><br>Position A : Basic position<br>Position B : Momentary action 42° | IP 65            | M                | Plastic grey      | Plastic black | <b>704.302.0</b>        | <b>704.102.0</b>   | 6 10                | 37                | 0.034           |  |
| Position C + B : Maintained action 90°  | IP 65            | MA               | Plastic grey      | Plastic black | <b>704.300.0</b>        | <b>704.100.0</b>   | 6 10                | 38                | 0.034           |  |
| Position A : Basic position<br>Position B : Momentary action 42°  | IP 65            | M                | Aluminium natural | Plastic black |                         | <b>704.103.0</b>   | 6 10                | 37                | 0.037           |  |
| Position C + B : Maintained action 90°  | IP 65            | MA               | Aluminium natural | Plastic black |                         | <b>704.101.0</b>   | 6 10                | 38                | 0.037           |  |

Switching action: M = Momentary action, MA = Maintained action

Mounting dimensions from page 91, Technical drawing from page 95, Circuit drawing from page 115

## Selector switch actuator 2 positions, long lever, 12 o'clock



### Essential Accessories:

Switching element page 51



|   | Front protection | Switching action | Frontbezel/-ring | Lever         | ∅ 30 x 30 mm<br>Typ-Nr. | ∅ 29 mm<br>Typ-Nr.  | Mounting dimensions | Technical drawing | Circuit drawing |  |
|---|------------------|------------------|------------------|---------------|-------------------------|---------------------|---------------------|-------------------|-----------------|--|
| <b>Selector switch actuator 2 positions, long lever, 12 o'clock</b><br>Position C + B : Maintained action 90° | IP 65            | MA               | Plastic grey     | Plastic black | <b>704.300.0.12</b>     | <b>704.100.0.12</b> | 6 10                | 38                | 0.034           |  |
| Aluminium black   |                  |                  | Plastic black    |               | <b>704.101.0D.12</b>    | 6 10                | 38                  | 0.037             |                 |  |
| Aluminium natural   |                  |                  | Plastic black    |               | <b>704.101.0.12</b>     | 6 10                | 38                  | 0.037             |                 |  |

Switching action: MA = Maintained action

Mounting dimensions from page 91, Technical drawing from page 95, Circuit drawing from page 115

## Selector switch actuator 3 positions, short lever



### Essential Accessories:

Switching element page 51

Maintain/Momentary

42°



|  | Front protection | Switching action | Frontbezel/-ring  | Lever         | ∅ 30 x 30 mm<br>Typ-Nr. | ∅ 29 mm<br>Typ-Nr. | Mounting dimensions | Technical drawing | Circuit drawing | kg    |
|--|------------------|------------------|-------------------|---------------|-------------------------|--------------------|---------------------|-------------------|-----------------|-------|
| <b>Selector switch actuator 3 positions, short lever</b><br>Position C : Maintained action 42°<br>Position A : Basic position<br>Position B : Momentary action 42° | IP 65            | MA-0-M           | Plastic grey      | Plastic black | <b>704.506.0</b>        | <b>704.406.0</b>   | 5                   | 11                | 39              | 0.034 |
| Position C : Momentary action 42°<br>Position A : Basic position<br>Position B : Maintained action 42°   | IP 65            | M-0-MA           | Plastic grey      | Plastic black | <b>704.508.0</b>        | <b>704.408.0</b>   | 5                   | 11                | 36              | 0.034 |
| Position C + B : Maintained action 42°<br>Position A : Basic position  | IP 65            | MA-0-MA          | Plastic grey      | Plastic black | <b>704.502.0</b>        | <b>704.402.0</b>   | 5                   | 11                | 40              | 0.034 |
| Position C + B : Momentary action 42°<br>Position A : Basic position   | IP 65            | M-0-M            | Plastic grey      | Plastic black | <b>704.504.0</b>        | <b>704.404.0</b>   | 5                   | 11                | 35              | 0.034 |
| Position C : Maintained action 42°<br>Position A : Basic position<br>Position B : Momentary action 42°   | IP 65            | MA-0-M           | Aluminium natural | Plastic black |                         | <b>704.407.0</b>   | 5                   | 11                | 39              | 0.037 |
| Position C : Momentary action 42°<br>Position A : Basic position<br>Position B : Maintained action 42°   | IP 65            | M-0-MA           | Aluminium natural | Plastic black |                         | <b>704.409.0</b>   | 5                   | 11                | 36              | 0.037 |
| Position C + B : Maintained action 42°<br>Position A : Basic position  | IP 65            | MA-0-MA          | Aluminium natural | Plastic black |                         | <b>704.403.0</b>   | 5                   | 11                | 40              | 0.037 |
| Position C + B : Momentary action 42°<br>Position A : Basic position   | IP 65            | M-0-M            | Aluminium natural | Plastic black |                         | <b>704.405.0</b>   | 5                   | 11                | 35              | 0.037 |

Switching action: MA = Maintained action, M = Momentary action

Mounting dimensions from page 91, Technical drawing from page 95, Circuit drawing from page 115

## Selector switch actuator 3 positions, long lever



### Essential Accessories:

Switching element page 51



|   | Front protection | Switching action | Frontbezel/-ring  | Lever         | □ 30 x 30 mm<br>Typ-Nr. | ∅ 29 mm<br>Typ-Nr. | Mounting dimensions | Technical drawing | Circuit drawing |  |
|---|------------------|------------------|-------------------|---------------|-------------------------|--------------------|---------------------|-------------------|-----------------|--|
| <b>Selector switch actuator 3 positions, long lever</b><br>Position C : Maintained action 42°<br>Position A : Basic position<br>Position B : Momentary action 42° | IP 65            | MA-0-M           | Plastic grey      | Plastic black | <b>704.296.0</b>        | <b>704.096.0</b>   | 6 10 39             | 0.034             |                 |  |
| Position C : Momentary action 42°<br>Position A : Basic position<br>Position B : Maintained action 42°  | IP 65            | M-0-MA           | Plastic grey      | Plastic black | <b>704.298.0</b>        | <b>704.098.0</b>   | 6 10 36             | 0.034             |                 |  |
| Position C + B : Maintained action 42°<br>Position A : Basic position   | IP 65            | MA-0-MA          | Plastic grey      | Plastic black | <b>704.292.0</b>        | <b>704.092.0</b>   | 6 10 40             | 0.034             |                 |  |
| Position C + B : Momentary action 42°<br>Position A : Basic position  | IP 65            | M-0-M            | Plastic grey      | Plastic black | <b>704.294.0</b>        | <b>704.094.0</b>   | 6 10 35             | 0.034             |                 |  |
| Position C : Maintained action 42°<br>Position A : Basic position<br>Position B : Momentary action 42°  | IP 65            | MA-0-M           | Aluminium natural | Plastic black |                         | <b>704.097.0</b>   | 6 10 39             | 0.037             |                 |  |
| Position C : Momentary action 42°<br>Position A : Basic position<br>Position B : Maintained action 42°  | IP 65            | M-0-MA           | Aluminium natural | Plastic black |                         | <b>704.099.0</b>   | 6 10 36             | 0.037             |                 |  |
| Position C + B : Maintained action 42°<br>Position A : Basic position   | IP 65            | MA-0-MA          | Aluminium natural | Plastic black |                         | <b>704.093.0</b>   | 6 10 40             | 0.037             |                 |  |
| Position C + B : Momentary action 42°<br>Position A : Basic position  | IP 65            | M-0-M            | Aluminium natural | Plastic black |                         | <b>704.095.0</b>   | 6 10 35             | 0.037             |                 |  |

Switching action: MA = Maintained action, M = Momentary action

Mounting dimensions from page 91, Technical drawing from page 95, Circuit drawing from page 115



## Rotary selector switch actuator, short lever



### Essential Accessories:

-  Rotary selector switching element 30° page 55
-  Rotary selector switching element 45° page 55
-  Rotary selector switching element 60° page 56

|  | Front protection | Frontbezel/-ring  | Lever         | ∅ 30 x 30 mm<br>Typ-Nr. | ∅ 29 mm<br>Typ-Nr. | Mounting dimensions | Technical drawing |       |
|--|------------------|-------------------|---------------|-------------------------|--------------------|---------------------|-------------------|-------|
| <b>Rotary selector switch actuator, short lever</b><br>Position 0 : nine o'clock | IP 65            | Plastic grey      | Plastic black | <b>704.510.1KN</b>      |                    | 4                   | 69                | 0.045 |
|  |                  | Aluminium natural | Plastic black |                         | <b>704.411.1KN</b> | 4                   | 69                | 0.045 |

Mounting dimensions from page 91, Technical drawing from page 95

## Rotary selector switch actuator, long lever



### Essential Accessories:

-  Rotary selector switching element 30° page 55
-  Rotary selector switching element 45° page 55
-  Rotary selector switching element 60° page 56

|   | Front protection | Frontbezel/-ring  | Lever         | ∅ 30 x 30 mm<br>Typ-Nr. | ∅ 29 mm<br>Typ-Nr. | Mounting dimensions | Technical drawing |       |
|---|------------------|-------------------|---------------|-------------------------|--------------------|---------------------|-------------------|-------|
| <b>Rotary selector switch actuator, long lever</b><br>Position 0 : nine o'clock | IP 65            | Plastic grey      | Plastic black | <b>704.300.1KN</b>      |                    | 4                   | 70                | 0.045 |
|   |                  | Aluminium natural | Plastic black |                         | <b>704.101.1KN</b> | 4                   | 70                | 0.045 |
| Position 0 : twelve o'clock   | IP 65            | Aluminium natural | Plastic black |                         | <b>704.101.0KN</b> | 4                   | 70                | 0.045 |

Mounting dimensions from page 91, Technical drawing from page 95

## Indicator, flush mounting



### Essential Accessories:

 Single-LED page 58

|                                  | Front protection | Terminals | Frontbezel/-ring  | Lens               | ∅ 35 x 35 mm<br>Typ-Nr. | ∅ 35 mm<br>Typ-Nr. | Mounting dimensions | Technical drawing | Circuit drawing |  |
|----------------------------------|------------------|-----------|-------------------|--------------------|-------------------------|--------------------|---------------------|-------------------|-----------------|---|
| <b>Indicator, flush mounting</b> | IP 65            | ST        | Plastic black     | Plastic blue       | <b>704.206.600</b>      |                    | 12                  | 20                | 5               | 0.061   |
|                                  |                  |           |                   | Plastic colourless | <b>704.206.700</b>      |                    | 12                  | 20                | 5               | 0.061   |
|                                  |                  |           |                   | Plastic green      | <b>704.206.500</b>      |                    | 12                  | 20                | 5               | 0.061   |
|                                  |                  |           |                   | Plastic red        | <b>704.206.200</b>      |                    | 12                  | 20                | 5               | 0.061   |
|                                  |                  |           |                   | Plastic yellow     | <b>704.206.400</b>      |                    | 12                  | 20                | 5               | 0.061   |
|                                  |                  |           | Plastic silver    | Plastic blue       | <b>704.202.608</b>      |                    | 12                  | 20                | 5               | 0.061   |
|                                  |                  |           |                   | Plastic colourless | <b>704.202.708</b>      |                    | 12                  | 20                | 5               | 0.061   |
|                                  |                  |           |                   | Plastic green      | <b>704.202.508</b>      |                    | 12                  | 20                | 5               | 0.061   |
|                                  |                  |           |                   | Plastic red        | <b>704.202.208</b>      |                    | 12                  | 20                | 5               | 0.061   |
|                                  |                  |           |                   | Plastic yellow     | <b>704.202.408</b>      |                    | 12                  | 20                | 5               | 0.061   |
|                                  |                  |           | Aluminium natural | Plastic blue       |                         | <b>704.006.618</b> | 7                   | 20                | 5               | 0.061   |
|                                  |                  |           |                   | Plastic colourless |                         | <b>704.006.718</b> | 7                   | 20                | 5               | 0.061   |
|                                  |                  |           |                   | Plastic green      |                         | <b>704.006.518</b> | 7                   | 20                | 5               | 0.061   |
|                                  |                  |           |                   | Plastic red        |                         | <b>704.006.218</b> | 7                   | 20                | 5               | 0.061   |
|                                  |                  |           |                   | Plastic yellow     |                         | <b>704.006.418</b> | 7                   | 20                | 5               | 0.061   |

Terminals: ST = Screw terminal

Mounting dimensions from page 91, Technical drawing from page 95, Circuit drawing from page 115

## Flasher, flush mounting



### Essential Accessories:

- Flasher element page 50
- Single-LED page 58

|                                | Front protection | Frontbezel/-ring  | Lens               | Ø 35 x 35 mm<br>Typ-Nr. | Ø 35 mm<br>Typ-Nr. | Mounting dimensions | Technical drawing | Circuit drawing |       |       |
|--------------------------------|------------------|-------------------|--------------------|-------------------------|--------------------|---------------------|-------------------|-----------------|-------|-------|
| <b>Flasher, flush mounting</b> | IP 65            | Plastic black     | Plastic blue       | <b>704.206.600</b>      |                    | 12                  | 21                | 5               | 0.061 |       |
|                                |                  |                   | Plastic colourless | <b>704.206.700</b>      |                    | 12                  | 21                | 5               | 0.061 |       |
|                                |                  |                   | Plastic green      | <b>704.206.500</b>      |                    | 12                  | 21                | 5               | 0.061 |       |
|                                |                  |                   | Plastic red        | <b>704.206.200</b>      |                    | 12                  | 21                | 5               | 0.061 |       |
|                                |                  |                   | Plastic yellow     | <b>704.206.400</b>      |                    | 12                  | 21                | 5               | 0.061 |       |
|                                |                  | Plastic silver    | Plastic blue       | <b>704.202.608</b>      |                    | 12                  | 21                | 5               | 0.061 |       |
|                                |                  |                   | Plastic colourless | <b>704.202.708</b>      |                    | 12                  | 21                | 5               | 0.061 |       |
|                                |                  |                   | Plastic green      | <b>704.202.508</b>      |                    | 12                  | 21                | 5               | 0.061 |       |
|                                |                  |                   | Plastic red        | <b>704.202.208</b>      |                    | 12                  | 21                | 5               | 0.061 |       |
|                                |                  |                   | Plastic yellow     | <b>704.202.408</b>      |                    | 12                  | 21                | 5               | 0.061 |       |
|                                |                  | Aluminium natural | Plastic blue       |                         |                    | <b>704.006.618</b>  | 7                 | 21              | 5     | 0.061 |
|                                |                  |                   | Plastic colourless |                         |                    | <b>704.006.718</b>  | 7                 | 21              | 5     | 0.061 |
|                                |                  |                   | Plastic green      |                         |                    | <b>704.006.518</b>  | 7                 | 21              | 5     | 0.061 |
|                                |                  |                   | Plastic red        |                         |                    | <b>704.006.218</b>  | 7                 | 21              | 5     | 0.061 |
|                                |                  |                   | Plastic yellow     |                         |                    | <b>704.006.418</b>  | 7                 | 21              | 5     | 0.061 |

Mounting dimensions from page 91, Technical drawing from page 95, Circuit drawing from page 115

## Buzzer, flush mounting



|   | Front protection | Front cap         | Terminals | Ø 35 mm<br>Typ-Nr. | Mounting dimensions | Technical drawing | Circuit drawing |       |
|---|------------------|-------------------|-----------|--------------------|---------------------|-------------------|-----------------|-------|
| <b>Buzzer, flush mounting</b><br>Operation voltage : 24 VDC | IP 40            | Aluminium black   | S1        | <b>14-810.910</b>  | 7                   | 68                | 1               | 0.016 |
|   |                  | Aluminium natural | S1        | <b>14-810.918</b>  | 7                   | 68                | 1               | 0.016 |

Further information in the Technical Data and Typical Applications

Terminals: S1 = Soldering terminal (also pluggable 2.8 x 0.5 mm)

Mounting dimensions from page 91, Technical drawing from page 95, Circuit drawing from page 115

## Pushbutton actuator, flush mounting

non-illuminative



### Essential Accessories:

Switching element page 51

|  | Front protection | Switching action | Frontbezel/-ring   | Lens               | ∅ 35 x 35 mm<br>Typ-Nr. | ∅ 35 mm<br>Typ-Nr. | Mounting dimensions | Technical drawing | Circuit drawing | (E-3) |       |
|--|------------------|------------------|--------------------|--------------------|-------------------------|--------------------|---------------------|-------------------|-----------------|-------|-------|
| <b>Pushbutton actuator, flush mounting</b> | IP 65            | MA               | Plastic black      | Plastic black      | <b>704.239.000</b>      |                    | 12                  | 22                | 3               | 0.051 |       |
|  |                  |                  |                    | Plastic blue       | <b>704.239.600</b>      |                    | 12                  | 22                | 3               | 0.051 |       |
|  |                  |                  |                    | Plastic colourless | <b>704.239.700</b>      |                    | 12                  | 22                | 3               | 0.051 |       |
|  |                  |                  |                    | Plastic green      | <b>704.239.500</b>      |                    | 12                  | 22                | 3               | 0.051 |       |
|  |                  |                  |                    | Plastic red        | <b>704.239.200</b>      |                    | 12                  | 22                | 3               | 0.051 |       |
|  |                  |                  |                    | Plastic yellow     | <b>704.239.400</b>      |                    | 12                  | 22                | 3               | 0.051 |       |
|  |                  |                  | Plastic silver     | Plastic black      | <b>704.240.008</b>      |                    | 12                  | 22                | 4               | 0.051 |       |
|  |                  |                  |                    | Plastic blue       | <b>704.240.608</b>      |                    | 12                  | 22                | 3               | 0.051 |       |
|  |                  |                  |                    | Plastic colourless | <b>704.240.708</b>      |                    | 12                  | 22                | 3               | 0.051 |       |
|  |                  |                  |                    | Plastic green      | <b>704.240.508</b>      |                    | 12                  | 22                | 3               | 0.051 |       |
|  |                  |                  |                    | Plastic red        | <b>704.240.208</b>      |                    | 12                  | 22                | 3               | 0.051 |       |
|  |                  |                  |                    | Plastic yellow     | <b>704.240.408</b>      |                    | 12                  | 22                | 3               | 0.051 |       |
|  |                  |                  | M                  | Plastic black      | Plastic black           | <b>704.209.000</b> |                     | 12                | 22              | 4     | 0.051 |
|  |                  |                  |                    |                    | Plastic blue            | <b>704.209.600</b> |                     | 12                | 22              | 4     | 0.051 |
|  |                  |                  |                    |                    | Plastic colourless      | <b>704.209.700</b> |                     | 12                | 22              | 4     | 0.051 |
|  |                  |                  |                    |                    | Plastic green           | <b>704.209.500</b> |                     | 12                | 22              | 4     | 0.051 |
|  |                  |                  |                    |                    | Plastic red             | <b>704.209.200</b> |                     | 12                | 22              | 4     | 0.051 |
|  |                  |                  |                    |                    | Plastic yellow          | <b>704.209.400</b> |                     | 12                | 22              | 4     | 0.051 |
|  |                  | Plastic silver   |                    | Plastic black      | <b>704.210.008</b>      |                    | 12                  | 22                | 4               | 0.051 |       |
|  |                  |                  |                    | Plastic blue       | <b>704.210.608</b>      |                    | 12                  | 22                | 4               | 0.051 |       |
|  |                  |                  |                    | Plastic colourless | <b>704.210.708</b>      |                    | 12                  | 22                | 4               | 0.051 |       |
|  |                  |                  |                    | Plastic green      | <b>704.210.508</b>      |                    | 12                  | 22                | 4               | 0.051 |       |
|  |                  |                  |                    | Plastic red        | <b>704.210.208</b>      |                    | 12                  | 22                | 4               | 0.051 |       |
|  |                  |                  |                    | Plastic yellow     | <b>704.210.408</b>      |                    | 12                  | 22                | 4               | 0.051 |       |
|  |                  | MA               |                    | Aluminium natural  | Aluminium black         |                    | <b>704.041.018</b>  | 7                 | 22              | 3     | 0.051 |
|  |                  |                  |                    |                    | Aluminium blue          |                    | <b>704.041.618</b>  | 7                 | 22              | 3     | 0.051 |
|  |                  |                  |                    |                    | Aluminium gold          |                    | <b>704.041.418</b>  | 7                 | 22              | 3     | 0.051 |
|  |                  |                  |                    |                    | Aluminium natural       |                    | <b>704.041.818</b>  | 7                 | 22              | 3     | 0.051 |
|  |                  |                  |                    |                    | Aluminium olive-green   |                    | <b>704.041.518</b>  | 7                 | 22              | 3     | 0.051 |
|  |                  |                  |                    |                    | Aluminium red           |                    | <b>704.041.218</b>  | 7                 | 22              | 3     | 0.051 |
|  |                  |                  | Plastic black      |                    |                         | <b>704.042.018</b> | 7                   | 22                | 3               | 0.051 |       |
|  |                  |                  | Plastic blue       |                    |                         | <b>704.042.618</b> | 7                   | 22                | 3               | 0.051 |       |
|  |                  |                  | Plastic colourless |                    |                         | <b>704.042.718</b> | 7                   | 22                | 3               | 0.051 |       |
|  |                  |                  | Plastic green      |                    |                         | <b>704.042.518</b> | 7                   | 22                | 3               | 0.051 |       |
|  |                  |                  | Plastic red        |                    |                         | <b>704.042.218</b> | 7                   | 22                | 3               | 0.051 |       |
|  |                  |                  | Plastic yellow     |                    |                         | <b>704.042.418</b> | 7                   | 22                | 3               | 0.051 |       |

Continuation see next page

Continued from previous page

|  | Front protection | Switching action | Frontbezel/-ring  | Lens                  | ⌀ 35 x 35 mm<br>Typ-Nr. | Ø 35 mm<br>Typ-Nr. | Mounting dimensions | Technical drawing | Circuit drawing |       |
|--|------------------|------------------|-------------------|-----------------------|-------------------------|--------------------|---------------------|-------------------|-----------------|-------|
| <b>Pushbutton actuator, flush mounting</b> | IP 65            | M                | Aluminium natural | Aluminium black       |                         | <b>704.011.018</b> | 7                   | 22                | 4               | 0.051 |
|  |                  |                  |                   | Aluminium blue        |                         | <b>704.011.618</b> | 7                   | 22                | 4               | 0.051 |
|  |                  |                  |                   | Aluminium gold        |                         | <b>704.011.418</b> | 7                   | 22                | 4               | 0.051 |
|  |                  |                  |                   | Aluminium natural     |                         | <b>704.011.818</b> | 7                   | 22                | 4               | 0.051 |
|  |                  |                  |                   | Aluminium olive-green |                         | <b>704.011.518</b> | 7                   | 22                | 4               | 0.051 |
|  |                  |                  |                   | Aluminium red         |                         | <b>704.011.218</b> | 7                   | 22                | 4               | 0.051 |
|  |                  |                  |                   | Plastic black         |                         | <b>704.012.018</b> | 7                   | 22                | 4               | 0.051 |
|  |                  |                  |                   | Plastic blue          |                         | <b>704.012.618</b> | 7                   | 22                | 4               | 0.051 |
|  |                  |                  |                   | Plastic colourless    |                         | <b>704.012.718</b> | 7                   | 22                | 4               | 0.051 |
|  |                  |                  |                   | Plastic green         |                         | <b>704.012.518</b> | 7                   | 22                | 4               | 0.051 |
|  |                  |                  |                   | Plastic red           |                         | <b>704.012.218</b> | 7                   | 22                | 4               | 0.051 |
|  |                  |                  |                   | Plastic yellow        |                         | <b>704.012.418</b> | 7                   | 22                | 4               | 0.051 |

Switching action: MA = Maintained action, M = Momentary action

Mounting dimensions from page 91, Technical drawing from page 95, Circuit drawing from page 115

## Illuminated pushbutton actuator, flush mounting



### Essential Accessories:

- Single-LED page 58
- Switching element page 51

|  | Front protection | Switching action  | Frontbezel/-ring   | Lens               | ∅ 35 x 35 mm<br>Typ-Nr. | ∅ 35 mm<br>Typ-Nr. | Mounting dimensions |                 |       |       |
|--|------------------|-------------------|--------------------|--------------------|-------------------------|--------------------|---------------------|-----------------|-------|-------|
|  |                  |                   |                    |                    |                         |                    | Technical drawing   | Circuit drawing |       |       |
| <b>Illuminated pushbutton actuator, flush mounting</b> | IP 65            | MA                | Plastic black      | Plastic blue       | <b>704.259.600</b>      |                    | 12                  | 19              | 3     | 0.051 |
|  |                  |                   |                    | Plastic colourless | <b>704.259.700</b>      |                    | 12                  | 19              | 3     | 0.051 |
|  |                  |                   |                    | Plastic green      | <b>704.259.500</b>      |                    | 12                  | 19              | 3     | 0.051 |
|  |                  |                   |                    | Plastic red        | <b>704.259.200</b>      |                    | 12                  | 19              | 3     | 0.051 |
|  |                  |                   |                    | Plastic yellow     | <b>704.259.400</b>      |                    | 12                  | 19              | 3     | 0.051 |
|  |                  |                   | Plastic silver     | Plastic blue       | <b>704.260.608</b>      |                    | 12                  | 19              | 3     | 0.051 |
|  |                  |                   |                    | Plastic colourless | <b>704.260.708</b>      |                    | 12                  | 19              | 3     | 0.051 |
|  |                  |                   |                    | Plastic green      | <b>704.260.508</b>      |                    | 12                  | 19              | 3     | 0.051 |
|  |                  |                   |                    | Plastic red        | <b>704.260.208</b>      |                    | 12                  | 19              | 3     | 0.051 |
|  |                  | M                 | Plastic black      | Plastic blue       | <b>704.229.600</b>      |                    | 12                  | 19              | 4     | 0.051 |
|  |                  |                   |                    | Plastic colourless | <b>704.229.700</b>      |                    | 12                  | 19              | 4     | 0.051 |
|  |                  |                   |                    | Plastic green      | <b>704.229.500</b>      |                    | 12                  | 19              | 4     | 0.051 |
|  |                  |                   |                    | Plastic red        | <b>704.229.200</b>      |                    | 12                  | 19              | 4     | 0.051 |
|  |                  |                   |                    | Plastic yellow     | <b>704.229.400</b>      |                    | 12                  | 19              | 4     | 0.051 |
|  |                  |                   | Plastic silver     | Plastic blue       | <b>704.230.608</b>      |                    | 12                  | 19              | 4     | 0.051 |
|  |                  |                   |                    | Plastic colourless | <b>704.230.708</b>      |                    | 12                  | 19              | 4     | 0.051 |
|  |                  |                   |                    | Plastic green      | <b>704.230.508</b>      |                    | 12                  | 19              | 4     | 0.051 |
|  |                  |                   |                    | Plastic red        | <b>704.230.208</b>      |                    | 12                  | 19              | 4     | 0.051 |
|  | MA               | Aluminium natural | Plastic blue       |                    | <b>704.062.618</b>      | 7                  | 19                  | 34              | 0.067 |       |
|  |                  |                   | Plastic colourless |                    | <b>704.062.718</b>      | 7                  | 19                  | 34              | 0.067 |       |
|  |                  |                   | Plastic green      |                    | <b>704.062.518</b>      | 7                  | 19                  | 34              | 0.067 |       |
|  |                  |                   | Plastic red        |                    | <b>704.062.218</b>      | 7                  | 19                  | 34              | 0.067 |       |
|  |                  |                   | Plastic yellow     |                    | <b>704.062.418</b>      | 7                  | 19                  | 34              | 0.067 |       |
|  | M                | Aluminium natural | Plastic blue       |                    | <b>704.032.618</b>      | 7                  | 19                  | 41              | 0.067 |       |
|  |                  |                   | Plastic colourless |                    | <b>704.032.718</b>      | 7                  | 19                  | 41              | 0.067 |       |
|  |                  |                   | Plastic green      |                    | <b>704.032.518</b>      | 7                  | 19                  | 41              | 0.067 |       |
|  |                  |                   | Plastic red        |                    | <b>704.032.218</b>      | 7                  | 19                  | 41              | 0.067 |       |
|  |                  |                   | Plastic yellow     |                    | <b>704.032.418</b>      | 7                  | 19                  | 41              | 0.067 |       |

Switching action: MA = Maintained action, M = Momentary action

Mounting dimensions from page 91, Technical drawing from page 95, Circuit drawing from page 115

## Stop pushbutton actuator, flush mounting



### Essential Accessories:

Switching element for Emergency-stop pushbutton page 54

|  | Front protection | Switching action | Front ring        | Mushroom had cap | Marking | Ø 40 mm<br>Typ-Nr. | Mounting dimensions | Technical drawing | Circuit drawing |       |
|--|------------------|------------------|-------------------|------------------|---------|--------------------|---------------------|-------------------|-----------------|-------|
| <b>Stop pushbutton actuator, flush mounting</b><br>Twist to unlock clockwise | IP 65            | MA               | Aluminium black   | Plastic red      | Arrows  | <b>704.074.210</b> | 10                  | 26                | 6               | 0.048 |
|  |                  |                  |                   |                  | Stop    | <b>704.075.310</b> | 10                  | 26                | 6               | 0.048 |
|  |                  |                  | Aluminium natural | Plastic red      | Arrows  | <b>704.075.218</b> | 10                  | 26                | 6               | 0.048 |
|  |                  |                  |                   |                  | Stop    | <b>704.075.318</b> | 10                  | 26                | 6               | 0.048 |

Switching action: MA = Maintained action

Mounting dimensions from page 91, Technical drawing from page 95, Circuit drawing from page 115

## Mushroom-head pushbutton actuator, flush mounting



### Essential Accessories:

Switching element page 51

|  | Front protection | Front ring        | Switching action | Mushroom had cap   | Ø 40 mm<br>Typ-Nr. | Mounting dimensions | Technical drawing | Circuit drawing |       |
|--|------------------|-------------------|------------------|--------------------|--------------------|---------------------|-------------------|-----------------|-------|
| <b>Mushroom-head pushbutton actuator, flush mounting</b> | IP 65            | Aluminium black   | MA               | Plastic red        | <b>704.073.210</b> | 10                  | 27                | 3               | 0.041 |
|  |                  |                   |                  | Plastic red        | <b>704.071.210</b> | 10                  | 27                | 4               | 0.041 |
|  |                  |                   | Plastic yellow   | <b>704.071.410</b> | 10                 | 27                  | 4                 | 0.041           |       |
|  |                  | Aluminium natural | M                | Plastic red        | <b>704.071.218</b> | 10                  | 27                | 4               | 0.041 |
|  |                  |                   |                  | Plastic yellow     | <b>704.071.418</b> | 10                  | 27                | 4               | 0.041 |

Switching action: MA = Maintained action, M = Momentary action

Mounting dimensions from page 91, Technical drawing from page 95, Circuit drawing from page 115

## Keylock switch actuator 2 positions, flush mounting



### Essential Accessories:

Switching element page 51



|   | Front protection   | Switching action | Frontbezel/-ring  | Key remove  | 35 x 35 mm<br>Typ-Nr. | Ø 35 mm<br>Typ-Nr. | Mounting dimensions |       |                    | Technical drawing | Circuit drawing |
|---|--------------------|------------------|-------------------|---|-----------------------|--------------------|---------------------|-------|--------------------|-------------------|-----------------|
| <b>Keylock switch actuator 2 positions, flush mounting</b><br>Position A : Basic position<br>Position B : Momentary action 42°<br>Standard lock 251 | IP 65              | M                | Plastic black     | A   | <b>704.343.000</b>    |                    | 12                  | 25    | 44                 | 0.099             |                 |
|   |                    |                  | Plastic silver    | A   | <b>704.343.008</b>    |                    | 12                  | 25    | 44                 | 0.099             |                 |
| Position C + B : Maintained action 90°<br>Standard lock 251   | IP 65              | MA               | Plastic black     | B   | <b>704.340.000</b>    |                    | 12                  | 25    | 45                 | 0.099             |                 |
|   |                    |                  |                   | C   | <b>704.341.000</b>    |                    | 12                  | 25    | 45                 | 0.099             |                 |
|   |                    |                  |                   | C + B   | <b>704.342.000</b>    |                    | 12                  | 25    | 45                 | 0.099             |                 |
|   |                    |                  | Plastic silver    | B   | <b>704.340.008</b>    |                    | 12                  | 25    | 45                 | 0.099             |                 |
|   |                    |                  |                   | C   | <b>704.341.008</b>    |                    | 12                  | 25    | 45                 | 0.099             |                 |
|   |                    |                  |                   | C + B   | <b>704.342.008</b>    |                    | 12                  | 25    | 45                 | 0.099             |                 |
| Position A : Basic position<br>Position B : Momentary action 42°<br>Standard lock 251   | IP 65              | M                | Aluminium natural | A   |                       | <b>704.123.018</b> | 7                   | 25    | 44                 | 0.099             |                 |
|   |                    |                  |                   | Position C + B : Maintained action 90°<br>Standard lock 251 | IP 65                 | MA                 | Aluminium natural   | B     | <b>704.120.018</b> | 7                 | 25              |
| C   | <b>704.121.018</b> | 7                | 25                | 45  |                       |                    |                     | 0.099 |                    |                   |                 |
| C + B   | <b>704.122.018</b> | 7                | 25                | 45  |                       |                    |                     | 0.099 |                    |                   |                 |

Switching action: M = Momentary action, MA = Maintained action

Mounting dimensions from page 91, Technical drawing from page 95, Circuit drawing from page 115



## Keylock switch actuator 3 positions, flush mounting



### Essential Accessories:

Switching element page 51



|   | Front protection | Switching action | Frontbezel/-ring  | Key remove | ⌀ 35 x 35 mm<br>Typ-Nr. | Ø 35 mm<br>Typ-Nr. | Mounting dimensions | Technical drawing | Circuit drawing |       |
|---|------------------|------------------|-------------------|------------|-------------------------|--------------------|---------------------|-------------------|-----------------|-------|
| <b>Keylock switch actuator 3 positions, flush mounting</b><br>Position C : Maintained action 42°<br>Position A : Basic position<br>Position B : Momentary action 42°<br>Standard lock 251 | IP 65            | MA-0-M           | Plastic black     | C          | <b>704.337.000</b>      |                    | 12                  | 25                | 46              | 0.099 |
|   |                  |                  |                   | C + A      | <b>704.344.000</b>      |                    | 12                  | 25                | 46              | 0.099 |
|   |                  |                  | Plastic silver    | C          | <b>704.337.008</b>      |                    | 12                  | 25                | 46              | 0.099 |
|   |                  |                  |                   | C + A      | <b>704.344.008</b>      |                    | 12                  | 25                | 46              | 0.099 |
| Position C : Momentary action 42°<br>Position A : Basic position<br>Position B : Maintained action 42°<br>Standard lock 251   | IP 65            | M-0-MA           | Plastic black     | A          | <b>704.338.000</b>      |                    | 12                  | 25                | 43              | 0.099 |
|   |                  |                  | Plastic silver    | A          | <b>704.338.008</b>      |                    | 12                  | 25                | 43              | 0.099 |
| Position C + B : Maintained action 42°<br>Position A : Basic position<br>Standard lock 251  | IP 65            | MA-0-MA          | Plastic black     | A          | <b>704.334.000</b>      |                    | 12                  | 25                | 47              | 0.099 |
|   |                  |                  |                   | C + B      | <b>704.336.000</b>      |                    | 12                  | 25                | 47              | 0.099 |
|   |                  |                  | Plastic silver    | A          | <b>704.334.008</b>      |                    | 12                  | 25                | 47              | 0.099 |
|   |                  |                  |                   | C + B      | <b>704.336.008</b>      |                    | 12                  | 25                | 47              | 0.099 |
| Position C + B : Maintained action 90°<br>Position A : Basic position<br>Standard lock 251  | IP 65            | MA-0-MA          | Plastic black     | C + A + B  | <b>704.333.000</b>      |                    | 12                  | 25                | 47              | 0.099 |
|   |                  |                  | Plastic silver    | C + A + B  | <b>704.333.008</b>      |                    | 12                  | 25                | 47              | 0.099 |
| Position C + B : Momentary action 42°<br>Position A : Basic position<br>Standard lock 251   | IP 65            | M-0-M            | Plastic black     | A          | <b>704.335.000</b>      |                    | 12                  | 25                | 42              | 0.099 |
|   |                  |                  | Plastic silver    | A          | <b>704.335.008</b>      |                    | 12                  | 25                | 42              | 0.099 |
| Position C : Maintained action 42°<br>Position A : Basic position<br>Position B : Momentary action 42°<br>Standard lock 251   | IP 65            | MA-0-M           | Aluminium natural | C          |                         | <b>704.117.018</b> | 7                   | 25                | 46              | 0.099 |
|   |                  |                  |                   | C + A      |                         | <b>704.124.018</b> | 7                   | 25                | 46              | 0.099 |
| Position C : Momentary action 42°<br>Position A : Basic position<br>Position B : Maintained action 42°<br>Standard lock 251   | IP 65            | M-0-MA           | Aluminium natural | A          |                         | <b>704.118.018</b> | 7                   | 25                | 43              | 0.099 |
| Position C + B : Maintained action 42°<br>Position A : Basic position<br>Standard lock 251  | IP 65            | MA-0-MA          | Aluminium natural | A          |                         | <b>704.114.018</b> | 7                   | 25                | 47              | 0.099 |
|   |                  |                  |                   | C + B      |                         | <b>704.116.018</b> | 7                   | 25                | 47              | 0.099 |
| Position C + B : Maintained action 90°<br>Position A : Basic position<br>Standard lock 251  | IP 65            | MA-0-MA          | Aluminium natural | C + A + B  |                         | <b>704.113.018</b> | 7                   | 25                | 47              | 0.099 |
| Position C + B : Momentary action 42°<br>Position A : Basic position<br>Standard lock 251   | IP 65            | M-0-M            | Aluminium natural | A          |                         | <b>704.115.018</b> | 7                   | 25                | 42              | 0.099 |

Switching action: MA = Maintained action, M = Momentary action

Mounting dimensions from page 91, Technical drawing from page 95, Circuit drawing from page 115

## Selector switch actuator 2 positions, short lever, flush mounting



### Essential Accessories:

Switching element page 51

|  | Front protection | Switching action | Frontbezel/-ring  | Lever         | Ø 35 x 35 mm Typ-Nr. | Ø 35 mm Typ-Nr.    | Mounting dimensions | Technical drawing | Circuit drawing |       |
|--|------------------|------------------|-------------------|---------------|----------------------|--------------------|---------------------|-------------------|-----------------|-------|
| Maintain 90°<br><br>Momentary 42°<br>  | IP 65            | M                | Plastic black     | Plastic black | <b>704.512.000</b>   |                    | 12                  | 23                | 37              | 0.056 |
|  |                  |                  | Plastic silver    | Plastic black | <b>704.512.008</b>   |                    | 12                  | 23                | 37              | 0.056 |
| Position A : Basic position<br>Position B : Momentary action 42°<br>Position C + B : Maintained action 90° | IP 65            | MA               | Plastic black     | Plastic black | <b>704.510.000</b>   |                    | 12                  | 23                | 38              | 0.056 |
|  |                  |                  | Plastic silver    | Plastic black | <b>704.510.008</b>   |                    | 12                  | 23                | 38              | 0.056 |
| Position A : Basic position<br>Position B : Momentary action 42°   | IP 65            | M                | Aluminium black   | Plastic black |                      | <b>704.413.010</b> | 7                   | 23                | 37              | 0.056 |
|  |                  |                  | Aluminium natural | Plastic black |                      | <b>704.413.018</b> | 7                   | 23                | 37              | 0.056 |
| Position C + B : Maintained action 90°   | IP 65            | MA               | Aluminium black   | Plastic black |                      | <b>704.411.010</b> | 7                   | 23                | 38              | 0.056 |
|  |                  |                  | Aluminium natural | Plastic black |                      | <b>704.411.018</b> | 7                   | 23                | 38              | 0.056 |

Switching action: M = Momentary action, MA = Maintained action

Mounting dimensions from page 91, Technical drawing from page 95, Circuit drawing from page 115

## Selector switch actuator 2 positions, short lever, 12 o'clock, flush mounting



### Essential Accessories:

Switching element page 51

|                  | Front protection | Switching action | Frontbezel/-ring  | Lever         | Ø 35 x 35 mm Typ-Nr.  | Ø 35 mm Typ-Nr.       | Mounting dimensions | Technical drawing | Circuit drawing |       |
|------------------|------------------|------------------|-------------------|---------------|-----------------------|-----------------------|---------------------|-------------------|-----------------|-------|
| Maintain 90°<br> | IP 65            | MA               | Plastic black     | Plastic black | <b>704.510.000.12</b> |                       | 12                  | 23                | 38              | 0.056 |
|                  |                  |                  | Plastic silver    | Plastic black | <b>704.510.008.12</b> |                       | 12                  | 23                | 38              | 0.056 |
|                  |                  |                  | Aluminium black   | Plastic black |                       | <b>704.411.010.12</b> | 7                   | 23                | 38              | 0.056 |
|                  |                  |                  | Aluminium natural | Plastic black |                       | <b>704.411.018.12</b> | 7                   | 23                | 38              | 0.056 |

Switching action: MA = Maintained action

Mounting dimensions from page 91, Technical drawing from page 95, Circuit drawing from page 115

## Selector switch actuator 2 positions, long lever, flush mounting



### Essential Accessories:

Switching element page 51

|  | Front protection | Switching action | Frontbezel/-ring  | Lever         | Ø 35 x 35 mm<br>Typ-Nr. | Ø 35 mm<br>Typ-Nr. | Mounting dimensions | Technical drawing | Circuit drawing |       |
|--|------------------|------------------|-------------------|---------------|-------------------------|--------------------|---------------------|-------------------|-----------------|-------|
| Maintain 90°<br>   | IP 65            | M                | Plastic black     | Plastic black | <b>704.302.000</b>      |                    | 13                  | 16                | 37              | 0.056 |
|  |                  |                  | Plastic silver    | Plastic black | <b>704.302.008</b>      |                    | 13                  | 16                | 37              | 0.056 |
| Momentary 42°<br>  | IP 65            | MA               | Plastic black     | Plastic black | <b>704.300.000</b>      |                    | 13                  | 16                | 38              | 0.056 |
|  |                  |                  | Plastic silver    | Plastic black | <b>704.300.008</b>      |                    | 13                  | 16                | 38              | 0.056 |
| Position A : Basic position<br>Position B : Momentary action 42° | IP 65            | M                | Aluminium natural | Plastic black |                         | <b>704.103.018</b> | 7                   | 16                | 37              | 0.056 |
| Position C + B : Maintained action 90°                           | IP 65            | MA               | Aluminium natural | Plastic black |                         | <b>704.101.018</b> | 7                   | 16                | 38              | 0.056 |
|  |                  |                  | Plastic black     | Plastic black |                         | <b>704.101.010</b> | 7                   | 16                | 38              | 0.056 |

Switching action: M = Momentary action, MA = Maintained action

Mounting dimensions from page 91, Technical drawing from page 95, Circuit drawing from page 115

## Selector switch actuator 2 positions, long lever, 12 o'clock, flush mounting



### Essential Accessories:

Switching element page 51

|                  | Front protection | Switching action | Frontbezel/-ring  | Lever         | Ø 35 x 35 mm<br>Typ-Nr. | Ø 35 mm<br>Typ-Nr.    | Mounting dimensions | Technical drawing | Circuit drawing |       |
|------------------|------------------|------------------|-------------------|---------------|-------------------------|-----------------------|---------------------|-------------------|-----------------|-------|
| Maintain 90°<br> | IP 65            | MA               | Plastic black     | Plastic black | <b>704.300.000.12</b>   |                       | 13                  | 16                | 38              | 0.056 |
|                  |                  |                  | Plastic silver    | Plastic black | <b>704.300.008.12</b>   |                       | 13                  | 16                | 38              | 0.056 |
|                  |                  |                  | Aluminium natural | Plastic black |                         | <b>704.101.018.12</b> | 7                   | 16                | 38              | 0.056 |
|                  |                  |                  | Plastic black     | Plastic black |                         | <b>704.101.010.12</b> | 7                   | 16                | 38              | 0.056 |

Switching action: MA = Maintained action

Mounting dimensions from page 91, Technical drawing from page 95, Circuit drawing from page 115

## Selector switch actuator 3 positions, short lever, flush mounting



### Essential Accessories:

Switching element page 51

Maintain/Momentary  
42°



|  | Front protection | Switching action | Frontbezel/-ring  | Lever         | Typ-Nr.            | Ø 35 mm Typ-Nr.    | Mounting dimensions |    |    | Technical drawing | Circuit drawing |
|--|------------------|------------------|-------------------|---------------|--------------------|--------------------|---------------------|----|----|-------------------|-----------------|
| <b>Selector switch actuator 3 positions, short lever, flush mounting</b><br>Position C : Maintained action 42°<br>Position A : Basic position<br>Position B : Momentary action 42° | IP 65            | MA-0-M           | Plastic black     | Plastic black | <b>704.506.000</b> |                    | 12                  | 23 | 39 | 0.056             |                 |
|  |                  |                  | Plastic silver    | Plastic black | <b>704.506.008</b> |                    | 12                  | 23 | 39 | 0.056             |                 |
| Position C : Momentary action 42°<br>Position A : Basic position<br>Position B : Maintained action 42°   | IP 65            | M-0-MA           | Plastic black     | Plastic black | <b>704.508.000</b> |                    | 12                  | 23 | 36 | 0.056             |                 |
|  |                  |                  | Plastic silver    | Plastic black | <b>704.508.008</b> |                    | 12                  | 23 | 36 | 0.056             |                 |
| Position C + B : Maintained action 42°<br>Position A : Basic position  | IP 65            | MA-0-MA          | Plastic black     | Plastic black | <b>704.502.000</b> |                    | 12                  | 23 | 40 | 0.056             |                 |
|  |                  |                  | Plastic silver    | Plastic black | <b>704.502.008</b> |                    | 12                  | 23 | 40 | 0.056             |                 |
| Position C + B : Momentary action 42°<br>Position A : Basic position   | IP 65            | M-0-M            | Plastic black     | Plastic black | <b>704.504.000</b> |                    | 12                  | 23 | 35 | 0.056             |                 |
|  |                  |                  | Plastic silver    | Plastic black | <b>704.504.008</b> |                    | 12                  | 23 | 35 | 0.056             |                 |
| Position C : Maintained action 42°<br>Position A : Basic position<br>Position B : Momentary action 42°   | IP 65            | MA-0-M           | Aluminium black   | Plastic black |                    | <b>704.407.010</b> | 7                   | 23 | 39 | 0.056             |                 |
|  |                  |                  | Aluminium natural | Plastic black |                    | <b>704.407.018</b> | 7                   | 23 | 39 | 0.056             |                 |
| Position C : Momentary action 42°<br>Position A : Basic position<br>Position B : Maintained action 42°   | IP 65            | M-0-MA           | Aluminium black   | Plastic black |                    | <b>704.409.010</b> | 7                   | 23 | 36 | 0.056             |                 |
|  |                  |                  | Aluminium natural | Plastic black |                    | <b>704.409.018</b> | 7                   | 23 | 36 | 0.056             |                 |
| Position C + B : Maintained action 42°<br>Position A : Basic position  | IP 65            | MA-0-MA          | Aluminium black   | Plastic black |                    | <b>704.403.010</b> | 7                   | 23 | 40 | 0.056             |                 |
|  |                  |                  | Aluminium natural | Plastic black |                    | <b>704.403.018</b> | 7                   | 23 | 40 | 0.056             |                 |
| Position C + B : Momentary action 42°<br>Position A : Basic position   | IP 65            | M-0-M            | Aluminium black   | Plastic black |                    | <b>704.405.010</b> | 7                   | 23 | 35 | 0.056             |                 |
|  |                  |                  | Aluminium natural | Plastic black |                    | <b>704.405.018</b> | 7                   | 23 | 35 | 0.056             |                 |

Switching action: MA = Maintained action, M = Momentary action

Mounting dimensions from page 91, Technical drawing from page 95, Circuit drawing from page 115

## Selector switch actuator 3 positions, long lever, flush mounting



### Essential Accessories:

Switching element page 51



|   | Front protection | Switching action | Frontbezel/-ring  | Lever         | ∅ 35 x 35 mm<br>Typ-Nr. | ∅ 35 mm<br>Typ-Nr. | Mounting dimensions | Technical drawing | Circuit drawing |       |
|---|------------------|------------------|-------------------|---------------|-------------------------|--------------------|---------------------|-------------------|-----------------|-------|
| <b>Selector switch actuator 3 positions, long lever, flush mounting</b><br>Position C : Maintained action 42°<br>Position A : Basic position<br>Position B : Momentary action 42° | IP 65            | MA-0-M           | Plastic black     | Plastic black | <b>704.296.000</b>      |                    | 13                  | 23                | 39              | 0.056 |
|   |                  |                  | Plastic silver    | Plastic black | <b>704.296.008</b>      |                    | 13                  | 23                | 39              | 0.056 |
| Position C : Momentary action 42°<br>Position A : Basic position<br>Position B : Maintained action 42°  | IP 65            | M-0-MA           | Plastic black     | Plastic black | <b>704.298.000</b>      |                    | 13                  | 16                | 36              | 0.056 |
|   |                  |                  | Plastic silver    | Plastic black | <b>704.298.008</b>      |                    | 13                  | 16                | 36              | 0.056 |
| Position C + B : Maintained action 42°<br>Position A : Basic position   | IP 65            | MA-0-MA          | Plastic black     | Plastic black | <b>704.292.000</b>      |                    | 13                  | 16                | 40              | 0.056 |
|   |                  |                  | Plastic silver    | Plastic black | <b>704.292.008</b>      |                    | 13                  | 16                | 40              | 0.056 |
| Position C + B : Momentary action 42°<br>Position A : Basic position  | IP 65            | M-0-M            | Plastic black     | Plastic black | <b>704.294.000</b>      |                    | 13                  | 16                | 35              | 0.056 |
|   |                  |                  | Plastic silver    | Plastic black | <b>704.294.008</b>      |                    | 13                  | 16                | 35              | 0.056 |
| Position C : Maintained action 42°<br>Position A : Basic position<br>Position B : Momentary action 42°  | IP 65            | MA-0-M           | Aluminium black   | Plastic black |                         | <b>704.097.010</b> | 8                   | 16                | 39              | 0.056 |
|   |                  |                  | Aluminium natural | Plastic black |                         | <b>704.097.018</b> | 8                   | 16                | 39              | 0.056 |
| Position C : Momentary action 42°<br>Position A : Basic position<br>Position B : Maintained action 42°  | IP 65            | M-0-MA           | Aluminium black   | Plastic black |                         | <b>704.099.010</b> | 8                   | 16                | 36              | 0.056 |
|   |                  |                  | Aluminium natural | Plastic black |                         | <b>704.099.018</b> | 8                   | 16                | 36              | 0.056 |
| Position C + B : Maintained action 42°<br>Position A : Basic position   | IP 65            | MA-0-MA          | Aluminium black   | Plastic black |                         | <b>704.093.010</b> | 8                   | 16                | 40              | 0.056 |
|   |                  |                  | Aluminium natural | Plastic black |                         | <b>704.093.018</b> | 8                   | 16                | 40              | 0.056 |
| Position C + B : Momentary action 42°<br>Position A : Basic position  | IP 65            | M-0-M            | Aluminium black   | Plastic black |                         | <b>704.095.010</b> | 8                   | 16                | 35              | 0.056 |
|   |                  |                  | Aluminium natural | Plastic black |                         | <b>704.095.018</b> | 8                   | 16                | 35              | 0.056 |

Switching action: MA = Maintained action, M = Momentary action

Mounting dimensions from page 91, Technical drawing from page 95, Circuit drawing from page 115

## Rotary selector switch actuator, short lever, flush mounting



### Essential Accessories:

-  Rotary selector switching element 30° page 55
-  Rotary selector switching element 45° page 55
-  Rotary selector switching element 60° page 56

|  | Front protection | Frontbezel/-ring  | Lever         | Ø 35 x 35 mm<br>Typ-Nr. | Ø 35 mm<br>Typ-Nr.   | Mounting dimensions | Technical drawing |       |
|--|------------------|-------------------|---------------|-------------------------|----------------------|---------------------|-------------------|-------|
| <b>Rotary selector switch actuator, short lever, flush mounting</b><br>Position 0 : nine o'clock | IP 65            | Plastic black     | Plastic black | <b>704.510.100KN</b>    |                      | 14                  | 71                | 0.056 |
|  |                  | Plastic silver    | Plastic black | <b>704.510.108KN</b>    |                      | 14                  | 71                | 0.056 |
|  |                  | Aluminium black   | Plastic black |                         | <b>704.411.110KN</b> | 1                   | 71                | 0.056 |
|  |                  | Aluminium natural | Plastic black |                         | <b>704.411.118KN</b> | 1                   | 71                | 0.056 |
| Position 0 : twelve o'clock  | IP 65            | Aluminium black   | Plastic black |                         | <b>704.411.010KN</b> | 1                   | 71                | 0.056 |

Mounting dimensions from page 91, Technical drawing from page 95

## Rotary selector switch actuator, long lever, flush mounting



### Essential Accessories:

-  Rotary selector switching element 30° page 55
-  Rotary selector switching element 45° page 55
-  Rotary selector switching element 60° page 56

|   | Front protection | Frontbezel/-ring  | Lever         | Ø 35 x 35 mm<br>Typ-Nr. | Ø 35 mm<br>Typ-Nr.   | Mounting dimensions | Technical drawing |       |
|---|------------------|-------------------|---------------|-------------------------|----------------------|---------------------|-------------------|-------|
| <b>Rotary selector switch actuator, long lever, flush mounting</b><br>Position 0 : nine o'clock | IP 65            | Plastic black     | Plastic black | <b>704.300.100KN</b>    |                      | 14                  | 72                | 0.056 |
|   |                  | Plastic silver    | Plastic black | <b>704.300.108KN</b>    |                      | 14                  | 72                | 0.056 |
|   |                  | Aluminium black   | Plastic black |                         | <b>704.101.110KN</b> | 1                   | 72                | 0.056 |
|   |                  | Aluminium natural | Plastic black |                         | <b>704.101.118KN</b> | 1                   | 72                | 0.056 |
| Position 0 : twelve o'clock   | IP 65            | Aluminium natural | Plastic black |                         | <b>704.101.018KN</b> | 1                   | 72                | 0.056 |

Mounting dimensions from page 91, Technical drawing from page 95

## Keylock rotary switch actuator, flush mounting



### Essential Accessories:

-  Rotary selector switching element 30° page 55
-  Rotary selector switching element 45° page 55
-  Rotary selector switching element 60° page 56

|  | Front protection | Front ring        | Key remove | Ø 35 mm<br>Typ-Nr.   | Mounting dimensions | Technical drawing |       |
|--|------------------|-------------------|------------|----------------------|---------------------|-------------------|-------|
| <b>Keylock rotary switch actuator, flush mounting</b><br>Position 0 : nine o'clock (standard)<br>Standard lock 251 | IP 65            | Aluminium natural | 9 o'clock  | <b>704.123.118KN</b> | 7                   | 73                | 0.120 |
| Position 0 : twelve o'clock (special)<br>Standard lock 251   | IP 65            | Aluminium natural | 12 o'clock | <b>704.123.018KN</b> | 7                   | 73                | 0.120 |

Mounting dimensions from page 91, Technical drawing from page 95

## Key insert switch actuator 2 positions, flush mounting



### Essential Accessories:

-  Switching element page 51

|   | Front protection | Switching action | Front ring      | Ø 38 mm<br>Typ-Nr.  | Mounting dimensions | Technical drawing |       |
|---|------------------|------------------|-----------------|---------------------|---------------------|-------------------|-------|
| <b>Key insert switch actuator 2 positions, flush mounting</b> | IP 67            | 0-MA90°          | Stainless-steel | <b>704.101.0x28</b> | 11                  | 1                 | 0.130 |
|   |                  | 0-M45°           | Stainless-steel | <b>704.103.0x28</b> | 11                  | 1                 | 0.130 |

In the Typ-Nr. "x" stands for not defined actuator.

Switching action: MA = Maintained action, M = Momentary action

Mounting dimensions from page 91, Technical drawing from page 95

## Key insert switch actuator 3 positions, flush mounting



### Essential Accessories:

 Switching element page 51

|   | Front protection | Front ring      | Switching action | Ø 38 mm<br>Typ-Nr.  | Mounting dimensions | Technical drawing |       |
|---|------------------|-----------------|------------------|---------------------|---------------------|-------------------|-------|
| <b>Key insert switch actuator 3 positions, flush mounting</b> | IP 67            | Stainless-steel | MA45°-0-MA45°    | <b>704.093.0x28</b> | 11                  | 1                 | 0.130 |
|   |                  |                 | MA45°-0-M45°     | <b>704.097.0x28</b> | 11                  | 1                 | 0.130 |
|   |                  |                 | M45°-0-MA45°     | <b>704.099.0x28</b> | 11                  | 1                 | 0.130 |
|   |                  |                 | M45°-0-M45°      | <b>704.095.0x28</b> | 11                  | 1                 | 0.130 |

In the Typ-Nr. "x" stands for not defined actuator.

Switching action: MA = Maintained action, M = Momentary action

Mounting dimensions from page 91, Technical drawing from page 95

## Key insert switch actuator 3 positions Conductor Switch, flush mounting



### Essential Accessories:

 Switching element page 51

|  | Front protection | Front ring      | Switching action | Ø 38 mm<br>Typ-Nr.  | Mounting dimensions | Technical drawing |       |
|--|------------------|-----------------|------------------|---------------------|---------------------|-------------------|-------|
| <b>Key insert switch actuator 3 positions Conductor Switch, flush mounting</b> | IP 67            | Stainless-steel | M45°-0-M45°      | <b>704.095.0T28</b> | 15                  | 56                | 0.190 |

Switching action: M = Momentary action

Mounting dimensions from page 91, Technical drawing from page 95



## Lever switch



|   | Front protection | Front ring        | Lever         | Switching action | Contacts    | Contact material | Ø 40 mm<br>Typ-Nr. |  |
|---|------------------|-------------------|---------------|------------------|-------------|------------------|--------------------|---|
| <b>Lever switch</b><br>Typ S41, Lever-Nr. 11, 1 Contact element | IP 54            | Aluminium natural | Plastic black | MA / M           | 1 NC / 1 NO | Ag               | <b>704.151.XXX</b> | 0.230   |
| Typ S42, Lever-Nr. 11, 1 Contact element                        | IP 54            | Aluminium natural | Plastic black | MA / M           | 1 NC / 1 NO | Ag               | <b>704.152.XXX</b> | 0.230   |
| Typ S43, Lever-Nr. 11, 1 Contact element                        | IP 54            | Aluminium natural | Plastic black | MA / M           | 1 NC / 1 NO | Ag               | <b>704.153.XXX</b> | 0.230   |
| Typ S44, Lever-Nr. 11, 1 Contact element<br>positive opened     | IP 54            | Aluminium natural | Plastic black | MA / M           | 1 NC / 1 NO | Ag               | <b>704.154.XXX</b> | 0.230   |
| Typ S45, Lever-Nr. 11, 1 Contact element<br>positive open       | IP 54            | Aluminium natural | Plastic black | MA / M           | 1 NC / 1 NO | Ag               | <b>704.155.XXX</b> | 0.230   |

### Connection types

S41: Cage clamp 1.0 ... 1.5 mm<sup>2</sup>

S42: JST connector max. 0.2 mm<sup>2</sup> (counter plug is supplied)

S43: Plug-in terminal 6.3 x 0.8 mm

S44: Cage clamp 1.0 ... 1.5 mm<sup>2</sup>

S45: Screw terminal or plug-in terminal 6.3 x 0.8 mm.

### Micro-switch contacts

The micro-switch is available with a silver contact or a gold plated silver contact.

Contact without positive opening operation:

This is used in the lever switches S41, S42 and S43. Each lever switch includes a maximum of 5 micro-switches.

Contact with positive opening operation:

This is used in the lever switches S44 and S45. Each lever switch includes a maximum of 4 micro-switches.

### Levers

There are 8 alternative standard levers (02, 03, 04, 05, 11, 13, 14, 15) available. Special levers are available on request.

### Front bezel

Standard front bezel in aluminium natural, can also be delivered in black version.

### Note:

Typ-Nr. will be supplied once switching function has been defined including specification of lever style and switching positions.

For further information please contact your local sales office.

A detailed technical documentation is available separately.

Switching action: MA = Maintained action, M = Momentary action

Contacts: NC = Normally closed, NO = Normally open

Contact material: Ag = Silver

## Front

### Legend frame

adhesive, Aluminium black

|   | Typ-Nr.          | Technical drawing |  |
|---|------------------|-------------------|---|
| <b>Legend frame</b><br>30 x 50 mm for raised mounting | <b>704.968.2</b> | 55                | 0.001   |
| 35 x 57.5 mm for flush mounting                       | <b>704.968.3</b> | 60                | 0.001   |



Technical drawing from page 95

### Legend plate insert

for Legend frame 704.968.2 and 704.968.3

|   | Typ-Nr.          |  |
|---|------------------|---|
| <b>Legend plate insert</b><br>14.5 x 23.5 mm, adhesive, Aluminium black | <b>704.968.1</b> | 0.001   |
| 14.5 x 23.5 mm, adhesive, Aluminium natural                             | <b>704.968.0</b> | 0.001   |



### Legend plate, square for flush mounting

|   | Typ-Nr.          |  |
|---|------------------|---|
| <b>Legend plate, square for flush mounting</b><br>18 x 35 mm, adhesive, Aluminium black | <b>704.968.5</b> | 0.001   |
| 18 x 35 mm, adhesive, Aluminium natural   | <b>704.968.4</b> | 0.001   |



### Protective cover

Mounting hole size 22.5 mm dia.

|  | Typ-Nr.          | Technical drawing |  |
|--|------------------|-------------------|---|
| <b>Protective cover</b><br>hinged, transparent, with means for sealing, for Pushbutton | <b>704.925.0</b> | 49                | 0.007   |
| hinged, transparent, with means for sealing, for Selector switch                       | <b>704.925.2</b> | 51                | 0.007   |
| hinged, transparent, with means for sealing, with spring fitted, for Pushbutton        | <b>704.925.3</b> | 49                | 0.007   |



Protective cover only for selector switch in basic position A applicable.

Technical drawing from page 95

## Protective cover, flush mounting

Mounting hole size 30.5 mm dia.

|  | Typ-Nr.           | Technical drawing |       |
|--|-------------------|-------------------|-------|
| <b>Protective cover, flush mounting</b><br>hinged, Aluminium natural, with means for sealing, for Pushbutton and Selector switch short lever | <b>704.928.38</b> | 53                | 0.019 |
| hinged, Aluminium natural, with means for sealing, spring fitted, for Pushbutton and Selector switch short lever                             | <b>704.928.28</b> | 50                | 0.019 |
| hinged, Aluminium natural, with window, spring fitted, for Pushbutton  | <b>704.928.18</b> | 52                | 0.019 |
| hinged, transparent, with means for sealing, for Pushbutton  | <b>704.925.7</b>  | 54                | 0.006 |

Technical drawing from page 95



## Blind plug

|  | Blind plug    | Typ-Nr.          | Technical drawing |       |
|--|---------------|------------------|-------------------|-------|
| <b>Blind plug</b><br>Size 28 mm dia., for mounting hole 22.5 mm dia. | Plastic black | <b>704.960.4</b> | 46                | 0.004 |
| Size 30 x 30 mm, for mounting hole 22.5 mm dia.                      | Plastic black | <b>704.964.7</b> | 43                | 0.009 |
| Size 35 x 35 mm, for mounting hole 30 x 30 mm                        | Plastic black | <b>704.964.9</b> | 45                | 0.009 |
| Size 36 mm dia., for mounting hole 30.5 mm dia.                      | Plastic black | <b>704.964.8</b> | 44                | 0.007 |

Technical drawing from page 95



## Spare key

|                                       | Typ-Nr.            |       |
|---------------------------------------|--------------------|-------|
| <b>Spare key</b><br>Standard lock 251 | <b>704.989.251</b> | 0.006 |

Other lock numbers on request



## Backside

### Flasher element



|  | Terminals | Typ-Nr.          | Technical drawing |                 |       |
|--|-----------|------------------|-------------------|-----------------|-------|
|  |           |                  | Technical drawing | Circuit drawing | kg    |
| <b>Flasher element</b><br>Operating voltage : 115 VAC ±10 %, 50/60 Hz<br>Lamp voltage/-current : 60 V, 33 mA | ST        | <b>704.943.1</b> | 32                | 12              | 0.024 |
| Operating voltage : 130 VDC ±10 %<br>Lamp voltage/-current : 130 V, 3 mA                                     | ST        | <b>704.943.2</b> | 32                | 12              | 0.024 |
| Operating voltage : 230 VAC -10 % ... +6 %, 50/60 Hz<br>Lamp voltage/-current : 130 V, 20 mA                 | ST        | <b>704.943.0</b> | 32                | 12              | 0.024 |
| Operating voltage : 24 VDC ±15 %<br>Lamp voltage/-current : 24 V, 10 mA ... 85 mA                            | ST        | <b>704.943.5</b> | 32                | 12              | 0.024 |

Further information in the Technical Data and Typical Applications

Terminals: ST = Screw terminal

Technical drawing from page 95, Circuit drawing from page 115

## Switching element

|                          | Switch rating | Switching system | Contacts      | Contact material | Terminals        | Typ-Nr.            | Technical drawing | Circuit drawing    |  |   |       |
|--------------------------|---------------|------------------|---------------|------------------|------------------|--------------------|-------------------|--------------------|---|---|-------|
| <b>Switching element</b> | 250 VAC, 6 A  | SA               | 1 NC          | Au-Ag            | PIT              | <b>704.907.2</b>   | 28                | 7                  | 0.020   |   |       |
|                          |               |                  |               | Ag-Cu            | PIT              | <b>704.908.2</b>   | 28                | 7                  | 0.020   |   |       |
|                          |               |                  | 1 NC + 1 NO   | Au-Ag            | PIT              | <b>704.907.5</b>   | 28                | 48                 | 0.027   |   |       |
|                          |               |                  |               | Ag-Cu            | PIT              | <b>704.908.5</b>   | 28                | 48                 | 0.027   |   |       |
|                          |               |                  | 1 NO          | Au-Ag            | PIT              | <b>704.907.1</b>   | 28                | 8                  | 0.020   |   |       |
|                          |               |                  |               | Ag-Cu            | PIT              | <b>704.908.1</b>   | 28                | 8                  | 0.020   |   |       |
|                          |               |                  | 2 NC          | Au-Ag            | PIT              | <b>704.907.4</b>   | 28                | 50                 | 0.027   |   |       |
|                          |               |                  |               | Ag-Cu            | PIT              | <b>704.908.4</b>   | 28                | 50                 | 0.027   |   |       |
|                          |               |                  | 2 NO          | Au-Ag            | PIT              | <b>704.907.3</b>   | 28                | 49                 | 0.027   |   |       |
|                          |               |                  |               | Ag-Cu            | PIT              | <b>704.908.3</b>   | 28                | 49                 | 0.027   |   |       |
|                          |               |                  | 500 VAC, 10 A | SM               | 1 NC             | Au-Ag              | ST                | <b>704.911.2</b>   | 29  | 7 | 0.021 |
|                          |               |                  |               |                  |                  | Ag-Cu              | D-PT 6.3          | <b>704.915.2/D</b> | 31  | 7 | 0.025 |
|                          | PT 6.3        | <b>704.915.2</b> |               |                  |                  |                    | 30                | 7                  | 0.021   |   |       |
|                          | ST            | <b>704.910.2</b> |               |                  |                  |                    | 29                | 7                  | 0.021   |   |       |
|                          | Ag-Pd         | ST               |               |                  | <b>704.912.2</b> | 29                 | 7                 | 0.021              |   |   |       |
|                          | 1 NC + 1 NO   | Au-Ag            |               |                  | ST               | <b>704.911.5</b>   | 29                | 48                 | 0.028   |   |       |
|                          |               | Ag-Cu            |               |                  | D-PT 6.3         | <b>704.915.5/D</b> | 31                | 48                 | 0.032   |   |       |
|                          |               |                  |               |                  | PT 6.3           | <b>704.915.5</b>   | 30                | 48                 | 0.028   |   |       |
|                          |               |                  |               |                  | ST               | <b>704.910.5</b>   | 29                | 48                 | 0.028   |   |       |
|                          | Ag-Pd         | ST               |               |                  | <b>704.912.5</b> | 29                 | 48                | 0.028              |   |   |       |
|                          | 1 NO          | Au-Ag            |               |                  | ST               | <b>704.911.1</b>   | 29                | 8                  | 0.021   |   |       |
|                          |               | Ag-Cu            |               |                  | D-PT 6.3         | <b>704.915.1/D</b> | 31                | 8                  | 0.025   |   |       |
|                          |               |                  |               |                  | PT 6.3           | <b>704.915.1</b>   | 30                | 8                  | 0.021   |   |       |
|                          |               |                  |               |                  | ST               | <b>704.910.1</b>   | 29                | 8                  | 0.021   |   |       |
|                          | Ag-Pd         | ST               |               |                  | <b>704.912.1</b> | 29                 | 8                 | 0.021              |   |   |       |
|                          | 2 NC          | Au-Ag            |               |                  | ST               | <b>704.911.4</b>   | 29                | 50                 | 0.028   |   |       |
|                          |               | Ag-Cu            |               |                  | D-PT 6.3         | <b>704.915.4/D</b> | 31                | 50                 | 0.032   |   |       |
|                          |               |                  |               |                  | PT 6.3           | <b>704.915.4</b>   | 30                | 50                 | 0.028   |   |       |
|                          |               |                  |               |                  | ST               | <b>704.910.4</b>   | 29                | 50                 | 0.028   |   |       |
|                          | Ag-Pd         | ST               |               |                  | <b>704.912.4</b> | 29                 | 50                | 0.028              |   |   |       |
|                          | 2 NO          | Au-Ag            |               |                  | ST               | <b>704.911.3</b>   | 29                | 49                 | 0.028   |   |       |
|                          |               | Ag-Cu            |               |                  | D-PT 6.3         | <b>704.915.3/D</b> | 31                | 49                 | 0.032   |   |       |
| PT 6.3                   |               |                  |               |                  | <b>704.915.3</b> | 30                 | 49                | 0.028              |   |   |       |
| ST                       |               |                  |               |                  | <b>704.910.3</b> | 29                 | 49                | 0.028              |   |   |       |
| Ag-Pd                    | ST            | <b>704.912.3</b> | 29            | 49               | 0.028            |                    |                   |                    |   |   |       |



Continuation see next page

Continued from previous page

|                          | Switch rating | Switching system | Contacts    | Contact material | Terminals | Typ-Nr.            | Technical drawing | Circuit drawing |  |
|--------------------------|---------------|------------------|-------------|------------------|-----------|--------------------|-------------------|-----------------|---|
| <b>Switching element</b> | 500 VAC, 10 A | SA               | 1 NC        | Au-Ag            | D-PT 6.3  | <b>704.901.2/D</b> | 31                | 7               | 0.026   |
|                          |               |                  |             |                  | ST        | <b>704.901.2</b>   | 29                | 7               | 0.021   |
|                          |               |                  |             | Ag-Cu            | D-PT 6.3  | <b>704.905.2/D</b> | 31                | 7               | 0.026   |
|                          |               |                  |             |                  | PT 6.3    | <b>704.905.2</b>   | 30                | 7               | 0.021   |
|                          |               |                  |             | Ag-Pd            | ST        | <b>704.900.2</b>   | 29                | 7               | 0.021   |
|                          |               |                  |             |                  | ST        | <b>704.902.2</b>   | 29                | 7               | 0.021   |
|                          |               |                  | 1 NC + 1 NO | Au-Ag            | D-PT 6.3  | <b>704.901.5/D</b> | 31                | 48              | 0.033   |
|                          |               |                  |             |                  | ST        | <b>704.901.5</b>   | 29                | 48              | 0.028   |
|                          |               |                  |             | Ag-Cu            | D-PT 6.3  | <b>704.905.5/D</b> | 31                | 48              | 0.033   |
|                          |               |                  |             |                  | PT 6.3    | <b>704.905.5</b>   | 30                | 48              | 0.028   |
|                          |               |                  |             | Ag-Pd            | ST        | <b>704.900.5</b>   | 29                | 48              | 0.028   |
|                          |               |                  |             |                  | ST        | <b>704.902.5</b>   | 29                | 48              | 0.028   |
|                          |               |                  | 1 NO        | Au-Ag            | D-PT 6.3  | <b>704.901.1/D</b> | 31                | 8               | 0.026   |
|                          |               |                  |             |                  | ST        | <b>704.901.1</b>   | 29                | 8               | 0.021   |
|                          |               |                  |             | Ag-Cu            | D-PT 6.3  | <b>704.905.1/D</b> | 31                | 8               | 0.026   |
|                          |               |                  |             |                  | PT 6.3    | <b>704.905.1</b>   | 30                | 8               | 0.021   |
|                          |               |                  |             | Ag-Pd            | ST        | <b>704.900.1</b>   | 29                | 8               | 0.021   |
|                          |               |                  |             |                  | ST        | <b>704.902.1</b>   | 29                | 8               | 0.021   |
|                          |               |                  | 2 NC        | Au-Ag            | D-PT 6.3  | <b>704.901.4/D</b> | 31                | 50              | 0.033   |
|                          |               |                  |             |                  | ST        | <b>704.901.4</b>   | 29                | 50              | 0.028   |
|                          |               |                  |             | Ag-Cu            | D-PT 6.3  | <b>704.905.4/D</b> | 31                | 50              | 0.033   |
|                          |               |                  |             |                  | PT 6.3    | <b>704.905.4</b>   | 30                | 50              | 0.028   |
|                          |               |                  |             | Ag-Pd            | ST        | <b>704.900.4</b>   | 29                | 50              | 0.028   |
|                          |               |                  |             |                  | ST        | <b>704.902.4</b>   | 29                | 50              | 0.028   |
|                          |               |                  | 2 NO        | Au-Ag            | D-PT 6.3  | <b>704.901.3/D</b> | 31                | 49              | 0.033   |
|                          |               |                  |             |                  | ST        | <b>704.901.3</b>   | 29                | 49              | 0.028   |
|                          |               |                  |             | Ag-Cu            | D-PT 6.3  | <b>704.905.3/D</b> | 31                | 49              | 0.033   |
|                          |               |                  |             |                  | PT 6.3    | <b>704.905.3</b>   | 30                | 49              | 0.028   |
|                          |               |                  |             | Ag-Pd            | ST        | <b>704.900.3</b>   | 29                | 49              | 0.028   |
|                          |               |                  |             |                  | ST        | <b>704.902.3</b>   | 29                | 49              | 0.028   |

For the 3rd switching element per switch the terminal marking insert is to be ordered separately.

Switching system: SA = Snap-action switching element, SM = Slow-make switching element

Contacts: NC = Normally closed, NO = Normally open

Contact material: Au-Ag = Gold-Silver, Ag-Cu = Hard silver, Ag-Pd = Silver-Palladium

Terminals: PIT = PIT Spring terminal, ST = Screw terminal, D-PT 6.3 = Double plug-in terminal 6.3 mm, PT 6.3 = Plug-in terminal 6.3 mm

Technical drawing from page 95, Circuit drawing from page 115

## Switching element for ring cable shoe



|  | Switching system | Contacts    | Contact material | Terminals         | Typ-Nr.           | Technical drawing | Circuit drawing |  |       |
|--|------------------|-------------|------------------|-------------------|-------------------|-------------------|-----------------|---|-------|
| <b>Switching element for ring cable shoe</b> | SM               | 1 NC        | Au-Ag            | ST                | <b>704.911.2B</b> | 29                | 7               | 0.021   |       |
|  |                  |             | Ag-Cu            | ST                | <b>704.910.2B</b> | 29                | 7               | 0.021   |       |
|  |                  | 1 NC + 1 NO | Au-Ag            | ST                | <b>704.911.5B</b> | 29                | 48              | 0.028   |       |
|  |                  |             | Ag-Cu            | ST                | <b>704.910.5B</b> | 29                | 48              | 0.028   |       |
|  |                  | 1 NO        | Au-Ag            | ST                | <b>704.911.1B</b> | 29                | 8               | 0.021   |       |
|  |                  |             | Ag-Cu            | ST                | <b>704.910.1B</b> | 29                | 8               | 0.021   |       |
|  |                  | 2 NC        | Au-Ag            | ST                | <b>704.911.4B</b> | 29                | 50              | 0.028   |       |
|  |                  |             | Ag-Cu            | ST                | <b>704.910.4B</b> | 29                | 50              | 0.028   |       |
|  |                  | 2 NO        | Au-Ag            | ST                | <b>704.911.3B</b> | 29                | 49              | 0.028   |       |
|  |                  |             | Ag-Cu            | ST                | <b>704.910.3B</b> | 29                | 49              | 0.028   |       |
|  |                  | SA          | 1 NC             | Ag-Cu             | ST                | <b>704.900.2B</b> | 29              | 7   | 0.021 |
|  |                  |             | 1 NC + 1 NO      | Ag-Cu             | ST                | <b>704.900.5B</b> | 29              | 48  | 0.028 |
|  | 1 NO             |             | Ag-Cu            | ST                | <b>704.900.1B</b> | 29                | 8               | 0.021   |       |
|  | 2 NC             |             | Ag-Cu            | ST                | <b>704.900.4B</b> | 29                | 50              | 0.028   |       |
| 2 NO   | Ag-Cu            |             | ST               | <b>704.900.3B</b> | 29                | 49                | 0.028           |   |       |

Switching system: SM = Slow-make switching element, SA = Snap-action switching element

Contacts: NC = Normally closed, NO = Normally open

Contact material: Au-Ag = Gold-Silver, Ag-Cu = Hard silver

Terminals: ST = Screw terminal

Technical drawing from page 95, Circuit drawing from page 115

## Switching element for Emergency-stop pushbutton

|  | Switch rating | Switching system | Contacts           | Contact material | Terminals        | Typ-Nr.            | Technical drawing |                    | kg    |   |       |
|--|---------------|------------------|--------------------|------------------|------------------|--------------------|-------------------|--------------------|-------|---|-------|
|  |               |                  |                    |                  |                  |                    |                   |                    |       |   |       |
| <b>Switching element for Emergency-stop pushbutton</b> | 250 VAC, 6 A  | SM               | 1 NC               | Au-Ag            | PIT              | <b>704.917.2</b>   | 28                | 7                  | 0.019 |   |       |
|  |               |                  |                    | Ag-Cu            | PIT              | <b>704.918.2</b>   | 28                | 7                  | 0.019 |   |       |
|  |               |                  | 1 NC + 1 NO        | Au-Ag            | PIT              | <b>704.917.5</b>   | 28                | 48                 | 0.026 |   |       |
|  |               |                  |                    | Ag-Cu            | PIT              | <b>704.918.5</b>   | 28                | 48                 | 0.026 |   |       |
|  |               |                  | 1 NO               | Au-Ag            | PIT              | <b>704.917.1</b>   | 28                | 8                  | 0.019 |   |       |
|  |               |                  |                    | Ag-Cu            | PIT              | <b>704.918.1</b>   | 28                | 8                  | 0.019 |   |       |
|  |               |                  | 2 NC               | Au-Ag            | PIT              | <b>704.917.4</b>   | 28                | 50                 | 0.019 |   |       |
|  |               |                  |                    | Ag-Cu            | PIT              | <b>704.918.4</b>   | 28                | 50                 | 0.019 |   |       |
|  |               |                  | 2 NO               | Au-Ag            | PIT              | <b>704.917.3</b>   | 28                | 49                 | 0.026 |   |       |
|  |               |                  |                    | Ag-Cu            | PIT              | <b>704.918.3</b>   | 28                | 49                 | 0.026 |   |       |
|  |               |                  | 500 VAC, 10 A      | SM               | 1 NC             | Au-Ag              | ST                | <b>704.911.2</b>   | 29    | 7 | 0.021 |
|  |               |                  |                    |                  |                  | Ag-Cu              | D-PT 6.3          | <b>704.915.2/D</b> | 31    | 7 | 0.025 |
|  | PT 6.3        | <b>704.915.2</b> |                    |                  |                  |                    | 30                | 7                  | 0.021 |   |       |
|  | ST            | <b>704.910.2</b> |                    |                  |                  |                    | 29                | 7                  | 0.021 |   |       |
|  | Ag-Pd         | ST               |                    |                  | <b>704.912.2</b> | 29                 | 7                 | 0.021              |       |   |       |
|  | 1 NC + 1 NO   | Au-Ag            |                    |                  | ST               | <b>704.911.5</b>   | 29                | 48                 | 0.028 |   |       |
|  |               | Ag-Cu            |                    |                  | D-PT 6.3         | <b>704.915.5/D</b> | 31                | 48                 | 0.032 |   |       |
|  |               |                  |                    |                  | PT 6.3           | <b>704.915.5</b>   | 30                | 48                 | 0.028 |   |       |
|  |               |                  |                    |                  | ST               | <b>704.910.5</b>   | 29                | 48                 | 0.028 |   |       |
|  | Ag-Pd         | ST               |                    |                  | <b>704.912.5</b> | 29                 | 48                | 0.028              |       |   |       |
|  | 1 NO          | Au-Ag            |                    |                  | ST               | <b>704.911.1</b>   | 29                | 8                  | 0.021 |   |       |
|  |               | Ag-Cu            |                    |                  | D-PT 6.3         | <b>704.915.1/D</b> | 31                | 8                  | 0.025 |   |       |
|  |               |                  | PT 6.3             | <b>704.915.1</b> | 30               | 8                  | 0.021             |                    |       |   |       |
|  |               |                  | ST                 | <b>704.910.1</b> | 29               | 8                  | 0.021             |                    |       |   |       |
| Ag-Pd  | ST            | <b>704.912.1</b> | 29                 | 8                | 0.021            |                    |                   |                    |       |   |       |
| 2 NC   | Au-Ag         | ST               | <b>704.911.4</b>   | 29               | 50               | 0.028              |                   |                    |       |   |       |
|  | Ag-Cu         | D-PT 6.3         | <b>704.915.4/D</b> | 31               | 50               | 0.032              |                   |                    |       |   |       |
|  |               | PT 6.3           | <b>704.915.4</b>   | 30               | 50               | 0.028              |                   |                    |       |   |       |
|  |               | ST               | <b>704.910.4</b>   | 29               | 50               | 0.028              |                   |                    |       |   |       |
| Ag-Pd  | ST            | <b>704.912.4</b> | 29                 | 50               | 0.028            |                    |                   |                    |       |   |       |
| 2 NO   | Au-Ag         | ST               | <b>704.911.3</b>   | 29               | 49               | 0.028              |                   |                    |       |   |       |
|  | Ag-Cu         | D-PT 6.3         | <b>704.915.3/D</b> | 31               | 49               | 0.032              |                   |                    |       |   |       |
|  |               | PT 6.3           | <b>704.915.3</b>   | 30               | 49               | 0.028              |                   |                    |       |   |       |
|  |               | ST               | <b>704.910.3</b>   | 29               | 49               | 0.028              |                   |                    |       |   |       |
| Ag-Pd  | ST            | <b>704.912.3</b> | 29                 | 49               | 0.028            |                    |                   |                    |       |   |       |



Switching system: SM = Slow-make switching element

Contacts: NC = Normally closed, NO = Normally open

Contact material: Au-Ag = Gold-Silver, Ag-Cu = Hard silver, Ag-Pd = Silver-Palladium

Terminals: PIT = PIT Spring terminal, ST = Screw terminal, D-PT 6.3 = Double plug-in terminal 6.3 mm, PT 6.3 = Plug-in terminal 6.3 mm

Technical drawing from page 95, Circuit drawing from page 115



## Rotary selector switching element 30°

|  | Contacts    | Stages | Terminals | Typ-Nr.          | Circuit drawing |       |
|--|-------------|--------|-----------|------------------|-----------------|-------|
| <b>Rotary selector switching element 30°</b><br>Position a : Start position<br>Position i : End position | 9 (1-pole)  | 5      | ST        | <b>704.8A236</b> | 13              | 0.073 |
| Position a : Start position<br>Position k : End position   | 10 (1-pole) | 5      | ST        | <b>704.8A237</b> | 14              | 0.073 |
| Position a : Start position<br>Position l : End position   | 11 (1-pole) | 6      | ST        | <b>704.8A238</b> | 15              | 0.082 |
| Position a : Start position<br>Position m : End position   | 12 (1-pole) | 6      | ST        | <b>704.8A239</b> | 16              | 0.082 |
| Position a : Start position<br>without stop  | 12 (1-pole) | 6      | ST        | <b>704.8A639</b> | 16              | 0.082 |



Rotary switching elements are not on stock and have to be ordered as a customised product locally

Terminals: ST = Screw terminal

Circuit drawing from page 115

## Rotary selector switching element 45°

|  | Contacts    | Stages | Terminals | Typ-Nr.          | Circuit drawing |       |
|--|-------------|--------|-----------|------------------|-----------------|-------|
| <b>Rotary selector switching element 45°</b><br>Position a : Start position<br>Position g : End position | 7 (1-pole)  | 4      | ST        | <b>704.8A234</b> | 17              | 0.064 |
|  | 7 (2-poles) | 7      | ST        | <b>704.8A254</b> | 18              | 0.091 |
| Position a : Start position<br>Position h : End position   | 8 (1-pole)  | 4      | ST        | <b>704.8A235</b> | 19              | 0.064 |
|  | 8 (2-poles) | 8      | ST        | <b>704.8A255</b> | 20              | 0.100 |



Rotary switching elements are not on stock and have to be ordered as a customised product locally

Terminals: ST = Screw terminal

Circuit drawing from page 115

## Rotary selector switching element 60°

|  | Contacts                | Stages | Terminals | Typ-Nr.          | Circuit drawing |  |
|--|-------------------------|--------|-----------|------------------|-----------------|---|
| <b>Rotary selector switching element 60°</b><br>Position a : Start position<br>Position c : End position | 3 (1-pole)              | 2      | ST        | <b>704.8A230</b> | 21              | 0.046   |
|  | 3 (1-pole, DC-isolated) | 2      | ST        | <b>704.8A730</b> | 32              | 0.046   |
|  | 3 (2-poles)             | 3      | ST        | <b>704.8A250</b> | 22              | 0.055   |
|  | 3 (3-poles)             | 5      | ST        | <b>704.8A270</b> | 23              | 0.073   |
| Position a : Start position<br>Position d : End position   | 4 (1-pole)              | 2      | ST        | <b>704.8A231</b> | 24              | 0.046   |
|  | 4 (1-pole, DC isolated) | 2      | ST        | <b>704.8A731</b> | 33              | 0.046   |
|  | 4 (2-poles)             | 4      | ST        | <b>704.8A251</b> | 25              | 0.064   |
|  | 4 (3-poles)             | 6      | ST        | <b>704.8A271</b> | 26              | 0.082   |
| Position a : Start position<br>Position e : End position   | 5 (1-pole)              | 3      | ST        | <b>704.8A232</b> | 27              | 0.055   |
|  | 5 (2-poles)             | 5      | ST        | <b>704.8A252</b> | 28              | 0.073   |
|  | 5 (3-poles)             | 8      | ST        | <b>704.8A272</b> | 29              | 0.100   |
| Position a : Start position<br>Position f : End position   | 6 (1-pole)              | 3      | ST        | <b>704.8A233</b> | 30              | 0.055   |
|  | 6 (2-poles)             | 6      | ST        | <b>704.8A253</b> | 31              | 0.082   |



Rotary switching elements are not on stock and have to be ordered as a customised product locally

Terminals: ST = Screw terminal

Circuit drawing from page 115

## Terminal cover

|   | Typ-Nr.          | Technical drawing |  |
|---|------------------|-------------------|---|
| <b>Terminal cover</b><br>for covering of screw terminal | <b>704.964.5</b> | 35                | 0.003   |



Technical drawing from page 95

## Terminal marking

|   | Marking     | Typ-Nr.          |  |
|---|-------------|------------------|---|
| <b>Terminal marking</b><br>1 NC + 1 NO (for 1st or 2nd switching element) | 13/21 33/41 | <b>704.965.9</b> | 0.001   |
|   | 22/14 42/34 | <b>704.966.0</b> | 0.001   |
| 1 NC + 1 NO (for 3rd switching element)                                   | 53/61 73/81 | <b>704.966.1</b> | 0.001   |
|   | 62/54 82/74 | <b>704.966.2</b> | 0.001   |
| 2 NC (for 1st or 2nd switching element)                                   | 11/21 31/41 | <b>704.965.5</b> | 0.001   |
|   | 22/12 42/32 | <b>704.965.6</b> | 0.001   |
| 2 NC (for 3rd switching element)  | 51/61 71/81 | <b>704.965.7</b> | 0.001   |
|   | 62/52 82/72 | <b>704.965.8</b> | 0.001   |
| 2 NO (for 1st or 2nd switching element)                                   | 13/23 33/43 | <b>704.965.1</b> | 0.001   |
|   | 24/14 44/34 | <b>704.965.2</b> | 0.001   |
| 2 NO (for 3rd switching element)  | 53/63 73/83 | <b>704.965.3</b> | 0.001   |
|   | 64/54 84/74 | <b>704.965.4</b> | 0.001   |



## Illumination

### Filament lamp

The max. overall length of the lamp may not exceed 25 mm

| Filament lamp | Socket | Operating voltage/-current | Typ-Nr.             |  kg |
|---------------|--------|----------------------------|---------------------|--|
| Filament lamp | BA9s   | 110 VAC/DC, 22 mA          | <b>10-1422.1179</b> | 0.002  |
|               |        | 12 VAC/DC, 100 mA          | <b>10-1409.1329</b> | 0.002  |
|               |        | 130 VAC/DC, 20 mA          | <b>10-1424.1179</b> | 0.002  |
|               |        | 24 VAC/DC, 50 mA           | <b>10-1412.1279</b> | 0.002  |
|               |        | 36 VAC/DC, 56 mA           | <b>10-1416.1289</b> | 0.002  |
|               |        | 48 VAC/DC, 42 mA           | <b>10-1419.1249</b> | 0.002  |
|               |        | 6 VAC/DC, 200 mA           | <b>10-1406.1369</b> | 0.002  |
|               |        | 60 VAC/DC, 33 mA           | <b>10-1420.1219</b> | 0.002  |



## Single-LED

The max. overall length of the lamp may not exceed 25 mm

| Single-LED | Socket | Light colour  | Operating voltage/-current | Typ-Nr.      | kg    |
|------------|--------|---------------|----------------------------|--------------|-------|
| Single-LED | BA9s   | blue          | 12 VAC/DC, 16 mA           | 10-2509.1146 | 0.002 |
|            |        |               | 130 VAC, 5 mA              | 10-2H24.2056 | 0.002 |
|            |        |               | 230 VAC, 3 mA              | 10-2H25.2046 | 0.002 |
|            |        |               | 24 VAC/DC, 15 mA           | 10-2512.1146 | 0.002 |
|            |        |               | 28 VAC/DC, 13 mA           | 10-2513.1146 | 0.002 |
|            |        |               | 48 VAC/DC, 8 mA            | 10-2519.1056 | 0.002 |
|            |        | 6 VDC, 17 mA  | 10-2506.1086               | 0.002        |       |
|            |        | green         | 12 VAC/DC, 7 mA            | 10-2509.1145 | 0.002 |
|            |        |               | 130 VAC, 3 mA              | 10-2H24.2055 | 0.002 |
|            |        |               | 230 VAC, 2 mA              | 10-2H25.2045 | 0.002 |
|            |        |               | 24 VAC/DC, 7 mA            | 10-2512.1145 | 0.002 |
|            |        |               | 28 VAC/DC, 7 mA            | 10-2513.1145 | 0.002 |
|            |        |               | 48 VAC/DC, 4 mA            | 10-2519.1055 | 0.002 |
|            |        | 6 VDC, 7 mA   | 10-2506.1085               | 0.002        |       |
|            |        | red           | 12 VAC/DC, 16 mA           | 10-2509.1142 | 0.002 |
|            |        |               | 130 VAC, 5 mA              | 10-2H24.2052 | 0.002 |
|            |        |               | 230 VAC, 3 mA              | 10-2H25.2042 | 0.002 |
|            |        |               | 24 VAC/DC, 15 mA           | 10-2512.1142 | 0.002 |
|            |        |               | 28 VAC/DC, 13 mA           | 10-2513.1142 | 0.002 |
|            |        |               | 48 VAC/DC, 8 mA            | 10-2519.1052 | 0.002 |
|            |        | 6 VDC, 17 mA  | 10-2506.1082               | 0.002        |       |
|            |        | white diffuse | 12 VAC/DC, 16 mA           | 10-2509.1149 | 0.002 |
|            |        |               | 130 VAC, 5 mA              | 10-2H24.2059 | 0.002 |
|            |        |               | 230 VAC, 3 mA              | 10-2H25.2049 | 0.002 |
|            |        |               | 24 VAC/DC, 15 mA           | 10-2512.1149 | 0.002 |
|            |        |               | 28 VAC/DC, 13 mA           | 10-2513.1149 | 0.002 |
|            |        |               | 48 VAC/DC, 8 mA            | 10-2519.1059 | 0.002 |
|            |        | 6 VDC, 17 mA  | 10-2506.1089               | 0.002        |       |
|            |        | yellow        | 12 VAC/DC, 16 mA           | 10-2509.1144 | 0.002 |
|            |        |               | 130 VAC, 5 mA              | 10-2H24.2054 | 0.002 |
|            |        |               | 230 VAC, 3 mA              | 10-2H25.2044 | 0.002 |
|            |        |               | 24 VAC/DC, 15 mA           | 10-2512.1144 | 0.002 |
|            |        |               | 28 VAC/DC, 13 mA           | 10-2513.1144 | 0.002 |
|            |        |               | 48 VAC/DC, 8 mA            | 10-2519.1054 | 0.002 |
|            |        | 6 VDC, 17 mA  | 10-2506.1084               | 0.002        |       |



Note:

AC operation through halve-wave rectifier possible, slight flickering can occur.

12, 24, 28, 48 VAC/DC versions with bridge rectifier. Used on a DC voltage and AC voltage with the same light output.

## Diode block

| Diode block     | Terminals | Typ-Nr.   | Technical drawing | Circuit drawing | kg    |
|-----------------|-----------|-----------|-------------------|-----------------|-------|
| 2 Diodes 1N4007 | ST        | 704.942.5 | 34                | 2               | 0.019 |



Terminals: ST = Screw terminal

Technical drawing from page 95, Circuit drawing from page 115

## Lamp transformer

Lamp voltage/-current : 24 VAC, 50 mA, 50/60 Hz

|   | Terminals | Typ-Nr.          | Technical drawing | Circuit drawing |  |
|---|-----------|------------------|-------------------|-----------------|---|
| <b>Lamp transformer</b><br>Operating voltage : 115 VAC / 24 VAC | ST        | <b>704.970.3</b> | 33                | 9               | 0.100   |
| Operating voltage : 230 VAC / 24 VAC                            | ST        | <b>704.970.4</b> | 33                | 9               | 0.100   |
| Operating voltage : 400 VAC / 24 VAC                            | ST        | <b>704.970.5</b> | 33                | 9               | 0.100   |
| Operating voltage : 440 VAC / 24 VAC                            | ST        | <b>704.970.6</b> | 33                | 9               | 0.100   |



Terminals: ST = Screw terminal

Technical drawing from page 95, Circuit drawing from page 115

## Resistor block

Lamp voltage/-current : 130 V, 20mA und 60 V, 33 mA

|   | Terminals | Typ-Nr.          | Technical drawing | Circuit drawing |  |
|---|-----------|------------------|-------------------|-----------------|--|
| <b>Resistor block</b><br>Operating voltage : 125 VAC / 60 VAC | ST        | <b>704.941.5</b> | 34                | 10              | 0.006  |
| Operating voltage : 230 VAC / 130 VAC                         | ST        | <b>704.941.0</b> | 34                | 10              | 0.017  |



Terminals: ST = Screw terminal

Technical drawing from page 95, Circuit drawing from page 115

## Resistor-diode block

Lamp voltage/-current : 130 V, 20mA

|  | Terminals | Typ-Nr.          | Technical drawing | Circuit drawing |  |
|--|-----------|------------------|-------------------|-----------------|---|
| <b>Resistor-diode block</b><br>Operating voltage : 230 VAC / 130 VAC | ST        | <b>704.941.9</b> | 34                | 11              | 0.017   |



Terminals: ST = Screw terminal

Technical drawing from page 95, Circuit drawing from page 115

## Terminal plate empty

for fitting with series resistors

|   | Typ-Nr.         |  |
|---|-----------------|---|
| <b>Terminal plate empty</b><br>10 spaces 125 x 60 x 15 mm | <b>02-912.2</b> | 0.045   |
| 15 spaces 187.5 x 60 x 15 mm                              | <b>02-912.3</b> | 0.090   |
| 20 spaces 250 x 60 x 15 mm                                | <b>02-912.4</b> | 0.095   |
| 5 spaces 62.5 x 60 x 15 mm                                | <b>02-912.1</b> | 0.025   |



## Emergency-stop pushbutton

### Emergency-stop label

front panel thickness 3 mm max.

|  | Marking         | Typ-Nr.          |  |
|--|-----------------|------------------|---|
| <b>Emergency-stop label</b><br>60 mm dia., yellow, Mounting hole size 22.5 mm dia. | ARRET D'URGENCE | <b>704.963.7</b> | 0.011   |
|  | EMERGENCY STOP  | <b>704.963.6</b> | 0.011   |
|  | NOT AUS         | <b>704.963.5</b> | 0.011   |
|  | NOT HALT        | <b>704.963.8</b> | 0.011   |
| 90 mm dia., yellow, Mounting hole size 22.5 mm dia.                                | ARRET D'URGENCE | <b>704.963.2</b> | 0.011   |
|  | EMERGENCY STOP  | <b>704.963.1</b> | 0.011   |
|  | NOT AUS         | <b>704.963.0</b> | 0.011   |
|  | NOT HALT        | <b>704.963.3</b> | 0.011   |



### Emergency-stop protective shroud

use only for Typ-Nr. 704.064.2 und 704.066.2

|  | Typ-Nr.          | Technical drawing |  |
|--|------------------|-------------------|---|
| <b>Emergency-stop protective shroud</b><br>Plastic yellow, 50 mm dia., IP 65 | <b>704.927.8</b> | 58                | 0.024   |
| Plastic yellow, 50 mm dia., IP 65, SEMI S2-93/12.4.c                         | <b>704.927.9</b> | 59                | 0.052   |



The protection ring is not suitable for a proper use of Emergency-stop pushbutton. It can obstruct a spontaneous operation of the Emergency-stop pushbutton.

Technical drawing from page 95

### Emergency-stop enclosures

Bottom grey similar RAL 7035; cover lead-sealable, yellow similar RAL 1004

|  | Dimension                 | Typ-Nr.          | Technical drawing |  |
|--|---------------------------|------------------|-------------------|---|
| <b>Emergency-stop enclosures</b><br>with mounting hole size 22.5 mm dia., with anti-twist device | L 65 mm, W 65 mm, H 81 mm | <b>704.945.7</b> | 61                | 0.127   |
|  | L 94 mm, W 65 mm, H 81 mm | <b>704.945.8</b> | 62                | 0.157   |
|  | L 94 mm, W 94 mm, H 81 mm | <b>704.945.0</b> | 63                | 0.195   |



Openings for cable gland M16 or M20.

Protection class IP 66.

Technical drawing from page 95

## Cable gland

|   | Typ-Nr.          |  |
|---|------------------|---|
| <b>Cable gland</b><br>M16, Plastic grey | <b>61-9481.6</b> | 0.007   |
| M20, Plastic grey                       | <b>704.945.6</b> | 0.011   |



with traction relief; protection degree IP 68.

## Assembling

### Anti-twist ring, flush mounting

|  | Typ-Nr.          |  |
|--|------------------|---|
| <b>Anti-twist ring, flush mounting</b> | <b>704.954.0</b> | 0.002   |



### Reducing ring

Devices 22.5 mm dia. in mounting hole size 30.5 mm dia.

|   | Typ-Nr.          | Technical drawing |  |
|---|------------------|-------------------|---|
| <b>Reducing ring</b><br>Aluminium black | <b>704.960.0</b> | 57                | 0.004   |
| Aluminium natural                       | <b>704.960.8</b> | 57                | 0.004   |



With the metal bayonet flange you can use one reduction ring. If you have a plastic bayonet flange you need to install two reduction rings.

Technical drawing from page 95

### Mounting plate

for separate mounting of lamp transformer, resistor block or capacitor block

|                       | Typ-Nr.          | Technical drawing |  |
|-----------------------|------------------|-------------------|---|
| <b>Mounting plate</b> | <b>704.940.8</b> | 36                | 0.006   |



Technical drawing from page 95

## Snap-on base

to snap-on, for separate mounting of lamp transformer, resistor block or capacitor block

|  | Typ-Nr.          | Technical drawing |  kg |
|--|------------------|-------------------|--|
| <b>Snap-on base</b><br>DIN mounting bar EN 50022 | <b>704.941.1</b> | 38                | 0.006  |
| DIN mounting bar EN 50035                        | <b>704.940.9</b> | 37                | 0.006  |



Technical drawing from page 95

## Reinforcement plate

for thin front panel and plastic case

|  | Typ-Nr.          |  kg |
|--|------------------|--|
| <b>Reinforcement plate</b><br>44 x 29 x 2 mm, mounting hole 22,5 mm dia., sheet steel galvanized yellow passivated | <b>704.960.9</b> | 0.014  |



## Lens plug for round lens, flush mounting

with lamp remover function (BA9s)

|   | Typ-Nr.          |  kg |
|---|------------------|---|
| <b>Lens plug for round lens, flush mounting</b><br>for mounting and dismantling of Lens round, flush mounting | <b>700.006.0</b> | 0.003   |



## Lens remover for square lens, flush mounting

|   | Typ-Nr.       |  kg |
|---|---------------|--|
| <b>Lens remover for square lens, flush mounting</b> | <b>98-968</b> | 0.004  |



## Mounting tool for Indicator

for Indicators full-face illumination, compact

|   | Typ-Nr.          |  kg |
|---|------------------|--|
| <b>Mounting tool for Indicator</b><br>for tightening (or loosening) of the Fixing nut | <b>700.005.0</b> | 0.020  |



## Mounting tool for Key insert switch

|   | Typ-Nr.          |  kg |
|---|------------------|--|
| <b>Mounting tool for Key insert switch</b><br>for tightening (or loosening) of the Fixing nut | <b>704.990.0</b> | 0.020  |





## Enclosure

Grey similar RAL 7035; cover lead-sealable

|   | Dimension                    | Typ-Nr.          | Technical drawing |  |
|---|------------------------------|------------------|-------------------|---|
| <b>Enclosure</b><br>with mounting hole 1 x 22.5 mm dia., with anti-twist device | L 94 mm, W 94 mm, H 81 mm    | <b>704.945.1</b> | 63                | 0.211   |
| with mounting hole 2 x 22.5 mm dia., with anti-twist device                     | L 130 mm, W 94 mm, H 81 mm   | <b>704.945.2</b> | 64                | 0.251   |
| with mounting hole 3 x 22.5 mm dia., with anti-twist device                     | L 180 mm, W 94 mm, H 81 mm   | <b>704.945.3</b> | 65                | 0.313   |
| with mounting hole 4 x 22.5 mm dia., with anti-twist device                     | L 180 mm, W 182 mm, H 110 mm | <b>704.945.4</b> | 66                | 0.572   |
| with mounting hole 6 x 22.5 mm dia., with anti-twist device                     | L 180 mm, W 182 mm, H 110 mm | <b>704.945.5</b> | 67                | 0.568   |



Openings for cable gland M16 or M20.

Protection class IP 66.

Technical drawing from page 95

## Cable gland

|   | Typ-Nr.          |  |
|---|------------------|---|
| <b>Cable gland</b><br>M16, Plastic grey | <b>61-9481.6</b> | 0.007   |
| M20, Plastic grey                       | <b>704.945.6</b> | 0.011   |



with traction relief; protection degree IP 68.

## Indicator compact

## Indicator actuator for Indicator compact

|   | Housing      | Ø 29 mm<br>Typ-Nr. | Circuit drawing |  |
|---|--------------|--------------------|-----------------|---|
| <b>Indicator actuator for Indicator compact</b><br>with series resistor for 110/125 V and incandescent lamp 60 V, 33 mA | Plastic grey | <b>704.642.1</b>   | 5               | 0.020   |
| with series resistor for 220/240 V and incandescent lamp 130 V, 20 mA   | Plastic grey | <b>704.642.2</b>   | 5               | 0.009   |
| without built-in series resistor  | Plastic grey | <b>704.642.0</b>   | 5               | 0.006   |



Circuit drawing from page 115

## Lens cap round, plastic

|                                | Lens cap               | Ø 29 mm<br>Typ-Nr. |  |
|--------------------------------|------------------------|--------------------|---|
| <b>Lens cap round, plastic</b> | blue transparent       | <b>704.603.6</b>   | 0.003   |
|                                | colourless transparent | <b>704.603.7</b>   | 0.003   |
|                                | green transparent      | <b>704.603.5</b>   | 0.003   |
|                                | red transparent        | <b>704.603.2</b>   | 0.003   |
|                                | yellow transparent     | <b>704.603.4</b>   | 0.003   |



## Marking cap for Lens cap round

|  | Marking cap                           | Typ-Nr.          |  |
|--|---------------------------------------|------------------|---|
| <b>Marking cap for Lens cap round</b><br>LED | Plastic colourless transparent ribbed | <b>704.608.7</b> | 0.002   |
| LED and Filament lamp                        | Plastic white translucent             | <b>704.608.9</b> | 0.002   |



## Indicator and Flasher round, full face illumination

## Indicator actuator round, full face illumination

|   | Housing      | Ø 29 mm<br>Typ-Nr. |  |
|---|--------------|--------------------|---|
| <b>Indicator actuator round, full face illumination</b> | Plastic grey | <b>704.630.1</b>   | 0.020   |



## Lens cap round, plastic

|                                | Lens cap               | Ø 29 mm<br>Typ-Nr. |  |
|--------------------------------|------------------------|--------------------|---|
| <b>Lens cap round, plastic</b> | blue transparent       | <b>704.603.6</b>   | 0.003   |
|                                | colourless transparent | <b>704.603.7</b>   | 0.003   |
|                                | green transparent      | <b>704.603.5</b>   | 0.003   |
|                                | red transparent        | <b>704.603.2</b>   | 0.003   |
|                                | yellow transparent     | <b>704.603.4</b>   | 0.003   |



## Marking cap for Lens cap round

|                                       | Marking cap                           | Typ-Nr.          |  |
|---------------------------------------|---------------------------------------|------------------|---|
| <b>Marking cap for Lens cap round</b> | LED                                   | <b>704.608.7</b> | 0.002   |
|                                       | LED and Filament lamp                 |                  |   |
|                                       | Plastic colourless transparent ribbed | <b>704.608.7</b> | 0.002   |
|                                       | Plastic white translucent             | <b>704.608.9</b> | 0.002   |



## Bayonet flange

|                       | Typ-Nr.          | Technical drawing |  |
|-----------------------|------------------|-------------------|---|
| <b>Bayonet flange</b> | <b>704.960.5</b> | 48                | 0.025   |
| Metal                 |                  |                   |   |
| Plastic               | <b>704.950.5</b> | 47                | 0.015   |



Technical drawing from page 95

## Lamp block

|   | Terminals                     | Typ-Nr.            | Technical drawing  | Circuit drawing |  |
|---|-------------------------------|--------------------|--------------------|-----------------|---|
| <b>Lamp block</b>                       | PIT                           | <b>704.950.3</b>   | 42                 | 5               | 0.014   |
|   |                               |                    |                    |                 |   |
| Standard                                | PT 6.3                        | <b>704.950.1</b>   | 40                 | 5               | 0.012   |
|   | ST                            | <b>704.950.0</b>   | 39                 | 5               | 0.012   |
|   | Terminals Cu/Sn nickel plated | D-PT 6.3           | <b>704.950.2/D</b> | 41              | 5   |
| Terminals Cu/Sn nickel plated and blank | D-PT 6.3                      | <b>704.950.1/D</b> | 41                 | 5               | 0.013   |
| Terminals for ring cable shoe           | ST                            | <b>704.950.0B</b>  | 39                 | 5               | 0.013   |

Terminals: PIT = PIT Spring terminal, PT 6.3 = Plug-in terminal 6.3 mm, ST = Screw terminal, D-PT 6.3 = Double plug-in terminal 6.3 mm

Technical drawing from page 95, Circuit drawing from page 115



## Indicator and Flasher square, full face illumination

### Indicator actuator square, full face illumination

|   | Housing       | ∅ 30 x 30 mm<br>Typ-Nr. |  |
|---|---------------|-------------------------|---|
| Indicator actuator square, full face illumination | Plastic black | <b>704.730.0</b>        | 0.005   |
|   | Plastic grey  | <b>704.730.1</b>        | 0.005   |



### Lens cap square, plastic

|                          | Lens cap               | ∅ 30 x 30 mm<br>Typ-Nr. |  |
|--------------------------|------------------------|-------------------------|---|
| Lens cap square, plastic | blue transparent       | <b>704.703.6</b>        | 0.003   |
|                          | colourless transparent | <b>704.703.7</b>        | 0.003   |
|                          | green transparent      | <b>704.703.5</b>        | 0.003   |
|                          | red transparent        | <b>704.703.2</b>        | 0.003   |
|                          | yellow transparent     | <b>704.703.4</b>        | 0.003   |



### Diffusor cap for Lens cap square

|   | Diffusor cap       | ∅ 30 x 30 mm<br>Typ-Nr. |  |
|---|--------------------|-------------------------|---|
| Diffusor cap for Lens cap square<br>can be marked | Plastic white      | <b>704.708.9</b>        | 0.004   |
| LED   | Plastic colourless | <b>704.708.7</b>        | 0.004   |



### Marking foil for Lens square

|  | Marking foil                   | Typ-Nr.          |  |
|--|--------------------------------|------------------|---|
| Marking foil for Lens square<br>can be hot stamped | Plastic colourless transparent | <b>704.706.7</b> | 0.001   |



### Bayonet flange

|                         | Typ-Nr.          | Technical drawing |  |
|-------------------------|------------------|-------------------|---|
| Bayonet flange<br>Metal | <b>704.960.5</b> | 48                | 0.025   |
| Plastic                 | <b>704.950.5</b> | 47                | 0.015   |



Technical drawing from page 95

## Lamp block

|   | Terminals | Typ-Nr.            | Technical drawing | Circuit drawing |  |
|---|-----------|--------------------|-------------------|-----------------|---|
| <b>Lamp block</b><br>Spring terminal    | PIT       | <b>704.950.3</b>   | 42                | 5               | 0.014   |
| Standard                                | PT 6.3    | <b>704.950.1</b>   | 40                | 5               | 0.012   |
|   | ST        | <b>704.950.0</b>   | 39                | 5               | 0.012   |
| Terminals Cu/Sn nickel plated           | D-PT 6.3  | <b>704.950.2/D</b> | 41                | 5               | 0.013   |
| Terminals Cu/Sn nickel plated and blank | D-PT 6.3  | <b>704.950.1/D</b> | 41                | 5               | 0.013   |
| Terminals for ring cable shoe           | ST        | <b>704.950.0B</b>  | 39                | 5               | 0.013   |

Terminals: PIT = PIT Spring terminal, PT 6.3 = Plug-in terminal 6.3 mm, ST = Screw terminal, D-PT 6.3 = Double plug-in terminal 6.3 mm

Technical drawing from page 95, Circuit drawing from page 115



## Indicator and Flasher round, front illumination

### Indicator actuator round, front illumination

|   | Housing      | Typ-Nr.          |  |
|---|--------------|------------------|--|
| <b>Indicator actuator round, front illumination</b> | Plastic grey | <b>704.633.1</b> | 0.020  |



### Lens round, flush, plastic

Lenses are usable for round devices in raised and flush mounting

|                                   | Lens                   | Symbol  | Typ-Nr.             |  |
|-----------------------------------|------------------------|---------|---------------------|---|
| <b>Lens round, flush, plastic</b> | black opaque           | without | <b>704.602.0</b>    | 0.001   |
|                                   | blue transparent       | without | <b>704.602.6</b>    | 0.001   |
|                                   | colourless transparent | Halo    | <b>704.602.7A01</b> | 0.001   |
|                                   |                        | without | <b>704.602.7</b>    | 0.001   |
|                                   | green transparent      | without | <b>704.602.5</b>    | 0.001   |
|                                   | red transparent        | without | <b>704.602.2</b>    | 0.001   |
|                                   | yellow transparent     | without | <b>704.602.4</b>    | 0.001   |



### Marking plate for Lens round, flush

|   | Marking plate                         | Typ-Nr.             |  |
|---|---------------------------------------|---------------------|---|
| <b>Marking plate for Lens round, flush</b><br>Halo illumination | Plastic white translucent             | <b>704.609.9A01</b> | 0.001   |
| LED   | Plastic colourless transparent ribbed | <b>704.609.7</b>    | 0.001   |
| LED and Filament lamp   | Plastic white translucent             | <b>704.609.9</b>    | 0.001   |
| non-illuminative  | Plastic black opaque                  | <b>704.609.0</b>    | 0.001   |



## Lens round raised, plastic

|                                   | Lens                   | Typ-Nr.          |  |
|-----------------------------------|------------------------|------------------|---|
| <b>Lens round raised, plastic</b> | colourless transparent | <b>704.611.7</b> | 0.002   |
|                                   | green transparent      | <b>704.611.5</b> | 0.002   |
|                                   | red transparent        | <b>704.611.2</b> | 0.002   |
|                                   | yellow transparent     | <b>704.611.4</b> | 0.002   |



## Marking cap for Lens round, raised

|   | Marking cap                           | Typ-Nr.          |  |
|---|---------------------------------------|------------------|---|
| <b>Marking cap for Lens round, raised LED</b> | Plastic colourless transparent ribbed | <b>704.610.7</b> | 0.001   |
| LED and Filament lamp                         | Plastic white translucent             | <b>704.610.9</b> | 0.001   |



## Front bezel set for Indicator and Pushbutton, flush mounting

|   | Front bezel             | Ø 35 mm<br>Typ-Nr. | Mounting dimensions |  |
|---|-------------------------|--------------------|---------------------|---|
| <b>Front bezel set for Indicator and Pushbutton, flush mounting</b> | Aluminium black         | <b>704.955.0</b>   | 7                   | 0.015   |
|   | Aluminium natural       | <b>704.955.1</b>   | 7                   | 0.015   |
|   | Stainless steel natural | <b>704.955.9</b>   | 7                   | 0.033   |



Mounting dimensions from page 91

## Front bezel with protective membrane, flush mounting

for Pushbutton and Illuminated pushbutton (IP 67)

|  | Front bezel             | Ø 35 mm<br>Typ-Nr. |  |
|--|-------------------------|--------------------|---|
| <b>Front bezel with protective membrane, flush mounting with transparent silicone membrane</b> | Aluminium black         | <b>704.955.4</b>   | 0.015   |
|  | Aluminium natural       | <b>704.955.3</b>   | 0.015   |
| with transparent silicone membrane, resistant to sea water                                     | Stainless steel natural | <b>704.955.9E</b>  | 0.033   |



Front bezel to be mounted with a torque of 40 Ncm onto actuator.

## Front ring

|                   | Front ring              | Ø 29 mm<br>Typ-Nr. |  |
|-------------------|-------------------------|--------------------|---|
| <b>Front ring</b> | Aluminium black         | <b>704.600.1A</b>  | 0.005   |
|                   | Aluminium natural       | <b>704.600.1</b>   | 0.005   |
|                   | Plastic black           | <b>704.600.0</b>   | 0.003   |
|                   | Plastic light-grey      | <b>704.600.6</b>   | 0.003   |
|                   | Stainless steel natural | <b>704.600.9</b>   | 0.006   |
| Heigth 16 mm      | Plastic light-grey      | <b>704.600.7</b>   | 0.003   |



## Front protective cap

for Indicator, Pushbutton and Illuminated pushbutton for protection IP 68

|   | Front protective cap            | Typ-Nr.          |  |
|---|---------------------------------|------------------|---|
| <b>Front protective cap</b><br>only together with Lenses 704.602.X, 704.601.X and Front rings 704.600.X | Silicone colourless transparent | <b>704.953.0</b> | 0.002   |



## Front protective ring

for Pushbutton and Illuminated pushbutton with front illumination (IP 67)

|   | Front protective ring | Ø 29 mm<br>Typ-Nr. |  |
|---|-----------------------|--------------------|---|
| <b>Front protective ring</b><br>with transparent Pebax membrane, temperature resistance<br>-40 °C ... +85 °C    | Aluminium natural     | <b>704.600.5/A</b> | 0.005   |
|   | Aluminium natural     | <b>704.600.3</b>   | 0.005   |
| with transparent silicone membrane (extent resistant to sea water),<br>temperature resistance -40 °C ... +85 °C | Chromed brass         | <b>704.600.2</b>   | 0.005   |



Front protective ring to be mounted with a torque of 40 Ncm onto actuator.

## Bayonet flange

|                                | Typ-Nr.          | Technical drawing |  |
|--------------------------------|------------------|-------------------|---|
| <b>Bayonet flange</b><br>Metal | <b>704.960.5</b> | 48                | 0.025   |
| Plastic                        | <b>704.950.5</b> | 47                | 0.015   |



Technical drawing from page 95

## Lamp block

|   | Terminals | Typ-Nr.            | Technical drawing | Circuit drawing | kg    |
|---|-----------|--------------------|-------------------|-----------------|-------|
| <b>Lamp block</b>                       | PIT       | <b>704.950.3</b>   | 42                | 5               | 0.014 |
| Spring terminal                         |           |                    |                   |                 |       |
| Standard                                | PT 6.3    | <b>704.950.1</b>   | 40                | 5               | 0.012 |
|   | ST        | <b>704.950.0</b>   | 39                | 5               | 0.012 |
| Terminals Cu/Sn nickel plated           | D-PT 6.3  | <b>704.950.2/D</b> | 41                | 5               | 0.013 |
| Terminals Cu/Sn nickel plated and blank | D-PT 6.3  | <b>704.950.1/D</b> | 41                | 5               | 0.013 |
| Terminals for ring cable shoe           | ST        | <b>704.950.0B</b>  | 39                | 5               | 0.013 |

Terminals: PIT = PIT Spring terminal, PT 6.3 = Plug-in terminal 6.3 mm, ST = Screw terminal, D-PT 6.3 = Double plug-in terminal 6.3 mm

Technical drawing from page 95, Circuit drawing from page 115



## Indicator and Flasher square, front illumination

### Indicator actuator square, front illumination

|  | Front bezel | Housing       | ∅ 35 x 35 mm<br>Typ-Nr. | ∅ 30 x 30 mm<br>Typ-Nr. | kg    |       |
|--|-------------|---------------|-------------------------|-------------------------|-------|-------|
| <b>Indicator actuator square, front illumination</b> | black       | Plastic black | <b>704.743.0</b>        |                         | 0.020 |       |
|  | silver      | Plastic black | <b>704.743.8</b>        |                         | 0.020 |       |
|  | without     | Plastic black |                         | <b>704.733.0</b>        |       | 0.020 |
|  |             | Plastic grey  |                         | <b>704.733.1</b>        |       | 0.020 |



### Lens square, plastic

|                             | Lens                   | ∅ 35 x 35 mm<br>Typ-Nr. | ∅ 30 x 30 mm<br>Typ-Nr. | kg    |
|-----------------------------|------------------------|-------------------------|-------------------------|-------|
| <b>Lens square, plastic</b> | blue transparent       | <b>704.702.6</b>        | <b>704.702.6</b>        | 0.001 |
|                             | colourless transparent | <b>704.702.7</b>        | <b>704.702.7</b>        | 0.001 |
|                             | green transparent      | <b>704.702.5</b>        | <b>704.702.5</b>        | 0.001 |
|                             | red transparent        | <b>704.702.2</b>        | <b>704.702.2</b>        | 0.001 |
|                             | yellow transparent     | <b>704.702.4</b>        | <b>704.702.4</b>        | 0.001 |



### Lens holder for Lens square

|   | Lens holder            | Typ-Nr.          | kg    |
|---|------------------------|------------------|-------|
| <b>Lens holder for Lens square</b><br>can be marked | translucent white      | <b>704.709.9</b> | 0.003 |
| LED   | transparent colourless | <b>704.709.7</b> | 0.003 |





## Marking foil for Lens square

|   | Marking foil                   | Typ-Nr.          |  |
|---|--------------------------------|------------------|---|
| <b>Marking foil for Lens square</b><br>can be hot stamped | Plastic colourless transparent | <b>704.707.7</b> | 0.001   |



## Front bezel square

|                           | Front bezel             | ∅ 30 x 30 mm<br>Typ-Nr. |  |
|---------------------------|-------------------------|-------------------------|---|
| <b>Front bezel square</b> | Plastic black           | <b>704.701.0</b>        | 0.002   |
|                           | Plastic chromium-plated | <b>704.701.4</b>        | 0.002   |
|                           | Plastic grey            | <b>704.701.6</b>        | 0.002   |



## Bayonet flange

|                                | Typ-Nr.          | Technical drawing |  |
|--------------------------------|------------------|-------------------|---|
| <b>Bayonet flange</b><br>Metal | <b>704.960.5</b> | 48                | 0.025   |
| Plastic                        | <b>704.950.5</b> | 47                | 0.015   |



Technical drawing from page 95

## Lamp block

|   | Terminals | Typ-Nr.            | Technical drawing | Circuit drawing |  |
|---|-----------|--------------------|-------------------|-----------------|---|
| <b>Lamp block</b><br>Spring terminal    | PIT       | <b>704.950.3</b>   | 42                | 5               | 0.014   |
| Standard                                | PT 6.3    | <b>704.950.1</b>   | 40                | 5               | 0.012   |
|   | ST        | <b>704.950.0</b>   | 39                | 5               | 0.012   |
| Terminals Cu/Sn nickel plated           | D-PT 6.3  | <b>704.950.2/D</b> | 41                | 5               | 0.013   |
| Terminals Cu/Sn nickel plated and blank | D-PT 6.3  | <b>704.950.1/D</b> | 41                | 5               | 0.013   |
| Terminals for ring cable shoe           | ST        | <b>704.950.0B</b>  | 39                | 5               | 0.013   |



Terminals: PIT = PIT Spring terminal, PT 6.3 = Plug-in terminal 6.3 mm, ST = Screw terminal, D-PT 6.3 = Double plug-in terminal 6.3 mm

Technical drawing from page 95, Circuit drawing from page 115

## Pushbutton and Illuminated pushbutton round

### Pushbutton- and Illuminated pushbutton actuator round

Actuators usable for devices with front dimension 29 mm dia., raised mounting and 35 mm dia., flush mounting

|  | Switching action | Housing      | Typ-Nr.          |  |
|--|------------------|--------------|------------------|---|
| <b>Pushbutton- and Illuminated pushbutton actuator round</b> | MA               | Plastic grey | <b>704.632.1</b> | 0.009   |
|  | M                | Plastic grey | <b>704.631.1</b> | 0.009   |



Switching action: MA = Maintained action, M = Momentary action

### Lens round, flush, plastic

Lenses are usable for round devices in raised and flush mounting

|                                   | Lens                   | Symbol  | Typ-Nr.             |  |
|-----------------------------------|------------------------|---------|---------------------|---|
| <b>Lens round, flush, plastic</b> | black opaque           | without | <b>704.602.0</b>    | 0.001   |
|                                   | blue transparent       | without | <b>704.602.6</b>    | 0.001   |
|                                   | colourless transparent | Halo    | <b>704.602.7A01</b> | 0.001   |
|                                   |                        | without | <b>704.602.7</b>    | 0.001   |
|                                   | green transparent      | without | <b>704.602.5</b>    | 0.001   |
|                                   | red transparent        | without | <b>704.602.2</b>    | 0.001   |
|                                   | yellow transparent     | without | <b>704.602.4</b>    | 0.001   |



### Marking plate for Lens round, flush

|  | Marking plate                         | Typ-Nr.             |  |
|--|---------------------------------------|---------------------|---|
| <b>Marking plate for Lens round, flush</b> | Plastic white translucent             | <b>704.609.9A01</b> | 0.001   |
| Halo illumination                          |                                       |                     |   |
| LED  | Plastic colourless transparent ribbed | <b>704.609.7</b>    | 0.001   |
| LED and Filament lamp                      | Plastic white translucent             | <b>704.609.9</b>    | 0.001   |
| non-illuminative                           | Plastic black opaque                  | <b>704.609.0</b>    | 0.001   |



### Lens round, metal

|                          | Lens                    | Ø 29 mm<br>Typ-Nr. |  |
|--------------------------|-------------------------|--------------------|---|
| <b>Lens round, metal</b> | Aluminium black         | <b>704.601.0</b>   | 0.001   |
|                          | Aluminium blue          | <b>704.601.6</b>   | 0.001   |
|                          | Aluminium gold          | <b>704.601.4</b>   | 0.001   |
|                          | Aluminium natural       | <b>704.601.8</b>   | 0.001   |
|                          | Aluminium olive-green   | <b>704.601.5</b>   | 0.001   |
|                          | Aluminium red           | <b>704.601.2</b>   | 0.001   |
|                          | Stainless steel natural | <b>704.601.9</b>   | 0.001   |



## Lens round, metal with spot

|                                    | Lens                    | Ø 29 mm<br>Typ-Nr. |  |
|------------------------------------|-------------------------|--------------------|---|
| <b>Lens round, metal with spot</b> | Aluminium black         | <b>704.601.01</b>  | 0.001   |
|                                    | Aluminium blue          | <b>704.601.61</b>  | 0.001   |
|                                    | Aluminium gold          | <b>704.601.41</b>  | 0.001   |
|                                    | Aluminium natural       | <b>704.601.81</b>  | 0.001   |
|                                    | Aluminium olive-green   | <b>704.601.51</b>  | 0.001   |
|                                    | Aluminium red           | <b>704.601.21</b>  | 0.001   |
|                                    | Stainless steel natural | <b>704.601.91</b>  | 0.001   |



## Front bezel set for Indicator and Pushbutton, flush mounting

|   | Front bezel             | Ø 35 mm<br>Typ-Nr. | Mounting dimensions |  |
|---|-------------------------|--------------------|---------------------|---|
| <b>Front bezel set for Indicator and Pushbutton, flush mounting</b> | Aluminium black         | <b>704.955.0</b>   | 7                   | 0.015   |
|   | Aluminium natural       | <b>704.955.1</b>   | 7                   | 0.015   |
|   | Stainless steel natural | <b>704.955.9</b>   | 7                   | 0.033   |



Mounting dimensions from page 91

## Front bezel with protective membrane, flush mounting

for Pushbutton and Illuminated pushbutton (IP 67)

|   | Front bezel             | Ø 35 mm<br>Typ-Nr. |  |
|---|-------------------------|--------------------|---|
| <b>Front bezel with protective membrane, flush mounting</b><br>with transparent silicone membrane | Aluminium black         | <b>704.955.4</b>   | 0.015   |
|   | Aluminium natural       | <b>704.955.3</b>   | 0.015   |
| with transparent silicone membrane, resistant to sea water  | Stainless steel natural | <b>704.955.9E</b>  | 0.033   |



Front bezel to be mounted with a torque of 40 Ncm onto actuator.

## Front ring

|                   | Front ring              | Ø 29 mm<br>Typ-Nr. |  |
|-------------------|-------------------------|--------------------|---|
| <b>Front ring</b> | Aluminium black         | <b>704.600.1A</b>  | 0.005   |
|                   | Aluminium natural       | <b>704.600.1</b>   | 0.005   |
|                   | Plastic black           | <b>704.600.0</b>   | 0.003   |
|                   | Plastic light-grey      | <b>704.600.6</b>   | 0.003   |
|                   | Stainless steel natural | <b>704.600.9</b>   | 0.006   |
| Heigth 16 mm      | Plastic light-grey      | <b>704.600.7</b>   | 0.003   |



## Front protective cap

for Indicator, Pushbutton and Illuminated pushbutton for protection IP 68

|   | Front protective cap            | Typ-Nr.          |  |
|---|---------------------------------|------------------|---|
| <b>Front protective cap</b><br>only together with Lenses 704.602.X, 704.601.X and Front rings 704.600.X | Silicone colourless transparent | <b>704.953.0</b> | 0.002   |



## Front protective ring

for Pushbutton and Illuminated pushbutton with front illumination (IP 67)

|   | Front protective ring | Ø 29 mm<br>Typ-Nr. |  |
|---|-----------------------|--------------------|---|
| <b>Front protective ring</b><br>with transparent Pebax membrane, temperature resistance<br>-40 °C ... +85 °C    | Aluminium natural     | <b>704.600.5/A</b> | 0.005   |
| with transparent silicone membrane (extent resistant to sea water),<br>temperature resistance -40 °C ... +85 °C | Aluminium natural     | <b>704.600.3</b>   | 0.005   |
|   | Chromed brass         | <b>704.600.2</b>   | 0.005   |



Front protective ring to be mounted with a torque of 40 Ncm onto actuator.

## Bayonet flange

|                                | Typ-Nr.          | Technical drawing |  |
|--------------------------------|------------------|-------------------|---|
| <b>Bayonet flange</b><br>Metal | <b>704.960.5</b> | 48                | 0.025   |
| Plastic                        | <b>704.950.5</b> | 47                | 0.015   |



Technical drawing from page 95

## Lamp block

|   | Terminals | Typ-Nr.            | Technical drawing | Circuit drawing |  |
|---|-----------|--------------------|-------------------|-----------------|---|
| <b>Lamp block</b><br>Spring terminal    | PIT       | <b>704.950.3</b>   | 42                | 5               | 0.014   |
| Standard                                | PT 6.3    | <b>704.950.1</b>   | 40                | 5               | 0.012   |
|   | ST        | <b>704.950.0</b>   | 39                | 5               | 0.012   |
| Terminals Cu/Sn nickel plated           | D-PT 6.3  | <b>704.950.2/D</b> | 41                | 5               | 0.013   |
| Terminals Cu/Sn nickel plated and blank | D-PT 6.3  | <b>704.950.1/D</b> | 41                | 5               | 0.013   |
| Terminals for ring cable shoe           | ST        | <b>704.950.0B</b>  | 39                | 5               | 0.013   |



Terminals: PIT = PIT Spring terminal, PT 6.3 = Plug-in terminal 6.3 mm, ST = Screw terminal, D-PT 6.3 = Double plug-in terminal 6.3 mm

Technical drawing from page 95, Circuit drawing from page 115

## Pushbutton and Illuminated pushbutton square

## Pushbutton- and Illuminated pushbutton actuator square

|  | Switching action | Front bezel | Housing       | Ø 35 x 35 mm<br>Typ-Nr. | Ø 30 x 30 mm<br>Typ-Nr. |  |
|--|------------------|-------------|---------------|-------------------------|-------------------------|---|
| Pushbutton- and Illuminated pushbutton actuator square | MA               | black       | Plastic black | <b>704.742.0</b>        |                         | 0.020   |
|  |                  | silver      | Plastic black | <b>704.742.8</b>        |                         | 0.020   |
|  | M                | black       | Plastic black | <b>704.741.0</b>        |                         | 0.020   |
|  |                  | silver      | Plastic black | <b>704.741.8</b>        |                         | 0.020   |
|  | MA               | without     | Plastic black |                         | <b>704.732.0</b>        | 0.020   |
|  |                  |             | Plastic grey  |                         | <b>704.732.1</b>        | 0.020   |
|  | M                | without     | Plastic black |                         | <b>704.731.0</b>        | 0.020   |
|  |                  |             | Plastic grey  |                         | <b>704.731.1</b>        | 0.020   |



Switching action: MA = Maintained action, M = Momentary action

## Lens square, plastic

|                      | Lens                   | Typ-Nr.          |  |
|----------------------|------------------------|------------------|--|
| Lens square, plastic | black opaque           | <b>704.702.0</b> | 0.001  |
|                      | blue transparent       | <b>704.702.6</b> | 0.001  |
|                      | colourless transparent | <b>704.702.7</b> | 0.001  |
|                      | green transparent      | <b>704.702.5</b> | 0.001  |
|                      | red transparent        | <b>704.702.2</b> | 0.001  |
|                      | white opaque           | <b>704.702.9</b> | 0.001  |
|                      | yellow transparent     | <b>704.702.4</b> | 0.001  |



Lenses are usable for square devices in raised and flush mounting

## Lens holder for Lens square

|  | Lens holder            | Typ-Nr.          |  |
|--|------------------------|------------------|---|
| Lens holder for Lens square<br>can be marked | translucent white      | <b>704.709.9</b> | 0.003   |
| LED  | transparent colourless | <b>704.709.7</b> | 0.003   |



## Marking foil for Lens square

|  | Marking foil                   | Typ-Nr.          |  |
|--|--------------------------------|------------------|---|
| Marking foil for Lens square<br>can be hot stamped | Plastic colourless transparent | <b>704.707.7</b> | 0.001   |



## Front bezel square

|                           | Front bezel             | ∅ 30 x 30 mm<br>Typ-Nr. | kg    |
|---------------------------|-------------------------|-------------------------|-------|
| <b>Front bezel square</b> | Plastic black           | <b>704.701.0</b>        | 0.002 |
|                           | Plastic chromium-plated | <b>704.701.4</b>        | 0.002 |
|                           | Plastic grey            | <b>704.701.6</b>        | 0.002 |



## Bayonet flange

|                                | Typ-Nr.          | Technical drawing | kg    |
|--------------------------------|------------------|-------------------|-------|
| <b>Bayonet flange</b><br>Metal | <b>704.960.5</b> | 48                | 0.025 |
| Plastic                        | <b>704.950.5</b> | 47                | 0.015 |



Technical drawing from page 95

## Lamp block

|   | Terminals | Typ-Nr.            | Technical drawing | Circuit drawing | kg    |
|---|-----------|--------------------|-------------------|-----------------|-------|
| <b>Lamp block</b><br>Spring terminal    | PIT       | <b>704.950.3</b>   | 42                | 5               | 0.014 |
| Standard                                | PT 6.3    | <b>704.950.1</b>   | 40                | 5               | 0.012 |
|   | ST        | <b>704.950.0</b>   | 39                | 5               | 0.012 |
| Terminals Cu/Sn nickel plated           | D-PT 6.3  | <b>704.950.2/D</b> | 41                | 5               | 0.013 |
| Terminals Cu/Sn nickel plated and blank | D-PT 6.3  | <b>704.950.1/D</b> | 41                | 5               | 0.013 |
| Terminals for ring cable shoe           | ST        | <b>704.950.0B</b>  | 39                | 5               | 0.013 |



Terminals: PIT = PIT Spring terminal, PT 6.3 = Plug-in terminal 6.3 mm, ST = Screw terminal, D-PT 6.3 = Double plug-in terminal 6.3 mm

Technical drawing from page 95, Circuit drawing from page 115

## Snap-action switching element

### Switching system

The double-break, snap-action switching element is equipped with one or two independent contact systems, acting as normally open or normally closed contact. The snap-action switching element is fitted with self-cleaning contacts.

Up to three switching elements can be snapped to each actuator. Snap-action switching elements are not permissible for emergency-stop pushbuttons!

### Material

#### Material of contact

Hardsilver, gold-silver, silver-palladium (for aggressive atmospheres)

#### Switch housing

Polycarbonate (PC)

### Mechanical characteristics

#### Terminals

Screw terminals

Plug-in terminals 6.3 x 0.8 mm

max. wire cross-section 2 x 2.5 mm<sup>2</sup>

max. wire cross-section of stranded cable 2 x 1.5 mm<sup>2</sup>

For switches with plug-in terminals it is necessary to provide insulation sleeves and to maintain a spacing of 65 mm between rows (mounting dimensions)

#### Tightening torque

Screws at the mounting flange max. 25 Ncm

Screws at switching element max. 50 Ncm

#### Actuating force

1 Normally closed 1.9 N

1 Normally open 2 N

#### Actuating travel

5.8 mm ± 0.2 mm

#### Rebound time

≤ 3 ms

#### Mechanical lifetime

(with 1 switching element)

Pushbutton maintained action 1.5 million Cycles of operation

Pushbutton momentary action 3 million Cycles of operation

Selector switch maintained action 1.25 million Cycles of operation

Selector switch momentary action 2.5 million Cycles of operation

Keylock switch maintained action 25 000 Cycles of operation

Keylock switch momentary action 50 000 Cycles of operation

### Electrical characteristics

#### Standards

The switches comply with the "Standards for low-voltage switching devices" EN IEC 60947-5-1

#### Rated Insulation Voltage U<sub>i</sub>

500 VAC / 600 VDC, as per EN IEC 60947-5-1

#### Contact resistance

New state ≤ 50 mΩ as per DIN IEC 60512-2-4

#### Isolation resistance

≥ 10 MΩ between open contacts at 500 VDC, as per DIN IEC 60512-2-10

#### Electrical life

50 000 cycles of operations

#### Conventional free air thermal current I<sub>th</sub>

10 A, as per EN IEC 60947-5-1

the maximum current in continuous operation and at ambient temperature must not exceed the quoted maximum values.

#### Switch rating

At switch rating AC for gold-silver, silver-palladium and hardsilver contacts, service category AC-15, as per EN IEC 60947-5-1 (cosφ 0.3)

|         |         |         |         |
|---------|---------|---------|---------|
| Voltage | 230 VAC | 400 VAC | 500 VAC |
| Current | 6 A     | 4 A     | 2.5 A   |

At switch rating DC for gold-silver and hardsilver contacts, service category DC-13, as per EN IEC 60947-5-1

|         |        |        |         |
|---------|--------|--------|---------|
| Voltage | 24 VDC | 60 VDC | 110 VDC |
| Current | 10 A   | 3 A    | 1 A     |

#### Recommended minimum operational data

Gold-silver contacts:

|         |       |        |         |
|---------|-------|--------|---------|
| Voltage | 5 VDC | 24 VDC | 110 VDC |
| Current | 15 mA | 5 mA   | 2 mA    |

Hardsilver contacts:

|         |        |         |
|---------|--------|---------|
| Voltage | 24 VDC | 110 VDC |
| Current | 50 mA  | 10 mA   |

#### Protection class

Indicators and switches, fit for mounting into devices with protection class II

### Environmental conditions

#### Storage temperature

-40 °C ... +85 °C

#### Operating temperature

-40 °C ... +55 °C

#### Protection degree

IP 20

#### Shock resistance

(single impacts, semi-sinusoidal)

300 m/s<sup>2</sup>puls width 11 ms, as per EN IEC 60068-2-27

#### Vibration resistance

(sinusoidal)

100 m/s<sup>2</sup> at 10 Hz ... 500 Hz, amplitude 0,75 mm, as per EN IEC 60068-2-6

### Approvals

#### Approbations

CB (IEC 60947)

CCC

CSA

Germanischer Lloyd

GOST

NFF 16-102

SEV

UL

**Declaration of conformity**  
CE

## Slow-make switching element

### Switching system

The double-break, slow-make switching element is equipped with one or two independent contact systems, acting as normally open or normally closed contact. The normally closed contact has forced opening.

Slow-make contacts with forced action are ideal for high switch ratings.

Up to three switching elements can be snapped to each actuator. For the emergency-stop pushbutton use the slow-make switching element (max. 2).

### Material

#### Material of contact

Hardsilver, gold-silver, silver-palladium (for aggressive atmospheres)

#### Switch housing

Polycarbonate (PC)

### Mechanical characteristics

#### Terminals

Screw terminals

Plug-in terminals 6.3 x 0.8 mm

max. wire cross-section 2 x 2.5 mm<sup>2</sup>

max. wire cross-section of stranded cable 2 x 1.5 mm<sup>2</sup>

For switches with plug-in terminals it is necessary to provide insulation sleeves and to maintain a spacing of 65 mm between rows (mounting dimensions)

#### Tightening torque

Screws at the mounting flange max. 25 Ncm

Screws at switching element max. 50 Ncm

#### Actuating force

1 Normally closed 2 N

1 Normally open 3.1 N

#### Actuating travel

5.8 mm ± 0.2 mm

#### Rebound time

≤1 ms

#### Mechanical lifetime

(with 1 switching element)

|                                   |              |                     |
|-----------------------------------|--------------|---------------------|
| Pushbutton maintained action      | 1.5 million  | Cycles of operation |
| Pushbutton momentary action       | 3 million    | Cycles of operation |
| Selector switch maintained action | 1.25 million | Cycles of operation |
| Selector switch momentary action  | 2.5 million  | Cycles of operation |
| Emergency-stop switch             | 50 000       | Cycles of operation |
| Keylock switch maintained action  | 25 000       | Cycles of operation |
| Keylock switch momentary action   | 50 000       | Cycles of operation |

### Electrical characteristics

#### Standards

The switches comply with the "Standards for low-voltage switching devices" EN IEC 60947-5-1

#### Rated Insulation Voltage U<sub>i</sub>

500 VAC / 600 VDC, as per EN IEC 60947-5-1

#### Contact resistance

New state ≤50 mΩ as per DIN IEC 60512-2-4

#### Isolation resistance

≥10 MΩ between open contacts at 500 VDC, as per DIN IEC 60512-2-10

#### Electrical life

50 000 cycles of operations

#### Conventional free air thermal current I<sub>th</sub>

10 A, as per EN IEC 60947-5-1

the maximum current in continuous operation and at ambient temperature must not exceed the quoted maximum values.

#### Switch rating

At switch rating AC for gold-silver, silver-palladium and hardsilver contacts, service category AC-15, as per EN IEC 60947-5-1 (cosφ 0.3)

|         |         |         |         |
|---------|---------|---------|---------|
| Voltage | 230 VAC | 400 VAC | 500 VAC |
| Current | 7 A     | 5 A     | 4 A     |

At switch rating DC for gold-silver and hardsilver contacts, service category DC-13, as per EN IEC 60947-5-1

|         |        |        |         |         |
|---------|--------|--------|---------|---------|
| Voltage | 24 VDC | 60 VDC | 110 VDC | 250 VDC |
| Current | 10 A   | 5 A    | 2.5 A   | 0.6 A   |

#### Recommended minimum operational data

Gold-silver contacts:

|         |        |         |
|---------|--------|---------|
| Voltage | 24 VDC | 110 VDC |
| Current | 10 mA  | 2 mA    |

Hardsilver contacts:

|         |        |         |
|---------|--------|---------|
| Voltage | 24 VDC | 110 VDC |
| Current | 50 mA  | 10 mA   |

#### Protection class

Indicators and switches, fit for mounting into devices with protection class II

### Environmental conditions

#### Storage temperature

-40 °C ... +85 °C

#### Operating temperature

-40 °C ... +55 °C

#### Protection degree

IP 20

#### Shock resistance

(single impacts, semi-sinusoidal)

300 m/s<sup>2</sup>puls width 11 ms, as per EN IEC 60068-2-27

#### Vibration resistance

(sinusoidal)

100 m/s<sup>2</sup> at 10 Hz ... 500 Hz, amplitude 0,75 mm, as per EN IEC 60068-2-6

### Approvals

#### Approbations

CB (IEC 60947)

CCC

CSA

Germanischer Lloyd

GOST

NFF 16-102



SEV  
UL

**Declaration of conformity**  
CE

## Snap-action switching element PIT

### Switching system

The double-break, snap-action switching element is equipped with one or two independent contact systems, acting as normally open or normally closed contact. The snap-action switching element is fitted with self-cleaning contacts.

Up to three switching elements can be snapped to each actuator. Snap-action switching elements are not permissible for emergency-stop pushbuttons!

### Material

**Material of contact**  
Hardsilver and gold-silver

**Switch housing**  
Polycarbonate (PC)

### Mechanical characteristics

#### Terminals

PIT Spring terminal  
Skinning 8 mm  
Wire cross-section:  
Wire 0.2 to 1.0 mm<sup>2</sup> Stranded wire 0.2 to 1.0 mm<sup>2</sup> without core and sleeve  
Stranded wire 0.2 to 0.75 mm<sup>2</sup> with core and sleeve

#### Tightening torque

Screws at the mounting flange max. 25 Ncm

#### Actuating force

1 Normally closed 1.9 N  
1 Normally open 2 N

#### Actuating travel

5.8 mm ± 0.2 mm

#### Rebound time

≤3 ms

#### Mechanical lifetime

(with 1 switching element)

|                                   |              |                     |
|-----------------------------------|--------------|---------------------|
| Pushbutton maintained action      | 1.5 million  | Cycles of operation |
| Pushbutton momentary action       | 3 million    | Cycles of operation |
| Selector switch maintained action | 1.25 million | Cycles of operation |
| Selector switch momentary action  | 2.5 million  | Cycles of operation |
| Emergency-stop switch             | 50 000       | Cycles of operation |
| Keylock switch maintained action  | 25 000       | Cycles of operation |
| Keylock switch momentary action   | 50 000       | Cycles of operation |

### Electrical characteristics

#### Standards

The switches comply with EN IEC 60947-1 / EN IEC 60947-5-1

#### Rated Insulation Voltage $U_i$

500 VAC / 600 VDC, as per EN IEC 60947-5-1

#### Contact resistance

New state ≤50 mΩ as per DIN IEC 60512-2-4

#### Isolation resistance

≥10 MΩ between open contacts at 500 VDC, as per DIN IEC 60512-2-10

#### Electrical life

50 000 cycles of operations

#### Conventional free air thermal current $I_{th}$

6 A, as per EN IEC 60947-5-1  
the maximum current in continuous operation and at ambient temperature must not exceed the quoted maximum values.

#### Switch rating

At switch rating AC for gold-silver and hardsilver contacts, service category AC-15, as per EN IEC 60947-5-1 (cosφ 0.3)

Voltage 250 VAC  
Current 6 A

At switch rating DC for gold-silver and hardsilver contacts, service category DC-13, as per EN IEC 60947-5-1

Voltage 24 VDC 110 VDC  
Current 6 A 1.0 A

#### Recommended minimum operational data

Gold-silver contacts:

Voltage 24 VDC  
Current 5 mA

Hardsilver contacts:

Voltage 24 VDC  
Current 50 mA

#### Protection class

Indicators and switches, fit for mounting into devices with protection class II

### Environmental conditions

#### Storage temperature

-40 °C ... +85 °C

#### Operating temperature

-40 °C ... +55 °C

#### Protection degree

IP 20

#### Shock resistance

(single impacts, semi-sinusoidal)  
300 m/s<sup>2</sup>puls width 11 ms, as per EN IEC 60068-2-27

#### Vibration resistance

(sinusoidal)  
100 m/s<sup>2</sup> at 10 Hz ... 500 Hz, as per EN IEC 60068-2-6 and EN 61373 Increased broad band noise, class 1B

### Approvals

#### Approbations

CB (IEC 60947)  
CCC  
CSA  
Germanischer Lloyd  
GOST  
NFF 16-102

#### Declaration of conformity

CE

## Slow-make switching element PIT

### Switching system

The double-break, slow-make switching element is equipped with one or two independent contact systems, acting as normally open or normally closed contact. The normally closed contact has forced opening.

Slow-make contacts with forced action are ideal for high switch ratings.

Up to three switching elements can be snapped to each actuator. For the emergency-stop pushbutton use the slow-make switching element (max. 2).

### Material

#### Material of contact

Hardsilver and gold-silver

#### Switch housing

Polycarbonate (PC)

### Mechanical characteristics

#### Terminals

PIT Spring terminal

Skinning 8 mm

Wire cross-section:

Wire 0.2 to 1.0 mm<sup>2</sup> Stranded wire 0.2 to 1.0 mm<sup>2</sup> without core and sleeve

Stranded wire 0.2 to 0.75 mm<sup>2</sup> with core and sleeve

#### Tightening torque

Screws at the mounting flange max. 25 Ncm

#### Actuating force

1 Normally closed 2 N

1 Normally open 3.1 N

#### Actuating travel

5.8 mm ± 0.2 mm

#### Rebound time

≤1 ms

#### Mechanical lifetime

(with 1 switching element)

Pushbutton maintained action 1.5 million Cycles of operation

Pushbutton momentary action 3 million Cycles of operation

Selector switch maintained action 1.25 million Cycles of operation

Selector switch momentary action 2.5 million Cycles of operation

Emergency-stop switch 50 000 Cycles of operation

Keylock switch maintained action 25 000 Cycles of operation

Keylock switch momentary action 50 000 Cycles of operation

### Electrical characteristics

#### Standards

The switches comply with EN IEC 60947-1 / EN IEC 60947-5-1

#### Rated Insulation Voltage $U_i$

500 VAC / 600 VDC, as per EN IEC 60947-5-1

#### Contact resistance

New state ≤50 mΩ as per DIN IEC 60512-2-4

#### Isolation resistance

≥10 MΩ between open contacts at 500 VDC, as per DIN IEC 60512-2-10

### Electrical life

50 000 cycles of operations

### Conventional free air thermal current $I_{th}$

6 A, as per EN IEC 60947-5-1

the maximum current in continuous operation and at ambient temperature must not exceed the quoted maximum values.

### Switch rating

At switch rating AC for gold-silver and hardsilver contacts, service category AC-15, as per EN IEC 60947-5-1 (cosφ 0.3)

Voltage 250 VAC

Current 6 A

At switch rating DC for gold-silver and hardsilver contacts, service category DC-13, as per EN IEC 60947-5-1

Voltage 24 VDC 110 VDC

Current 6 A 1.0 A

### Recommended minimum operational data

Gold-silver contacts:

Voltage 24 VDC

Current 5 mA

Hardsilver contacts:

Voltage 24 VDC

Current 50 mA

### Protection class

Indicators and switches, fit for mounting into devices with protection class II

### Approvals

#### Approbations

CB (IEC 60947)

CCC

CSA

Germanischer Lloyd

GOST

NFF 16-102

#### Declaration of conformity

CE

## Lamp block PIT

### Material

#### Housing

Polycarbonate (PC)

### Mechanical characteristics

#### Terminals

PIT Spring terminal

Skinning 8 mm

Wire cross-section:

Wire 0.2 to 1.0 mm<sup>2</sup> Stranded wire 0.2 to 1.0 mm<sup>2</sup> without core and sleeve

Stranded wire 0.2 to 0.75 mm<sup>2</sup> with core and sleeve

### Electrical characteristics

#### Standards

The switches comply with EN IEC 60947-1 / EN IEC 60947-5-1

## Illumination

Voltage 250 V max.  
Power 2.6 W max.  
BA9s standard adaptable.

## Environmental conditions

### Storage temperature

-40 °C ... +85 °C

### Operating temperature

-40 °C ... +55 °C

### Protection degree

IP 20

### Shock resistance

(single impacts, semi-sinusoidal)  
300 m/s<sup>2</sup>puls width 11 ms, as per EN IEC 60068-2-27

### Vibration resistance

(sinusoidal)  
100 m/s<sup>2</sup> at 10 Hz ... 500 Hz, as per EN IEC 60068-2-6 and EN 61373 Increased broad band noise, class 1B

## Buzzer

## Buzzer system

### System

Piezo disc

## Material

### Alarm buzzer case

Polyamide

### Front cap

Plastic Polyamide  
Metal Nickel-plated brass (sea-water proof)

## Mechanical characteristics

### Terminals

Plug-in terminal 2.8 x 0.5 mm

## Electrical characteristics

### Frequency (tone)

approx. 2.8 kHz continuous tone only

### Sound pressure

95 db (A) ±8 dB at a distance of 0.1 m

### Operation Voltage/Current

Operation Voltage 24 VDC ±10 %  
Operation Current ≤25 mA

## Environmental conditions

### Storage temperature

-40 °C ... +85 °C

### Operating temperature

-25 °C ... +55 °C

### Protection degree

as per EN IEC 60529, frontside

IP 40, devices flush mounting

IP 65, devices raised mounting

## Approvals

### Declaration of conformity

CE

## Actuator

## Material

### Front ring

Polyamide, Aluminium or Stainless steel

### Mounting flange

Polyethylene terephthalate

### Actuator housing

Polycarbonate, Polyamide

## Mechanical characteristics

### Actuating force

Mounting style square flush 6.2 N  
other Mounting styles 8 N

### Actuating travel

5.8 mm ± 0.2 mm

### Mechanical lifetime

(with 1 switching element)

|                     |              |                     |
|---------------------|--------------|---------------------|
| Pushbutton          | ≤3 million   | Cycles of operation |
| Selector switch     | ≤2.5 million | Cycles of operation |
| Stop switch         | ≤50 000      | Cycles of operation |
| Fool proofed E-stop | ≥6050        | Cycles of operation |
| Keylock switch      | ≤50 000      | Cycles of operation |
| Key insert switches | ≤250 000     | Cycles of operation |

## Electrical characteristics

### Standards

The switches comply with the "Rules for low-voltage switching devices" EN IEC 60947-5-1

## Environmental conditions

### Storage temperature

-40 °C ... +85 °C

### Operating temperature

-25 °C ... +55 °C  
-40 °C ... +55 °C (Key insert switch)

### Protection degree

as per EN IEC 60529  
frontside IP 65 (IP 67 Key insert switch)

## Rotary selector switch element

## Mechanical characteristics

### Terminals

Screw terminals  
Terminal lead material copper wires only  
max. permissible wire gage :  
Single-core or stranded wire 2 x 1.5 mm<sup>2</sup> (2 x AWG 14)  
flexible wire 2 x 1,5 mm<sup>2</sup> (2 x AWG 16)

## Number of stages

1 to 8 positions max.

## Number of contacts

1 to 16 max. normally open contacts  
(contact positioning according circuit drawing)

## Switching angle

Basic position of switching position "a" is 9 o'clock

Maintained action    Switching angle

12 max.                30 °

8 max.                 45 °

6 max.                 60 °

4 max.                 90 °

Momentary action with release 24 °

(provide at the beginning or at the end )

## Standard type of Kraus & Naimer

CG4 Hard Silver contacts with 1 µm Gold layer

CG4-1 Hard Silver contacts with 35 µm Gold layer

## Electrical characteristics

### Minimum Voltage

20 V

### Rated Impulse Withstand Voltage $U_{imp}$

4 kV

### Short Circuit Protection

Max. fuse size (gL- characteristic) 10 A

Rated short-time withstand current (1s-current) 90 A

## Electrical characteristics for AC

### Standards

The devices comply with : EN IEC 60947-3, VDE 0660 part 107

### Rated Operational Voltage $U_e$

440 V

### Rated Insulation Voltage $U_i$

440 V

### Rated Thermal Current $I_U/I_{th}$

10 A

### Rated Operational Current $I_e$

AC-15 Switching of control devices, contactors, valves etc.

110 V - 120 V    2.5 A

220 V - 240 V    2.5 A

380 V - 440 V    1.5 A

No load operation

10 A

AC-21A Switching of resistive loads, including moderate overloads

For switchin of power >1 kW

10 A

AC-22A Switching of combined resistive or low inductive loads including moderate overloads

220 V - 240 V    10 A

### Rated Utilization Category

AC-2 Slip ring motor starting, reversing and plugging, star-delta starting 3 phase, 3 pole

220 V - 240 V    2.5 kW

380 V - 440 V    4.5 kW

AC-3 Direct-on-line starting, star-delta starting

3 phase, 3 pole    220 V - 240 V    2.5 kW

380 V - 440 V    2.2 kW

1 phase, 2 pole    110 V - 120 V    0.3 kW

220 V - 240 V    0.55 kW

380 V - 440 V    0.75 kW

AC-Direct-on-line starting, reversing, plugging and inching

3 phase, 3 pole    220 V - 240 V    0.37 kW

380 V - 440 V    0.55 kW

1 phase, 2 pole    110 V - 120 V    0.15 kW

220 V - 240 V    0.25 kW

380 V - 440 V    0.5 kW

AC-23A Frequent switching of motors or other high inductive loads

3 phase, 3 pole    220 V - 240 V    1.8 kW

380 V - 440 V    3 kW

1 phase, 2 pole    110 V - 120 V    0.37 kW

220 V - 240 V    0.75 kW

380 V - 440 V    1.1 kW

### Overvoltage category

III, valid for lines with grounded common neutral termination

### Degree of pollution

3, valid for lines with grounded common neutral termination

## Electrical characteristics for AC (UL/Canada)

### Rated operational voltage

300 V

### Rated Insulation Voltage $U_i$

300 V

### Rated Thermal Current

10 A

### Ampere Rating

Resistive or low inductive loads, for switching of power >1 kW, 10 A

### Ratings

Standard motor load, DOL Rating (similar AC-3)

3 phase, 3 pole    110 V - 120 V    0.75 HP

220 V - 240 V    1 HP

1 phase, 2 pole    110 V - 120 V    0.33 HP

220 V - 240 V    0.75 HP

277 V - 277 V    0.75 HP

### Pilot Duty, Heavy

300 VAC

## Electrical characteristics for DC

### Switch Rating DC

Resistive loads  $T \leq 1$  ms

Number of series contact(s)

| 1    | 2    | 3    | 4    | 5     | 6     | 8     | Switch Capacity |
|------|------|------|------|-------|-------|-------|-----------------|
| 24 V | 48 V | 70 V | 95 V | 120 V | 145 V | 190 V | 10 A            |

|       |       |       |       |       |       |       |       |
|-------|-------|-------|-------|-------|-------|-------|-------|
| 48 V  | 95 V  | 140 V | 190 V | 240 V | 290 V | 350 V | 6 A   |
| 60 V  | 120 V | 180 V | 240 V | 300 V | 360 V | 450 V | 2.5 A |
| 110 V | 220 V | 330 V | 440 V | 550 V | 660 V |       | 0.7 A |
| 220 V | 440 V | 660 V |       |       |       |       | 0.3 A |
| 440 V | 660 V |       |       |       |       |       | 0.2 A |

Inductive loads T = 50 ms

| Number of series contact(s) |       |       |       |       |       |       | Switch   |
|-----------------------------|-------|-------|-------|-------|-------|-------|----------|
| 1                           | 2     | 3     | 4     | 5     | 6     | 8     | Capacity |
| 24 V                        | 48 V  | 70 V  | 95 V  | 120 V | 145 V | 190 V | 6 A      |
| 30 V                        | 60 V  | 90 V  | 120 V | 150 V | 180 V | 240 V | 3 A      |
| 48 V                        | 95 V  | 140 V | 190 V | 240 V | 290 V | 350 V | 1 A      |
| 60 V                        | 120 V | 180 V | 240 V | 300 V | 360 V | 450 V | 0.7 A    |
| 110 V                       | 220 V | 330 V | 440 V | 550 V | 660 V |       | 0.3 A    |

## Environmental conditions

### Operating temperature

Ambient Temperatures of Stages

|                            |  |
|----------------------------|--|
| open at 100 % $I_U/I_{th}$ | 55 °C during 24 h with peaks up to 60 °C |
| enclosed at 100 % $I_{th}$ | 35 °C during 24 h with peaks up to 40 °C |

## Flasher element

Do not connect terminal c and f simultaneously when powered up.



## Suppressor circuits

When switching inductive loads such as relays, DC motors, and DC solenoids, it is always important to absorb surges (e.g. with a diode) to protect the contacts. When these inductive loads are switched off, a counter emf can severely damage switch contacts and greatly shorten lifetime.

Fig. 1 shows an inductive load with a free-wheeling diode connected in parallel. This free-wheeling diode provides a path for the inductor current to flow when the current is interrupted by the switch. Without this free-wheeling diode, the voltage across the coil will be limited only by dielectric breakdown voltages of the circuit or parasitic elements of the coil. This voltage can be kilovolts in amplitude even when nominal circuit voltages are low (e.g. 12 VDC) see Fig. 2.

The free-wheeling diode should be chosen so that the reverse breakdown voltage is greater than the voltage driving the inductive load. The DC blocking voltage ( $V_R$ ) of the free-wheeling diode can be found in the datasheet of a diode. The forward current should be equal or greater than the maximum current flowing through the load.

**To get an efficient protection, the free-wheeling diode must be connected as close as possible to the inductive load!**

Switching with inductive load  
Fig. 1



Counter emf  
over load without free-wheeling diode  
Fig. 2



## General notes

### 1. Engraving

In addition to the most commonly used world languages, in DIN 1451-3 close spacing, other typefaces are available as Scandinavian, Slavic, Greek, Russian and Polish.

The lenses are filled with black or white colour. Standard height of letters is 3 mm. If the height is not specified, we will supply 3 mm engraved letters.

### 2. Hot stamping

Standard legends and ISO symbols are hot stamped. For larger series it is worth considering markings by means of hot stamping. We will be pleased to advise you.

### 3. Film inserts

Instead of using engraving the square lenses can be fitted with film inserts, as an alternative. Film thickness is 0.25 mm.

Max. film size :

for Indicator 24.5 mm x 24.5 mm

for illuminated Pushbutton 21.5 x 21.5 mm.

## Engraving marking cap for Indicator round, full face illumination

All dimensions in mm

| Height of letters | Number of lines | Number of (target value) letters per line |    |    | Line spacing |
|-------------------|-----------------|---|----|----|--------------|
|                   |                 | b1  | b2 | b3 | d            |
| 3                 | 3               | 11  | 10 | 9  | 4.6          |
| 4                 | 2               | 8   | 7  | -  | 6.6          |
| 8                 | 1               | 4   | -  | -  | -            |

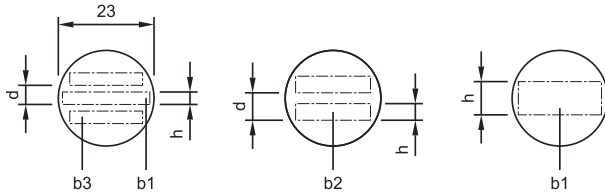

The gap between 2 words results in each case a letter less.

## Engraving marking cap for Indicator and illuminated Pushbutton round, front illumination

All dimensions in mm

| Height of letters | Number of lines | Number of (target value) letters per line |    |    | Line spacing |
|-------------------|-----------------|---|----|----|--------------|
|                   |                 | b1  | b2 | b3 | d            |
| 3                 | 3               | 9   | 9  | 7  | 4.6          |
| 4                 | 2               | 7   | 6  | -  | 6.6          |
| 8                 | 1               | 3   | -  | -  | -            |



The gap between 2 words results in each case a letter less.



## Engraving diffusor cap for Indicator square, full face illumination

All dimensions in mm

| Height of letters<br>h | Number of lines | Number of (target value)<br>capital letters per line | Number of (target value)<br>small letters per line |
|------------------------|-----------------|--|--|
| 2.5                    | 6               | 13   | 14   |
| 3.0                    | 5               | 11   | 12   |
| 4.0                    | 4               | 8  | 8 - 9  |
| 5.0                    | 3               | 6 - 7  | 7  |
| 6.0                    | 2               | 5 - 6  | 6  |
| 8.0                    | 1               | 4  | 4 - 5  |



The gap between 2 words results in each case a letter less.

## Engraving lens holder for Indicator and Illuminate Pushbutton square, front illumination

All dimensions in mm

| Height of letters<br>h | Number of lines | Number of (target value)<br>capital letters per line | Number of (target value)<br>small letters per line |
|------------------------|-----------------|--|--|
| 2.5                    | 5               | 9  | 9 - 10   |
| 3.0                    | 4               | 7 - 8  | 8  |
| 4.0                    | 3               | 5 - 6  | 6  |
| 5.0                    | 2               | 4 - 5  | 4 - 5  |
| 6.0                    | 2               | 3 - 4  | 4  |
| 8.0                    | 1               | 2 - 3  | 3  |



The gap between 2 words results in each case a letter less.

Important : Consider lens holder mounting orientation before specifying engraving characters !

## Engraving legend plates

All dimensions in mm

| Dimension | Devices mounting style | Height of letters h | Number of lines | Number of (target value) letters per line | Image |
|-----------|------------------------|---------------------|-----------------|---|-------|
| 30 x 50   | round, raised          | 3                   | 2               | 12  | B1    |
|           |                        | 4                   | 1               | 7   | B1    |
|           |                        | 8                   | 1               | 4   | B1    |
| 35 x 57.5 | round, flush           | 3                   | 2               | 12  | B2    |
|           |                        | 4                   | 1               | 7   | B2    |
|           |                        | 8                   | 1               | 4   | B2    |
| 18 x 35   | square, flush          | 3                   | 3               | 16  | B3    |
|           |                        | 4                   | 2               | 10  | B3    |
|           |                        | 8                   | 1               | 6   | B3    |



The gap between 2 words results in each case a letter less.

## Standard texts for marking plates and marking caps for Indicator and Illuminated Pushbutton

Height of letters 6 mm



## Symbols for marking plates and marking caps for Indicator and Illuminated Pushbutton

|   |   |   |   |   |  |   |  |
|---|---|---|---|---|--|---|--|
|    | 1 Direction of linear rectilinear motion (also for $\rightarrow \updownarrow$ ) |    | 13 Direction of spindle rotation                    |    | 29 Decrease of value (speed, for instance)                     |    | 49 Cooling pump                        |
|    | 2 Linear motion in 2 directions (also for $\updownarrow$ )                      |    | 14 One revolution                                   |    | 30 Speed of planing cut  |    | 50 Lubricant pump                      |
|    | 3 Interrupted linear motion (also for $\leftarrow \updownarrow$ )               |    | 15 Number of revolutions per minute (spindle speed) |    | 31 Speed of turning cut  |    | 51 Hydraulic system pump               |
|    | 4 Limited linear motion (also for $\leftarrow \updownarrow$ )                   |    | 16 Feed   |    | 32 Speed of drilling cut                                       |    | 52 Hydraulic motor                     |
|    | 5 Limited linear motion and return  |    | 17 Feed per revolution                              |    | 33 Speed of milling cut (similar symbol for speed of grinding) |    | 53 Tracer                              |
|    | 6 Oscillating linear motion (continuous)  |    | 18 Feed per minute                                  |    | 34 Conventional milling  |    | 61 Stepless regulation                 |
|   | 7 Direction of continuous rotation (right)                                      |   | 19 Reduced feed                                     |   | 35 Climb milling (down milling)                                |   | 62 Adjustable                          |
|  | 7a Direction of continuous rotation (left)                                      |  | 20 Rapid feed                                       |  | 41 Electric motor  |  | 63.1 Lock or tighten                   |
|  | 8 Rotation in 2 directions  |  | 21 Normal feed                                      |  | 42 Rectangular work table or slide element                     |  | 63.2 Lock or tighten                   |
|  | 9 Direction of interrupted rotation (right)                                     |  | 22 Direction of feed (orientation not specified)    |  | 43 Round work table or rotating element                        |  | 64.1 Unlock, unclamp                   |
|  | 9a Direction of interrupted rotation (left)                                     |  | 24 Transverse feed                                  |  | 44 Turning spindle   |  | 64.2 Chuck open                        |
|  | 10 Limited rotation (right)   |  | 25 Vertical feed                                    |  | 45 Drilling spindle  |  | 65 Brake on                            |
|  | 10a Limited rotation (left)   |  | 26 Rapid traverse                                   |  | 46 Milling spindle   |  | 66 Brake off                           |
|  | 11 Limited rotation and return  |  | 27 Threading  |  | 47 Grinding spindle  |  | 67 Automatic (or semi-automatic) cycle |
|  | 12 Oscillating rotary movement (continuous)                                     |  | 28 Increase of value (speed, for instance)          |  | 48 Pump (general symbol)                                       |  | 68 Hand control                        |

Continuation see next page

Continued from previous page



69 Start, on



77 Open lock-nut



93 Caution!



106 Drain



70 Stop, off



78 Engage sensor



94 Main switch



107 Oil, lubricant



71 Start and stop with same button



79 Disengage sensor



101 Coolant fluid



108 Blast



72 In action as long as button is operated



80 Change speed only in stopped position



102 Machine lighting



109 Suction



74 Engaging (mechanical start)



81 Change speed only in motion



103 Weight



75 Disengaging (mechanical stop)



91 Shear pin construction



104 Filter opening



76 Close lock-nut



92 Danger (high voltage)



105 Overflow

## Mounting dimensions

1 Rotary selector switch actuator, short lever, flush mounting page 44 | Rotary selector switch actuator, long lever, flush mounting page 44



2 Emergency-stop pushbutton actuator, foolproof EN IEC 60947-5-5 page 21



3 Indicator full-face illumination compact page 12



Hole spacing 31 mm min. by using blind plug 704.960.4

4 Rotary selector switch actuator, short lever page 31 | Rotary selector switch actuator, long lever page 31



5 Indicator full face illumination page 13 | Indicator front illumination page 14 | Flasher full face illumination page 15 | Flasher front illumination page 16 | Buzzer page 17 | Pushbutton actuator page 18 | Illuminated pushbutton actuator page 20 | Keylock switch actuator 2 positions page 25 | Keylock switch actuator 3 positions page 26 | Selector switch actuator 2 positions, short lever page 27 | Selector switch actuator 2 positions, short lever, 12 o'clock page 27 | Selector switch actuator 3 positions, short lever page 29



Hole spacing 31 mm min. by using blind plug 704.960.4

6 Selector switch actuator 2 positions, long lever page 28 | Selector switch actuator 2 positions, long lever, 12 o'clock page 28 | Selector switch actuator 3 positions, long lever page 30



7 Indicator, flush mounting page 32 | Flasher, flush mounting page 33 | Buzzer, flush mounting page 33 | Pushbutton actuator, flush mounting page 34 | Illuminated pushbutton actuator, flush mounting page 36 | Keylock switch actuator 2 positions, flush mounting page 38 | Keylock switch actuator 3 positions, flush mounting page 39 | Selector switch actuator 2 positions, short lever, flush mounting page 40 | Selector switch actuator 2 positions, short lever, 12 o'clock, flush mounting page 40 | Selector switch actuator 2 positions, long lever, flush mounting page 41 | Selector switch actuator 2 positions, long lever, 12 o'clock, flush mounting page 41 | Selector switch actuator 3 positions, short lever, flush mounting page 42 | Keylock rotary switch actuator, flush mounting page 45 | Front bezel set for Indicator and Pushbutton, flush mounting page 68 | Front bezel set for Indicator and Pushbutton, flush mounting page 73



8 Selector switch actuator 3 positions, long lever, flush mounting page 43



**9 Stop pushbutton actuator** page 22 | **Mushroom-head pushbutton actuator** page 23 | **Mushroom-head pushbutton actuator illuminated** page 24



**10 Stop pushbutton actuator, flush mounting** page 37 | **Mushroom-head pushbutton actuator, flush mounting** page 37



**11 Key insert switch actuator 2 positions, flush mounting** page 45 | **Key insert switch actuator 3 positions, flush mounting** page 46



**12 Indicator, flush mounting** page 32 | **Flasher, flush mounting** page 33 | **Pushbutton actuator, flush mounting** page 34 | **Illuminated pushbutton actuator, flush mounting** page 36 | **Keylock switch actuator 2 positions, flush mounting** page 38 | **Keylock switch actuator 3 positions, flush mounting** page 39 | **Selector switch actuator 2 positions, short lever, flush mounting** page 40 | **Selector switch actuator 2 positions, short lever, 12 o'clock, flush mounting** page 40 | **Selector switch actuator 3 positions, short lever, flush mounting** page 42



13 Selector switch actuator 2 positions, long lever, flush mounting page 41 | Selector switch actuator 2 positions, long lever, 12 o'clock, flush mounting page 41 | Selector switch actuator 3 positions, long lever, flush mounting page 43



14 Rotary selector switch actuator, short lever, flush mounting page 44 | Rotary selector switch actuator, long lever, flush mounting page 44



15 Key insert switch actuator 3 positions Conductor Switch, flush mounting page 46





## Technical drawing

1 Key insert switch actuator 2 positions, flush mounting page 45 | Key insert switch actuator 3 positions, flush mounting page 46



2 Indicator full-face illumination compact page 12



3 Indicator full face illumination page 13



## 4 Pushbutton actuator page 18



## 5 Indicator front illumination page 14



## 6 Flasher full face illumination page 15



## 7 Flasher front illumination page 16



## 8 Illuminated pushbutton actuator page 20



## 9 Keylock switch actuator 2 positions page 25 | Keylock switch actuator 3 positions page 26

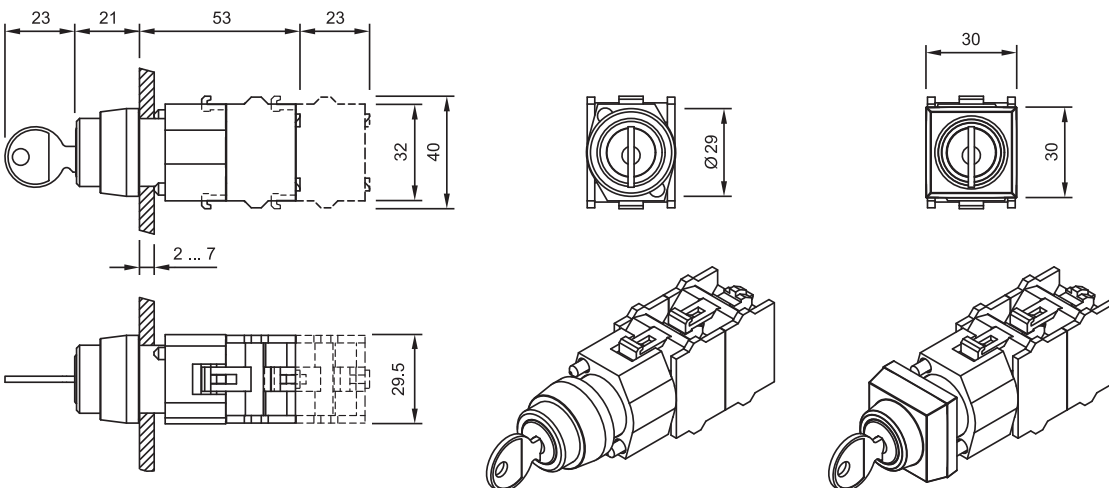

10 Selector switch actuator 2 positions, long lever page 28 | Selector switch actuator 2 positions, long lever, 12 o'clock page 28 | Selector switch actuator 3 positions, long lever page 30



11 Selector switch actuator 2 positions, short lever page 27 | Selector switch actuator 2 positions, short lever, 12 o'clock page 27 | Selector switch actuator 3 positions, short lever page 29



12 Stop pushbutton actuator page 22



**13 Mushroom-head pushbutton actuator illuminated** page 24



**14 Emergency-stop pushbutton actuator, foolproof EN IEC 60947-5-5** page 21



**15 Mushroom-head pushbutton actuator** page 23



**16 Selector switch actuator 2 positions, long lever, flush mounting page 41 | Selector switch actuator 2 positions, long lever, 12 o'clock, flush mounting page 41 | Selector switch actuator 3 positions, long lever, flush mounting page 43**



**17 Stop pushbutton actuator page 22**



**18 Buzzer page 17**



## 19 Illuminated pushbutton actuator, flush mounting page 36



## 20 Indicator, flush mounting page 32

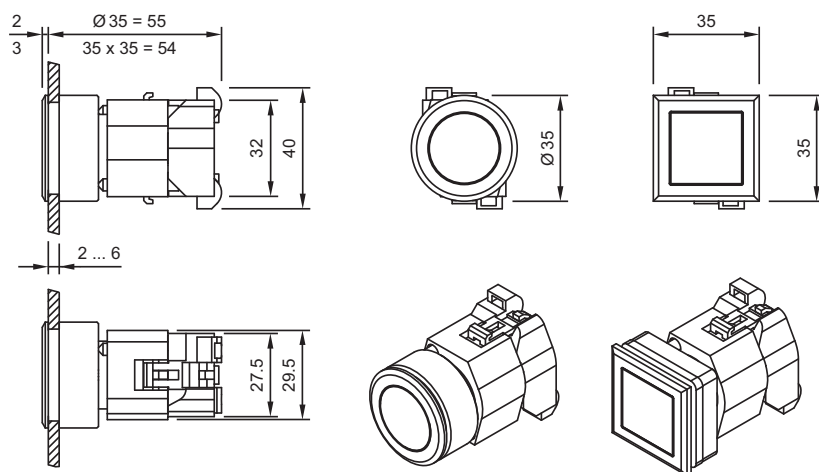

## 21 Flasher, flush mounting page 33



## 22 Pushbutton actuator, flush mounting page 34



## 23 Selector switch actuator 2 positions, short lever, flush mounting page 40 | Selector switch actuator 2 positions, short lever, 12 o'clock, flush mounting page 40 | Selector switch actuator 3 positions, short lever, flush mounting page 42 | Selector switch actuator 3 positions, long lever, flush mounting page 43



## 24 Emergency-stop pushbutton actuator, foolproof EN IEC 60947-5-5 page 21





**25 Keylock switch actuator 2 positions, flush mounting page 38 | Keylock switch actuator 3 positions, flush mounting page 39**



**26 Stop pushbutton actuator, flush mounting page 37**



**27 Mushroom-head pushbutton actuator, flush mounting page 37**



**28 Switching element page 51 | Switching element for Emergency-stop pushbutton page 54**

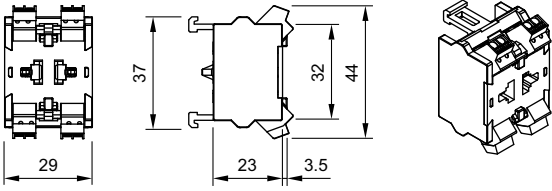

**29 Switching element page 51 | Switching element for ring cable shoe page 53 | Switching element for Emergency-stop pushbutton page 54**

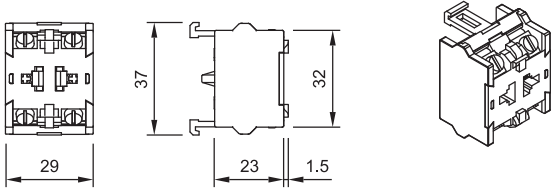

**30 Switching element page 51 | Switching element for Emergency-stop pushbutton page 54**

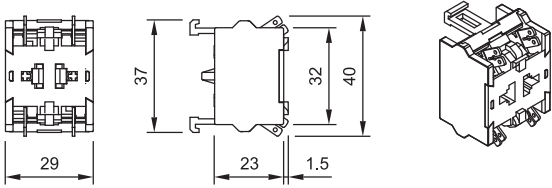

**31 Switching element page 51 | Switching element for Emergency-stop pushbutton page 54**

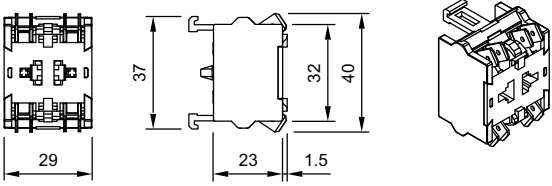

**32 Flasher element page 50**

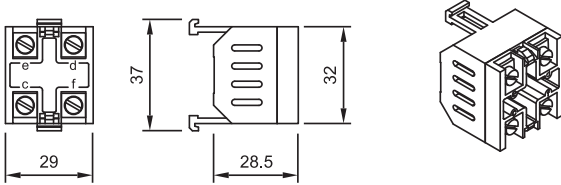

**33 Lamp transformer page 59**

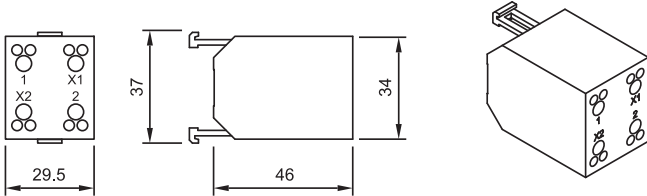

**34 Diode block page 58 | Resistor block page 59 | Resistor-diode block page 59**

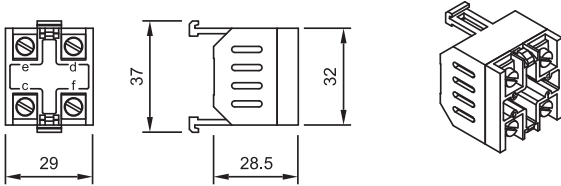

**35 Terminal cover** page 56



**36 Mounting plate** page 61



**37 Snap-on base** page 62



**38 Snap-on base** page 62



**39 Lamp block** page 65 | **Lamp block** page 67 | **Lamp block** page 70 | **Lamp block** page 71 | **Lamp block** page 74 | **Lamp block** page 76



**40 Lamp block** page 65 | **Lamp block** page 67 | **Lamp block** page 70 | **Lamp block** page 71 | **Lamp block** page 74 | **Lamp block** page 76



**41 Lamp block** page 65 | **Lamp block** page 67 | **Lamp block** page 70 | **Lamp block** page 71 | **Lamp block** page 74 | **Lamp block** page 76



42 Lamp block page 65 | Lamp block page 67 | Lamp block page 70 | Lamp block page 71 | Lamp block page 74 | Lamp block page 76



43 Blind plug page 49



44 Blind plug page 49



45 Blind plug page 49



46 Blind plug page 49



47 Bayonet flange page 65 | Bayonet flange page 66 | Bayonet flange page 69 | Bayonet flange page 71 | Bayonet flange page 74 | Bayonet flange page 76



**48 Bayonet flange** page 65 | **Bayonet flange** page 66 | **Bayonet flange** page 69 | **Bayonet flange** page 71 | **Bayonet flange** page 74 | **Bayonet flange** page 76



**49 Protective cover** page 48



Front panel thickness reduces by 3.5 mm to max. 4.5 mm

**50 Protective cover, flush mounting** page 49

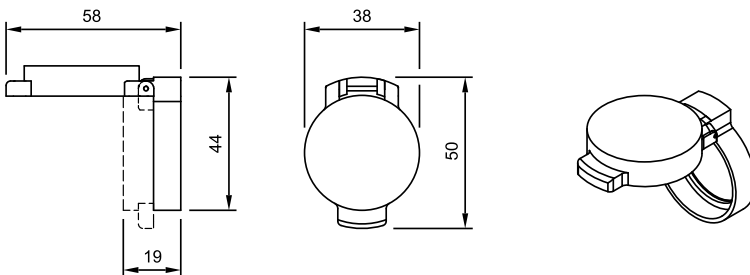

Front panel thickness reduces by 2.5 mm to max. 3.5 mm

**51 Protective cover** page 48



Front panel thickness reduces by 3.5 mm to max. 4.5 mm

## 52 Protective cover, flush mounting page 49



Front panel thickness reduces by 2.5 mm to max. 3.5 mm

## 53 Protective cover, flush mounting page 49

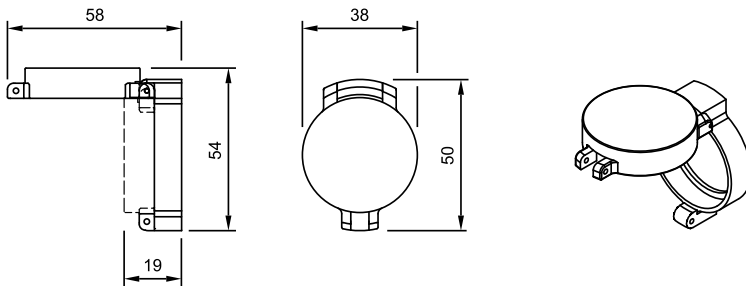

Front panel thickness reduces by 2.5 mm to max. 3.5 mm

## 54 Protective cover, flush mounting page 49



## 55 Legend frame page 48



**56 Key insert switch actuator 3 positions Conductor Switch, flush mounting page 46**



**57 Reducing ring page 61**



**58 Emergency-stop protective shroud page 60**



**59 Emergency-stop protective shroud page 60**



60 Legend frame page 48



61 Emergency-stop enclosures page 60



62 Emergency-stop enclosures page 60





63 Emergency-stop enclosures page 60 | Enclosure page 63



64 Enclosure page 63



65 Enclosure page 63



66 Enclosure page 63



67 Enclosure page 63

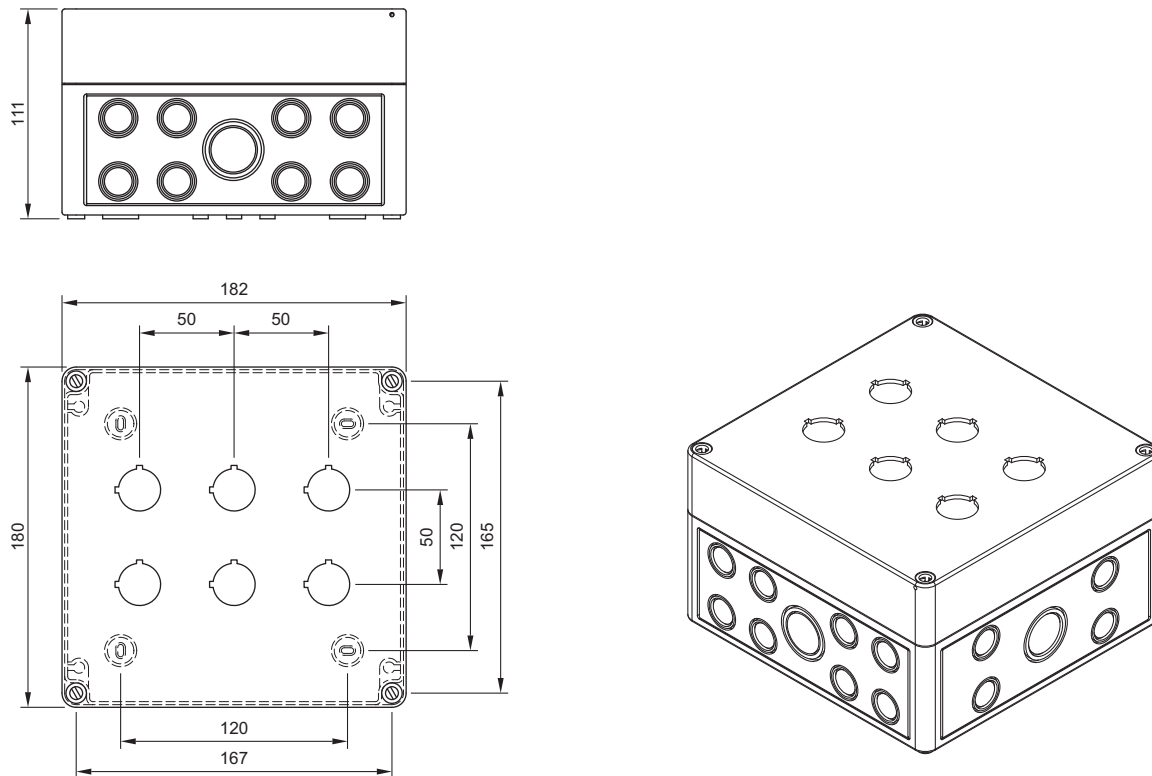

68 Buzzer, flush mounting page 33



**69 Rotary selector switch actuator, short lever page 31**



**70 Rotary selector switch actuator, long lever page 31**



**71 Rotary selector switch actuator, short lever, flush mounting page 44**



## 72 Rotary selector switch actuator, long lever, flush mounting page 44

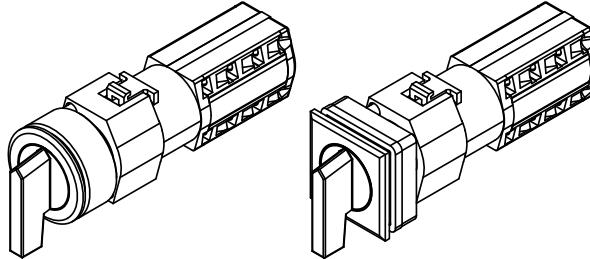

| Stages | L     |
|--------|-------|
| 1      | 78.5  |
| 2      | 90.5  |
| 3      | 102.5 |
| 4      | 114.5 |
| 5      | 126.5 |
| 6      | 138.5 |
| 7      | 150.5 |
| 8      | 162.5 |

## 73 Keylock rotary switch actuator, flush mounting page 45

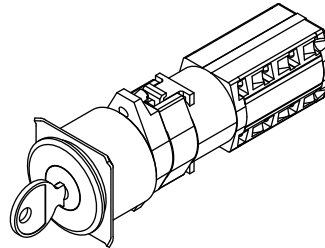

| Stages | L     |
|--------|-------|
| 1      | 85.5  |
| 2      | 97.5  |
| 3      | 109.5 |
| 4      | 121.5 |
| 5      | 133.5 |
| 6      | 145.5 |
| 7      | 157.5 |
| 8      | 169.5 |

## Circuit drawing

### 1 Buzzer page 17 | Buzzer, flush mounting page 33



### 2 Diode block page 58



### 3 Pushbutton actuator page 18 | Mushroom-head pushbutton actuator page 23 | Pushbutton actuator, flush mounting page 34 | Illuminated pushbutton actuator, flush mounting page 36 | Mushroom-head pushbutton actuator, flush mounting page 37



### 4 Pushbutton actuator page 18 | Mushroom-head pushbutton actuator page 23 | Pushbutton actuator, flush mounting page 34 | Illuminated pushbutton actuator, flush mounting page 36 | Mushroom-head pushbutton actuator, flush mounting page 37



**5 Indicator full-face illumination compact** page 12 | **Indicator full face illumination** page 13 | **Indicator front illumination** page 14 | **Flasher full face illumination** page 15 | **Flasher front illumination** page 16 | **Indicator, flush mounting** page 32 | **Flasher, flush mounting** page 33 | **Indicator actuator for Indicator compact** page 64 | **Lamp block** page 65 | **Lamp block** page 67 | **Lamp block** page 70 | **Lamp block** page 71 | **Lamp block** page 74 | **Lamp block** page 76



**6 Emergency-stop pushbutton actuator, foolproof EN IEC 60947-5-5** page 21 | **Stop pushbutton actuator** page 22 | **Stop pushbutton actuator, flush mounting** page 37



**7 Switching element** page 51 | **Switching element for ring cable shoe** page 53 | **Switching element for Emergency-stop pushbutton** page 54



**8 Switching element** page 51 | **Switching element for ring cable shoe** page 53 | **Switching element for Emergency-stop pushbutton** page 54



**9 Lamp transformer** page 59



**10 Resistor block** page 59



**11 Resistor-diode block** page 59



### 12 Flasher element page 50



### 13 Rotary selector switching element 30° page 55



### 14 Rotary selector switching element 30° page 55



### 15 Rotary selector switching element 30° page 55

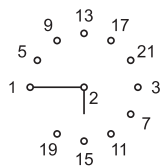

### 16 Rotary selector switching element 30° page 55



### 17 Rotary selector switching element 45° page 55

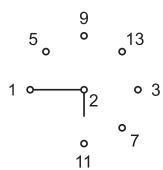

### 18 Rotary selector switching element 45° page 55

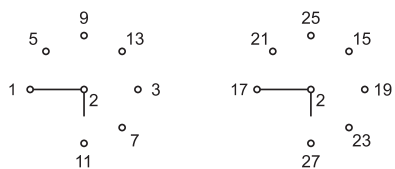

**19 Rotary selector switching element 45° page 55**



**20 Rotary selector switching element 45° page 55**



**21 Rotary selector switching element 60° page 56**



**22 Rotary selector switching element 60° page 56**



**23 Rotary selector switching element 60° page 56**



**24 Rotary selector switching element 60° page 56**



**25 Rotary selector switching element 60° page 56**



**26 Rotary selector switching element 60° page 56**



**27 Rotary selector switching element 60° page 56**



**28 Rotary selector switching element 60° page 56**





**29 Rotary selector switching element 60° page 56**



**30 Rotary selector switching element 60° page 56**



**31 Rotary selector switching element 60° page 56**



**32 Rotary selector switching element 60° page 56**



**33 Rotary selector switching element 60° page 56**



**34 Illuminated pushbutton actuator page 20 | Mushroom-head pushbutton actuator illuminated page 24 | Illuminated pushbutton actuator, flush mounting page 36**



**35 Selector switch actuator 3 positions, short lever page 29 | Selector switch actuator 3 positions, long lever page 30 | Selector switch actuator 3 positions, short lever, flush mounting page 42 | Selector switch actuator 3 positions, long lever, flush mounting page 43**



**36 Selector switch actuator 3 positions, short lever page 29 | Selector switch actuator 3 positions, long lever page 30 | Selector switch actuator 3 positions, short lever, flush mounting page 42 | Selector switch actuator 3 positions, long lever, flush mounting page 43**



**37 Selector switch actuator 2 positions, short lever page 27 | Selector switch actuator 2 positions, long lever page 28 | Selector switch actuator 2 positions, short lever, flush mounting page 40 | Selector switch actuator 2 positions, long lever, flush mounting page 41**



**38 Selector switch actuator 2 positions, short lever page 27 | Selector switch actuator 2 positions, short lever, 12 o'clock page 27 | Selector switch actuator 2 positions, long lever page 28 | Selector switch actuator 2 positions, long lever, 12 o'clock page 28 | Selector switch actuator 2 positions, short lever, flush mounting page 40 | Selector switch actuator 2 positions, short lever, 12 o'clock, flush mounting page 40 | Selector switch actuator 2 positions, long lever, flush mounting page 41 | Selector switch actuator 2 positions, long lever, 12 o'clock, flush mounting page 41**



**39 Selector switch actuator 3 positions, short lever** page 29 | **Selector switch actuator 3 positions, long lever** page 30 | **Selector switch actuator 3 positions, short lever, flush mounting** page 42 | **Selector switch actuator 3 positions, long lever, flush mounting** page 43



**40 Selector switch actuator 3 positions, short lever** page 29 | **Selector switch actuator 3 positions, long lever** page 30 | **Selector switch actuator 3 positions, short lever, flush mounting** page 42 | **Selector switch actuator 3 positions, long lever, flush mounting** page 43



**41 Illuminated pushbutton actuator** page 20 | **Mushroom-head pushbutton actuator illuminated** page 24 | **Illuminated pushbutton actuator, flush mounting** page 36



**42 Keylock switch actuator 3 positions** page 26 | **Keylock switch actuator 3 positions, flush mounting** page 39



**43 Keylock switch actuator 3 positions** page 26 | **Keylock switch actuator 3 positions, flush mounting** page 39



**44 Keylock switch actuator 2 positions** page 25 | **Keylock switch actuator 2 positions, flush mounting** page 38



**45 Keylock switch actuator 2 positions** page 25 | **Keylock switch actuator 2 positions, flush mounting** page 38



**46 Keylock switch actuator 3 positions** page 26 | **Keylock switch actuator 3 positions, flush mounting** page 39



**47 Keylock switch actuator 3 positions** page 26 | **Keylock switch actuator 3 positions, flush mounting** page 39



**48 Switching element** page 51 | **Switching element for ring cable shoe** page 53 | **Switching element for Emergency-stop pushbutton** page 54



**49 Switching element** page 51 | **Switching element for ring cable shoe** page 53 | **Switching element for Emergency-stop pushbutton** page 54



50 Switching element page 51 | Switching element for ring cable shoe page 53 | Switching element for Emergency-stop pushbutton page 54



51 Indicator full-face illumination compact page 12



# Index from Typ-Nr.

| Typ-Nr.      | Page | Typ-Nr.     | Page | Typ-Nr.     | Page |
|--------------|------|-------------|------|-------------|------|
| 02-912.1     | 59   | 704.000.7   | 13   | 704.009.2   | 18   |
| 02-912.2     | 59   | 704.000.7   | 15   | 704.009.4   | 18   |
| 02-912.3     | 59   | 704.001.2   | 13   | 704.009.5   | 18   |
| 02-912.4     | 59   | 704.001.2   | 15   | 704.009.6   | 18   |
| 10-1406.1369 | 57   | 704.001.4   | 13   | 704.009.7   | 18   |
| 10-1409.1329 | 57   | 704.001.4   | 15   | 704.010.0   | 18   |
| 10-1412.1279 | 57   | 704.001.5   | 13   | 704.010.2   | 18   |
| 10-1416.1289 | 57   | 704.001.5   | 15   | 704.010.4   | 18   |
| 10-1419.1249 | 57   | 704.001.6   | 13   | 704.010.5   | 18   |
| 10-1420.1219 | 57   | 704.001.6   | 15   | 704.010.6   | 18   |
| 10-1422.1179 | 57   | 704.001.7   | 13   | 704.010.7   | 18   |
| 10-1424.1179 | 57   | 704.001.7   | 15   | 704.011.0   | 19   |
| 10-2506.1082 | 58   | 704.002.2   | 14   | 704.011.018 | 35   |
| 10-2506.1084 | 58   | 704.002.2   | 16   | 704.011.2   | 19   |
| 10-2506.1085 | 58   | 704.002.4   | 14   | 704.011.218 | 35   |
| 10-2506.1086 | 58   | 704.002.4   | 16   | 704.011.4   | 19   |
| 10-2506.1089 | 58   | 704.002.5   | 14   | 704.011.418 | 35   |
| 10-2509.1142 | 58   | 704.002.5   | 16   | 704.011.5   | 19   |
| 10-2509.1144 | 58   | 704.002.6   | 14   | 704.011.518 | 35   |
| 10-2509.1145 | 58   | 704.002.6   | 16   | 704.011.6   | 19   |
| 10-2509.1146 | 58   | 704.002.7   | 14   | 704.011.618 | 35   |
| 10-2509.1149 | 58   | 704.002.7   | 16   | 704.011.8   | 19   |
| 10-2512.1142 | 58   | 704.003.2   | 14   | 704.011.818 | 35   |
| 10-2512.1144 | 58   | 704.003.2   | 16   | 704.012.0   | 19   |
| 10-2512.1145 | 58   | 704.003.4   | 14   | 704.012.018 | 35   |
| 10-2512.1146 | 58   | 704.003.4   | 16   | 704.012.2   | 19   |
| 10-2512.1149 | 58   | 704.003.5   | 14   | 704.012.218 | 35   |
| 10-2513.1142 | 58   | 704.003.5   | 16   | 704.012.4   | 19   |
| 10-2513.1144 | 58   | 704.003.6   | 14   | 704.012.418 | 35   |
| 10-2513.1145 | 58   | 704.003.6   | 16   | 704.012.5   | 19   |
| 10-2513.1146 | 58   | 704.003.7   | 14   | 704.012.518 | 35   |
| 10-2513.1149 | 58   | 704.003.7   | 16   | 704.012.6   | 19   |
| 10-2519.1052 | 58   | 704.006.2   | 14   | 704.012.618 | 35   |
| 10-2519.1054 | 58   | 704.006.2   | 16   | 704.012.7   | 19   |
| 10-2519.1055 | 58   | 704.006.218 | 32   | 704.012.718 | 35   |
| 10-2519.1056 | 58   | 704.006.218 | 33   | 704.013.0   | 19   |
| 10-2519.1059 | 58   | 704.006.4   | 14   | 704.013.2   | 19   |
| 10-2H24.2052 | 58   | 704.006.4   | 16   | 704.013.4   | 19   |
| 10-2H24.2054 | 58   | 704.006.418 | 32   | 704.013.5   | 19   |
| 10-2H24.2055 | 58   | 704.006.418 | 33   | 704.013.6   | 19   |
| 10-2H24.2056 | 58   | 704.006.5   | 14   | 704.013.7   | 19   |
| 10-2H24.2059 | 58   | 704.006.5   | 16   | 704.020.2   | 12   |
| 10-2H25.2042 | 58   | 704.006.518 | 32   | 704.020.4   | 12   |
| 10-2H25.2044 | 58   | 704.006.518 | 33   | 704.020.5   | 12   |
| 10-2H25.2045 | 58   | 704.006.6   | 14   | 704.020.6   | 12   |
| 10-2H25.2046 | 58   | 704.006.6   | 16   | 704.020.7   | 12   |
| 10-2H25.2049 | 58   | 704.006.618 | 32   | 704.021.2   | 12   |
| 14-810.002   | 17   | 704.006.618 | 33   | 704.021.4   | 12   |
| 14-810.902   | 17   | 704.006.7   | 14   | 704.021.5   | 12   |
| 14-810.910   | 33   | 704.006.7   | 16   | 704.021.6   | 12   |
| 14-810.918   | 33   | 704.006.718 | 32   | 704.021.7   | 12   |
| 61-9481.6    | 61   | 704.006.718 | 33   | 704.022.2   | 12   |
| 61-9481.6    | 63   | 704.007.2   | 14   | 704.022.4   | 12   |
| 700.005.0    | 62   | 704.007.2   | 16   | 704.022.5   | 12   |
| 700.006.0    | 62   | 704.007.4   | 14   | 704.022.6   | 12   |
| 704.000.2    | 13   | 704.007.4   | 16   | 704.022.7   | 12   |
| 704.000.2    | 15   | 704.007.5   | 14   | 704.024.2   | 12   |
| 704.000.4    | 13   | 704.007.5   | 16   | 704.024.4   | 12   |
| 704.000.4    | 15   | 704.007.6   | 14   | 704.024.5   | 12   |
| 704.000.5    | 13   | 704.007.6   | 16   | 704.024.6   | 12   |
| 704.000.5    | 15   | 704.007.7   | 14   | 704.024.7   | 12   |
| 704.000.6    | 13   | 704.007.7   | 16   | 704.029.2   | 20   |
| 704.000.6    | 15   | 704.009.0   | 18   | 704.029.4   | 20   |

# Index from Typ-Nr.

| Typ-Nr.     | Page | Typ-Nr.     | Page | Typ-Nr.        | Page |
|-------------|------|-------------|------|----------------|------|
| 704.029.5   | 20   | 704.043.6   | 19   | 704.084.6      | 24   |
| 704.029.6   | 20   | 704.043.7   | 19   | 704.084.7      | 24   |
| 704.029.7   | 20   | 704.059.2   | 20   | 704.086.2      | 24   |
| 704.030.2   | 20   | 704.059.4   | 20   | 704.086.4      | 24   |
| 704.030.4   | 20   | 704.059.5   | 20   | 704.086.5      | 24   |
| 704.030.5   | 20   | 704.059.6   | 20   | 704.086.6      | 24   |
| 704.030.6   | 20   | 704.059.7   | 20   | 704.086.7      | 24   |
| 704.030.7   | 20   | 704.060.2   | 20   | 704.092.0      | 30   |
| 704.032.2   | 20   | 704.060.4   | 20   | 704.093.0      | 30   |
| 704.032.218 | 36   | 704.060.5   | 20   | 704.093.010    | 43   |
| 704.032.4   | 20   | 704.060.6   | 20   | 704.093.018    | 43   |
| 704.032.418 | 36   | 704.060.7   | 20   | 704.093.0x28   | 46   |
| 704.032.5   | 20   | 704.062.2   | 20   | 704.094.0      | 30   |
| 704.032.518 | 36   | 704.062.218 | 36   | 704.095.0      | 30   |
| 704.032.6   | 20   | 704.062.4   | 20   | 704.095.010    | 43   |
| 704.032.618 | 36   | 704.062.418 | 36   | 704.095.018    | 43   |
| 704.032.7   | 20   | 704.062.5   | 20   | 704.095.0T28   | 46   |
| 704.032.718 | 36   | 704.062.518 | 36   | 704.095.0x28   | 46   |
| 704.033.2   | 20   | 704.062.6   | 20   | 704.096.0      | 30   |
| 704.033.4   | 20   | 704.062.618 | 36   | 704.097.0      | 30   |
| 704.033.5   | 20   | 704.062.7   | 20   | 704.097.010    | 43   |
| 704.033.6   | 20   | 704.062.718 | 36   | 704.097.018    | 43   |
| 704.033.7   | 20   | 704.063.2   | 20   | 704.097.0x28   | 46   |
| 704.039.0   | 18   | 704.063.4   | 20   | 704.098.0      | 30   |
| 704.039.2   | 18   | 704.063.5   | 20   | 704.099.0      | 30   |
| 704.039.4   | 18   | 704.063.6   | 20   | 704.099.010    | 43   |
| 704.039.5   | 18   | 704.063.7   | 20   | 704.099.018    | 43   |
| 704.039.6   | 18   | 704.064.2   | 21   | 704.099.0x28   | 46   |
| 704.039.7   | 18   | 704.066.2   | 21   | 704.100.0      | 28   |
| 704.040.0   | 18   | 704.070.0   | 23   | 704.100.0.12   | 28   |
| 704.040.2   | 18   | 704.070.2   | 23   | 704.101.0      | 28   |
| 704.040.4   | 18   | 704.070.4   | 23   | 704.101.0.12   | 28   |
| 704.040.5   | 18   | 704.070.5   | 23   | 704.101.010    | 41   |
| 704.040.6   | 18   | 704.071.0   | 23   | 704.101.010.12 | 41   |
| 704.040.7   | 18   | 704.071.2   | 23   | 704.101.018    | 41   |
| 704.041.0   | 18   | 704.071.210 | 37   | 704.101.018.12 | 41   |
| 704.041.018 | 34   | 704.071.218 | 37   | 704.101.018KN  | 44   |
| 704.041.2   | 18   | 704.071.4   | 23   | 704.101.0D.12  | 28   |
| 704.041.218 | 34   | 704.071.410 | 37   | 704.101.0KN    | 31   |
| 704.041.4   | 18   | 704.071.418 | 37   | 704.101.0x28   | 45   |
| 704.041.418 | 34   | 704.071.5   | 23   | 704.101.110KN  | 44   |
| 704.041.5   | 18   | 704.072.0   | 23   | 704.101.118KN  | 44   |
| 704.041.518 | 34   | 704.072.2   | 23   | 704.101.1KN    | 31   |
| 704.041.6   | 18   | 704.072.4   | 23   | 704.102.0      | 28   |
| 704.041.618 | 34   | 704.072.5   | 23   | 704.103.0      | 28   |
| 704.041.8   | 18   | 704.073.0   | 23   | 704.103.018    | 41   |
| 704.041.818 | 34   | 704.073.2   | 23   | 704.103.0x28   | 45   |
| 704.042.0   | 18   | 704.073.210 | 37   | 704.113.0      | 26   |
| 704.042.018 | 34   | 704.073.4   | 23   | 704.113.018    | 39   |
| 704.042.2   | 18   | 704.073.5   | 23   | 704.114.0      | 26   |
| 704.042.218 | 34   | 704.074.2   | 22   | 704.114.018    | 39   |
| 704.042.4   | 18   | 704.074.210 | 37   | 704.115.0      | 26   |
| 704.042.418 | 34   | 704.074.3   | 22   | 704.115.018    | 39   |
| 704.042.5   | 18   | 704.075.2   | 22   | 704.116.0      | 26   |
| 704.042.518 | 34   | 704.075.218 | 37   | 704.116.018    | 39   |
| 704.042.6   | 18   | 704.075.3   | 22   | 704.117.0      | 26   |
| 704.042.618 | 34   | 704.075.310 | 37   | 704.117.018    | 39   |
| 704.042.7   | 18   | 704.075.318 | 37   | 704.118.0      | 26   |
| 704.042.718 | 34   | 704.076.0   | 22   | 704.118.018    | 39   |
| 704.043.0   | 19   | 704.078.0   | 22   | 704.120.0      | 25   |
| 704.043.2   | 19   | 704.084.2   | 24   | 704.120.018    | 38   |
| 704.043.4   | 19   | 704.084.4   | 24   | 704.121.0      | 25   |
| 704.043.5   | 19   | 704.084.5   | 24   | 704.121.018    | 38   |

# Index from Typ-Nr.

| Typ-Nr.       | Page | Typ-Nr.     | Page | Typ-Nr.     | Page |
|---------------|------|-------------|------|-------------|------|
| 704.122.0     | 25   | 704.206.2   | 14   | 704.229.700 | 36   |
| 704.122.018   | 38   | 704.206.2   | 16   | 704.230.2   | 20   |
| 704.123.0     | 25   | 704.206.200 | 32   | 704.230.208 | 36   |
| 704.123.018   | 38   | 704.206.200 | 33   | 704.230.4   | 20   |
| 704.123.018KN | 45   | 704.206.4   | 14   | 704.230.408 | 36   |
| 704.123.118KN | 45   | 704.206.4   | 16   | 704.230.5   | 20   |
| 704.124.0     | 26   | 704.206.400 | 32   | 704.230.508 | 36   |
| 704.124.018   | 39   | 704.206.400 | 33   | 704.230.6   | 20   |
| 704.151.XXX   | 47   | 704.206.5   | 14   | 704.230.608 | 36   |
| 704.152.XXX   | 47   | 704.206.5   | 16   | 704.230.7   | 20   |
| 704.153.XXX   | 47   | 704.206.500 | 32   | 704.230.708 | 36   |
| 704.154.XXX   | 47   | 704.206.500 | 33   | 704.239.0   | 18   |
| 704.155.XXX   | 47   | 704.206.6   | 14   | 704.239.000 | 34   |
| 704.199.2     | 13   | 704.206.6   | 16   | 704.239.2   | 18   |
| 704.199.2     | 15   | 704.206.600 | 32   | 704.239.200 | 34   |
| 704.199.4     | 13   | 704.206.600 | 33   | 704.239.4   | 18   |
| 704.199.4     | 15   | 704.206.7   | 14   | 704.239.400 | 34   |
| 704.199.5     | 13   | 704.206.7   | 16   | 704.239.5   | 18   |
| 704.199.5     | 15   | 704.206.700 | 32   | 704.239.500 | 34   |
| 704.199.6     | 13   | 704.206.700 | 33   | 704.239.6   | 18   |
| 704.199.6     | 15   | 704.207.2   | 14   | 704.239.600 | 34   |
| 704.199.7     | 13   | 704.207.2   | 16   | 704.239.7   | 18   |
| 704.199.7     | 15   | 704.207.4   | 14   | 704.239.700 | 34   |
| 704.200.2     | 13   | 704.207.4   | 16   | 704.240.0   | 18   |
| 704.200.2     | 15   | 704.207.5   | 14   | 704.240.008 | 34   |
| 704.200.4     | 13   | 704.207.5   | 16   | 704.240.2   | 18   |
| 704.200.4     | 15   | 704.207.6   | 14   | 704.240.208 | 34   |
| 704.200.5     | 13   | 704.207.6   | 16   | 704.240.4   | 18   |
| 704.200.5     | 15   | 704.207.7   | 14   | 704.240.408 | 34   |
| 704.200.6     | 13   | 704.207.7   | 16   | 704.240.5   | 18   |
| 704.200.6     | 15   | 704.209.0   | 18   | 704.240.508 | 34   |
| 704.200.7     | 13   | 704.209.000 | 34   | 704.240.6   | 18   |
| 704.200.7     | 15   | 704.209.2   | 18   | 704.240.608 | 34   |
| 704.202.2     | 14   | 704.209.200 | 34   | 704.240.7   | 18   |
| 704.202.2     | 16   | 704.209.4   | 18   | 704.240.708 | 34   |
| 704.202.208   | 32   | 704.209.400 | 34   | 704.259.2   | 20   |
| 704.202.208   | 33   | 704.209.5   | 18   | 704.259.200 | 36   |
| 704.202.4     | 14   | 704.209.500 | 34   | 704.259.4   | 20   |
| 704.202.4     | 16   | 704.209.6   | 18   | 704.259.400 | 36   |
| 704.202.408   | 32   | 704.209.600 | 34   | 704.259.5   | 20   |
| 704.202.408   | 33   | 704.209.7   | 18   | 704.259.500 | 36   |
| 704.202.5     | 14   | 704.209.700 | 34   | 704.259.6   | 20   |
| 704.202.5     | 16   | 704.210.0   | 18   | 704.259.600 | 36   |
| 704.202.508   | 32   | 704.210.008 | 34   | 704.259.7   | 20   |
| 704.202.508   | 33   | 704.210.2   | 18   | 704.259.700 | 36   |
| 704.202.6     | 14   | 704.210.208 | 34   | 704.260.2   | 20   |
| 704.202.6     | 16   | 704.210.4   | 18   | 704.260.208 | 36   |
| 704.202.608   | 32   | 704.210.408 | 34   | 704.260.4   | 20   |
| 704.202.608   | 33   | 704.210.5   | 18   | 704.260.408 | 36   |
| 704.202.7     | 14   | 704.210.508 | 34   | 704.260.5   | 20   |
| 704.202.7     | 16   | 704.210.6   | 18   | 704.260.508 | 36   |
| 704.202.708   | 32   | 704.210.608 | 34   | 704.260.6   | 20   |
| 704.202.708   | 33   | 704.210.7   | 18   | 704.260.608 | 36   |
| 704.203.2     | 14   | 704.210.708 | 34   | 704.260.7   | 20   |
| 704.203.2     | 16   | 704.229.2   | 20   | 704.260.708 | 36   |
| 704.203.4     | 14   | 704.229.200 | 36   | 704.292.0   | 30   |
| 704.203.4     | 16   | 704.229.4   | 20   | 704.292.000 | 43   |
| 704.203.5     | 14   | 704.229.400 | 36   | 704.292.008 | 43   |
| 704.203.5     | 16   | 704.229.5   | 20   | 704.294.0   | 30   |
| 704.203.6     | 14   | 704.229.500 | 36   | 704.294.000 | 43   |
| 704.203.6     | 16   | 704.229.6   | 20   | 704.294.008 | 43   |
| 704.203.7     | 14   | 704.229.600 | 36   | 704.296.0   | 30   |
| 704.203.7     | 16   | 704.229.7   | 20   | 704.296.000 | 43   |

# Index from Typ-Nr.

| Typ-Nr.        | Page | Typ-Nr.        | Page | Typ-Nr.      | Page |
|----------------|------|----------------|------|--------------|------|
| 704.296.008    | 43   | 704.409.010    | 42   | 704.601.2    | 72   |
| 704.298.0      | 30   | 704.409.018    | 42   | 704.601.21   | 73   |
| 704.298.000    | 43   | 704.410.0      | 27   | 704.601.4    | 72   |
| 704.298.008    | 43   | 704.410.0.12   | 27   | 704.601.41   | 73   |
| 704.300.0      | 28   | 704.411.0      | 27   | 704.601.5    | 72   |
| 704.300.0.12   | 28   | 704.411.0.12   | 27   | 704.601.51   | 73   |
| 704.300.000    | 41   | 704.411.010    | 40   | 704.601.6    | 72   |
| 704.300.000.12 | 41   | 704.411.010.12 | 40   | 704.601.61   | 73   |
| 704.300.008    | 41   | 704.411.010KN  | 44   | 704.601.8    | 72   |
| 704.300.008.12 | 41   | 704.411.018    | 40   | 704.601.81   | 73   |
| 704.300.100KN  | 44   | 704.411.018.12 | 40   | 704.601.9    | 72   |
| 704.300.108KN  | 44   | 704.411.0B.12  | 27   | 704.601.91   | 73   |
| 704.300.1KN    | 31   | 704.411.110KN  | 44   | 704.602.0    | 67   |
| 704.302.0      | 28   | 704.411.118KN  | 44   | 704.602.0    | 72   |
| 704.302.000    | 41   | 704.411.1KN    | 31   | 704.602.2    | 67   |
| 704.302.008    | 41   | 704.412.0      | 27   | 704.602.2    | 72   |
| 704.333.0      | 26   | 704.413.0      | 27   | 704.602.4    | 67   |
| 704.333.000    | 39   | 704.413.010    | 40   | 704.602.4    | 72   |
| 704.333.008    | 39   | 704.413.018    | 40   | 704.602.5    | 67   |
| 704.334.0      | 26   | 704.502.0      | 29   | 704.602.5    | 72   |
| 704.334.000    | 39   | 704.502.000    | 42   | 704.602.6    | 67   |
| 704.334.008    | 39   | 704.502.008    | 42   | 704.602.6    | 72   |
| 704.335.0      | 26   | 704.504.0      | 29   | 704.602.7    | 67   |
| 704.335.000    | 39   | 704.504.000    | 42   | 704.602.7    | 72   |
| 704.335.008    | 39   | 704.504.008    | 42   | 704.602.7A01 | 67   |
| 704.336.0      | 26   | 704.506.0      | 29   | 704.602.7A01 | 72   |
| 704.336.000    | 39   | 704.506.000    | 42   | 704.603.2    | 64   |
| 704.336.008    | 39   | 704.506.008    | 42   | 704.603.2    | 65   |
| 704.337.0      | 26   | 704.508.0      | 29   | 704.603.4    | 64   |
| 704.337.000    | 39   | 704.508.000    | 42   | 704.603.4    | 65   |
| 704.337.008    | 39   | 704.508.008    | 42   | 704.603.5    | 64   |
| 704.338.0      | 26   | 704.510.0      | 27   | 704.603.5    | 65   |
| 704.338.000    | 39   | 704.510.0.12   | 27   | 704.603.6    | 64   |
| 704.338.008    | 39   | 704.510.000    | 40   | 704.603.6    | 65   |
| 704.340.0      | 25   | 704.510.000.12 | 40   | 704.603.7    | 64   |
| 704.340.000    | 38   | 704.510.008    | 40   | 704.603.7    | 65   |
| 704.340.008    | 38   | 704.510.008.12 | 40   | 704.608.7    | 64   |
| 704.341.0      | 25   | 704.510.100KN  | 44   | 704.608.7    | 65   |
| 704.341.000    | 38   | 704.510.108KN  | 44   | 704.608.9    | 64   |
| 704.341.008    | 38   | 704.510.1KN    | 31   | 704.608.9    | 65   |
| 704.342.0      | 25   | 704.512.0      | 27   | 704.609.0    | 67   |
| 704.342.000    | 38   | 704.512.000    | 40   | 704.609.0    | 72   |
| 704.342.008    | 38   | 704.512.008    | 40   | 704.609.7    | 67   |
| 704.343.0      | 25   | 704.600.0      | 69   | 704.609.7    | 72   |
| 704.343.000    | 38   | 704.600.0      | 73   | 704.609.9    | 67   |
| 704.343.008    | 38   | 704.600.1      | 69   | 704.609.9    | 72   |
| 704.344.0      | 26   | 704.600.1      | 73   | 704.609.9A01 | 67   |
| 704.344.000    | 39   | 704.600.1A     | 69   | 704.609.9A01 | 72   |
| 704.344.008    | 39   | 704.600.1A     | 73   | 704.610.7    | 68   |
| 704.402.0      | 29   | 704.600.2      | 69   | 704.610.9    | 68   |
| 704.403.0      | 29   | 704.600.2      | 74   | 704.611.2    | 68   |
| 704.403.010    | 42   | 704.600.3      | 69   | 704.611.4    | 68   |
| 704.403.018    | 42   | 704.600.3      | 74   | 704.611.5    | 68   |
| 704.404.0      | 29   | 704.600.5/A    | 69   | 704.611.7    | 68   |
| 704.405.0      | 29   | 704.600.5/A    | 74   | 704.630.1    | 64   |
| 704.405.010    | 42   | 704.600.6      | 69   | 704.631.1    | 72   |
| 704.405.018    | 42   | 704.600.6      | 73   | 704.632.1    | 72   |
| 704.406.0      | 29   | 704.600.7      | 69   | 704.633.1    | 67   |
| 704.407.0      | 29   | 704.600.7      | 73   | 704.642.0    | 64   |
| 704.407.010    | 42   | 704.600.9      | 69   | 704.642.1    | 64   |
| 704.407.018    | 42   | 704.600.9      | 73   | 704.642.2    | 64   |
| 704.408.0      | 29   | 704.601.0      | 72   | 704.701.0    | 71   |
| 704.409.0      | 29   | 704.601.01     | 73   | 704.701.0    | 76   |

# Index from Typ-Nr.

| Typ-Nr.   | Page | Typ-Nr.     | Page | Typ-Nr.     | Page |
|-----------|------|-------------|------|-------------|------|
| 704.701.4 | 71   | 704.8A254   | 55   | 704.910.4   | 54   |
| 704.701.4 | 76   | 704.8A255   | 55   | 704.910.4B  | 53   |
| 704.701.6 | 71   | 704.8A270   | 56   | 704.910.5   | 51   |
| 704.701.6 | 76   | 704.8A271   | 56   | 704.910.5   | 54   |
| 704.702.0 | 75   | 704.8A272   | 56   | 704.910.5B  | 53   |
| 704.702.2 | 70   | 704.8A639   | 55   | 704.911.1   | 51   |
| 704.702.2 | 70   | 704.8A730   | 56   | 704.911.1   | 54   |
| 704.702.2 | 75   | 704.8A731   | 56   | 704.911.1B  | 53   |
| 704.702.4 | 70   | 704.900.1   | 52   | 704.911.2   | 51   |
| 704.702.4 | 70   | 704.900.1B  | 53   | 704.911.2   | 54   |
| 704.702.4 | 75   | 704.900.2   | 52   | 704.911.2B  | 53   |
| 704.702.5 | 70   | 704.900.2B  | 53   | 704.911.3   | 51   |
| 704.702.5 | 70   | 704.900.3   | 52   | 704.911.3   | 54   |
| 704.702.5 | 75   | 704.900.3B  | 53   | 704.911.3B  | 53   |
| 704.702.6 | 70   | 704.900.4   | 52   | 704.911.4   | 51   |
| 704.702.6 | 70   | 704.900.4B  | 53   | 704.911.4   | 54   |
| 704.702.6 | 75   | 704.900.5   | 52   | 704.911.4B  | 53   |
| 704.702.7 | 70   | 704.900.5B  | 53   | 704.911.5   | 51   |
| 704.702.7 | 70   | 704.901.1   | 52   | 704.911.5   | 54   |
| 704.702.7 | 75   | 704.901.1/D | 52   | 704.911.5B  | 53   |
| 704.702.9 | 75   | 704.901.2   | 52   | 704.912.1   | 51   |
| 704.703.2 | 66   | 704.901.2/D | 52   | 704.912.1   | 54   |
| 704.703.4 | 66   | 704.901.3   | 52   | 704.912.2   | 51   |
| 704.703.5 | 66   | 704.901.3/D | 52   | 704.912.2   | 54   |
| 704.703.6 | 66   | 704.901.4   | 52   | 704.912.3   | 51   |
| 704.703.7 | 66   | 704.901.4/D | 52   | 704.912.3   | 54   |
| 704.706.7 | 66   | 704.901.5   | 52   | 704.912.4   | 51   |
| 704.707.7 | 71   | 704.901.5/D | 52   | 704.912.4   | 54   |
| 704.707.7 | 75   | 704.902.1   | 52   | 704.912.5   | 51   |
| 704.708.7 | 66   | 704.902.2   | 52   | 704.912.5   | 54   |
| 704.708.9 | 66   | 704.902.3   | 52   | 704.915.1   | 51   |
| 704.709.7 | 70   | 704.902.4   | 52   | 704.915.1   | 54   |
| 704.709.7 | 75   | 704.902.5   | 52   | 704.915.1/D | 51   |
| 704.709.9 | 70   | 704.905.1   | 52   | 704.915.1/D | 54   |
| 704.709.9 | 75   | 704.905.1/D | 52   | 704.915.2   | 51   |
| 704.730.0 | 66   | 704.905.2   | 52   | 704.915.2   | 54   |
| 704.730.1 | 66   | 704.905.2/D | 52   | 704.915.2/D | 51   |
| 704.731.0 | 75   | 704.905.3   | 52   | 704.915.2/D | 54   |
| 704.731.1 | 75   | 704.905.3/D | 52   | 704.915.3   | 51   |
| 704.732.0 | 75   | 704.905.4   | 52   | 704.915.3   | 54   |
| 704.732.1 | 75   | 704.905.4/D | 52   | 704.915.3/D | 51   |
| 704.733.0 | 70   | 704.905.5   | 52   | 704.915.3/D | 54   |
| 704.733.1 | 70   | 704.905.5/D | 52   | 704.915.4   | 51   |
| 704.741.0 | 75   | 704.907.1   | 51   | 704.915.4   | 54   |
| 704.741.8 | 75   | 704.907.2   | 51   | 704.915.4/D | 51   |
| 704.742.0 | 75   | 704.907.3   | 51   | 704.915.4/D | 54   |
| 704.742.8 | 75   | 704.907.4   | 51   | 704.915.5   | 51   |
| 704.743.0 | 70   | 704.907.5   | 51   | 704.915.5   | 54   |
| 704.743.8 | 70   | 704.908.1   | 51   | 704.915.5/D | 51   |
| 704.8A230 | 56   | 704.908.2   | 51   | 704.915.5/D | 54   |
| 704.8A231 | 56   | 704.908.3   | 51   | 704.917.1   | 54   |
| 704.8A232 | 56   | 704.908.4   | 51   | 704.917.2   | 54   |
| 704.8A233 | 56   | 704.908.5   | 51   | 704.917.3   | 54   |
| 704.8A234 | 55   | 704.910.1   | 51   | 704.917.4   | 54   |
| 704.8A235 | 55   | 704.910.1   | 54   | 704.917.5   | 54   |
| 704.8A236 | 55   | 704.910.1B  | 53   | 704.918.1   | 54   |
| 704.8A237 | 55   | 704.910.2   | 51   | 704.918.2   | 54   |
| 704.8A238 | 55   | 704.910.2   | 54   | 704.918.3   | 54   |
| 704.8A239 | 55   | 704.910.2B  | 53   | 704.918.4   | 54   |
| 704.8A250 | 56   | 704.910.3   | 51   | 704.918.5   | 54   |
| 704.8A251 | 56   | 704.910.3   | 54   | 704.925.0   | 48   |
| 704.8A252 | 56   | 704.910.3B  | 53   | 704.925.2   | 48   |
| 704.8A253 | 56   | 704.910.4   | 51   | 704.925.3   | 48   |



# Index from Typ-Nr.

| Typ-Nr.     | Page | Typ-Nr.    | Page | Typ-Nr.     | Page |
|-------------|------|------------|------|-------------|------|
| 704.925.7   | 49   | 704.950.5  | 65   | 704.970.5   | 59   |
| 704.927.8   | 60   | 704.950.5  | 66   | 704.970.6   | 59   |
| 704.927.9   | 60   | 704.950.5  | 69   | 704.989.251 | 49   |
| 704.928.18  | 49   | 704.950.5  | 71   | 704.990.0   | 62   |
| 704.928.28  | 49   | 704.950.5  | 74   | 98-968      | 62   |
| 704.928.38  | 49   | 704.950.5  | 76   |             |      |
| 704.940.8   | 61   | 704.953.0  | 69   |             |      |
| 704.940.9   | 62   | 704.953.0  | 74   |             |      |
| 704.941.0   | 59   | 704.954.0  | 61   |             |      |
| 704.941.1   | 62   | 704.955.0  | 68   |             |      |
| 704.941.5   | 59   | 704.955.0  | 73   |             |      |
| 704.941.9   | 59   | 704.955.1  | 68   |             |      |
| 704.942.5   | 58   | 704.955.1  | 73   |             |      |
| 704.943.0   | 50   | 704.955.3  | 68   |             |      |
| 704.943.1   | 50   | 704.955.3  | 73   |             |      |
| 704.943.2   | 50   | 704.955.4  | 68   |             |      |
| 704.943.5   | 50   | 704.955.4  | 73   |             |      |
| 704.945.0   | 60   | 704.955.9  | 68   |             |      |
| 704.945.1   | 63   | 704.955.9  | 73   |             |      |
| 704.945.2   | 63   | 704.955.9E | 68   |             |      |
| 704.945.3   | 63   | 704.955.9E | 73   |             |      |
| 704.945.4   | 63   | 704.960.0  | 61   |             |      |
| 704.945.5   | 63   | 704.960.4  | 49   |             |      |
| 704.945.6   | 61   | 704.960.5  | 65   |             |      |
| 704.945.6   | 63   | 704.960.5  | 66   |             |      |
| 704.945.7   | 60   | 704.960.5  | 69   |             |      |
| 704.945.8   | 60   | 704.960.5  | 71   |             |      |
| 704.950.0   | 65   | 704.960.5  | 74   |             |      |
| 704.950.0   | 67   | 704.960.5  | 76   |             |      |
| 704.950.0   | 70   | 704.960.8  | 61   |             |      |
| 704.950.0   | 71   | 704.960.9  | 62   |             |      |
| 704.950.0   | 74   | 704.963.0  | 60   |             |      |
| 704.950.0   | 76   | 704.963.1  | 60   |             |      |
| 704.950.0B  | 65   | 704.963.2  | 60   |             |      |
| 704.950.0B  | 67   | 704.963.3  | 60   |             |      |
| 704.950.0B  | 70   | 704.963.5  | 60   |             |      |
| 704.950.0B  | 71   | 704.963.6  | 60   |             |      |
| 704.950.0B  | 74   | 704.963.7  | 60   |             |      |
| 704.950.0B  | 76   | 704.963.8  | 60   |             |      |
| 704.950.1   | 65   | 704.964.5  | 56   |             |      |
| 704.950.1   | 67   | 704.964.7  | 49   |             |      |
| 704.950.1   | 70   | 704.964.8  | 49   |             |      |
| 704.950.1   | 71   | 704.964.9  | 49   |             |      |
| 704.950.1   | 74   | 704.965.1  | 56   |             |      |
| 704.950.1   | 76   | 704.965.2  | 56   |             |      |
| 704.950.1/D | 65   | 704.965.3  | 56   |             |      |
| 704.950.1/D | 67   | 704.965.4  | 56   |             |      |
| 704.950.1/D | 70   | 704.965.5  | 56   |             |      |
| 704.950.1/D | 71   | 704.965.6  | 56   |             |      |
| 704.950.1/D | 74   | 704.965.7  | 56   |             |      |
| 704.950.1/D | 76   | 704.965.8  | 56   |             |      |
| 704.950.2/D | 65   | 704.965.9  | 56   |             |      |
| 704.950.2/D | 67   | 704.966.0  | 56   |             |      |
| 704.950.2/D | 70   | 704.966.1  | 56   |             |      |
| 704.950.2/D | 71   | 704.966.2  | 56   |             |      |
| 704.950.2/D | 74   | 704.968.0  | 48   |             |      |
| 704.950.2/D | 76   | 704.968.1  | 48   |             |      |
| 704.950.3   | 65   | 704.968.2  | 48   |             |      |
| 704.950.3   | 67   | 704.968.3  | 48   |             |      |
| 704.950.3   | 70   | 704.968.4  | 48   |             |      |
| 704.950.3   | 71   | 704.968.5  | 48   |             |      |
| 704.950.3   | 74   | 704.970.3  | 59   |             |      |
| 704.950.3   | 76   | 704.970.4  | 59   |             |      |

|                |   |
|----------------|---|
|                | <b>EAO AG</b>                                 |
|                | Tannwaldstrasse 88<br>4601 Olten, Switzerland |
| <b>E-mail</b>  | info@eao.com                                  |
| <b>Website</b> | www.eao.com                                   |
|                | <b>Austria</b>                                |
| Phone          | +49 201 85 87 0                               |
| Fax            | +49 201 85 87 210                             |
| E-mail         | sales.ede@eao.com                             |
|                | <b>Belgium</b>                                |
| Phone          | +32 3 777 82 36                               |
| Fax            | +32 3 777 84 19                               |
| E-mail         | sales.ebl@eao.com                             |
|                | <b>China</b>                                  |
| Phone          | +852 27 86 91 41                              |
| Fax            | +852 27 86 95 61                              |
| E-mail         | sales.ehk@eao.com                             |
|                | <b>France</b>                                 |
| Phone          | +33 1 64 43 37 37                             |
| Fax            | +33 1 64 43 37 49                             |
| E-mail         | sales.esa@eao.com                             |
|                | <b>Germany</b>                                |
| Phone          | +49 201 85 87 0                               |
| Fax            | +49 201 85 87 210                             |
| E-mail         | sales.ede@eao.com                             |
|                | <b>Italy</b>                                  |
| Phone          | +39 035 481 0189                              |
| Fax            | +39 035 481 3786                              |
| E-mail         | sales.eit@eao.com                             |
|                | <b>Japan</b>                                  |
| Phone          | +81 3 5444 5411                               |
| Fax            | +81 3 5444 0345                               |
| E-mail         | sales.esj@eao.com                             |
|                | <b>Netherlands</b>                            |
| Phone          | +31 78 653 17 00                              |
| Fax            | +31 78 653 17 99                              |
| E-mail         | sales.enl@eao.com                             |
|                | <b>Sweden</b>                                 |
| Phone          | +46 8 683 86 60                               |
| Fax            | +46 8 724 29 12                               |
| E-mail         | sales.esw@eao.com                             |
|                | <b>Switzerland</b>                            |
| Phone          | +41 62 388 95 00                              |
| Fax            | +41 62 388 95 55                              |
| E-mail         | sales.ech@eao.com                             |
|                | <b>United Kingdom</b>                         |
| Phone          | +44 1444 236 000                              |
| Fax            | +44 1444 236 641                              |
| E-mail         | sales.euk@eao.com                             |
|                | <b>USA</b>                                    |
| Phone          | +1 203 877 4577                               |
| Fax            | +1 203 877 3694                               |
| E-mail         | sales.eus@eao.com                             |
|                | <b>Other Countries</b>                        |
| Phone          | +41 62 286 92 10                              |
| Fax            | +41 62 296 21 62                              |
| E-mail         | info@eao.com                                  |



Компания «ЭлектроПласт» предлагает заключение долгосрочных отношений при поставках импортных электронных компонентов на взаимовыгодных условиях!

Наши преимущества:

- Оперативные поставки широкого спектра электронных компонентов отечественного и импортного производства напрямую от производителей и с крупнейших мировых складов;
- Поставка более 17-ти миллионов наименований электронных компонентов;
- Поставка сложных, дефицитных, либо снятых с производства позиций;
- Оперативные сроки поставки под заказ (от 5 рабочих дней);
- Экспресс доставка в любую точку России;
- Техническая поддержка проекта, помощь в подборе аналогов, поставка прототипов;
- Система менеджмента качества сертифицирована по Международному стандарту ISO 9001;
- Лицензия ФСБ на осуществление работ с использованием сведений, составляющих государственную тайну;
- Поставка специализированных компонентов (Xilinx, Altera, Analog Devices, Intersil, Interpoint, Microsemi, Aeroflex, Peregrine, Syfer, Eurofarad, Texas Instrument, Miteq, Cobham, E2V, MA-COM, Hittite, Mini-Circuits, General Dynamics и др.);

Помимо этого, одним из направлений компании «ЭлектроПласт» является направление «Источники питания». Мы предлагаем Вам помощь Конструкторского отдела:

- Подбор оптимального решения, техническое обоснование при выборе компонента;
- Подбор аналогов;
- Консультации по применению компонента;
- Поставка образцов и прототипов;
- Техническая поддержка проекта;
- Защита от снятия компонента с производства.



#### Как с нами связаться

**Телефон:** 8 (812) 309 58 32 (многоканальный)

**Факс:** 8 (812) 320-02-42

**Электронная почта:** [org@eplast1.ru](mailto:org@eplast1.ru)

**Адрес:** 198099, г. Санкт-Петербург, ул. Калинина, дом 2, корпус 4, литера А.