

LCC250

250 Watts

Convection/Conduction
Mounting

Total Power: 250 W
of Outputs: Single
Output: 12, 24, 48 V



Special Features

- 250W Full power at elevated temperatures
- Wide Operating Temperature Range suited for outdoor application
- IP64 Rated
- Conduction-cooled or convection
- Differential Remote Sense
- Output Adjust
- Output On/Off (Positive or Negative logic user selectable)

Compliance

- EMI Class B
- EN61000 Immunity
- MIL-STD-461E: CE101; CE102; CS101; CS114

Safety

- UL + CSA: 60950-1 2nd Ed.
60601-1 1st Ed.
ES 60601-1 (PENDING)
- TUV: 60950-1 2nd Ed.
60601-1 3rd Ed.
61347-1; 2-13
- CB Scheme: IEC 60950-1 2nd Ed
IEC 61347-1; 2-13
CCC⁵
- China
- CE Mark

Electrical Specifications

Input	
Input Range:	90 - 264 Vac (Operating) 115/230 Vac (Nominal)
Frequency:	47 - 63 Hz
Input Fusing:	Internal fuse on both L and N lines
Inrush Current:	50 A
Power Factor:	> 0.92 Full load
Harmonics:	Meets EN61000-3-2; MIL-STD-461E: CE101; CE102; CS101; CS104
Input Current:	3.4 A @ 90 Vac full load
Hold Up Time:	16 ms minimum at 115 Vac; 100% load 230 Vac; 100% load
Efficiency:	12 V - 89% typical 24 V - 91% typical 48 V - 91.5% typical
Leakage Current:	< 275 μ A at 230 Vac

Output		
Output Rating:	12 V @ 20.8 A 24 V @ 10.4 A 48 V @ 5.2 A	
Set Point:	± 0.2%	Factory set point
Total Regulation Range:	± 2%	Line/Load/Temperature
Rated Load:	250 W maximum	
Minimum Load:	0 A Load	No loss of regulation
Capacitive Load:	0 - 330 μ F/Amp	
Constant Output Voltage Adjustment Range:	12 V: +10 / -10% 24 V: +14.6 / -15% 48 V: +15% / -15%	Adjust via VR2
Constant Output Current Adjustment Range:	+0 / -50%	Adjust via VR1 CC mode supported from Vo nominal down to 80% Vo
Output Ripple and Noise:	1%	0 to 330 μ F/Amp
Transient Response:	± 5% Vo max transient; recovery < 500 μ s max	50% Load Step @ 1 A/ μ s Step Load verified at: 50% to 100% Load; 90 - 264 Vac input; Capacitive load from 0 to 330 μ F/Amp
Remote sense:	Capable of Stable Offset of ± 0.5 Vdc at output cable termination	+SENSE (Red Wire); -SENSE (Black Wire)
Output On/Off:	Remote On/Off referenced to secondary side. Positive or Negative logic user selectable via CN2. Factory default is Positive logic	On/Off (Orange Wire); On/Off Return (White Wire)
Overcurrent Protection (OCP):	≤ 150% Io	Auto-recovery
Overvoltage Protection (OVP):	110% to 135% Vo	Latching mode; Requires input AC recycle
Overtemperature Protection (OTP):		Auto-recovery; hiccup mode
Output Isolation	4000 Vac Input to Output 1500 Vac Input to Ground 500 Vac Output to Ground	

Environmental Specifications

Operating Temperature Range:	Suffix 4P (Conduction): -40 °C to +85 °C Baseplate Temperature Suffix 7P (Convection): -40 °C to +85 °C Ambient Temperature
Storage Temperature:	-40 °C to 85 °C
Humidity:	10% to 100% (Condensing & Non-Condensing)
Altitude:	Operating: 13,000 feet Non-Operating: 50,000 feet
Shock:	IEC68-2-27
Vibration:	IEC 68-2-6 / IEC 721-3-2
Ingress Protection:	IP64 Rated
MTBF (Calculated):	> 780,000 hours at 100% load; Low line; Telcordia SR-332

Ordering Information

Model Number	Output	Adjustment Range	Output Current		Output Ripple P/P ¹	Line/Load Regulation
			Min	Max		
LCC250-12U-4P	12 V	±10%	0 A	20.8 A	1% ²	± 2%
LCC250-12U-4PE	12 V	±10%	0 A	20.8 A	1% ²	± 2%
LCC250-12U-7P	12 V	±10%	0 A	20.8 A	1% ²	± 2%
LCC250-12U-7PE	12 V	±10%	0 A	20.8 A	1% ²	± 2%
LCC250-24U-4P	24 V	+14.6 / -15%	0 A	10.4 A	1% ³	± 2%
LCC250-24U-4PE	24 V	+14.6 / -15%	0 A	10.4 A	1% ³	± 2%
LCC250-24U-7P	24 V	+14.6 / -15%	0 A	10.4 A	1% ³	± 2%
LCC250-24U-7PE	24 V	+14.6 / -15%	0 A	10.4 A	1% ³	± 2%
LCC250-48U-4P	48 V	±15%	0 A	5.2 A	1% ⁴	± 2%
LCC250-48U-4PE	48 V	±15%	0 A	5.2 A	1% ⁴	± 2%
LCC250-48U-7P	48 V	±15%	0 A	5.2 A	1% ⁴	± 2%
LCC250-48U-7PE	48 V	±15%	0 A	5.2 A	1% ⁴	± 2%

- Output ripple measured at the end of the output cable terminated with 10 μ F tantalum cap in parallel with 0.1 μ F ceramic capacitor.
- 12V: 1% limit is achieved with 2X 820 μ F/16V external cap (e.g. PLG1C821MDO1 from Nichicon or equivalent). Otherwise, maximum limits are 1.5% at $T_a \geq 0^\circ\text{C}$ and 2.0% max at $T_a < 0^\circ\text{C}$.
- 24V: 1% limit is achieved with 2X 820 μ F/35V external cap (e.g. UPM1V821MHD1TO from Nichicon or equivalent). Otherwise, maximum limits are 1.5% at $T_a \geq -10^\circ\text{C}$. 2.0% max ripple at $T_a < -10^\circ\text{C}$ is met with below external capacitance:

Ambient Temperature ($^\circ\text{C}$)	-20	-25	-30	-35	-40
Recommended External Capacitors (μF)	1000	2200	3300	12000	22000
- 48V: 1% limit is achieved with 3X 470 μ F/63V external cap. Otherwise, maximum limits are 1.5% max at $T_a \geq 0^\circ\text{C}$ and 2% max at $T_a < 0^\circ\text{C}$.
- Safety Approvals: China CCC approval applies to part numbers with "-xxE" suffixes only.
- Warranty: 2 years

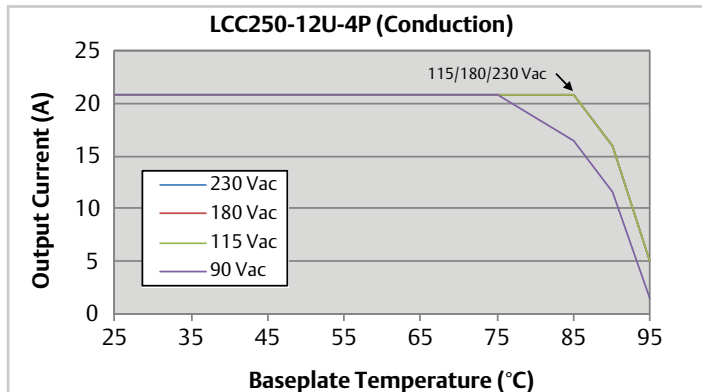

Fig 1. 12 V “4P” Suffix (Conduction) Output Current Derating

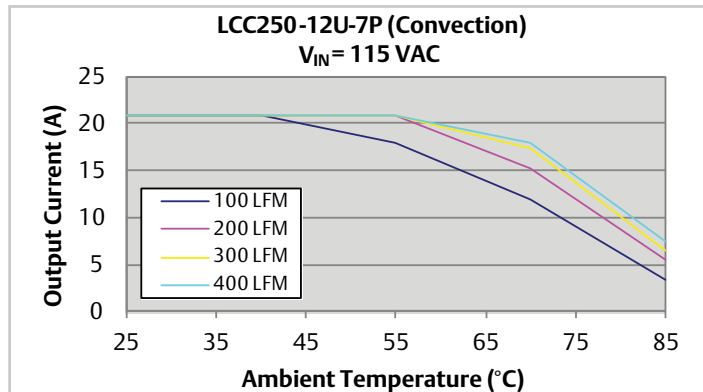

Fig 2. 12 V “7P” Suffix (Convection) Output Current Derating at 115 Vac

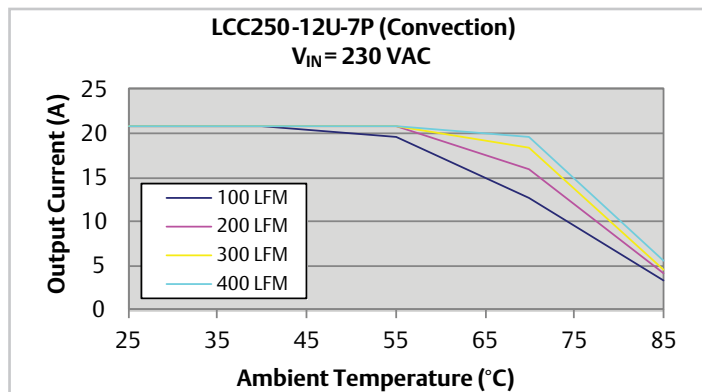

Fig 3. 12 V “7P” Suffix (Convection) Output Current Derating at 230 Vac

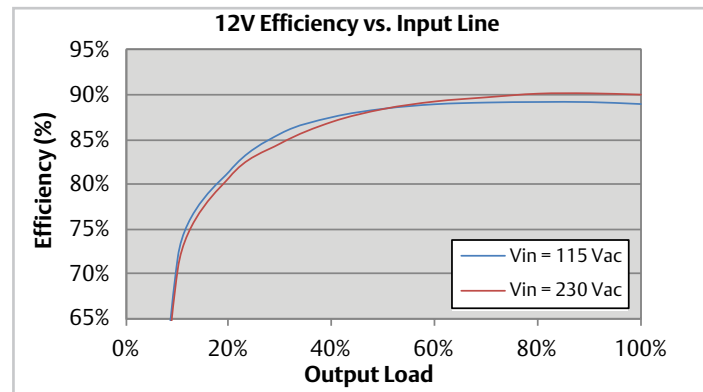

Fig 4. 12 V Efficiency Curve

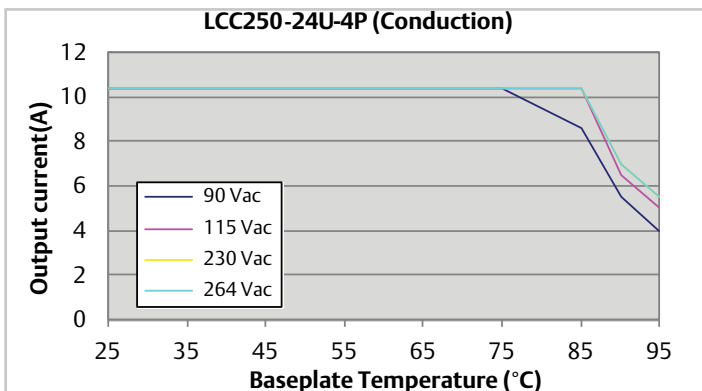

Fig 5. 24 V “4P” Suffix (Conduction) Output Current Derating

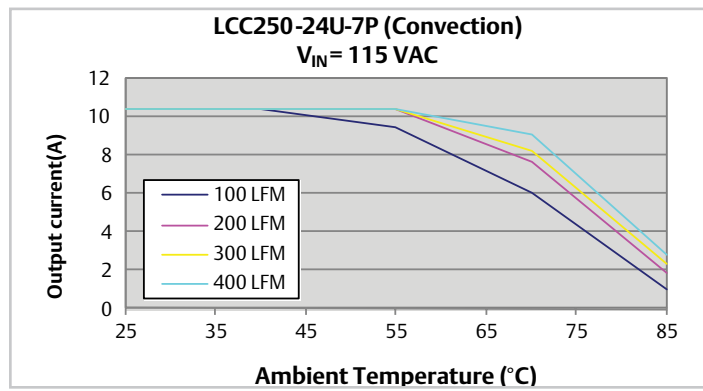

Fig 6. 24 V “7P” Suffix (Convection) Output Current Derating at 115 Vac

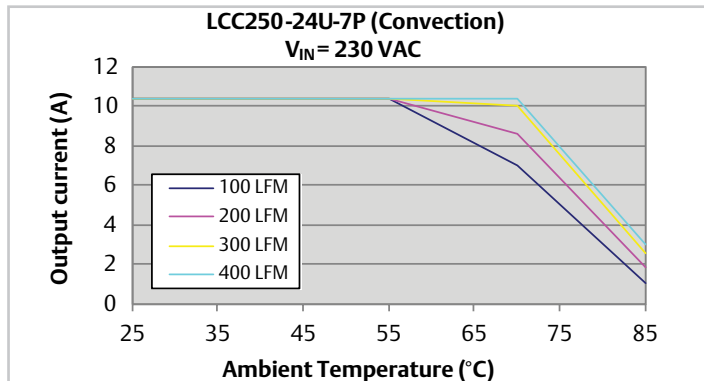

Fig 7. 24 V "7P" Suffix (Convection) Output Current Derating at 230 Vac

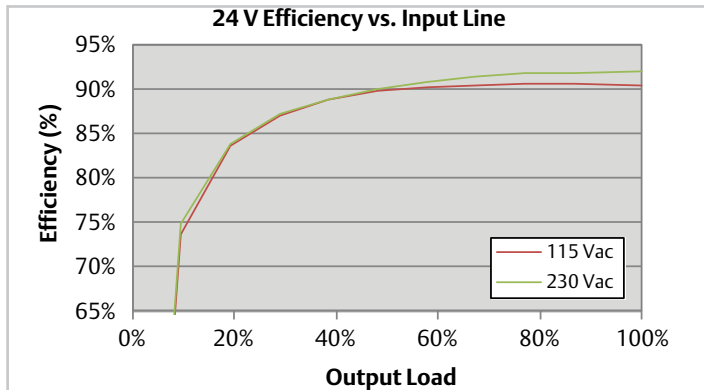

Fig 8. 24 V Efficiency Curve

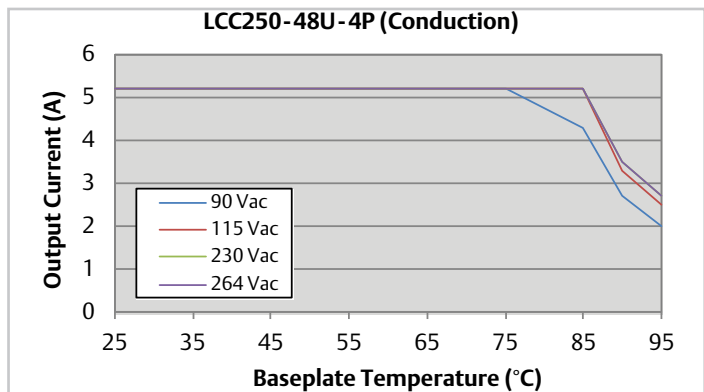

Fig 9. 48 V "4P" Suffix (Conduction) Output Current Derating

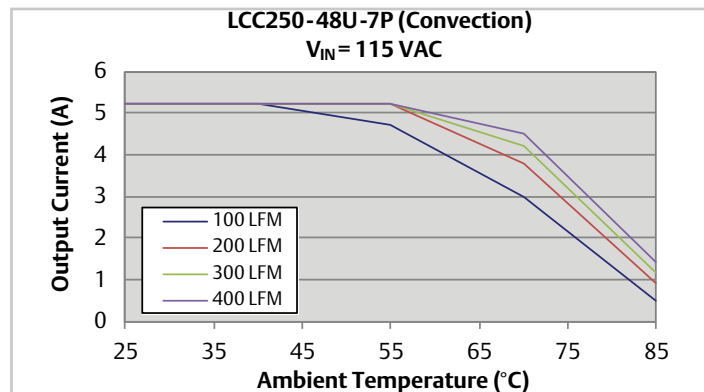

Fig 10. 48 V "7P" Suffix (Convection) Output Current Derating at 115 Vac

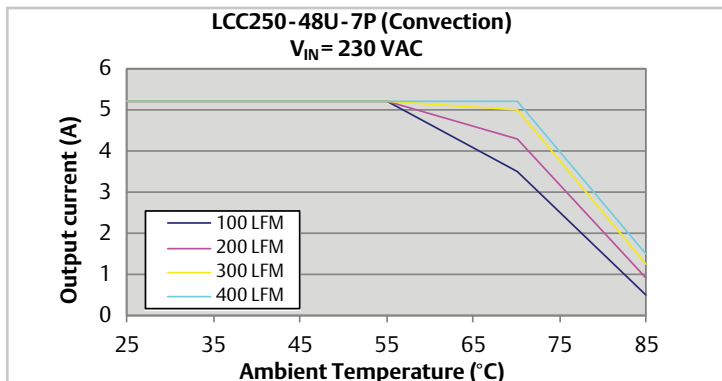

Fig 11. 48 V "7P" Suffix (Convection) Output Current Derating at 230 Vac

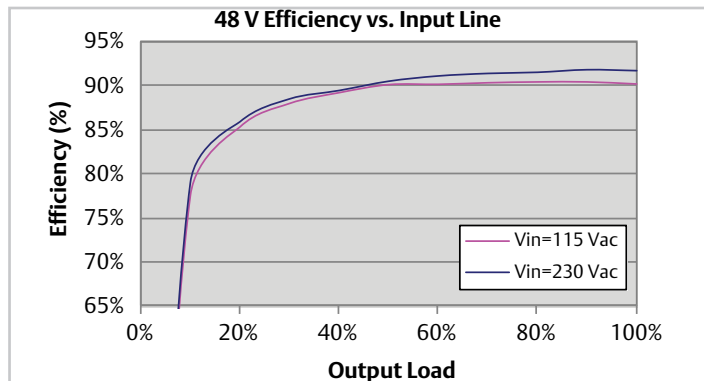
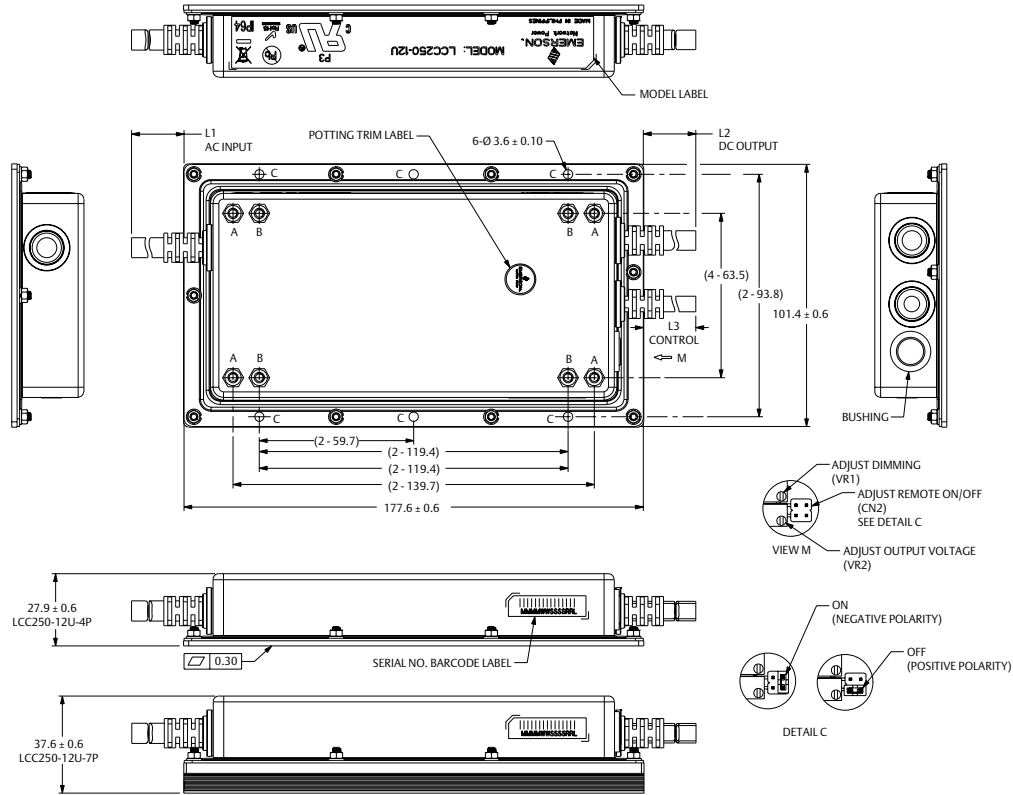

Fig 12. 48 V Efficiency Curve

Mechanical Drawings

12 V



24 V / 48 V

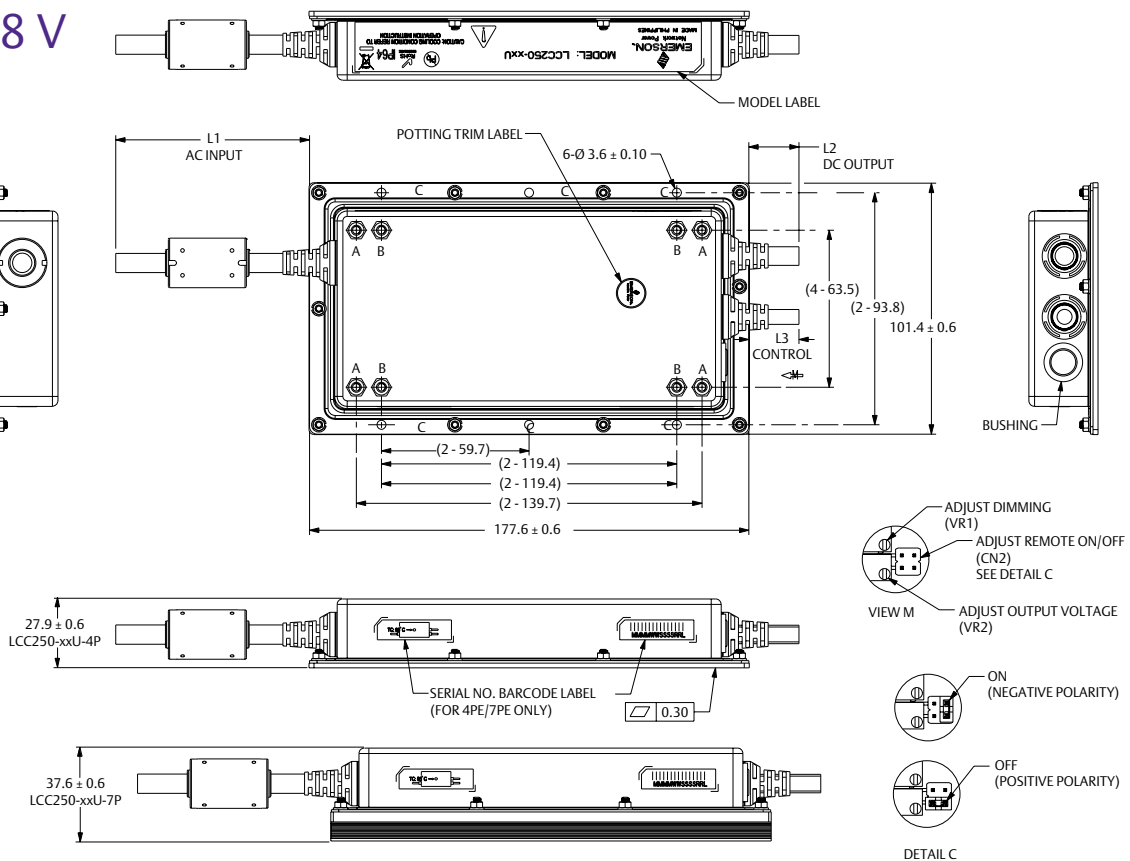

Cable	Length	Designation	Wire Color	Wire Gauge
AC Input Cable	L1 = 300 ± 10 mm	L = Live	Brown	AWG#18
		N = Neutral	Blue	AWG#18
		PE = Primary Earth	Green/Yellow	AWG#18
DC Output Cable	L2 = 300 ± 10 mm	+Output	Blue	AWG#14
		-Output	Gray	AWG#14
Control Cable	L3 = 300 ± 10 mm	Dimming	Brown	AWG#26
		Dimming Return	Yellow	AWG#26
		ON/OFF	Orange	AWG#26
		ON/OFF Return	White	AWG#26
		Sense	Red	AWG#26
		Sense Return	Black	AWG#26

Americas

5810 Van Allen Way
Carlsbad, CA 92008
USA
Telephone: +1 760 930 4600
Facsimile: +1 760 930 0698

Europe (UK)

Waterfront Business Park
Merry Hill, Dudley
West Midlands, DY5 1LX
United Kingdom
Telephone: +44 (0) 1384 842 211
Facsimile: +44 (0) 1384 843 355

Asia (HK)

14/F, Lu Plaza
2 Wing Yip Street
Kwun Tong, Kowloon
Hong Kong
Telephone: +852 2176 3333
Facsimile: +852 2176 3888

For global contact, visit:

www.Emerson.com/EmbeddedPower
techsupport.embeddedpower@emerson.com

While every precaution has been taken to ensure accuracy and completeness in this literature, Emerson Network Power assumes no responsibility, and disclaims all liability for damages resulting from use of this information or for any errors or omissions.

Emerson Network Power.

The global leader in enabling business-critical continuity.

- AC Power
- Connectivity
- DC Power
- Embedded Computing
- **Embedded Power**
- Monitoring
- Outside Plant
- Power Switching & Controls
- Precision Cooling
- Racks & Integrated Cabinets
- Services
- Surge Protection

EmersonNetworkPower.com

Emerson Network Power and the Emerson Network Power logo are trademarks and service marks of Emerson Electric Co.
©2011 Emerson Electric Co.



Компания «ЭлектроПласт» предлагает заключение долгосрочных отношений при поставках импортных электронных компонентов на взаимовыгодных условиях!

Наши преимущества:

- Оперативные поставки широкого спектра электронных компонентов отечественного и импортного производства напрямую от производителей и с крупнейших мировых складов;
- Поставка более 17-ти миллионов наименований электронных компонентов;
- Поставка сложных, дефицитных, либо снятых с производства позиций;
- Оперативные сроки поставки под заказ (от 5 рабочих дней);
- Экспресс доставка в любую точку России;
- Техническая поддержка проекта, помощь в подборе аналогов, поставка прототипов;
- Система менеджмента качества сертифицирована по Международному стандарту ISO 9001;
- Лицензия ФСБ на осуществление работ с использованием сведений, составляющих государственную тайну;
- Поставка специализированных компонентов (Xilinx, Altera, Analog Devices, Intersil, Interpoint, Microsemi, Aeroflex, Peregrine, Syfer, Eurofarad, Texas Instrument, Miteq, Cobham, E2V, MA-COM, Hittite, Mini-Circuits, General Dynamics и др.);

Помимо этого, одним из направлений компании «ЭлектроПласт» является направление «Источники питания». Мы предлагаем Вам помощь Конструкторского отдела:

- Подбор оптимального решения, техническое обоснование при выборе компонента;
- Подбор аналогов;
- Консультации по применению компонента;
- Поставка образцов и прототипов;
- Техническая поддержка проекта;
- Защита от снятия компонента с производства.



Как с нами связаться

Телефон: 8 (812) 309 58 32 (многоканальный)

Факс: 8 (812) 320-02-42

Электронная почта: org@eplast1.ru

Адрес: 198099, г. Санкт-Петербург, ул. Калинина, дом 2, корпус 4, литера А.