

# MAX11214

## 24-Bit, 5mW, 140dB SNR, 32ksps Delta-Sigma ADC with Integrated PGA

### General Description

The MAX11214 is a 24-bit delta-sigma ADC that achieves excellent 140dB SNR while dissipating an ultra-low 5mW. Sample rates up to 32ksps allow both precision DC and AC measurements. Integral nonlinearity is guaranteed to 4ppm maximum. The THD is -122dB. The MAX11214 communicates via an SPI-compatible serial interface and is available in a small 24-pin TSSOP package.

The MAX11214 offers a  $6.5\text{nV}/\sqrt{\text{Hz}}$  noise programmable gain amplifier with gain settings between 1x to 128x. Optional buffers are also included to provide isolation of the signal inputs from the switched capacitor sampling network. This allows the MAX11214 to be used with high-impedance sources without compromising available dynamic range.

The MAX11214 operates from a single 2.7V to 3.6V analog supply, or split  $\pm 1.8\text{V}$  analog supplies, allowing the analog input to be sampled below ground. The digital supply range is 2.0V to 3.6V, allowing communication with 2.5V, 3V, or 3.3V logic.

### Applications

- Seismic Data Acquisition
- Scientific Instrumentation
- High-Precision Portable Sensors
- Medical Equipment
- ATE

*[Ordering Information](#) and [Functional Diagram](#) appear at end of data sheet.*

### Benefits and Features

- High Resolution for Instrumentation Applications that Require a Wide Dynamic Range
  - 134dB SNR at 15.6sps
  - 124dB SNR at 500sps
  - 21-Bit Noise-Free Resolution at 50sps
  - 18.6-Bit Noise-Free Resolution at 1ksps
- Longer Battery Life for Portable Applications
  - 1.2mA Operating Mode Current from AVDD
  - 2.6mA PGA Low-Noise Mode Current from AVDD
  - 1 $\mu\text{A}$  Sleep Current
- High Accuracy for DC Measurements
  - 1ppm INL (typ), 4ppm (max)
- Single or Split Analog Supplies Provide Input Voltage Range Flexibility
  - 2.7V to 3.6V (Single Supply) or  $\pm 1.8\text{V}$  (Split Supplies)
- Flexible High-Performance Filter Architecture Simplifies Design
  - Programmable SINC + FIR + IIR
  - Linear or Minimum Phase Response
  - Programmable Highpass Filter
  - Selectable FIR Data Rates: 62.5sps to 8ksps
- Enables System Integration
  - Low-Noise PGA with Gains of 1, 2, 4, 8, 16, 32, 64, 128
  - Signal Buffer Optional
  - 3 General-Purpose I/Os
- Enables Integrated Part and System Calibration Capability for Gain and Offset
- Robust 24-Pin TSSOP Packaging

---

**TABLE OF CONTENTS**

---

General Description . . . . .	1
Applications . . . . .	1
Benefits and Features . . . . .	1
Absolute Maximum Ratings . . . . .	6
Package Thermal Characteristics . . . . .	6
Electrical Characteristics . . . . .	6
Typical Operating Characteristics . . . . .	11
Pin Configuration . . . . .	15
Pin Description . . . . .	15
Functional Diagram . . . . .	17
Detailed Description . . . . .	18
System Clock . . . . .	18
Voltage Reference Inputs . . . . .	18
Analog Inputs . . . . .	18
Input Buffers . . . . .	18
Bypass/Direct Connect . . . . .	18
Programmable Gain Amplifier (PGA) . . . . .	18
Input Voltage Range . . . . .	19
Noise Performance vs. Data Rate . . . . .	19
Power-On Reset . . . . .	25
Power-Down Modes . . . . .	25
Digital Filters . . . . .	27
SINC Filter . . . . .	27
FIR Filter . . . . .	27
Highpass Filter . . . . .	30
Serial Interface . . . . .	31
Chip Select (CSB) . . . . .	31
SCLK (Serial Clock) . . . . .	31
DIN (Serial Data Input) . . . . .	31
DOUT (Serial Data Output) . . . . .	31
Data Ready (RDYB) . . . . .	31
SPI Incomplete Write Command Termination . . . . .	32
SPI Incomplete Read Command Termination . . . . .	32
SPI Timing Characteristics . . . . .	32
Modes and Registers . . . . .	35
Conversion Mode (MODE = 0) . . . . .	35
Register Access Mode (MODE = 1) . . . . .	35

**TABLE OF CONTENTS (continued)**

Register Map . . . . .	36
Register Address Map . . . . .	36
Status Register (Read Only) . . . . .	37
Control Registers . . . . .	39
Control 1 Register (Read/Write) . . . . .	39
Control 2 Register (Read/Write) . . . . .	40
Control 3 Register (Read/Write) . . . . .	41
Control 4 Register (Read/Write) . . . . .	41
Control 5 Register (Read/Write) . . . . .	42
Data Register (Read Only) . . . . .	42
Calibration . . . . .	43
Self-Calibration . . . . .	43
System Calibration . . . . .	43
SPI System Offset Calibration Register (SOC_SPI) . . . . .	44
ADC System Offset Calibration Register (SOC_ADC) . . . . .	44
SPI System Gain Calibration Register (SGC_SPI) . . . . .	44
ADC System Gain Calibration Register (SGC_ADC) . . . . .	44
SPI Self-Cal Offset Calibration Register (SCOC_SPI) . . . . .	45
ADC Self-Cal Offset Calibration Register (SCOC_ADC) . . . . .	45
SPI Self-Cal Gain Calibration Register (SCGC_SPI) . . . . .	45
ADC Self-Cal Gain Calibration Register (SCGC_ADC) . . . . .	45
Highpass Filter Configuration Register (Read/Write) . . . . .	47
GPIOs . . . . .	47
Conversion Synchronization Using SYNC Pin or SYNC_SPI Function . . . . .	47
Continuous Mode . . . . .	47
Modulator MODBITS Mode . . . . .	48
Initializing MODBITS Mode . . . . .	48
Exiting MODBITS Mode . . . . .	48
MODBITS Mode Pin Configurations . . . . .	48
DOUT/MB0 . . . . .	49
GPIO3/MSYNC . . . . .	49
GPIO1/MB1 . . . . .	49
RDYB/ICLK . . . . .	49
Typical Application Circuit . . . . .	51
Ordering Information . . . . .	52
Chip Information . . . . .	52
Package Information . . . . .	52
Revision History . . . . .	53

---

**LIST OF FIGURES**

---

Figure 1. PGA Structure . . . . .	19
Figure 2. Usable Input and Output Common-Mode Range . . . . .	19
Figure 3. Digital Filter Path . . . . .	27
Figure 4a. SINC Magnitude Response . . . . .	27
Figure 4b. SINC Mag Response Zoomed-In . . . . .	27
Figure 5. Magnitude Response, Linear Phase FIR, 8ksps Data Rate . . . . .	28
Figure 6. Magnitude Response, Minimum Phase FIR, 8ksps Data Rate . . . . .	28
Figure 7. Passband Ripple, Linear Phase FIR, 8ksps Data Rate . . . . .	28
Figure 8. Passband Ripple, Minimum Phase FIR, 8ksps Data Rate . . . . .	28
Figure 9. Phase Response, Linear Phase FIR, 8ksps Data Rate . . . . .	29
Figure 10. Step Response, Linear Phase FIR . . . . .	29
Figure 11. Phase Response, Minimum Phase FIR, 8ksps Data Rate . . . . .	29
Figure 12. Step Response, Minimum Phase FIR . . . . .	29
Figure 13. DATA Ready Timing for All Conversion Modes . . . . .	31
Figure 14. SPI Register Write Timing Diagram . . . . .	32
Figure 15. SPI Register Read Timing Diagram . . . . .	33
Figure 16. SPI Data Readout Timing Diagram . . . . .	33
Figure 17. SPI Command Byte Timing Diagram . . . . .	34
Figure 18. Calibration Flow Diagram . . . . .	46
Figure 19. Synchronization Using Continuous Sync Mode Showing Relationship Between SYNC Pin and CLK Pin	47
Figure 20. Synchronization Using Pulse Sync Mode Showing Relationship Between SYNC, RDYB, and CLK Pins	48
Figure 21. Pin Configuration with MODBITS . . . . .	48
Figure 22. Timing Diagram for MODBITS Mode . . . . .	50

---

**LIST OF TABLES**

---

Table 1. Continuous Mode SNR vs Data Rate and PGA Gain with FIR Filter*	20
Table 2. Continuous Mode Input Referred Noise ( $\mu\text{V}_{\text{RMS}}$ ) vs Data Rate and PGA Gain with FIR Filter*	20
Table 3. Continuous Mode SNR (dB) vs Data Rate and PGA Gain with Sinc Filter*	21
Table 4. Continuous Mode Input-Referred Noise ( $\mu\text{V}_{\text{RMS}}$ ) vs. Data Rate and PGA Gain with Sinc Filter*	22
Table 5. Single-Cycle Mode SNR (dB) vs. Data Rate and PGA Gain with Sinc Filter*	23
Table 6. Single-Cycle Mode Input-Referred Noise ( $\mu\text{V}_{\text{RMS}}$ ) vs. Data Rate and PGA Gain with Sinc Filter*	24
Table 7. MAX11214 Command Behavior from Pin (RSTB, SYNC) and SPI (RESET, SYNC_SPI)	25
Table 8. Max HPF[15:0] Register Values for Different Data Rates	30
Table 9. Examples of HPF[15:0] Register Values and Cutoff Frequencies	30
Table 10. Command Byte for Conversion Modes (MODE = 0)	35
Table 11. Command Byte for Register Access Mode (MODE = 1)	35
Table 12. Register Address Map	36
Table 13. Programmable Conversion Rates	38
Table 14. ADC Output Code Data Format	43
Table 15. MODBITS Mode Pins	49

**Absolute Maximum Ratings**

AVDD to AVSS .....	-0.3V to +3.9V	Digital Inputs to AVSS (RSTB, SYNC, DIN, SCLK, CLK, GPIO1–GPIO3).....	-0.3V to +3.9V
DVDD to DGND.....	-0.3V to +3.9V	Digital Outputs to AVSS (RDYB, DOUT, GPIO1-3).....	-0.3V to +3.9V
DVDD to AVSS .....	-0.3V to +3.9V	CAPREG to DGND.....	-0.3V to +2.2V
AVSS to DGND .....	-1.95V to +0.3V	CAPREG to AVSS.....	-0.3V to +3.9V
Analog Inputs (AINP, AINM, REFP, REFN, CAPP, CAPN) to AVSS .....	-0.3V to the lower of 3.9V or (V <sub>AVDD</sub> + 0.3V)	Continuous Power Dissipation (Single-Layer Board) TSSOP (derate 13.9mW/°C above +70°C).....	1111.10mW
Digital Inputs to DGND (RSTB, SYNC, DIN, SCLK, CLK, GPIO1-3) .....	-0.3V to the lower of 3.9V or (V <sub>DVDD</sub> + 0.3V)	Operating Temperature Range.....	-40°C to +85°C
Digital Outputs to DGND (RDYB, DOUT, GPIO1-3) .....	-0.3V to the lower of 3.9V or (V <sub>DVDD</sub> + 0.3V)	Storage Temperature Range.....	-55°C to +150°C
		Junction Temperature (continuous).....	+150°C
		Lead temperature (soldering, 10s).....	+300°C
		Soldering Temperature (reflow).....	+260°C

Stresses beyond those listed under "Absolute Maximum Ratings" may cause permanent damage to the device. These are stress ratings only, and functional operation of the device at these or any other conditions beyond those indicated in the operational sections of the specifications is not implied. Exposure to absolute maximum rating conditions for extended periods may affect device reliability.

**Package Thermal Characteristics (Note 1)**

TSSOP Junction-to-Case Thermal Resistance(θ <sub>JC</sub> ).....	13°C/W	Junction-to-Ambient Thermal Resistance (θ <sub>JA</sub> ).....	72°C/W
---	--------	--	--------

**Note 1:** Package thermal resistances were obtained using the method described in JEDEC specification JESD51-7, using a four-layer board. For detailed information on package thermal considerations, refer to [www.maximintegrated.com/thermal-tutorial](http://www.maximintegrated.com/thermal-tutorial).

**Electrical Characteristics**

(V<sub>AVDD</sub> = 3.6V, V<sub>AVSS</sub> = 0V, V<sub>DVDD</sub> = 2.0V, V<sub>REFP</sub> = 2.5V, V<sub>REFN</sub> = 0V; f<sub>DATA</sub> = 1000sps, External Clock = f<sub>CLK</sub> = 4.096MHz; Continuous conversion mode (SCYCLE = 0); PGA maximum output is 300mV below AVDD and minimum output is 300mV above AVSS, T<sub>A</sub> = T<sub>MIN</sub> to T<sub>MAX</sub>, unless otherwise noted. Typical values are at T<sub>A</sub> = +25°C.) (Note 2)

PARAMETER	SYMBOL	CONDITIONS	MIN	TYP	MAX	UNITS
<b>STATIC PERFORMANCE</b>						
Noise-Free Resolution (Note 3)	NFR	50sps data rate, Bypass mode only	20.2	21		Bits
		1ksps data rate, Bypass mode only	18.0	18.6		
<b>NOISE REFERRED TO INPUT V<sub>N</sub> (See Tables 1–4)</b>						
Integral Nonlinearity	INL	Bypass, Buffer, PGA = 1, 2		1	4	ppm
		PGA > 2		2		
Offset Error	V <sub>OS</sub>	After system offset calibration		10		nV
Offset Drift	V <sub>OS_DRIFT</sub>			50		nV/°C
Gain Error	G <sub>ERR</sub>	After system gain calibration		2		ppm
Gain Drift	G <sub>ERR_DRIFT</sub>			0.05		ppm/°C
DC Common-Mode Rejection	CMR <sub>DC</sub>	Bypass and Buffer mode	125	135		dB
		PGA Gain = 4	110	120		
AVDD, AVSS DC Supply Rejection Ratio	PSRRA	Bypass and Buffer mode	85	105		dB
		PGA Gain = 4	85	100		
DVDD DC Supply Rejection Ratio	PSRRD	Bypass and Buffer mode	110	120		dB
		PGA Gain = 4	105	120		

**Electrical Characteristics (continued)**

( $V_{AVDD} = 3.6V$ ,  $V_{AVSS} = 0V$ ,  $V_{DVDD} = 2.0V$ ,  $V_{REFP} = 2.5V$ ,  $V_{REFN} = 0V$ ;  $f_{DATA} = 1000sps$ , External Clock =  $f_{CLK} = 4.096MHz$ ; Continuous conversion mode (SCYCLE = 0); PGA maximum output is 300mV below AVDD and minimum output is 300mV above AVSS,  $T_A = T_{MIN}$  to  $T_{MAX}$ , unless otherwise noted. Typical values are at  $T_A = +25^{\circ}C$ .) (Note 2)

PARAMETER	SYMBOL	CONDITIONS	MIN	TYP	MAX	UNITS
<b>DYNAMIC PERFORMANCE</b>						
Signal-to-Noise Ratio (Notes 5 and 7)	SNR	Bypass, Buffer (see Tables 1 to 6)	117	121		dB
		PGA Gain = 2 (see Tables 1 to 6)	116.4	120		
Total Harmonic Distortion ( $f_{SIGNAL} = 31.25Hz$ )	THD	Bypass, Buffer		-120	-116	dB
		PGA = 1, 2		-122	-113	
		PGA = 4, 8, 16, 32		-120		
		PGA = 64		-118		
Spurious-Free Dynamic Range ( $f_{SIGNAL} = 31.25Hz$ )	SFDR	Bypass, Buffer		122		dB
		PGA = 4		122		
<b>ANALOG INPUTS/REFERENCE INPUTS</b>						
AIN Voltage Range	$V_{RNG}$	Unipolar	0		$V_{REF}$	V
		Bipolar	$-V_{REF}$		$V_{REF}$	
Absolute Input Voltage	$V_{ABS_{RNG}}$	Bypass mode	$V_{AVSS}$		$V_{AVDD}$	V
		PGA mode	$V_{AVSS} + 0.3$		$V_{AVDD} - 1.3$	
		Buffer mode	$V_{AVSS} + 0.1$		$V_{AVDD} - 0.1$	
AIN DC Input Leakage	$I_{IN_{LEAK}}$	Sleep mode enabled	-10		+10	nA
AIN Common-Mode Input Conductance	$G_{AINCM}$	Bypass		$\pm 4$		nA/V
AIN Common-Mode Input Current	$I_{AINCM}$	Buffer		$\pm 250$		nA
		PGA		$\pm 10$		nA
AIN Differential Mode Input Conductance	$G_{AINDIFF}$	Bypass		$\pm 11.5$		$\mu A/V$
AIN Differential Mode Input Current	$I_{AINDIFF}$	Buffer		$\pm 10$		nA
		PGA		$\pm 0.15$		nA
REF Differential Input Conductance	$G_{REFDIFF}$	Active conversion state		$\pm 23.8$		$\mu A/V$
REF Input Current at Power Down	$I_{REF\_PD}$	Sleep and Standby states		$\pm 100$		nA
AIN Input Capacitance	$C_{IN}$	Buffer disabled		3		pF
REF Input Capacitance	$C_{REF}$	Buffer disabled		4.5		pF
Input and REF Sampling Rate	$f_S$			2.048		MHz
$V_{REFP} - V_{REFN}$ Voltage Range	$V_{RABS_{RNG}}$	(Note 6)			$V_{AVDD}$	V

**Electrical Characteristics (continued)**

( $V_{AVDD} = 3.6V$ ,  $V_{AVSS} = 0V$ ,  $V_{DVDD} = 2.0V$ ,  $V_{REFP} = 2.5V$ ,  $V_{REFN} = 0V$ ;  $f_{DATA} = 1000\text{sps}$ , External Clock =  $f_{CLK} = 4.096\text{MHz}$ ; Continuous conversion mode (SCYCLE = 0); PGA maximum output is 300mV below AVDD and minimum output is 300mV above AVSS,  $T_A = T_{MIN}$  to  $T_{MAX}$ , unless otherwise noted. Typical values are at  $T_A = +25^\circ\text{C}$ .) (Note 2)

PARAMETER	SYMBOL	CONDITIONS	MIN	TYP	MAX	UNITS
REF Voltage Range	$V_{REF}$		2.0		$V_{AVDD}$	V
<b>DIGITAL FILTER RESPONSE</b>						
<b>SINC FILTER</b>						
Bandwidth (-3dB)	$BW_{SINC}$			0.203		$f_{DATA}$
Settling Time (Latency)				5		$1/f_{DATA}$
<b>FIR FILTER</b>						
Passband Ripple			-0.003		+0.003	dB
Passband (-0.01dB)			0.375			$f_{DATA}$
Bandwidth (-3dB)	$BW_{FIR}$		0.413			$f_{DATA}$
Highpass Filter Corner	$f_{HP}$		0.000375		0.1	$f_{DATA}$
Stopband Attenuation			135			dB
Stopband	$f_{STOP}$			0.5		$f_{DATA}$
Group Delay		Minimum phase filter		5		$1/f_{DATA}$
		Linear phase filter		31		
Settling Time (Latency)		Minimum phase filter		10		$1/f_{DATA}$
		Linear phase filter		62		
<b>LOGIC INPUTS</b>						
Input Current	$I_{LEAK\_DIG}$	Leakage current only	-1		+1	$\mu\text{A}$
Input Low Voltage	$V_{IL}$				$0.3 \times V_{DVDD}$	V
Input High Voltage	$V_{IH}$		$0.7 \times V_{DVDD}$			V
Input Hysteresis	$V_{HYS}$			200		mV
GPIO Input Low Voltage	$V_{IL\_GPIO}$				0.4	V
GPIO Input High Voltage	$V_{IH\_GPIO}$		1.0			V
GPIO Input Hysteresis	$V_{HYS\_GPIO}$			20		mV
<b>LOGIC OUTPUTS</b>						
Output Low Level	$V_{OL}$	$I_{OL} = 1\text{mA}$			0.4	V
Output High Level	$V_{OH}$	$I_{OH} = 1\text{mA}$	$0.9 \times V_{DVDD}$			V
Floating State Leakage Current	$I_{DIGO\_LEAK}$		-10		+10	$\mu\text{A}$
Floating State Output Capacitance	$C_{DIGO}$			9		pF



**Electrical Characteristics (continued)**

( $V_{AVDD} = 3.6V$ ,  $V_{AVSS} = 0V$ ,  $V_{DVDD} = 2.0V$ ,  $V_{REFP} = 2.5V$ ,  $V_{REFN} = 0V$ ;  $f_{DATA} = 1000\text{sps}$ , External Clock =  $f_{CLK} = 4.096\text{MHz}$ ; Continuous conversion mode (SCYCLE = 0); PGA maximum output is 300mV below AVDD and minimum output is 300mV above AVSS,  $T_A = T_{MIN}$  to  $T_{MAX}$ , unless otherwise noted. Typical values are at  $T_A = +25^\circ\text{C}$ .) (Note 2)

PARAMETER	SYMBOL	CONDITIONS	MIN	TYP	MAX	UNITS
<b>POWER REQUIREMENTS</b>						
Analog Negative Supply	$V_{AVSS}$	For split supplies, $V_{AVSS} = -V_{AVDD}$	-1.8		0	V
Analog Positive Supply	$V_{AVDD}$	For split supplies, $V_{AVDD} = -V_{AVSS}$	$V_{AVSS} + 2.7$		$V_{AVSS} + 3.6$	V
Digital Supply	$V_{DVDD}$		2.0		3.6	V
AVDD Sleep Current	$I_{AVDD\_SLEEP}$			0.9	3	$\mu\text{A}$
AVDD Standby Current	$I_{AVDD\_STBY}$			1.5	3	$\mu\text{A}$
DVDD Sleep Current	$I_{DVDD\_SLEEP}$			0.25	1	$\mu\text{A}$
DVDD Standby Current	$I_{DVDD\_STBY}$			21	200	$\mu\text{A}$
Analog Supply Current	$I_{AVDD}$	Bypass mode		1.2	1.6	mA
		Buffers mode		1.4	1.7	
		PGA low-power mode		2.0	2.75	
		PGA low-noise mode		2.6	3.4	
DVDD Operating Current		SINC filter		0.4	0.5	mA
		FIR filter, 1000sps		0.55	0.7	
		FIR filter, 8ksps		1.75	2.25	
<b>SPI TIMING REQUIREMENTS (See Figure 14–17)</b>						
SCLK Frequency	$f_{SCLK}$				5	MHz
SCLK Clock Period	$t_{CP}$		200			ns
SCLK Pulse Width High	$t_{CH}$	Allow 40% duty cycle	80			ns
SCLK Pulse Width Low	$t_{CL}$	Allow 40% duty cycle	80			ns
CSB Low Setup	$t_{CSS0}$	CSB low to 1st SCLK rise setup	40			ns
CSB High Setup (Note 4)	$t_{CSS1}$	Required to prevent a 17th SCLK RE from being recognized by the device in a free-running application	40			ns
CSB Hold	$t_{CSH1}$	SCLK falling edge to CSB rising edge, CSB hold time	3			ns
CSB Pulse Width	$t_{CSW}$	Minimum CSB pulse width high	40			ns
DIN Setup	$t_{DS}$	DIN setup to SCLK rising edge	40			ns
DIN Hold	$t_{DH}$	DIN hold after SCLK rising edge	0			ns
DOUT Transition	$t_{DOT}$	DOUT transition valid after SCLK fall			40	ns

**Electrical Characteristics (continued)**

( $V_{AVDD} = 3.6V$ ,  $V_{AVSS} = 0V$ ,  $V_{DVDD} = 2.0V$ ,  $V_{REFP} = 2.5V$ ,  $V_{REFN} = 0V$ ;  $f_{DATA} = 1000\text{sps}$ , External Clock =  $f_{CLK} = 4.096\text{MHz}$ ; Continuous conversion mode (SCYCLE = 0); PGA maximum output is 300mV below AVDD and minimum output is 300mV above AVSS,  $T_A = T_{MIN}$  to  $T_{MAX}$ , unless otherwise noted. Typical values are at  $T_A = +25^\circ\text{C}$ .) (Note 2)

PARAMETER	SYMBOL	CONDITIONS	MIN	TYP	MAX	UNITS
DOUT Hold	$t_{DOH}$	Output hold time remains valid after SCLK fall	3			ns
DOUT Disable	$t_{DOD}$	CSB rise to DOUT disable, $C_{LOAD} = 20\text{pF}$			25	ns
CSB Fall to DOUT Valid	$t_{DOE}$	Default value of DOUT is '1' for minimum specification, max specification for valid '0' on RDYB	0		40	ns
SCLK Fall to RDYB '1'	$t_{R1}$	RDYB transitions from '0' to '1' on falling edge of SCLK after LSB of DATA is shifted onto DOUT	0		40	ns
RSTB Fall or SYNC Rise to RDYB '1'	$t_{R2}$	RDYB transitions from '0' to '1' on falling edge of RSTB or rising edge of SYNC after 2 $f_{CLK}$ cycles			2	$1/f_{CLK}$
Minimum SYNC High Pulse Width	$t_{SYNC1}$		2			$1/f_{CLK}$
Minimum RSTB Low Pulse Width	$t_{RSTB0}$		2			$1/f_{CLK}$

**Note 2:** Limits are 100% production tested at  $T_A = +25^\circ\text{C}$ . Limits over the operating temperature range are guaranteed by design and device characterization.

**Note 3:** Noise-free resolution is defined using the peak-to-peak input range and the peak-to-peak noise voltage. The peak-to-peak input range,  $V_{IN\_RANGE\_PP}$  is defined as  $2 \times V_{REF}$ . The peak-to-peak noise voltage is defined as the RMS noise voltage times 6.6. The NFR is calculated for bypass mode only and with SINC filter using the formula,  $NFR = \log(V_{IN\_RANGE\_PP} / (6.6 \times V_{NOISE\_RMS})) / \log(2)$ .

**Note 4:** These specifications are not fully tested and are guaranteed by design and/or characterization.

**Note 5:** Tested with input shorted ( $V_{AINP} - V_{AINN} = 0V$ ).  $SNR = 20 \times \log_{10}((V_{IN\_RANGE}) / (\sqrt{2} \times V_{NOISE\_RMS}))$ . SNR is calculated for a 3.6V reference.

**Note 6:** Reference common mode  $(V_{REFP} + V_{REFN})/2 \leq (V_{AVDD} + V_{AVSS})/2 + 0.1V$ .

**Note 7:** Typical values tested with 150mV supply headroom.

Typical Operating Characteristics

( $V_{AVDD} = 3.6V$ ,  $V_{AVSS} = 0V$ ,  $V_{DVDD} = 2.0V$ ,  $V_{REFP} = 2.5V$ ,  $V_{REFN} = 0V$ ;  $f_{DATA} = 1000sps$ , External Clock =  $f_{CLK} = 4.096MHz$ ; Continuous conversion mode (SCYCLE = 0); PGA maximum output is 300mV below AVDD and minimum output is 300mV above AVSS,  $T_A = T_{MIN}$  to  $T_{MAX}$ , unless otherwise noted. Typical values are at  $T_A = +25^{\circ}C$ .)

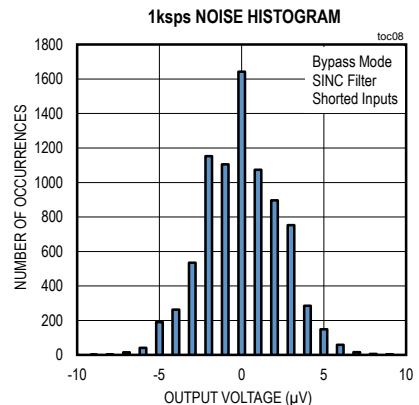
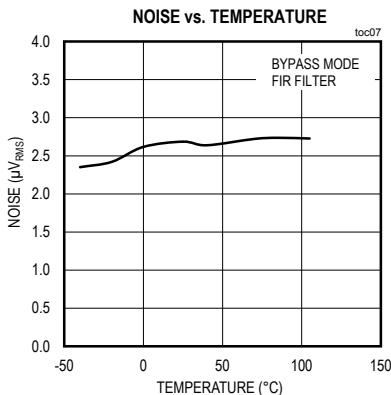
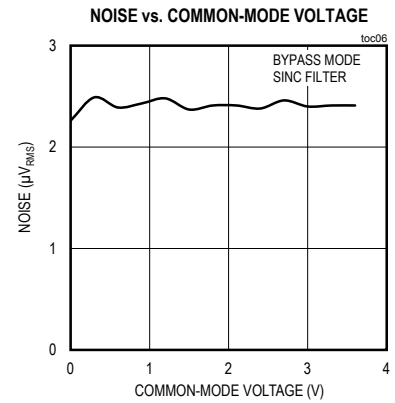
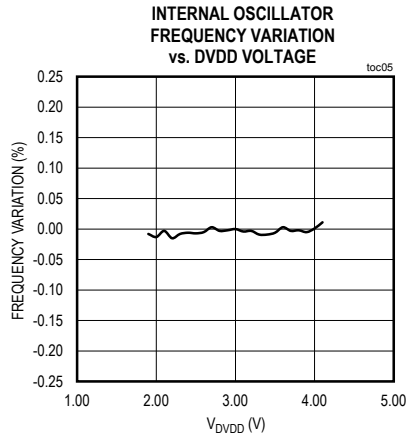
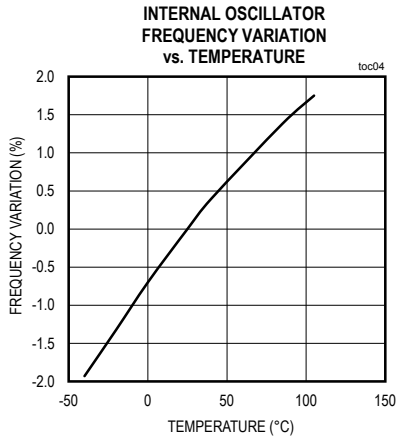
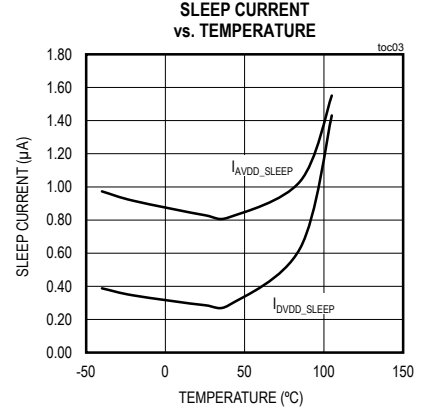
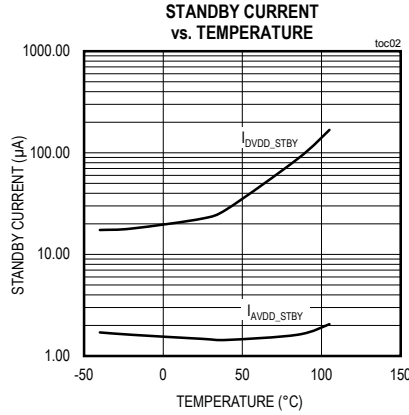
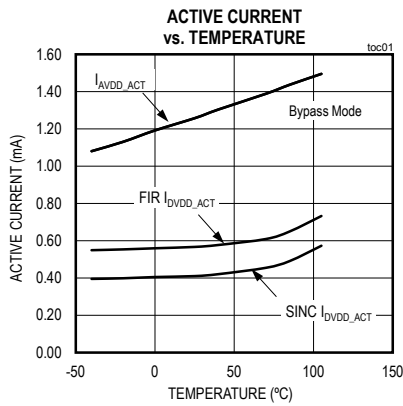

Typical Operating Characteristics (continued)

( $V_{AVDD} = 3.6V$ ,  $V_{AVSS} = 0V$ ,  $V_{DVDD} = 2.0V$ ,  $V_{REFP} = 2.5V$ ,  $V_{REFN} = 0V$ ;  $f_{DATA} = 1000sps$ , External Clock =  $f_{CLK} = 4.096MHz$ ; Continuous conversion mode (SCYCLE = 0); PGA maximum output is 300mV below AVDD and minimum output is 300mV above AVSS,  $T_A = T_{MIN}$  to  $T_{MAX}$ , unless otherwise noted. Typical values are at  $T_A = +25^{\circ}C$ .)

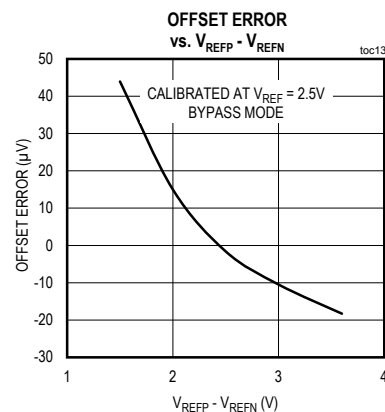
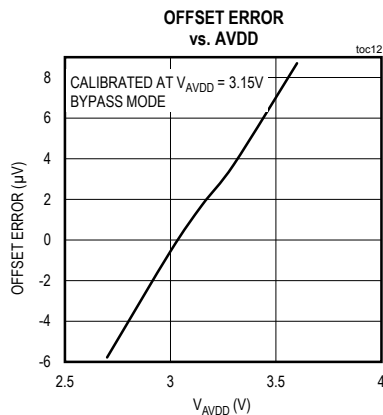
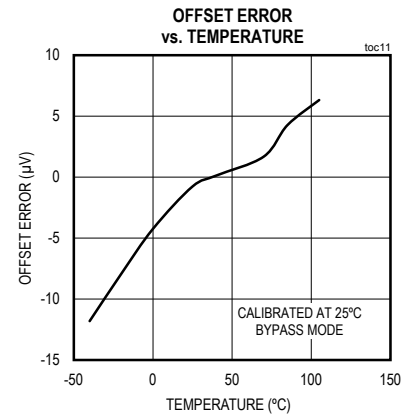
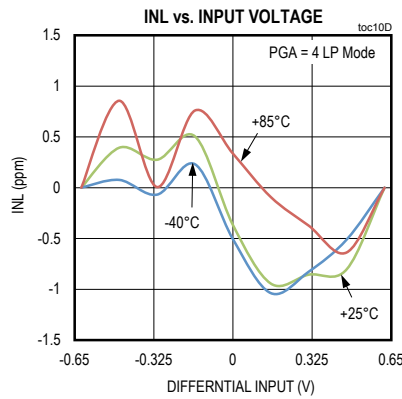
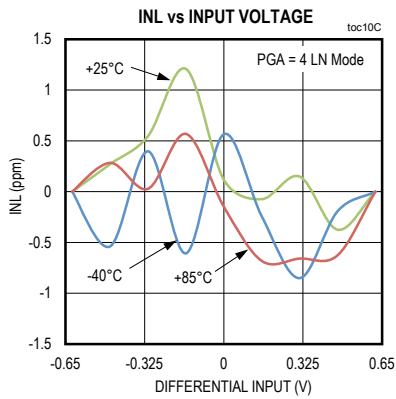
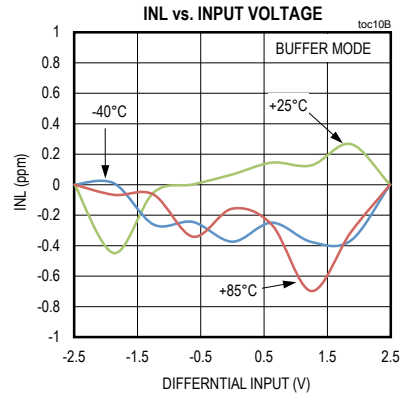
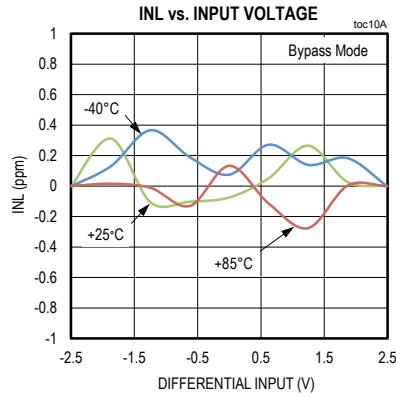
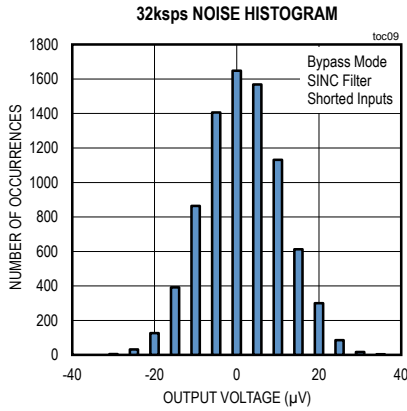

Typical Operating Characteristics (continued)

( $V_{AVDD} = 3.6V$ ,  $V_{AVSS} = 0V$ ,  $V_{DVDD} = 2.0V$ ,  $V_{REFP} = 2.5V$ ,  $V_{REFN} = 0V$ ;  $f_{DATA} = 1000sps$ , External Clock =  $f_{CLK} = 4.096MHz$ ; Continuous conversion mode (SCYCLE = 0); PGA maximum output is 300mV below AVDD and minimum output is 300mV above AVSS,  $T_A = T_{MIN}$  to  $T_{MAX}$ , unless otherwise noted. Typical values are at  $T_A = +25^{\circ}C$ .)

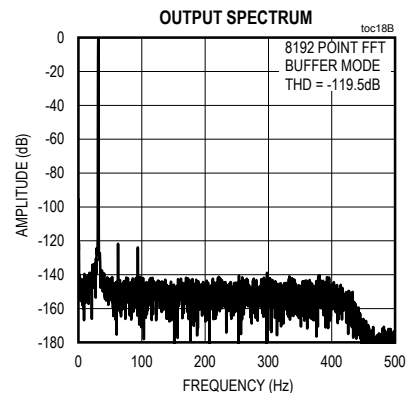
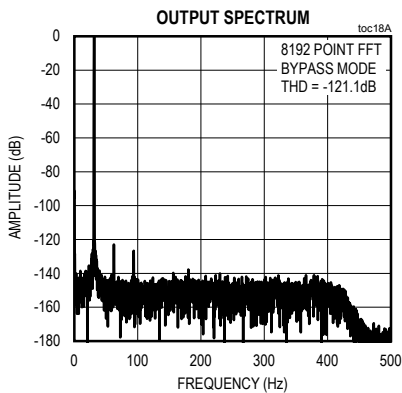
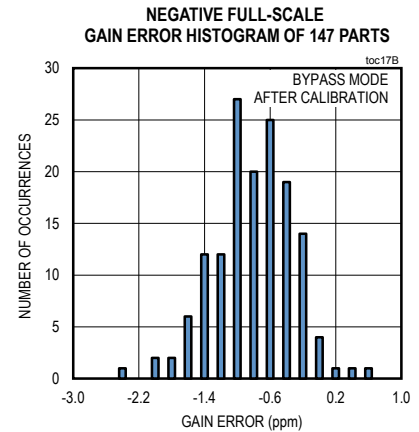
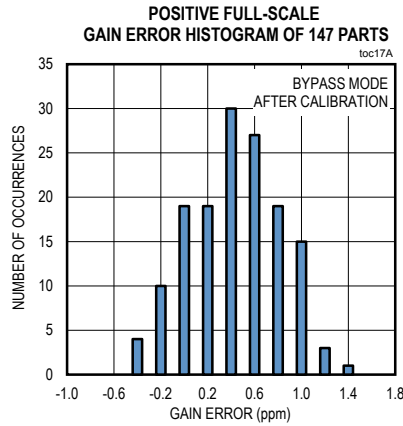
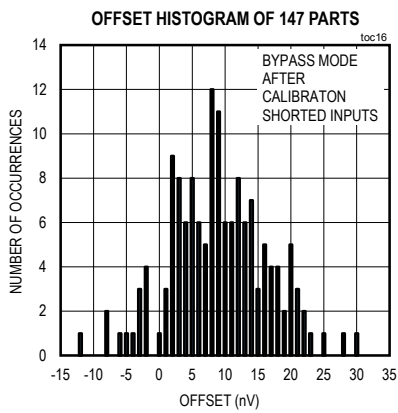
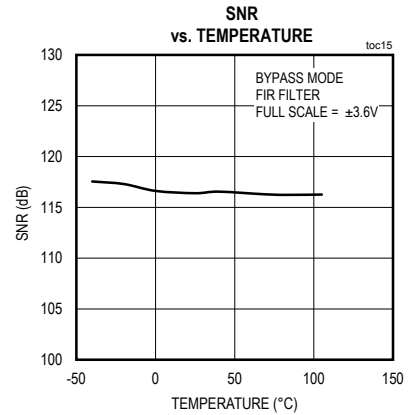
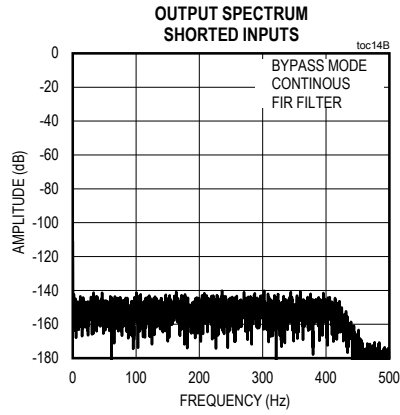
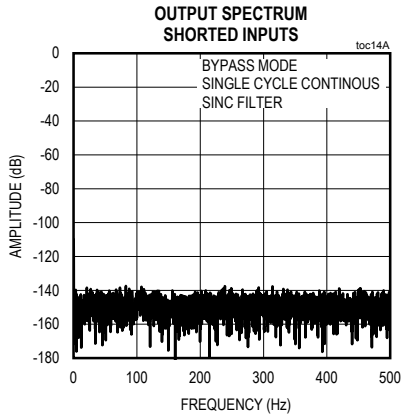

Typical Operating Characteristics (continued)

( $V_{AVDD} = 3.6V$ ,  $V_{AVSS} = 0V$ ,  $V_{DVDD} = 2.0V$ ,  $V_{REFP} = 2.5V$ ,  $V_{REFN} = 0V$ ;  $f_{DATA} = 1000sps$ , External Clock =  $f_{CLK} = 4.096MHz$ ; Continuous conversion mode (SCYCLE = 0); PGA maximum output is 300mV below AVDD and minimum output is 300mV above AVSS,  $T_A = T_{MIN}$  to  $T_{MAX}$ , unless otherwise noted. Typical values are at  $T_A = +25^{\circ}C$ .)

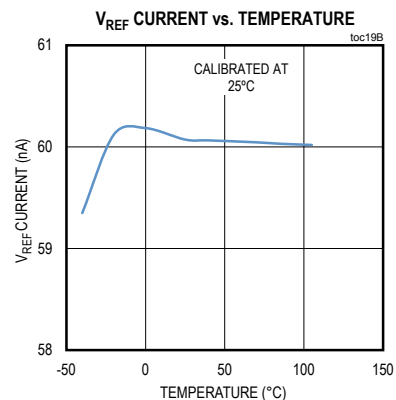
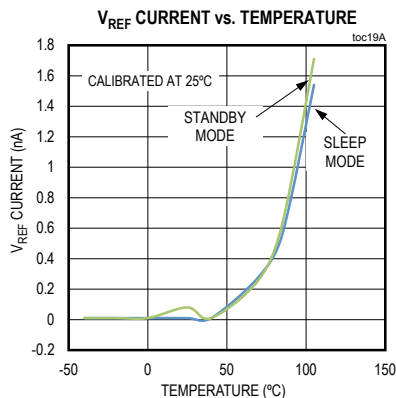
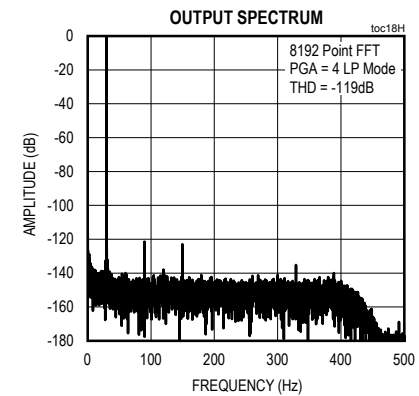
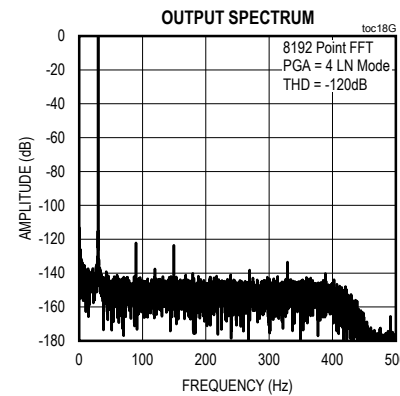
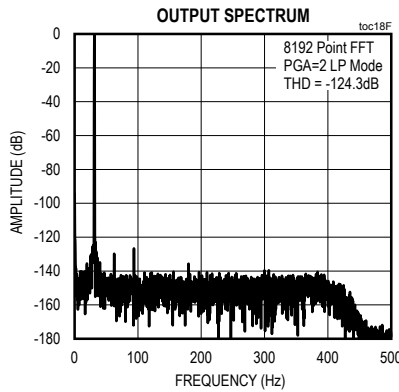
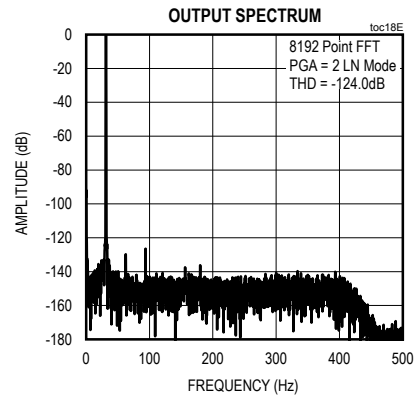
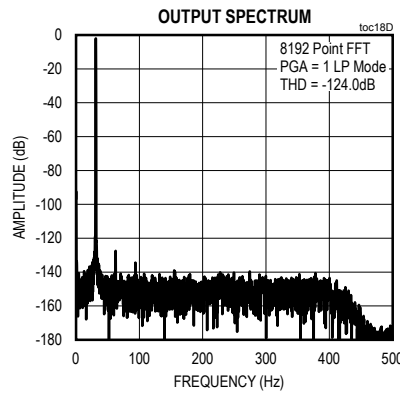
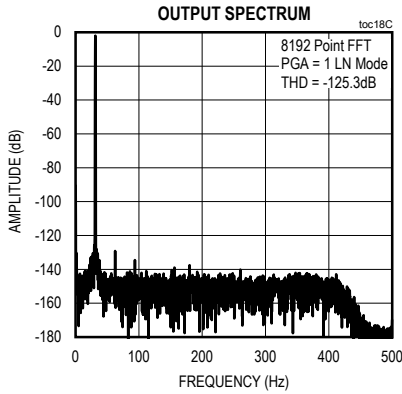

Pin Configuration

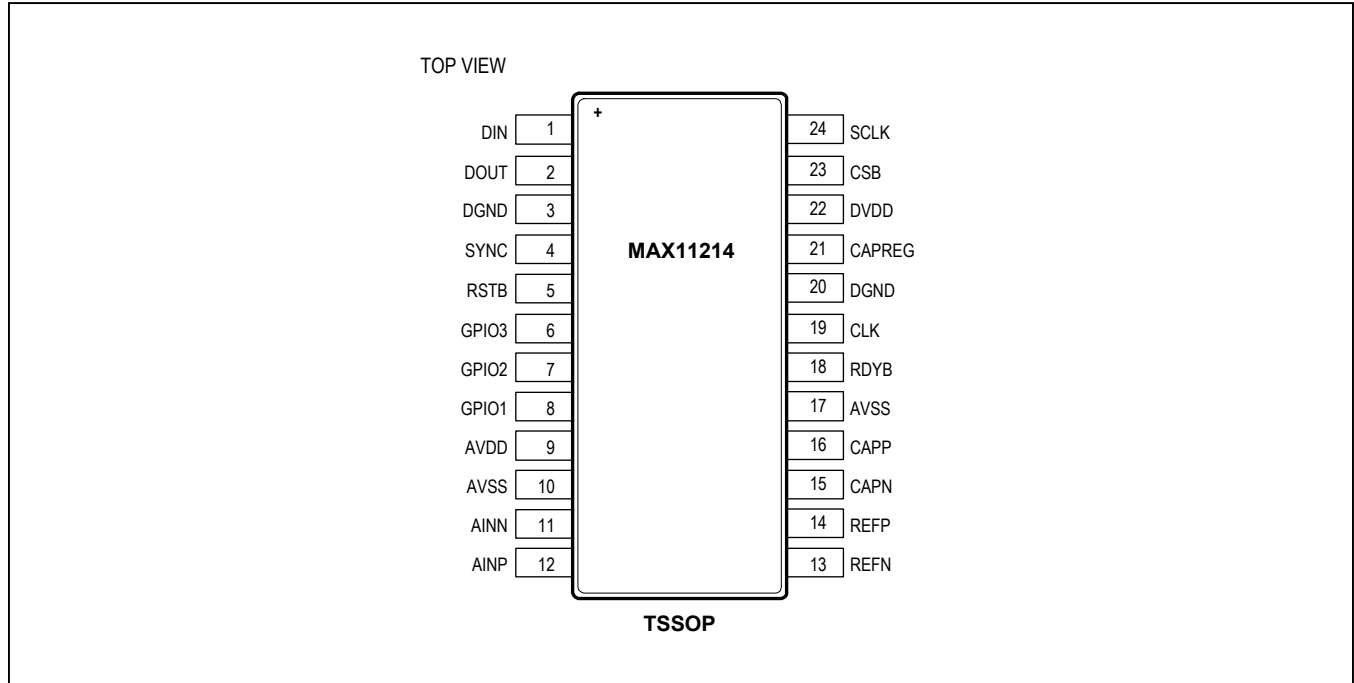

Pin Description

PIN	NAME	FUNCTION
1	DIN	Serial Data Input. Data is clocked into DIN on the rising edge of SCLK. DIN configures the internal register writes or a command operation.
2	DOUT	Serial Data Output or Real-Time Modulator MBO Output. DOUT outputs 32 or 24 bits of filtered data in normal data mode. DOUT transitions on the falling edge of SCLK.
3, 20	DGND	Digital Ground
4	SYNC	SYNC Reset. SYNC resets both the digital filter and the modulator.- Connect SYNC from multiple MAX11216s in parallel to synchronize more than one ADC to an external trigger. This is a digital input pin and is not internally pulled down. For normal operation drive or pull this pin low.
5	RSTB	The RSTB function is a complete reset of all digital functions resulting in a power-on reset default state. This is a digital input pin and is not internally pulled up. For normal operation drive or pull this pin high.
6	GPIO3	General-Purpose I/O 3 or Modulator Sync Output. GPIO3 is configurable as a digital input or output. GPIO pins have weak pull ups and do not require external bias if unused. For lowest power operation do not connect or drive high with GPIO configured as input (default).
7	GPIO2	General-Purpose I/O 2. Register controllable via SPI. GPIO pins have weak pull ups and do not require external bias if unused. For lowest power operation do not connect or drive high with GPIO configured as input (default).
8	GPIO1	General-Purpose I/O 1. Register controllable via SPI. GPIO pins have weak pull ups and do not require external bias if unused. For lowest power operation do not connect or drive high with GPIO configured as input (default).

## Pin Description (continued)

PIN	NAME	FUNCTION
9	AVDD	Analog Positive Supply Voltage. In single-supply mode, $V_{AVDD} = 2.7V$ to $3.6V$ with $V_{AVSS} = 0V$ . In dual-supply mode, AVDD and AVSS can range from $\pm 1.35V$ to $\pm 1.8V$ .
10, 17	AVSS	Analog Negative Supply Voltage. Connect AVSS to the most negative supply. Connect $V_{AVSS} = 0V$ in single-supply mode. Connect AVSS between $-1.8V$ and $0V$ for dual-supply mode.
11	AINN	Negative Analog Input. The analog inputs can measure both unipolar and bipolar ranges, depending on the AVDD and AVSS voltages.
12	AINP	Positive Analog Input. The analog inputs can measure both unipolar and bipolar ranges, depending on the AVDD and AVSS voltages.
13	REFN	Negative Reference Input. REFN must be less than REFP. REFN voltage must be between AVDD and AVSS.
14	REFP	Positive Reference Input. REFP must be greater than REFN. REFP voltage must be between AVDD and AVSS.
15	CAPN	PGA Filter Negative Capacitor Output. Connect a 10nF COG capacitor between CAPN and CAPP.
16	CAPP	PGA Filter Positive Capacitor Output. Connect a 10nF COG capacitor between CAPN and CAPP.
18	RDYB	Active-Low Data Ready Output or Internal Clock Output. RDYB asserts low when the data is ready. When in continuous conversion mode, a SYNC or POR event inhibits output of the first 4 data values to allow for filter settling when the SINC filter is selected. A SYNC or POR event inhibits output of the first 63 data values to allow for filter settling when using the FIR filters.
19	CLK	External Clock Input. For external clock mode, set the EXTCLK bit = 1 and provide a digital clock signal at CLK. The MAX11216 is specified with a clock frequency of 4.096MHz. Other clock frequencies may be used, but the data rate and digital filter notch frequencies will scale accordingly. This is a digital input pin and is not internally pulled down. When external clock is disabled drive this pin low.
21	CAPREG	Internal 1.8V Subregulator Reservoir Output. Bypass with a 10 $\mu$ F capacitor to DGND. Minimum capacitor value required for stability is 220nF.
22	DVDD	Digital Supply Voltage. Supply DVDD with 2.0V to 3.6V, with respect to DGND.
23	CSB	Active-Low Chip-Select Input. Set CSB low to access the serial interface. CSB is used for frame synchronization for communications when SCLK is continuous. Drive CSB high to reset the SPI interface.
24	SCLK	Serial Clock Input. Apply an external serial clock at SCLK to issue commands or access data from the MAX11216.



Functional Diagram

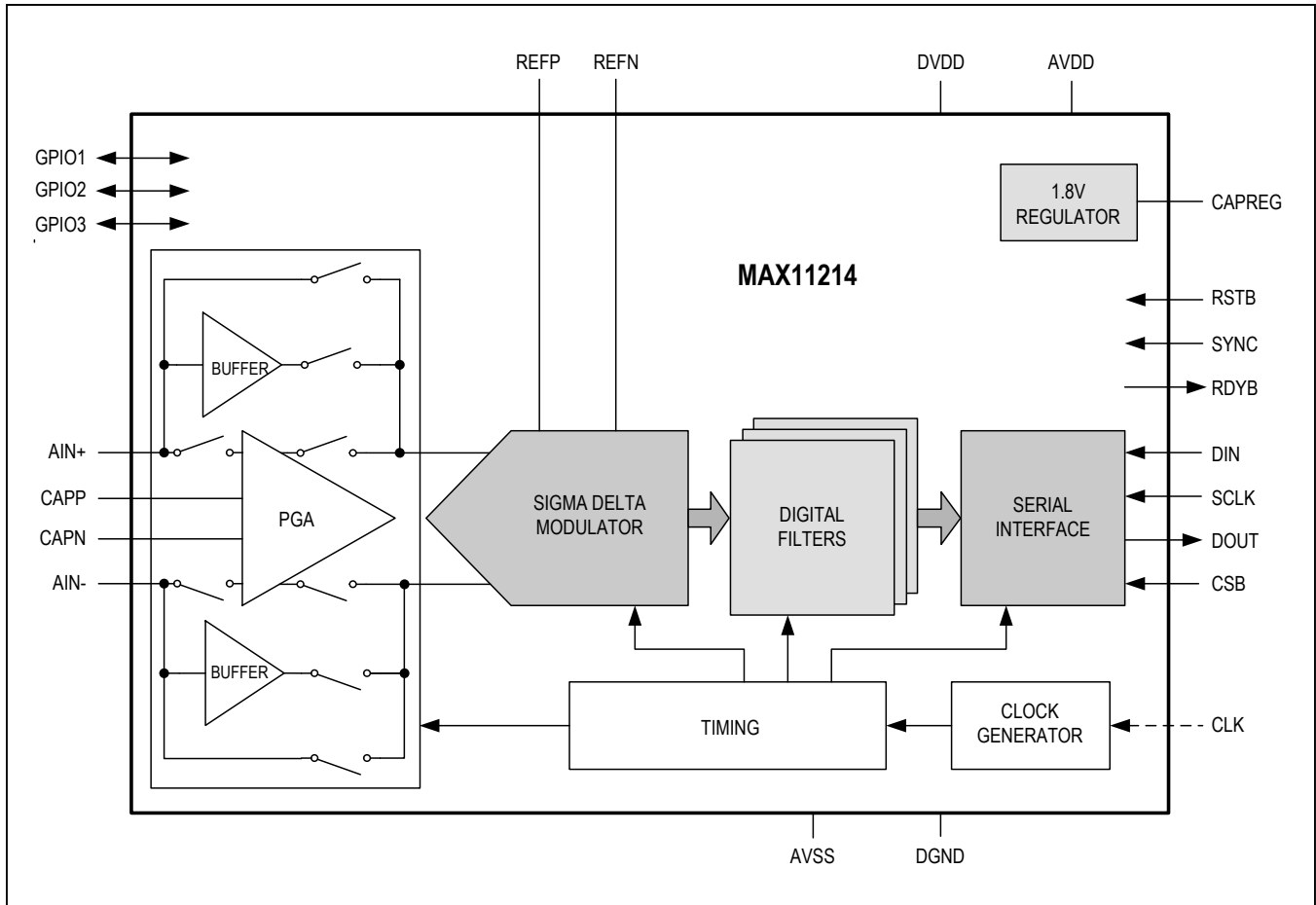

## Detailed Description

The MAX11214 is an ultra-low power ADC that resolves a very high dynamic range. This ADC is capable of resolving microvolt-level changes to the analog input, making it a good fit for seismic, instrumentation, and ATE applications. The user can select between programmable gain amplifier, unity-gain buffer or connect directly to the delta-sigma sampling network.

The MAX11214 includes a high-accuracy internal oscillator that requires no external components. Data is output through a serial interface at sample rates up to 8ksps with no data latency and 32ksps maximum. The MAX11214 has 3 digital filters SINC, FIR, and IIR. The fifth order SINC is always enabled. The FIR filter can be enabled to get a very flat passband response with extremely sharp cut-off and high stopband rejection. A programmable IIR highpass filter is also available for rejecting DC and low-frequency signals.

The MAX11214 is highly configurable via the internal registers, which can be accessed via the SPI interface. This includes PGA gain selection, digital filter selection, offset and gain calibration, and a scalable sample rate to optimize performance.

### System Clock

The MAX11214 incorporates a highly stable internal oscillator that provides the system clock. The system clock is trimmed to 4.096MHz and is divided further down to run the digital and analog timing.

### Voltage Reference Inputs

The MAX11214 provide differential inputs REFP and REFN for an external reference voltage. Connect the external reference directly across the REFP and REFN pins to obtain the differential reference voltage. The  $V_{REFP}$  should always be greater than  $V_{REFN}$  and the common-mode voltage range is between 1V and  $V_{AVDD} - 1V$ .

### Analog Inputs

The MAX11214 measures a pair of differential analog inputs (AINP, AINN) in buffered, direct connect or PGA. See the [Control 2 Register \(Read/Write\)](#) section for programming and enabling the PGA, buffers, or direct connect. The default configuration is direct connect, with both PGA and input buffers powered down.

### Input Buffers

The input buffer isolates the inputs from the capacitive load presented by the modulator, allowing for high source-impedance analog transducers.

### Bypass/Direct Connect

The MAX11214 offers the option to bypass both buffers and PGA and route the analog inputs directly to the modulator. This option lowers the power of the part since both buffers and PGA are shut off.

### Programmable Gain Amplifier (PGA)

The integrated PGA provides gain settings from 1x to 128x. See the *CTRL2 Register* section for enabling and programming the PGA. The PGA configuration is shown in [Figure 1](#). Direct connection is available to bypass the PGA enabling direct connection to the modulator. The PGA's absolute input voltage range is  $CMIRNG$  and the PGA output voltage range is  $VOUT_{RNG}$  as specified in the [Electrical Characteristics](#). The PGA output common-mode voltage is the same as the input common-mode voltage.

Note that linearity and performance degrade when the usable input common-mode voltage of the PGA is exceeded. The usable input common-mode range and output common-mode range are shown in [Figure 2](#). The following equations describe the relationship between the analog inputs and PGA output.

AINP = Positive input to the PGA

AINN = Negative input to the PGA

CAPP = Positive output of PGA

CAPN = Negative output of PGA

$V_{CM}$  = Input common mode

GAIN = PGA gain

$V_{REF}$  = ADC reference input voltage

$V_{IN} = V_{AINP} - V_{AINN}$

**Note:** Input voltage range is limited by the reference voltage as described by  $V_{IN} \leq \pm V_{REF}/GAIN$

$$V_{CM} = \frac{(V_{AINP} + V_{AINN})}{2}$$

$$V_{CAPP} = V_{CM} + GAIN \times (V_{AINP} - V_{CM})$$

$$V_{CAPN} = V_{CM} - GAIN \times (V_{CM} - V_{AINN})$$

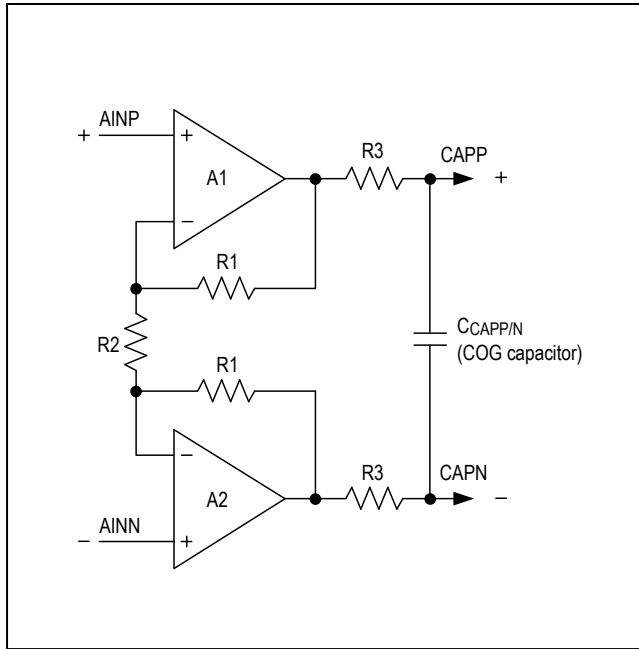

Figure 1. PGA Structure

**Input Voltage Range**

The ADC input range is programmable for bipolar ( $-V_{REF}$  to  $+V_{REF}$ ) or unipolar (0 to  $V_{REF}$ ) ranges. The U/B bit in the CTRL1 register configures the MAX11214 for unipolar or bipolar transfer functions. See Figure 2.

**Noise Performance vs. Data Rate**

The MAX11214 offers software-selectable output data rates in order to optimize data rate and noise. The RATE bits in the command byte determines the ADC's output data rate. The MAX11214 offers zero latency in single-cycle conversion mode. Set SCYCLE = 0 in the CTRL1 register to run in continuous conversion mode and SCYCLE = 1 for single-cycle conversion mode.

Single-cycle conversion mode gives an output result with no data latency for up to 6.4ksps. In continuous conversion mode, the maximum output data rate is 32ksps. In continuous conversion mode, the output data requires four additional 24-bit cycles to settle from an input step. For optimal SNR vs. power, it is recommended to use different PGA modes. For gain settings 8 and below, use low-power PGA mode, for gain setting above 8, use low-noise PGA mode.

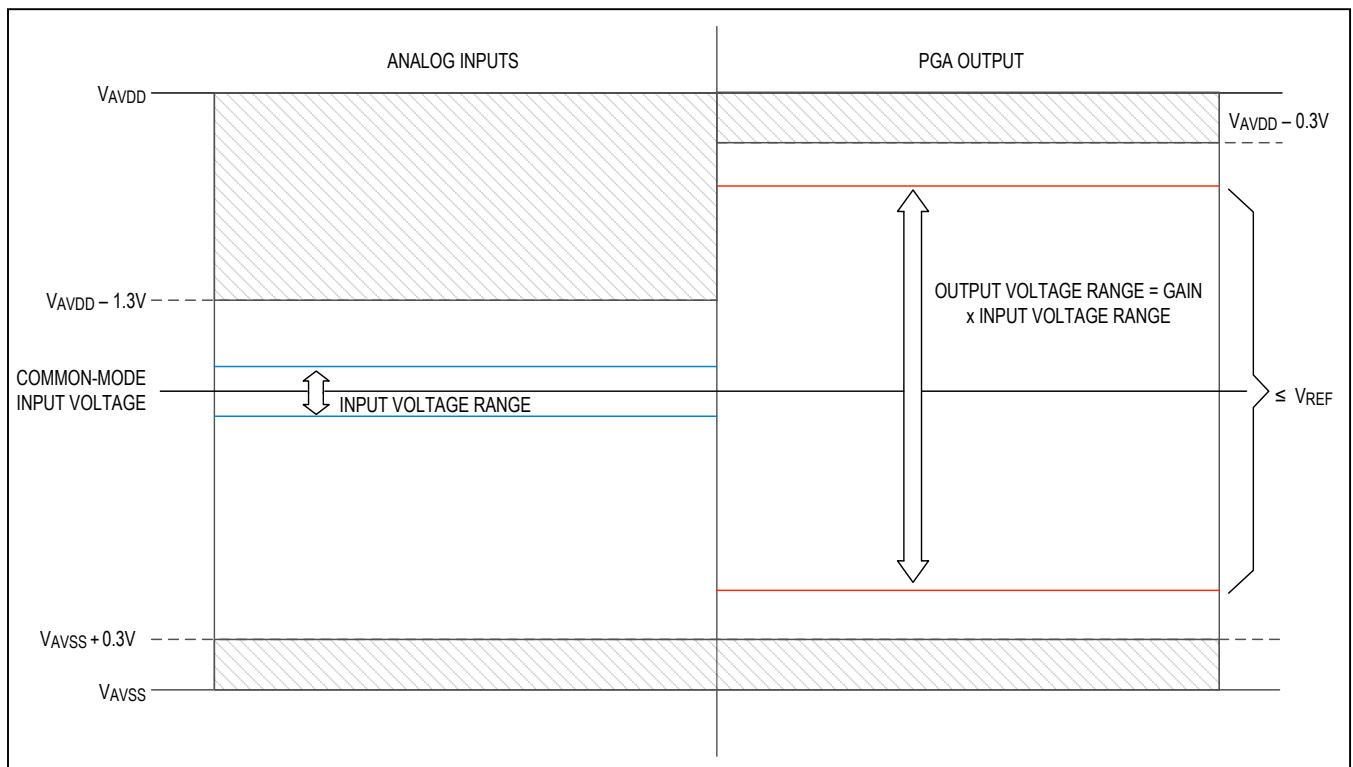

Figure 2. Usable Input and Output Common-Mode Range

**Table 1. Continuous Mode SNR vs Data Rate and PGA Gain with FIR Filter\***

DATA RATE (sps)	DIRECT CONNECT	BUFFER	PGA ENABLED: GAIN SETTING															
			1		2		4		8		16		32		64		128	
			LN	LP	LN	LP	LN	LP	LN	LP	LN	LP	LN	LP	LN	LP	LN	LP
62.5	131.3	130.4	125.7	125.6	129.1	128.2	129.9	129.8	129.6	127.9	127.8	125.7	124.4	122.4	119.4	116.7	112.7	110.1
125	129.2	128.0	123.7	123.0	126.4	126.0	128.0	127.7	126.5	126.3	125.0	124.1	121.9	119.3	116.6	113.5	110.1	107.0
250	126.8	126.1	121.1	121.0	124.0	124.1	125.0	124.8	124.2	123.5	122.5	120.6	119.1	116.2	113.6	111.1	107.7	104.2
500	124.0	123.4	118.6	118.4	121.6	121.5	122.4	122.0	121.0	120.7	119.6	117.7	115.7	113.2	110.5	107.6	104.4	101.1
1000	121.1	120.3	115.4	115.3	118.6	118.6	119.5	119.2	118.4	117.8	116.5	114.9	112.9	110.4	107.7	104.7	101.3	98.4
2000	118.1	117.5	112.6	112.5	115.7	115.7	116.7	116.3	115.6	114.9	113.4	111.8	109.7	107.3	104.5	101.8	98.4	95.3
4000	115.1	114.3	109.6	109.7	112.8	112.6	113.6	113.3	112.6	111.9	110.5	108.8	106.8	104.3	101.6	98.7	95.3	92.3
8000	112.1	111.4	106.6	106.5	109.7	109.6	110.6	110.3	109.6	108.8	107.6	105.8	103.7	101.3	98.6	95.7	92.4	89.3

\* $V_{IN} = 0V$ ,  $V_{AVDD} = 3.6V$ ,  $V_{AVSS} = 0V$ ,  $V_{REF} = 3.6V$ ,  $T_A = +25^{\circ}C$ , external clock. Data taken with PGA output 150mV from AVDD and AVSS. This table is not tested and is based on characterization data.

**Table 2. Continuous Mode Input Referred Noise ( $\mu V_{RMS}$ ) vs Data Rate and PGA Gain with FIR Filter\***

DATA RATE (sps)	DIRECT CONNECT	BUFFER	PGA ENABLED: GAIN SETTING															
			1		2		4		8		16		32		64		128	
			LN	LP	LN	LP	LN	LP	LN	LP	LN	LP	LN	LP	LN	LP	LN	LP
62.5	0.697	0.705	0.701	0.716	0.348	0.385	0.186	0.188	0.098	0.120	0.062	0.080	0.047	0.059	0.041	0.057	0.042	0.057
125	0.884	0.925	0.890	0.964	0.476	0.489	0.233	0.239	0.140	0.144	0.086	0.095	0.063	0.085	0.058	0.082	0.057	0.081
250	1.170	1.159	1.197	1.211	0.623	0.621	0.327	0.336	0.183	0.198	0.115	0.143	0.087	0.121	0.081	0.108	0.075	0.113
500	1.606	1.579	1.592	1.639	0.829	0.838	0.442	0.460	0.263	0.274	0.161	0.198	0.128	0.172	0.116	0.161	0.110	0.161
1000	2.250	2.245	2.296	2.343	1.160	1.168	0.618	0.639	0.355	0.383	0.229	0.274	0.178	0.238	0.160	0.225	0.157	0.220
2000	3.169	3.126	3.182	3.200	1.626	1.627	0.853	0.892	0.490	0.533	0.327	0.393	0.257	0.337	0.231	0.317	0.219	0.312
4000	4.472	4.479	4.473	4.462	2.278	2.319	1.216	1.257	0.697	0.756	0.458	0.551	0.360	0.477	0.323	0.453	0.313	0.442
8000	6.301	6.283	6.375	6.440	3.254	3.277	1.711	1.782	0.980	1.076	0.640	0.782	0.511	0.671	0.459	0.636	0.437	0.624

\* $V_{IN} = 0V$ ,  $V_{AVDD} = 3.6V$ ,  $V_{AVSS} = 0V$ ,  $V_{REF} = 3.6V$ ,  $T_A = +25^{\circ}C$ , external clock. This table is not tested and is based on characterization data.

**Table 3. Continuous Mode SNR (dB) vs Data Rate and PGA Gain with Sinc Filter\***

DATA RATE (sps)	DIRECT CONNECT	BUFFER	PGA ENABLED: GAIN SETTING															
			1		2		4		8		16		32		64		128	
			LN	LP	LN	LP	LN	LP	LN	LP	LN	LP	LN	LP	LN	LP	LN	LP
0.95	140.4	138.8	137.1	136.8	137.2	137.1	140.3	138.6	139.3	139.2	138.7	138.2	138.5	133.9	134.2	132.8	130.4	125.7
1.95	140.2	138.2	136.3	134.4	137.1	137.0	139.2	138.5	139.2	139.0	138.1	136.8	136.7	133.4	131.9	130.2	128.0	124.3
3.9	138.7	138.1	133.4	133.3	136.5	136.4	138.1	138.0	138.5	137.2	136.8	136.5	134.8	130.6	131.3	127.7	124.7	121.2
7.8	138.0	137.1	131.6	131.5	135.1	135.0	136.9	135.7	135.4	135.3	135.3	132.5	131.0	128.5	127.3	124.9	122.0	119.0
15.6	134.0	134.6	129.5	129.4	133.2	133.1	134.5	133.0	133.4	132.3	132.0	131.4	129.4	126.4	124.1	121.5	117.5	116.8
31.25	132.9	132.3	127.6	127.4	130.3	130.2	131.4	130.8	131.4	129.8	129.4	128.4	126.2	124.5	121.7	119.1	116.0	112.5
62.5	130.6	129.9	125.0	125.0	128.6	128.4	129.8	129.5	128.3	128.2	127.3	125.2	123.1	121.9	119.0	115.8	113.0	109.1
125	128.4	127.8	122.9	122.6	126.3	125.9	126.7	126.7	126.3	125.8	124.2	122.7	120.7	118.9	115.4	112.9	110.1	106.2
250	125.5	125.4	120.5	120.1	123.5	123.2	124.3	124.3	123.6	122.7	121.4	120.1	118.1	115.5	112.6	109.8	106.8	103.6
500	123.4	122.7	117.8	117.8	121.0	120.9	121.8	121.7	120.7	120.1	118.9	117.0	115.1	112.8	110.0	107.1	104.1	100.8
1000	120.5	119.8	115.0	115.0	118.3	118.3	119.2	118.8	118.3	117.4	115.9	114.5	112.2	110.1	107.2	104.3	101.0	97.9
2000	118.2	117.3	112.4	112.5	115.6	115.6	116.6	116.2	115.6	114.7	113.4	111.7	109.8	107.3	104.5	101.6	98.3	95.3
4000	116.1	115.3	110.5	110.4	113.6	113.5	114.6	114.3	113.5	112.8	111.4	109.7	107.6	105.3	102.5	99.7	96.2	93.3
8000	114.9	114.3	109.4	109.3	112.5	112.4	113.5	113.2	112.4	111.7	110.3	108.7	106.6	104.2	101.4	98.7	95.2	92.1
16000	111.9	111.2	106.4	106.4	109.5	109.4	110.4	110.2	109.5	108.7	107.3	105.7	103.6	101.2	98.5	95.6	92.2	89.3
32000	108.4	107.6	102.8	102.8	105.9	105.8	106.9	106.7	106.1	105.3	104.2	102.6	100.7	98.3	95.6	92.8	89.4	86.5

\* $V_{IN} = 0V$ ,  $V_{AVDD} = 3.6V$ ,  $V_{AVSS} = 0V$ ,  $V_{REF} = 3.6V$ ,  $T_A = +25^{\circ}C$ , external clock. Data taken with PGA output 150mV from AVDD and AVSS. This table is not tested and is based on characterization data.

**Table 4. Continuous Mode Input-Referred Noise ( $\mu V_{RMS}$ ) vs. Data Rate and PGA Gain with Sinc Filter\***

DATA RATE (sps)	DIRECT CONNECT	BUFFER	PGA ENABLED: GAIN SETTING															
			1		2		4		8		16		32		64		128	
			LN	LP	LN	LP	LN	LP	LN	LP	LN	LP	LN	LP	LN	LP	LN	LP
0.95	0.243	0.267	0.188	0.196	0.137	0.136	0.056	0.068	0.032	0.031	0.018	0.019	0.009	0.016	0.008	0.009	0.006	0.009
1.95	0.249	0.287	0.209	0.259	0.137	0.141	0.064	0.068	0.032	0.033	0.019	0.022	0.012	0.017	0.010	0.012	0.007	0.011
3.9	0.297	0.290	0.292	0.291	0.148	0.148	0.073	0.073	0.035	0.041	0.022	0.023	0.014	0.023	0.011	0.016	0.011	0.016
7.8	0.321	0.326	0.357	0.358	0.174	0.174	0.083	0.096	0.050	0.049	0.024	0.036	0.022	0.029	0.017	0.022	0.015	0.021
15.6	0.508	0.434	0.457	0.455	0.216	0.216	0.109	0.130	0.063	0.072	0.039	0.041	0.026	0.037	0.024	0.033	0.024	0.026
31.25	0.574	0.564	0.564	0.581	0.303	0.302	0.155	0.167	0.080	0.096	0.051	0.058	0.038	0.047	0.032	0.043	0.029	0.043
62.5	0.755	0.747	0.760	0.756	0.369	0.376	0.188	0.195	0.114	0.110	0.066	0.084	0.055	0.063	0.044	0.063	0.041	0.064
125	0.967	0.952	0.967	1.010	0.483	0.503	0.269	0.269	0.144	0.152	0.094	0.112	0.073	0.089	0.066	0.088	0.057	0.089
250	1.344	1.259	1.282	1.333	0.659	0.687	0.353	0.353	0.195	0.216	0.130	0.151	0.098	0.132	0.091	0.125	0.083	0.121
500	1.726	1.719	1.742	1.747	0.886	0.896	0.471	0.480	0.272	0.292	0.174	0.215	0.138	0.180	0.123	0.172	0.114	0.166
1000	2.392	2.401	2.416	2.390	1.208	1.209	0.639	0.666	0.362	0.398	0.245	0.287	0.193	0.244	0.170	0.236	0.163	0.233
2000	3.138	3.175	3.236	3.230	1.644	1.650	0.862	0.896	0.490	0.542	0.327	0.395	0.255	0.339	0.231	0.322	0.221	0.312
4000	3.998	4.028	4.035	4.076	2.060	2.098	1.085	1.125	0.627	0.681	0.411	0.497	0.327	0.428	0.292	0.403	0.282	0.395
8000	4.569	4.486	4.611	4.634	2.354	2.372	1.233	1.276	0.706	0.765	0.464	0.564	0.367	0.482	0.329	0.454	0.317	0.452
16000	6.435	6.436	6.508	6.513	3.330	3.349	1.749	1.802	0.996	1.093	0.655	0.792	0.517	0.681	0.463	0.645	0.447	0.628
32000	9.729	9.739	9.815	9.874	5.017	5.056	2.634	2.692	1.473	1.600	0.947	1.132	0.723	0.956	0.644	0.889	0.615	0.862

\* $V_{IN} = 0V$ ,  $V_{AVDD} = 3.6V$ ,  $V_{AVSS} = 0V$ ,  $V_{REF} = 3.6V$ ,  $T_A = +25^\circ C$ , external clock. This table is not tested and is based on characterization data.

Table 5. Single-Cycle Mode SNR (dB) vs. Data Rate and PGA Gain with Sinc Filter\*

DATA RATE (sps)	DIRECT CONNECT	BUFFER	PGA ENABLED: GAIN SETTING															
			1		2		4		8		16		32		64		128	
			LN	LP	LN	LP	LN	LP	LN	LP	LN	LP	LN	LP	LN	LP	LN	LP
25	133.8	134.1	129.1	129.1	132.4	131.6	133.3	132.7	132.7	131.7	131.0	129.4	127.7	125.4	122.9	119.9	116.4	113.7
31.25	133.5	133.1	129.0	128.2	131.9	131.5	132.6	132.2	131.7	131.3	129.8	128.4	126.9	124.4	121.6	118.9	115.7	112.7
50	132.4	131.6	126.8	126.8	129.8	129.8	130.9	130.7	130.3	129.2	128.3	126.7	124.7	122.3	119.6	116.8	113.5	110.4
62.5	131.4	130.8	126.1	126.1	129.0	129.0	130.1	129.8	129.4	128.5	127.2	125.6	123.7	121.3	118.7	115.8	112.5	109.3
100	129.7	128.8	124.1	124.1	127.4	127.2	128.2	128.0	127.4	126.6	125.2	123.6	121.7	119.3	116.6	113.7	110.5	107.2
125	128.9	128.0	123.2	123.1	126.4	126.3	127.3	127.1	126.4	125.5	124.3	122.5	120.7	118.3	115.5	112.7	109.4	106.4
200	126.8	126.1	121.2	121.2	124.3	124.3	125.1	125.0	124.3	123.5	122.2	120.7	118.6	116.2	113.4	110.5	107.1	104.1
250	125.7	125.0	120.2	120.3	123.2	123.3	124.1	123.9	123.2	122.5	121.1	119.5	117.6	115.0	112.4	109.5	106.1	103.0
400	123.5	122.8	117.9	117.9	121.0	121.0	121.9	121.6	121.0	120.1	118.8	117.2	115.2	112.7	109.9	107.1	103.8	100.7
500	122.3	121.5	116.7	116.7	119.8	119.8	120.8	120.5	119.8	119.0	117.7	116.0	114.0	111.5	108.8	105.9	102.6	99.5
800	119.6	118.9	114.0	114.0	117.1	117.1	118.1	117.8	117.1	116.3	114.9	113.3	111.2	108.8	106.1	103.2	99.8	96.8
1000	118.1	117.4	112.6	112.6	115.6	115.6	116.6	116.3	115.6	114.8	113.5	111.8	109.8	107.3	104.6	101.7	98.4	95.3
1600	116.6	115.8	111.0	111.0	114.1	114.1	115.0	114.8	114.1	113.3	112.0	110.2	108.2	105.8	103.0	100.1	96.8	93.8
2000	115.1	114.3	109.5	109.5	112.6	112.6	113.6	113.3	112.6	111.8	110.5	108.8	106.8	104.3	101.6	98.7	95.4	92.3
3200	111.9	111.2	106.3	106.4	109.4	109.4	110.4	110.2	109.4	108.6	107.3	105.7	103.7	101.2	98.5	95.6	92.2	89.3
6400	108.6	107.8	103.1	103.1	106.1	105.9	107.0	106.4	105.8	104.7	103.7	102.1	100.3	97.5	95.1	91.4	88.6	82.8

\* $V_{IN} = 0V$ .  $V_{AVDD} = 3.6V$ ,  $V_{AVSS} = 0V$ ,  $V_{REF} = 3.6V$ ,  $T_A = +25^{\circ}C$ , external clock. Data taken with PGA output 150mV from AVDD and AVSS. This table is not tested and is based on characterization data.

**Table 6. Single-Cycle Mode Input-Referred Noise ( $\mu\text{VRMS}$ ) vs. Data Rate and PGA Gain with Sinc Filter\***

DATA RATE (sps)	DIRECT CONNECT	BUFFER	PGA ENABLED: GAIN SETTING															
			1		2		4		8		16		32		64		128	
			LN	LP	LN	LP	LN	LP	LN	LP	LN	LP	LN	LP	LN	LP	LN	LP
25	0.522	0.460	0.475	0.471	0.239	0.261	0.126	0.134	0.068	0.077	0.043	0.052	0.032	0.042	0.028	0.039	0.027	0.038
31.25	0.535	0.515	0.477	0.526	0.252	0.265	0.137	0.143	0.077	0.080	0.050	0.058	0.035	0.047	0.032	0.044	0.030	0.042
50	0.608	0.612	0.623	0.621	0.322	0.316	0.165	0.170	0.090	0.102	0.059	0.071	0.046	0.060	0.041	0.056	0.039	0.055
62.5	0.687	0.675	0.668	0.676	0.354	0.346	0.183	0.188	0.101	0.111	0.067	0.080	0.051	0.067	0.045	0.063	0.043	0.062
100	0.835	0.851	0.845	0.849	0.424	0.431	0.226	0.231	0.126	0.139	0.084	0.100	0.065	0.085	0.057	0.080	0.055	0.079
125	0.912	0.935	0.934	0.948	0.475	0.481	0.250	0.258	0.142	0.157	0.093	0.114	0.073	0.096	0.065	0.090	0.062	0.087
200	1.165	1.163	1.177	1.184	0.605	0.606	0.321	0.326	0.180	0.197	0.119	0.141	0.092	0.122	0.083	0.116	0.080	0.113
250	1.322	1.309	1.323	1.316	0.683	0.679	0.360	0.371	0.205	0.222	0.135	0.161	0.103	0.139	0.094	0.130	0.090	0.129
400	1.697	1.694	1.730	1.727	0.884	0.887	0.466	0.485	0.264	0.292	0.175	0.211	0.137	0.182	0.124	0.172	0.118	0.168
500	1.944	1.964	1.979	1.965	1.010	1.020	0.529	0.549	0.302	0.332	0.199	0.242	0.156	0.208	0.141	0.196	0.136	0.193
800	2.674	2.658	2.701	2.697	1.383	1.391	0.726	0.749	0.414	0.453	0.273	0.332	0.217	0.285	0.193	0.269	0.186	0.264
1000	3.156	3.165	3.194	3.196	1.639	1.649	0.862	0.888	0.491	0.541	0.323	0.393	0.255	0.339	0.229	0.321	0.220	0.313
1600	3.775	3.771	3.812	3.823	1.950	1.956	1.030	1.058	0.584	0.640	0.385	0.469	0.304	0.403	0.275	0.382	0.263	0.373
2000	4.483	4.476	4.522	4.530	2.319	2.332	1.212	1.261	0.691	0.762	0.455	0.556	0.360	0.479	0.324	0.451	0.311	0.440
3200	6.435	6.448	6.544	6.523	3.343	3.342	1.749	1.801	0.998	1.094	0.656	0.795	0.515	0.683	0.461	0.644	0.446	0.627
6400	9.469	9.484	9.512	9.504	4.911	5.024	2.599	2.789	1.515	1.719	0.998	1.196	0.759	1.042	0.681	1.043	0.677	1.323

\* $V_{IN} = 0V$ ,  $V_{AVDD} = 3.6V$ ,  $V_{AVSS} = 0V$ ,  $V_{REF} = 3.6V$ ,  $T_A = +25^\circ\text{C}$ , external clock. Data taken with PGA output 150mV from AVDD and AVSS. This table is not tested and is based on characterization data.



**Power-On Reset**

The MAX11214 contains power-on reset (POR) supply monitoring circuitry on both the digital supply (DVDD) and the positive analog supply (AVDD). The POR circuitry ensures proper device default conditions after either a digital or analog power-sequencing event.

The digital POR trigger threshold is typically 1.2V with respect to  $V_{DGND}$  and has 100mV of hysteresis. The analog POR trigger threshold is typically 1.25V with respect to  $V_{AVSS}$  and has 100mV of hysteresis. Both POR circuits have lowpass filters that prevent high-frequency supply glitches from triggering the POR.

**Power-Down Modes**

The MAX11214 can be powered down via the IMPD bit in the command byte (see [Table 10](#)). The PD[1:0] bits of the CTRL1 register are used to select the power-down state. The SPI remains fully functional in all power-down states.

**Sleep Mode:** The sleep mode can be set by writing 01 to the PD[1:0] bits. In this state the internal subregulator that powers the digital core is powered off. This is the lowest power state for the device.

**Standby Mode (10):** The standby mode is set by writing 10 to the PD[1:0] bits. In this mode the device is not active, but the internal subregulator is still powered on. This allows conversions to start immediately after receiving a start conversion command (see [Table 10](#)).

**Table 7. MAX11214 Command Behavior from Pin (RSTB, SYNC) and SPI (RESET, SYNC\_SPI)**

COMMAND ISSUED	COMMAND-ISSUED VIA	STATE BEFORE COMMAND	STATE AFTER COMMAND	TRANSITION TIME (MAX)	COMMAND INTERPRETATION AND RESULTING CHIP STATE
RESET SPI or PIN	SPI, PIN	STBY	STBY	—	Chip POR
		SLEEP	STBY	5ms	Chip POR
		Calibration	STBY	—	Calibration stops, chip POR
		Conversion	STBY	—	Conversion stops, chip POR
IMPD CTRL1:PD='01' SLEEP Mode	SPI	STBY	SLEEP	—	Chip changes from STBY to SLEEP
		SLEEP	SLEEP	—	Chip remains in SLEEP
		Calibration	SLEEP	—	Calibrations stop
		Conversion	SLEEP	—	Conversion stop
IMPD CTRL1:PD='10' STBY Mode	SPI	STBY	STBY	—	Chip remains in standby
		SLEEP	STBY	—	Chip changes from SLEEP to standby
		Calibration	STBY	—	Calibrations stop, chip changes to standby
		Conversion	STBY	—	Conversions stop, chip changes to standby

**Table 7. MAX11214 Command Behavior from Pin (RSTB, SYNC) and SPI (RESET, SYNC\_SPI)  
(continued)**

COMMAND ISSUED	COMMAND- ISSUED VIA	STATE BEFORE COMMAND	STATE AFTER COMMAND	TRANSITION TIME (MAX)	COMMAND INTERPRETATION AND RESULTING CHIP STATE
SYNC	SPI, PIN	STBY	STBY	—	SYNC ignored, chip remains in STBY mode
		Calibration	Calibration	—	SYNC ignored
		Conversion	Conversion	—	Pulse SYNC mode, conversions restart
		Conversion	Conversion	—	Continuous SYNC mode, 1 <sup>st</sup> SYNC rising edge set clock counter, subsequent rising edges are compared against clock counter. If count is off by more than $\pm 1$ clock counts then restart conversions otherwise do nothing and continue conversions in progress. If a SYNC rising edge occurs before the first RDYB asserts after conversions are started then SYNC is ignored. Once the first RDYB asserts, all subsequent SYNC rising edges are evaluated.
CMD Register Write	SPI	STBY	STBY	—	Chip remains in standby
		SLEEP	SLEEP	—	Chip remains in SLEEP
		Calibration	STBY	—	Calibration stops, chip goes to STBY mode
		Conversion	STBY	—	Conversion stops, chip goes to STBY mode
Convert Command Write	SPI	STBY	Conversion	—	Exit standby, conversion starts
		SLEEP (SPI)	Conversion	—	Exit SLEEP mode, conversion starts
		Calibration	Conversion	—	Calibration stops then a new conversion starts
		Conversion	Conversion	—	Conversion stops and a new conversion starts

**Digital Filters**

The digital filter is a mode-configurable digital filter and decimator that processes a one-bit data stream from the fourth order delta-sigma modulator and implements a fifth order SINC function with an averaging function to produce a 24-bit wide data stream.

**SINC Filter**

The SINC filter allows MAX11214 to achieve very high SNR. One feature of the fifth order SINC filter is a bandwidth that is about twenty percent of the data rate. The

following example shows 3dB BW of about 1.5kHz for 8ksps data rate.

**FIR Filter**

The user can select the built-in FIR filter to expand the input bandwidth of MAX11214, thus achieving very low ripple passband with extremely sharp rolloff and high stopband rejection. This is done by selecting the FILT bits in the CTRL 3 register to enable the FIR filter. There are two different forms of FIR filter available, and the user can

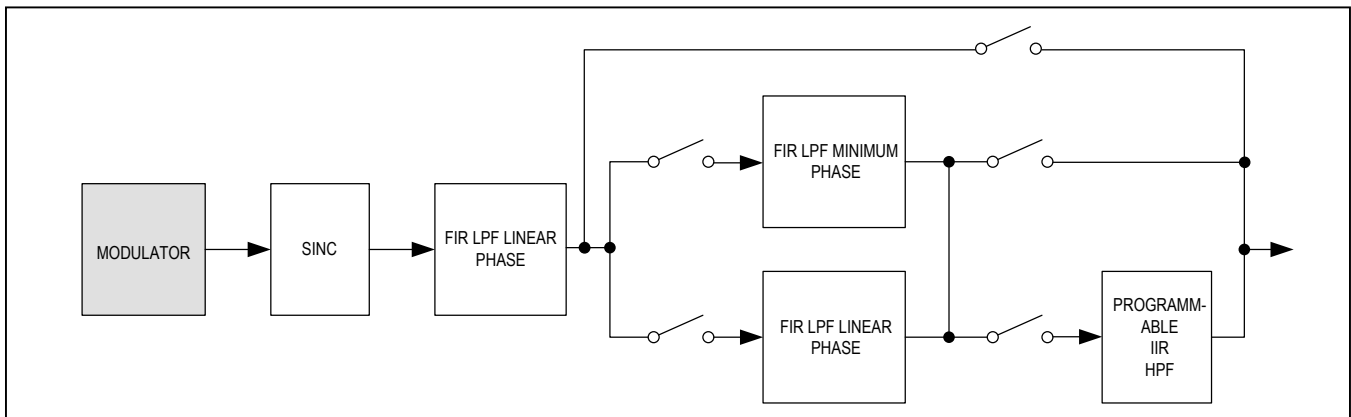

Figure 3. Digital Filter Path

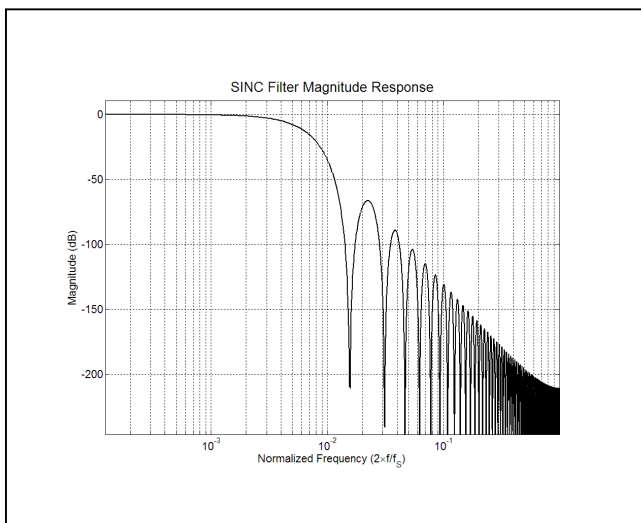

Figure 4a. SINC Magnitude Response

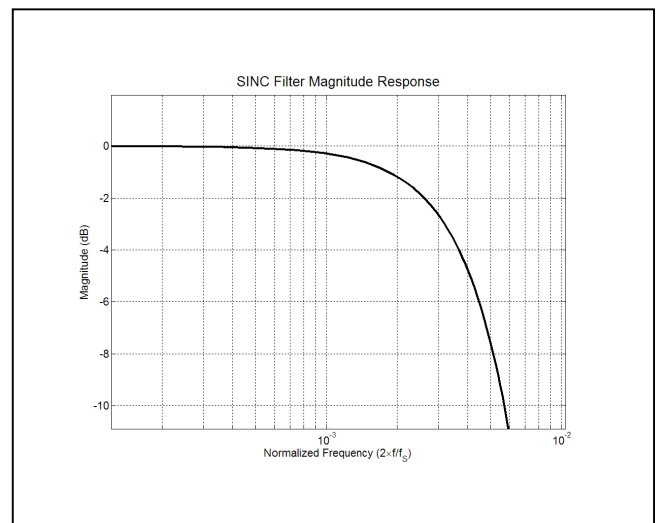

Figure 4b. SINC Mag Response Zoomed-In

select between linear phase response or minimum phase response by setting the PHASE bit in the CTRL 3 register. The magnitude response for FIR filter with linear phase and minimum phase at 8ksps data rate is shown below: The passband ripple is comparable in linear phase and minimum phase responses and is less than 5m dB.

Linear response FIR filter should be selected if the application requires linear phase relationship, otherwise for faster settling use minimum phase FIR filter. This is shown in the following phase response and step response plots. Note all plots are taken for 8ksps data rate.

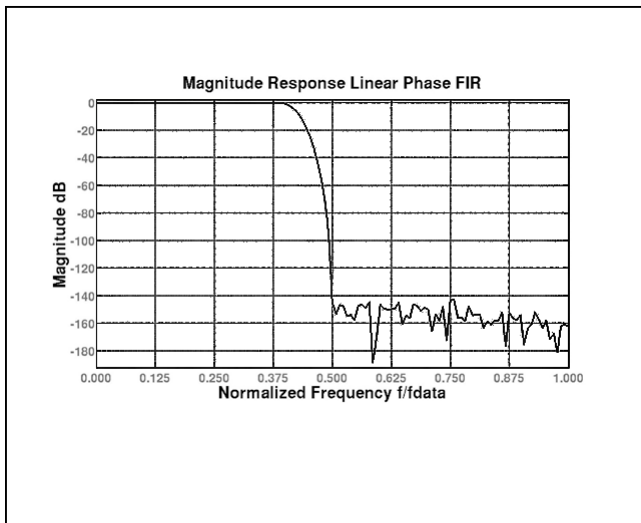

Figure 5. Magnitude Response, Linear Phase FIR, 8ksps Data Rate

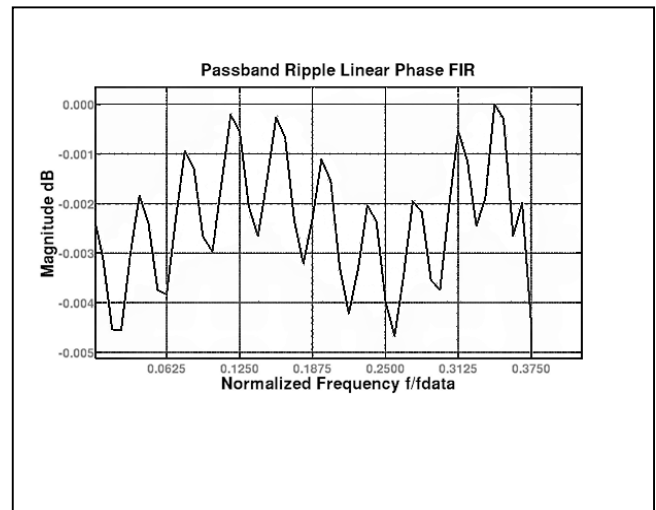

Figure 7. Passband Ripple, Linear Phase FIR, 8ksps Data Rate

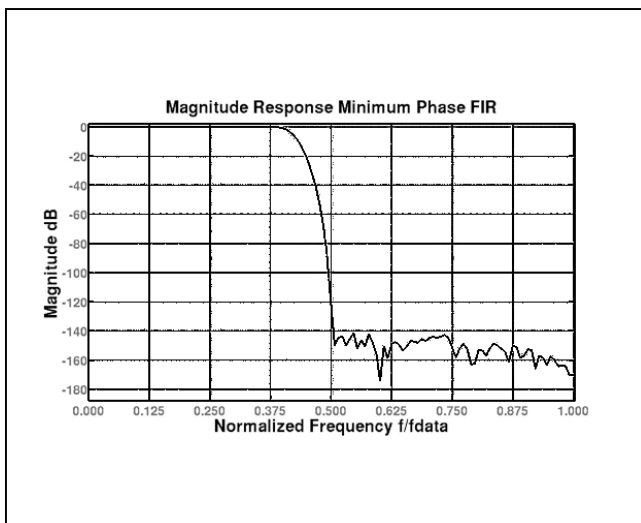

Figure 6. Magnitude Response, Minimum Phase FIR, 8ksps Data Rate

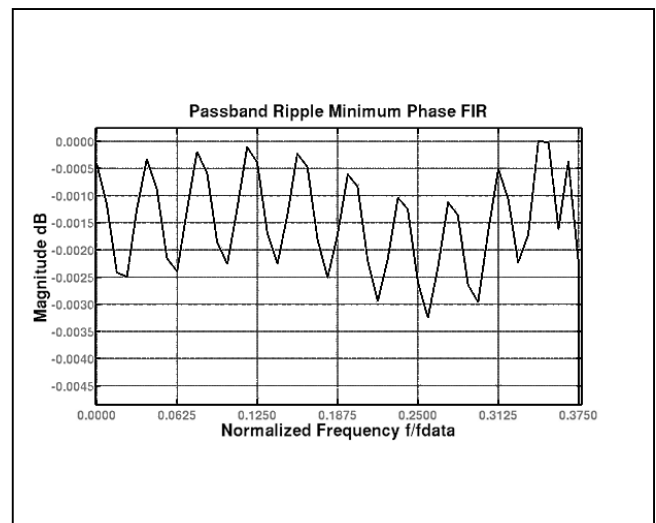

Figure 8. Passband Ripple, Minimum Phase FIR, 8ksps Data Rate

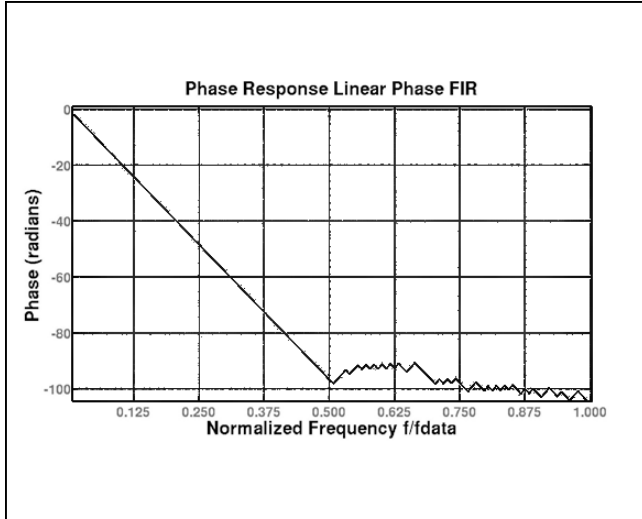

Figure 9. Phase Response, Linear Phase FIR, 8ksps Data Rate

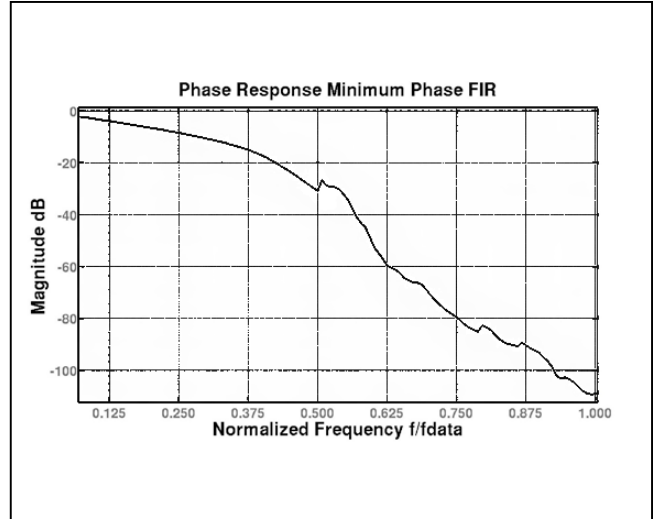

Figure 11. Phase Response, Minimum Phase FIR, 8ksps Data Rate

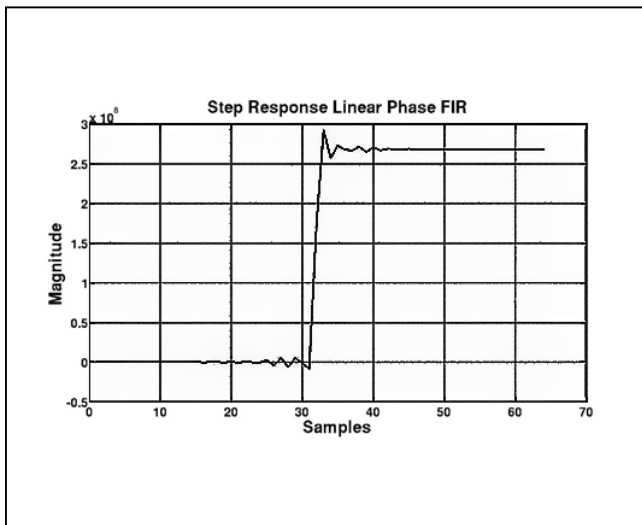

Figure 10. Step Response, Linear Phase FIR

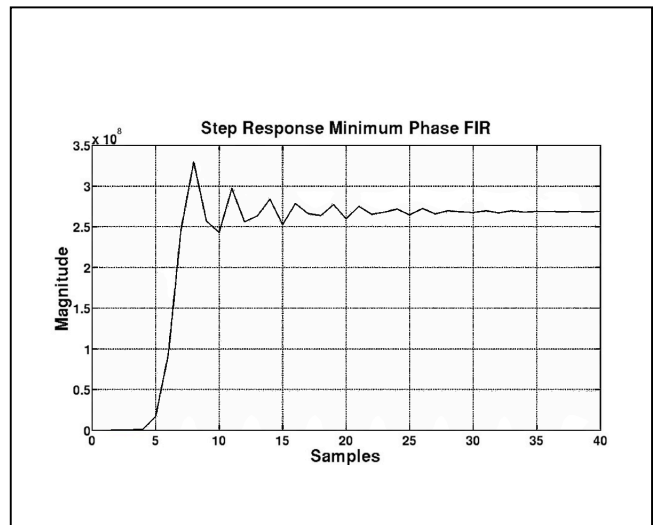

Figure 12. Step Response, Minimum Phase FIR

### Highpass Filter

The highpass filter in the MAX11214 has adjustable rolloff frequency and is used for DC or low-frequency removal from the output. The IIR option is enabled by setting the FILT bits to '11' in the CTRL3 register (see [Table 12](#)). The 16-bit highpass filter configuration register HPF configures the corner frequency of the IIR (infinite impulse response) digital filter.

The transfer function for the IIR filter in z-domain is given by

$$HPF(Z) = \frac{2-a}{2} \times \frac{1-Z^{-1}}{1-b \cdot Z^{-1}}$$

where b is calculated from:

$$b = \frac{1+(1-a)^2}{2}$$

The ideal HPF gain response is:

$$|HPF| = \frac{1 + \sqrt{1 - 2 \left( \frac{\cos w_N + \sin w_N - 1}{\cos w_N} \right)}}{2 - \left( \frac{\cos w_N + \sin w_N - 1}{\cos w_N} \right)}$$

where the normalized 3dB corner frequency is given by:

$$w_N = 2\pi \frac{f_{HP}}{f_S}$$

$f_{HP}$  is the highpass cutoff frequency and  $f_S$  is the data rate.

To solve for the programmable register HPF value, use:

$$HPFR_{[15:0]} = 65536 \times \left( 1 - \sqrt{1 - 2 \left( \frac{\cos w_N + \sin w_N - 1}{\cos w_N} \right)} \right)$$

Using the maximum Highpass Filter Register value typically gives 3dB rolloff equivalent to one tenth of the data rate. Note that not all values are allowed. [Table 8](#) shows what maximum values HPF[15:0] can take for different data rates.

[Table 9](#) shows a few examples of calculations for 3dB corner frequency.

**Table 8. Max HPF[15:0] Register Values for Different Data Rates**

CASE	FHP	DATA RATE	HPF[15:0] MAX VALUE
1	25	250	56492
2	102	1000	61787
3	204	2000	61787
4	409	4000	63164

**Table 9. Examples of HPF[15:0] Register Values and Cutoff Frequencies**

CASE	-3dB CORNER FREQUENCY (Hz)	HPF[15:0]
1	0.002Fs	823 (decimal)
2	0.001Fs	410 (decimal)
3	0.0005Fs	203 (decimal)

**Serial Interface**

The MAX11214 interface is fully compatible with SPI, QSPI™, and MICROWIRE®-standard serial interfaces. The SPI interface provides access to on-chip registers that are 8 bits to 24 bits wide.

**Chip Select (CSB)**

CSB is an active-low chip-select input to communicate with the MAX11214. CSB transitioning from low to high is used to reset the SPI interface. When CSB is low, data is clocked into the device from DIN on the rising edge of SCLK. Data is clocked out of DOUT on the falling edge of SCLK. When CSB is high, SCLK and DIN are ignored and DOUT is high impedance allowing DOUT to be shared with other devices.

**SCLK (Serial Clock)**

The serial clock (SCLK) is used to synchronize data communication between the host device and the MAX11214. Data is shifted in on the rising edge of SCLK and data is shifted out on the falling edge of SCLK. SCLK remains low when not active.

**DIN (Serial Data Input)**

Data present on DIN is clocked into internal registers on the rising edge of SCLK.

**DOUT (Serial Data Output)**

The DOUT pin is actively driven when CSB is low and high impedance when CSB is high. Data are shifted out on DOUT on the falling edge of SCLK.

**Data Ready (RDYB)**

The RDYB output displays the conversion status. RDYB is forced low when a conversion result is ready for read-out and remains low until the user reads the conversion result. RDYB returns high after SCLK is pulled high, following a complete read of the data register. RDYB also resets high for 4 master clock cycles prior to DATA register update (see Figure 13).

When the modulator is in one of the continuous operating modes and the part has either experienced a RESET, SYNC, or POR event, then the RDYB pin will remain high until the selected filter is settled. If the SINC filter is selected then RDYB remains high for five  $t_{CNV}$  times and afterwards data appears at each  $t_{CNV}$ .

The conversion status can also be determined by reading the MSTAT bit in the STAT1 register.

QSPI is a trademark of Motorola, Inc.  
MICROWIRE is a registered trademark of National Semiconductor Corp.

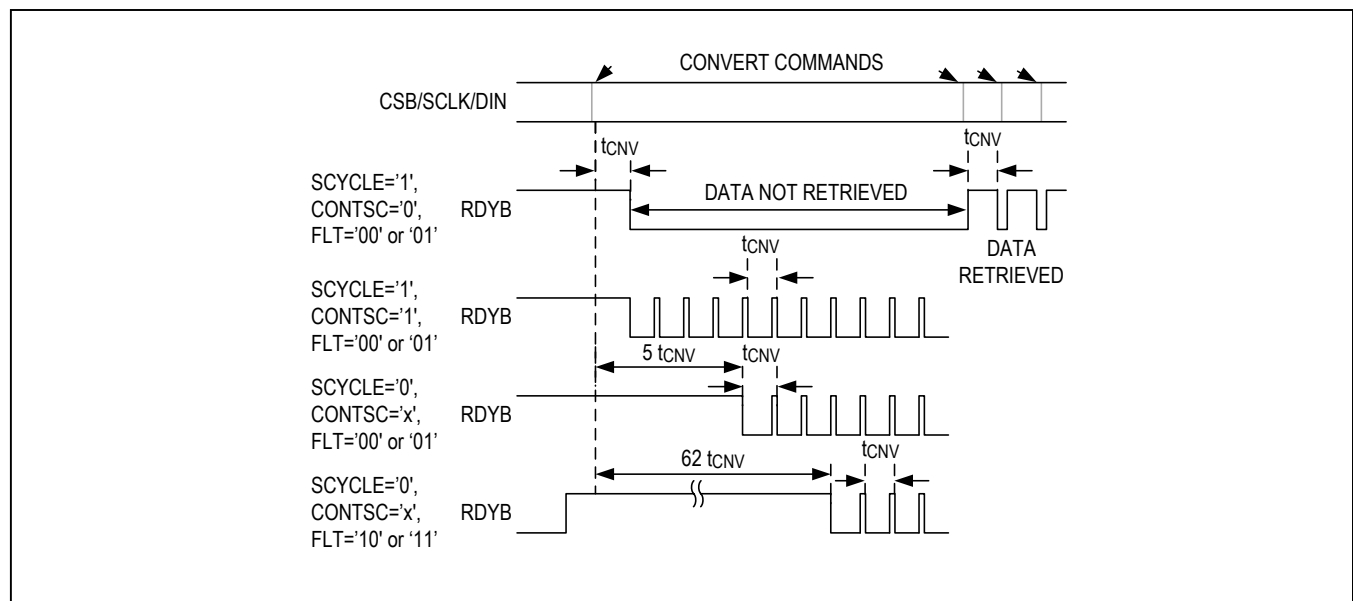

Figure 13. DATA Ready Timing for All Conversion Modes

**SPI Incomplete Write Command Termination**

In case of register writes, the register values get updated every 8th clock cycle with a byte of data starting from the MSB. A minimum of 16 SCLKs are needed to write the first byte of data in a multibyte register or for an 8-bit register. For example, a 24-bit register write requires 8 SCLKs for register access byte and 24 SCLKs (data bits to be written). If only 15 SCLKs were issued out of 32 expected, the register value will not be updated. At least 16 SCLKs are required to update the MSB byte. For example, when the user issues a write command for a 24-bit register write and terminates after 16 SCLKs, only the MSB byte, bits 23 to 16 of the register are updated. Bits 15 to 0 retain the old value of the register.

**SPI Incomplete Read Command Termination**

The SPI interface stays in read mode for as long as CSB stays low independent of the number of SCLKs issued. The CSB pin must be toggled high to remove the device from the bus and reset the internal SPI controller. Any activity on the DIN pin is ignored while in the register read mode. The read operation is terminated if the CSB pin is toggled high before the maximum number of SCLK is issued.

When reading from DATA registers, the behavior of RDYB will depend on how many bits are read. If at least 23 bits are read, the read operation is complete and RDYB resets to high. If the user reads less than 23 bits, internally the logic considers the read incomplete, and RDYB stays low. The user can initiate a new read within the same conversion cycle and the new 24-bit read must complete before the next DATA register update.

**SPI Timing Characteristics**

The SPI timing diagrams illustrating command byte and register access operations are shown in [Figures 14 to 17](#). The MAX11214 timing allows for the input data to be changed by the user at both rising and falling edges of SCLK. The data read out by the device on SCLK falling edges can be sampled by the user on subsequent rising or falling edges.

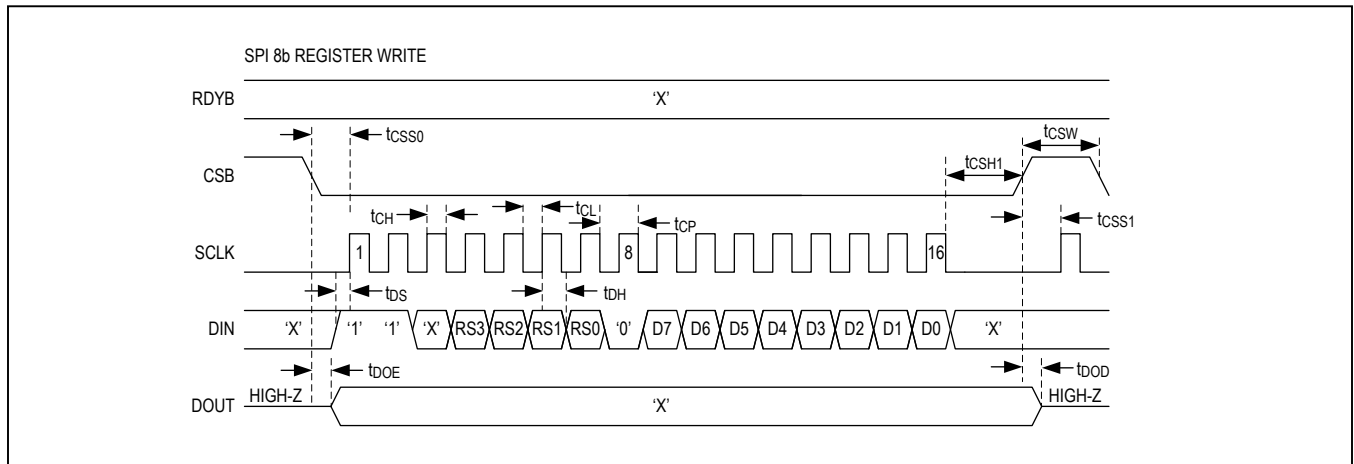

Figure 14. SPI Register Write Timing Diagram



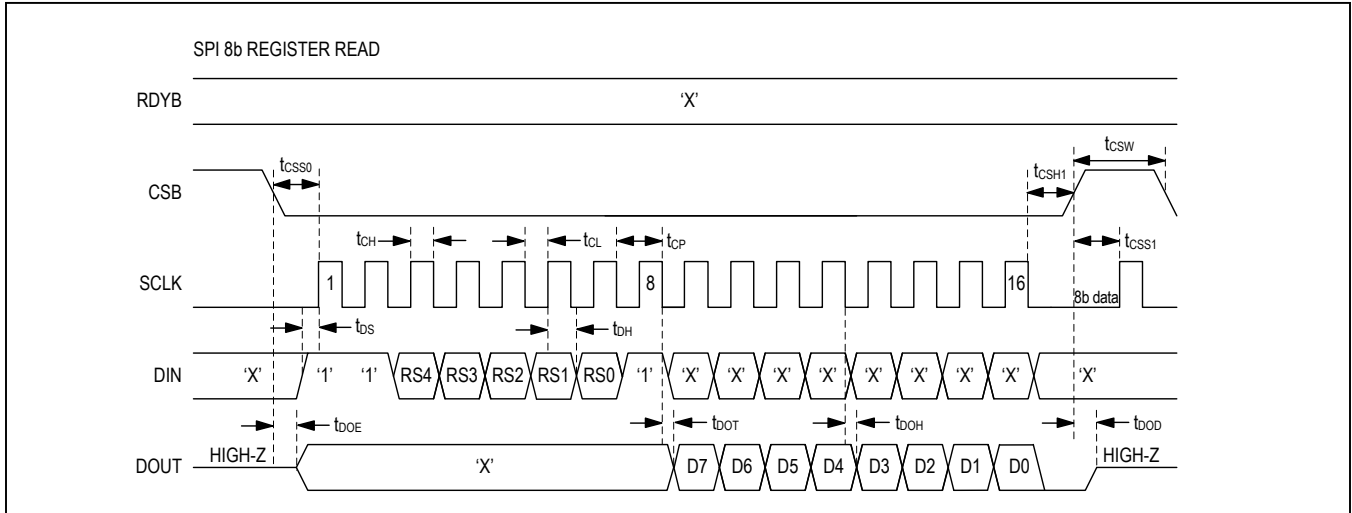

Figure 15. SPI Register Read Timing Diagram

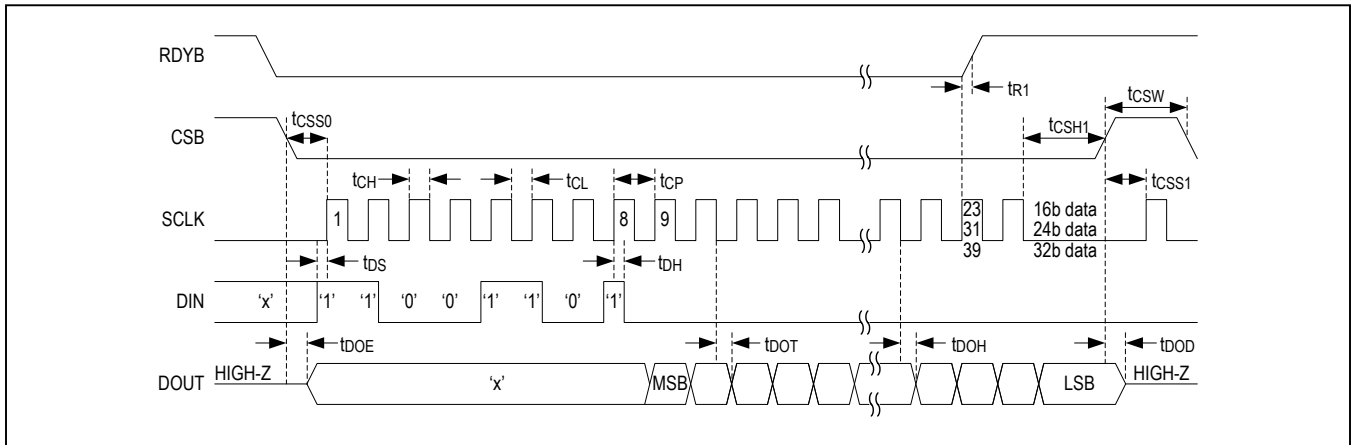

Figure 16. SPI Data Readout Timing Diagram

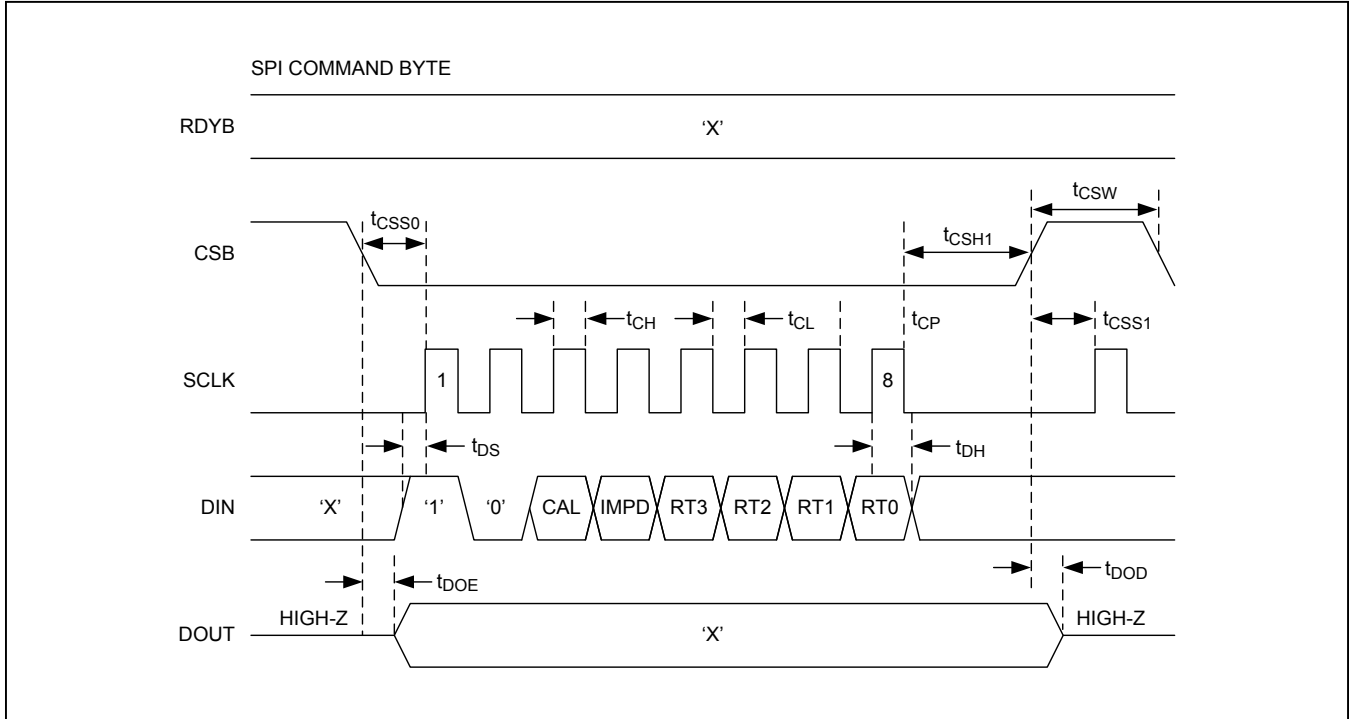

Figure 17. SPI Command Byte Timing Diagram

## Modes and Registers

The MAX11214 interface operates in two modes, conversion mode or register access mode, which is selected by the command byte. Every SPI transaction to the MAX11214 starts with a command byte. The command byte begins with a START bit (B7), which must be set to 1. The next bit is the MODE bit (B6), which selects between conversion mode or register access mode. Based on the mode selection the remaining bits in the command byte get decoded accordingly.

If the command byte is for a register read/write request, hold CSB low for the entire read or write operation and pull CSB high at the end of the command. For example, if the command is to read a 24-bit data register; hold CSB low for 32 SCLK cycles (8 cycles of command plus 24 cycles of data). CSB transitions must not occur near the rising edge of SCLK and must conform to the setup and hold timing detailed in the timing section.

Pulling CSB from low to high ends the current SPI transaction. If CSB is pulled high in the middle of a register write command, the registers will retain any partially written data. This does not cause a change in state of any internal register that was being accessed for read or write

### Conversion Mode (MODE = 0)

**Table 10. Command Byte for Conversion Modes (MODE = 0)**

BIT	B7 (MSB)	B6	B5	B4	B3	B2	B1	B0
BIT NAME	START = 1	MODE = 0	CAL	IMPD	RATE3	RATE2	RATE1	RATE0

Set the MODE bit to 0 to: start a conversion with a rate defined by RATE[3:0], immediately power down the part or perform a calibration.

The CAL bit (B5) determines if a calibration is to be performed. Set CAL = 1 to perform a calibration, for all other operations set CAL = 0. The calibration is done based on the setting of the calibration bits CTRL 5. Also see discussion on calibration in the following sections.

The IMPD bit (B4) controls the software power-down. Set IMPD = 1 to power down the MAX11214 and enter sleep mode or standby mode, based on the setting of the PD Bits in CTRL1, once the command byte is complete. The power-down status does not change until another command byte is received that is interpreted as a conversion byte (MODE = 0, IMPD = 0). Set IMPD = 0 for normal operation.

The data rate bits RATE[3:0] determine the conversion speed. The speed table is shown later in [Table 13](#).

### Register Access Mode (MODE = 1)

**Table 11. Command Byte for Register Access Mode (MODE = 1)**

BIT	B7 (MSB)	B6	B5	B4	B3	B2	B1	B0
BIT NAME	START = 1	MODE = 1	RS4	RS3	RS2	RS1	RS0	R/W

MODE 1 or Register Access Mode is used for reading from and writing to the registers of the MAX11214. Set the MODE bit (B6) = 1 to configure the command byte for Register Access Modes.

The bits RS[4:0] determine the register that is addressed as shown in [Table 12](#).

The R/W bit enables either a read or a write of the register. Set R/W = 0 to write to the selected register and R/W = 1 to read from the selected register.

## Register Map

### Register Address Map

There are 14 registers that can be accessed in the MAX11214. The majority of registers can be both written to and read from, but the STAT and DATA registers are read only. The RAM and SYNC are not physical registers, but addresses to enable special operating modes.

**Table 12. Register Address Map**

REGISTER NAME	R/W	ADDRESS SELECT RS[3:0]	B7	B6	B5	B4	B3	B2	B1	B0
STAT	R	0x0	INRESET	ERROR	—	—	PDSTAT1	PDSTAT0	RDERR	AOR
			RATE3	RATE2	RATE1	RATE0	SYSGOR	DOR	MSTAT	RDY
CTRL1	R/W	0x1	EXTCK	SYNCMODE	PD1	PD0	U/~B	FORMAT	SCYCLE	CONTSC
CTRL2	R/W	0x2	DGAIN1	DGAIN0	BUFEN	LPMODE	PGAEN	PGAG2	PGAG1	PGAG0
CTRL3	R/W	0x3	—	—	ENMSYNC	MODBITS	DATA32	PHASE	FILT1	FILT0
CTRL4	R/W	0x4	—	DIR3	DIR2	DIR1	—	DIO3	DIO2	DIO1
CTRL5	R/W	0x5	CAL1	CAL0	—	—	NOSYSG	NOSYSO	NOSCG	NOSCO
DATA	R	0x6	D[23:0]							
SOC_SPI	R/W	0x7	B[23:0]							
SGC_SPI	R/W	0x8	B[23:0]							
SCOC_SPI	R/W	0x9	B[23:0]							
SCGC_SPI	R/W	0xA	B[23:0]							
HPF	R/W	0xB	B[15:0]							
RAM	R/W	0xC	Address space only, not a physical register. Please contact factory for instructions on using internal RAM function.							
SYNC_SPI	W	0xD	Address space only, not a physical register. Please contact factory for instructions on using internal RAM function.							
SOC_ADC	R	0x15	B[23:0]							
SGC_ADC	R	0x16	B[23:0]							
SCOC_ADC	R	0x17	B[23:0]							
SCGC_ADC	R	0x18	B[23:0]							

**Status Register (Read Only)**

The 16-bit status register is a read-only register that indicates the following: power-down status, if the modulator was reset or overloaded, the data rate, overrange condition, when a measurement is in progress and when a measurement is complete.

BIT	B15	B14	B13	B12	B11	B10	B09	B08	B07	B06	B05	B04	B03	B02	B01	B00
BIT NAME	INRESET	ERROR	—	—	PDSTAT1	PDSTAT0	RDERR	AOR	RATE3	RATE2	RATE1	RATE0	SYSGOR	DOR	MSTAT	RDY
DEFAULT	0	0	1	1	1	0	0	0	1	0	0	1	0	0	0	0

BIT	DEFAULT	LABEL	FUNCTION
00	0	RDY	Ready bit. RDY = 1 when a new conversion result is available. A read of the DATA register resets RDY = 0. The function of the RDY bit is redundant and is duplicated by RDYB pin.
01	0	MSTAT	Measurement status bit. MSTAT = 1 indicates that a conversion, self-calibration, or system calibration is in progress and that the modulator is busy. When the modulator is not converting, MSTAT = 0.
02	0	DOR	Data overrange bit. DOR = 1 indicates that the conversion result has exceeded the maximum or minimum value and that the result has been clipped or limited to the maximum value. DOR = 0 when the conversion result is within the full-scale range.
03	0	SYSGOR	System gain overrange bit. SYSGOR = 1 indicates that a system gain calibration was overranged. The SGC calibration coefficient maximum value is 1.9999999.
04	1	RATE0	Data rate bits. See Table 13. The RATE bits indicate the conversion rate that corresponds to the result in the DATA register or the rate that was used for calibration coefficient calculation. <b>Note:</b> RATE bits always show the rate of previous conversion and not the rate of the conversion in progress.
05	0	RATE1	
06	0	RATE2	
07	1	RATE3	
08	0	AOR	Analog overrange bit. AOR = 1 when the modulator detects that the analog input voltage exceeds 1.3 x full-scale range.
09	0	RDERR	Data read error bit. RDERR = 1 when new result is being written to the DATA register while user is reading from the DATA register. RDERR = 0 otherwise.
10	0	PDSTAT0	00: ADC is converting 01: Device is fully powered down
11	1	PDSTAT1	10: In standby mode with modulator powered OFF but subregulator powered ON. 11: Reserved.
12	1	—	—
13	1	—	—
14	0	ERROR	Error bit. ERROR = 1 when CAL[1:0] bits are set to invalid setting of 11.
15	0	INRESET	In reset bit. INRESET = 1 when software reset is initiated till the part exits reset mode.

**Table 13. Programmable Conversion Rates**

RATE [3:0]	CONTINUOUS DATA RATE, SCYCLE = 0		
	SINC FILTER (sps)	FIR FILTER (sps)	SCYCLE = 1 SINGLE -CYCLE CONTINUOUS DATA RATE (sps)
0000	0.95	—	25
0001	1.9	—	31.25
0010	3.9	—	50
0011	7.8	—	62.5
0100	15.6	—	100
0101	31.25	—	125
0110	62.5	62.5	200
0111	125	125	250
1000	250	250	400
1001	500	500	500
1010	1000	1000	800
1011	2000	2000	1000
1100	4000	4000	1600
1101	8000	8000	2000
1110	16000	—	3200
1111	32000	—	6400

\*Continuous data rate with SCYCLE = 0, single cycle with CONTSC = 1, SCYCLE = 1. The FIR filter can only run in continuous conversion mode.

**Control Registers**

These are registers reserved for configuring the MAX11214.

**Control 1 Register (Read/Write)**

The CTRL1 register is an 8-bit read/write register. The byte written to the CTRL1 register determines the clock setting, synchronization mode, power-down or reset state, input range is unipolar or bipolar, data output is two's complement or offset binary, and conversion mode is in single cycle or continuous.

BIT	B07	B06	B05	B04	B03	B02	B01	B00
BIT NAME	EXTCK	SYNC	PD1	PD0	U/ $\bar{B}$	FORMAT	SCYCLE	CONTSC
DEFAULT	0	0	0	0	0	0	1	0

BIT	DEFAULT	LABEL	FUNCTION	
00	0	CONTSC	Continuous single-cycle bit. Set CONTSC = 1 to select continuous conversions. Set CONTSC = 0 to select a single conversion.	
01	1	SCYCLE	Single-cycle control bit. Set SCYCLE = 1 to select single-cycle mode. The MAX11214 completes one no-latency conversion and then powers down into a leakage-only state. Set SCYCLE = 0 to select continuous conversion mode.	
02	0	FORMAT	Bipolar range format bit. When reading bipolar data, set FORMAT = 0 to select two's complement and FORMAT = 1 to select offset binary. The data from unipolar range is always formatted in offset binary format.	
03	0	U/ $\bar{B}$	U/ $\bar{B}$ : Unipolar/bipolar bit. Set U/ $\bar{B}$ = 1 to select the unipolar input range (0 to $V_{REF}$ ). Set U/ $\bar{B}$ = 0 to select the bipolar input range ( $\pm V_{REF}$ ).	
04	0	PD0	00	Normal power-up state. This is the default state.
			01	Sleep Mode—Powers down the subregulator and the entire digital circuitry. Upon resumption of power to the digital the PD[1:0] reverts to the default state of '00'.
05	0	PD1	10	Standby power—Powers down the analog blocks leaving the subregulator powered up.
			11	Resets all registers to POR state leaving the subregulator powered. The PD[1:0] bits are reset to '00'. The operation of this state is identical to the RSTB pin.
06	0	SYNC	Set SYNC = 1 to select continuous synchronization mode. Set SYNC = 0 to select pulse synchronization mode.	
07	0	EXTCK	External clock bit. Set EXTCLK = 1 to select the external clock as the system clock. Set EXTCLK = 0 to select the internal oscillator as the system clock.	

**Control 2 Register (Read/Write)**

The CTRL2 register is an 8-bit read/write register. The byte written to the CTRL2 register determines the digital and analog gain settings, and whether the buffers or PGA is enabled.

BIT	B07	B06	B05	B04	B03	B02	B01	B00
BIT NAME	DGAIN1	DGAIN0	BUFEN	LPMODE	PGAEN	PGAG2	PGAG1	PGAG0
DEFAULT	0	0	0	0	0	0	0	0

BIT	DEFAULT	LABEL	FUNCTION	
00	0	PGA0	000	X1
			001	X2
			010	X4
01	0	PGA1	011	X8
			100	X16
			101	X32
02	0	PGA2	110	X64
			111	X128
03	0	PGAEN	PGA Enable Bit. Set PGAEN = 1 to enable the PGA. Set PGAEN = 0 to disable the PGA.	
04	0	LPMODE	PGA Low Power. Set LPMODE = 1 for lower power. Set LPMODE = 0 for standard power.	
05	0	BUFEN	Analog input buffer enable bit. Set BUFEN = 1 to enable the analog input buffers. Set BUFEN = 0 to disable the analog input buffers.	
06	0	DGAIN0	00	x1
			01	x2
07	0	DGAIN1	10	x4
			11	x8



**Control 3 Register (Read/Write)**

The CTRL3 register is an 8-bit read/write register. The byte written to the CTRL3 register determines the FIR filter phase and selected filters.

BIT	B07	B06	B05	B04	B03	B02	B01	B00
<b>BIT NAME</b>	—	—	ENMSYNC	MODBITS	DATA32	PHASE	FILT1	FILT0
<b>DEFAULT</b>	0	1	1	0	0	0	0	1

BIT	DEFAULT	LABEL	FUNCTION
<b>00</b>	1	FILT0	Filter control bits. When SCYCLE = 1 (CTRL1 register), the SINC filter is the only filter option. 0x SINC 10 FIR 11 FIR + IIR
<b>01</b>	0	FILT1	
<b>02</b>	0	PHASE	
<b>03</b>	0	DATA32	32-bit data mode bit. Set DATA32 = 1 to read 32 bits of data at DOUT. Set DATA32 = 0 for 24-bit data reads at DOUT. See the <i>Data Register</i> section.
<b>04</b>	0	MODBITS	Modulator output mode enable bit. Set MODBITS = 1 to enable the modulator output on DOUT and GPIO1. Set MODBITS = 0 for standard data output mode on DOUT.
<b>05</b>	1	ENMSYNC	Modulator synchronization pulse enable bit. Set ENMSYNC = 1 to enable the synchronization pulse for modulator output mode. Set ENMSYNC = 0 to disable the synchronization pulse for modulator output mode.
<b>06</b>	1	—	Reserved bit
<b>07</b>	0	—	Reserved bit

**Control 4 Register (Read/Write)**

The CTRL4 register is an 8-bit read/write register. The byte written to the CTRL4 register determines whether the GPIOs are inputs or outputs, and whether they are enabled.

BIT	B07	B06	B05	B04	B03	B02	B01	B00
<b>BIT NAME</b>	—	DIR3	DIR2	DIR1	—	DIO3	DIO2	DIO1
<b>DEFAULT</b>	0	0	0	0	1	1	1	1

BIT	DEFAULT	LABEL	FUNCTION
<b>00</b>	1	DIO1	GPIO bit values. When GPIO is configured as an output, set the DIO bits = 0 to set the associated GPIO output as a 0. When GPIO are configured as inputs, these bits indicate the pin status.
<b>01</b>	1	DIO2	
<b>02</b>	1	DIO3	
<b>03</b>	1	—	GPIO direction bits. Set the DIR bits = 0 to configure the associated GPIO as an input. The value returned by a read of the DIO bit is the value being driven on the pin. Set the DIR bits = 1 to configure the associated GPIO as an output. The GPIO is driven to the logic value of the associated DIO bit.
<b>04</b>	0	DIR1	
<b>05</b>	0	DIR2	
<b>06</b>	0	DIR3	
<b>07</b>	0	—	

**Control 5 Register (Read/Write)**

The CTRL5 register is an 8-bit read/write register. The byte written to the CTRL5 register determines the MAX11214's reset, data overflow, and calibration modes.

BIT	B07	B06	B05	B04	B03	B02	B01	B00
BIT NAME	CAL1	CAL0	—	—	NOSYSG	NOSYSO	NOSCG	NOSCO
DEFAULT	0	0	0	0	1	1	0	0

BIT	DEFAULT	LABEL	FUNCTION
00	0	NOSCO	No self-calibration offset bit. Set NOSCO = 1 to disable the use of the self-calibration offset value when computing the final offset and gain-corrected data value. Set NOSCO = 0 to enable the use of the self-calibration offset value when computing the final offset and gain-corrected data value.
01	0	NOSCG	No self-calibration gain bit. Set NOSCG = 1 to disable the use of the self-calibration gain value when computing the final offset and gain-corrected data value. Set NOSCG = 0 to enable the use of the self-calibration gain value when computing the final offset and gain-corrected data value.
02	1	NOSYSO	No system offset bit. Set NOSYSO = 1 to disable the use of the system offset value when computing the final offset and gain-corrected data value. Set NOSYSO = 0 to enable the use of the system offset value when computing the final offset-corrected data value.
03	1	NOSYSG	No system gain bit. Set NOSYSG = 1 to disable the use of the system gain value when computing the final offset and gain-corrected data value. Set NOSYSG = 0 to enable the use of the system gain value when computing the final gain-corrected data value.
04	0	—	Reserved
05	0	—	Reserved
06	0	CAL0	00 Perform Self Calibration 01 Perform System-Level Offset Calibration
07	0	CAL1	10 Perform System-Level Full-Scale Calibration 11 Reserved

**Data Register (Read Only)**

The data register is a 32-bit or 24-bit read-only register. Any attempt to write data to the data register has no effect. The data from this register is clocked out MSB first. The data register holds the conversion result. The result is stored in either two's complement or offset binary format, depending on the FORMAT bit in CTRL1 register.

The data format in unipolar mode is always offset binary. In bipolar mode, set the FORMAT bit = 1 for offset binary or FORMAT = 0 for two's complement. Any input exceeding the available input range is limited to the minimum or maximum data value. Attempts to read this register while data is being updated (4 system clocks before RDYB asserts low) will result in invalid data being read, see Figure 13. Note that the STATUS register RDERR bit is set when this condition is detected.

BIT	B31	B30	B29	B28	B27	B26	B25	B24	B23	B22	B21	B20	B19	B18	B17	B16	B15	B14	B13	B12	B11	B10	B09	B08	B07	B06	B05	B04	B03	B02	B01	B00
DEFAULT	0	0	0	0	0	0	0	0	0	0	0	0	0	0	0	0	0	0	0	0	0	0	0	0	0	0	0	0	0	0	0	

**Table 14. ADC Output Code Data Format**

CODE TRANSITION	ANALOG INPUT (AINP - AINN) (V)	DIGITAL OUTPUT CODE (Hex)			
		OFFSET BINARY		TWO's COMPLEMENT	
		32-BIT	24-BIT	32-BIT	24-BIT
$\geq$ FS	$\geq V_{REF}$	FFFFFFFF	FFFFFF	7FFFFFFF	7FFFFF
FS - 1 LSB	$V_{REF} \times (1 - (1/2^N - 1))$	FFFFFFFE	FFFFFE	7FFFFFFE	7FFFFE
Midscale + 1 LSB	$V_{REF}/2^N - 1$	8000001	80001	0000001	00001
Midscale	$V_{REF}/2^N$	8000000	80000	0000000	00000
Midscale - 1 LSB	$-V_{REF}/2^N - 1$	7FFFFFFF	7FFFFF	FFFFFFF	FFFFF
ZS + 1 LSB	$-V_{REF} \times (1 - (1/2^N - 1))$	0000001	00001	8000001	80001
$\leq$ ZS	$\leq -V_{REF}$	0000000	00000	8000000	80000

$N$  = number of data bits, 32 or 24.

$V_{REF} = V_{REFP} - V_{REFN}$ .

## Calibration

Two types of calibration are available: self-calibration and system calibration. Self-calibration is used to reduce the MAX11214 gain and offset errors during changing operating conditions such as supply voltages, ambient temperature, and time. System calibration is used to reduce the gain and offset of the entire signal path. This enables calibration of board level components and the integrated PGA. System calibration requires the MAX11214 inputs to be reconfigured for zero scale and full scale during calibration. See [Figure 18](#) for details of the calibration signal flow.

The on-chip calibration registers are enabled or disabled by programming the NOSYSG, NOSYSO, NOSCG, and NOSCO bits in the CTRL5 register. See [Table 12](#).

### Self-Calibration

The self-calibration is an internal operation and does not disturb the analog inputs. Self-calibration is accomplished in two independent phases, offset and gain. The first phase disconnects the inputs to the modulator and shorts them together internally to develop a zero-scale signal. A conversion is then completed and the results are post-processed to generate an offset coefficient which cancels all internally generated offsets. The second phase connects the inputs to the reference to develop a full-scale signal. A conversion is then completed and the results are post-processed to generate a full-scale coefficient, which scales the converters full-scale analog range to the full-scale digital range.

The entire self-calibration sequence requires two independent conversions, one for offset and one for full scale.

The conversion rate is 50sps which provides the lowest noise and most accurate calibrations. The self-calibration operation excludes the PGA. A system-level calibration is available in order to calibrate the PGA signal path.

The calibration operations are controlled with the CAL bit in the command byte. Request a self-calibration by setting the CAL bit to 1, with the CTRL5:CAL[1:0] = 00. A self-calibration requires 200ms to complete, and both the SCOC and SCGC registers contain the values that correct the chip output for zero scale and full scale.

### System Calibration

This mode is used when board level components and the integrated PGA calibration is desired. A system calibration requires the user to configure the input to the proper level for the calibration operation. The offset and full-scale system calibrations are performed using separate command bytes by configuring the CTRL5:CAL [1:0] bits. The system offset and system full scale require setting these CAL bits appropriately before issuing the calibration command byte.

Request a system zero-scale calibration by setting the CAL bit to 1 and the CTRL5:CAL[1:0] bit = 01 and connect a system zero-level signal to the input pins. The system zero calibration requires 100ms to complete, and the SOC register contains values that correct the chip zero scale.

Request a system full-scale calibration by setting the CAL bit to 1 and the CTRL5:CAL[1:0] = 10 and connect a system full-scale signal level to the input pins. The system full-scale calibration requires 100ms to complete, and the SGC register contains values that correct for the chip full-scale value.

A third level of calibration allows a write to the internal calibration registers through the SPI interface to achieve any digital offset or scaling with the following restrictions. The range of digital offset correction is  $\pm V_{REF}/4$ . The resolution of offset correction is 0.5 LSB. The range of digital gain correction is from 0.75 to 2. The resolution of gain is less than 1ppm.

#### **SPI System Offset Calibration Register (SOC\_SPI)**

The system offset calibration register is a 24-bit read/write register. The data written/read to/from this register is clocked in/out MSB first. The format is always in two's complement. This register temporarily holds the system offset calibration value from the user. Once a conversion command is requested, this value gets copied into the SOC\_ADC register. The value written to this register remains until it is overwritten. This value gets invalidated for calibration after a system-calibration operation is requested. Any attempt to write to this register during an active calibration operation will be ignored.

#### **ADC System Offset Calibration Register (SOC\_ADC)**

This is 24-bit read only register. There are two ways this register value is updated. One way is if a system offset calibration operation is requested. Another way is if a user writes a value to SOC\_SPI register, the value will then get copied into SOC\_ADC from SOC\_SPI.

The system offset calibration value is subtracted from each conversion result if NOSYSO = 0 in the CTRL5 register. The system offset calibration value is subtracted from the conversion result after self-calibration, but before system gain correction. It is also applied prior to the 1x or 2x scale factor associated with bipolar and unipolar modes. Attempts to read this register while data is being updated (4 system clocks before RDYB asserts low) will result in invalid data being read, see Figure 13. Note that the STATUS register RDERR bit is set when this condition is detected.

#### **SPI System Gain Calibration Register (SGC\_SPI)**

The system gain calibration register is a 24-bit read/write register. The data written/read to/from this register is clocked in/out MSB first. The format is unsigned binary. This register temporarily holds the system gain calibration value from the user. Once a conversion command is requested, this value gets copied into SGC\_ADC register. The value written to this register remains until it is overwritten. This value gets invalidated for calibration after a system-calibration operation is requested. Any attempt to write to this register during an active calibration operation will be ignored.

#### **ADC System Gain Calibration Register (SGC\_ADC)**

This is 24-bit read only register. There are two ways this register value is updated. One way is if a system gain calibration operation is requested. Another way is if a user writes a value to SGC\_SPI register, the value will then get copied into SGC\_ADC from SGC\_SPI.

The system gain calibration value is used to scale the offset-corrected conversion result if NOSYSG = 0 in the CTRL5 register. The system gain calibration value scales the gain corrected result by up to 2x or can correct a gain error of approximately 50%. The amount of positive gain error that can be corrected is determined by modulator overload characteristics which may be as much as +125%. The gain will be corrected to within 1ppm. Attempts to read this register while data is being updated (4 system clocks before RDYB asserts low) will result in invalid data being read, see Figure 13. Note that the STATUS register RDERR bit is set when this condition is detected.

**SPI Self-Cal Offset Calibration Register (SCOC\_SPI)**

The Self-Cal Offset register is a 24-bit read/write register. The data written/read to/from this register is clocked in/out MSB first. The format is always in two's complement format. This register temporarily holds the self-cal offset calibration value from the user. Once a conversion command is requested, this value gets copied into SCOC\_ADC register. The value written to this register remains until it is overwritten. This value gets invalidated for calibration after a system-calibration operation is requested. Any attempt to write to this register during an active calibration operation will be ignored.

**ADC Self-Cal Offset Calibration Register (SCOC\_ADC)**

This is a 24-bit read-only register. There are two ways this register value is updated. One way is if a self-cal operation is requested. Another way is if a user writes a value to SCOC\_SPI register, the value will then get copied into SCOC\_ADC from SCOC\_SPI.

The self-cal offset value is subtracted from each conversion result if NOSCO = 0 in the CTRL5 register. The self-cal offset value is subtracted from the conversion result before the self-calibration gain correction and before the system offset and gain correction. It is also applied prior to the 2x scale factor associated with unipolar mode. Attempts to read this register while data is being updated (4 system clocks before RDYB asserts low) will result in invalid data being read, see Figure 13. Note that the STATUS register RDERR bit is set when this condition is detected.

**SPI Self-Cal Gain Calibration Register (SCGC\_SPI)**

The self-cal gain calibration register is a 24-bit read/write register. The data written/read to/from this register is clocked in/out MSB first. The format is always unsigned binary. This register temporarily holds the self-cal gain calibration value from the user. Once a conversion command is requested, this value gets copied into SCGC\_ADC register. The value written to this register remains until it is overwritten. This value gets invalidated for calibration after a system-calibration operation is requested. Any attempt to write to this register during an active calibration operation will be ignored.

**ADC Self-Cal Gain Calibration Register (SCGC\_ADC)**

This is a 24-bit read only register. There are two ways this register value is updated. One way is if a self-cal operation is requested. Another way is if a user writes a value to SCGC\_SPI register, the value will then get copied into SCGC\_ADC from SCGC\_SPI.

The self-cal gain calibration value is used to scale the self-cal offset corrected conversion result before the system offset and gain calibration values have been applied – provided NOSCG = 0 in the CTRL5 register. The self-cal gain calibration value scales the self-cal offset corrected conversion result by up to 2x or can correct a gain error of approximately 50%. The gain will be corrected to within 1ppm. Attempts to read this register while data is being updated (4 system clocks before RDYB asserts low) will result in invalid data being read, see Figure 13. Note that the STATUS register RDERR bit is set when this condition is detected.

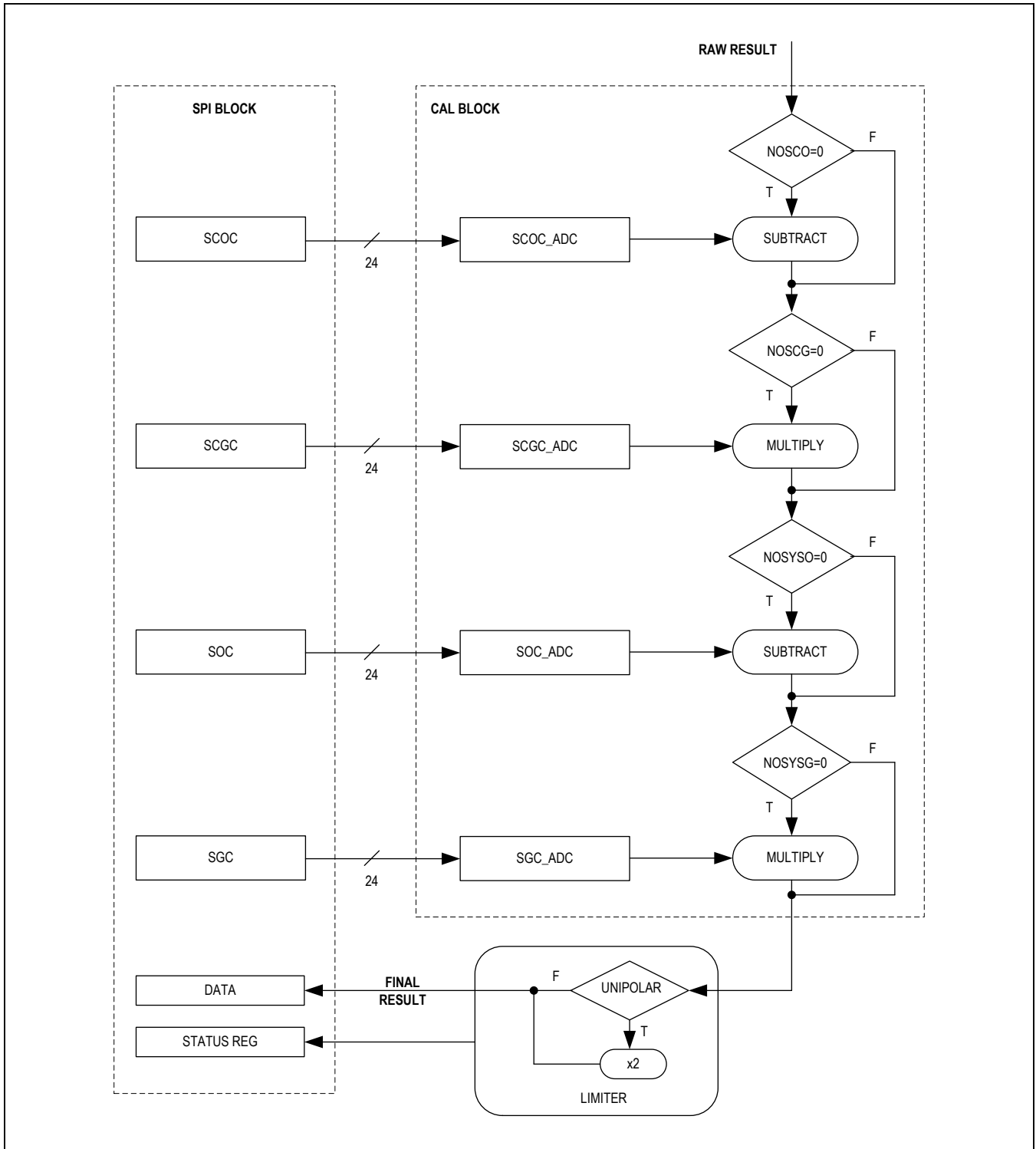

Figure 18. Calibration Flow Diagram

**Highpass Filter Configuration Register (Read/Write)**

The highpass filter configuration register programs the corner frequency of the IIR highpass filter. Any attempt to write to this register during an active conversion operation will be ignored. This register should be updated during standby or sleep modes only.

BIT	B15	B14	B13	B12	B11	B10	B09	B08	B07	B06	B05	B04	B03	B02	B01	B00
DEFAULT	0	0	0	0	0	0	1	1	0	0	1	1	0	0	1	0

**GPIOs**

The MAX11214 provides three general-purpose input/output ports that are programmable through the CTRL4 register. Set the DIR bits in the CTRL4 register to select the pins to be configured as inputs or outputs. All pins are inputs by default. When programmed as output, set the DIO bits in the CTRL4 register to set pin state to 0 or 1.

**Conversion Synchronization Using SYNC Pin or SYNC\_SPI Function**

The SYNC pin can be used to synchronize the data conversions to external events. This can be done by either pulling the SYNC pin high or addressing the SYNC\_SPI register in a SPI command byte. There are two methods available in the device to synchronize conversion results using external signals on the SYNC pin: continuous mode or pulse mode.

**Continuous Mode**

Continuous synchronization mode is used to detect if the current conversions are synchronized to a continuous synchronization pulse with a period greater than the data rate. This synchronization mode compares the number of device master clocks between the RDYB assertion to the rising edge of the SYNC pin. The relative edges should stay aligned within 1 master clock period of the initial SYNC pulse and remain within integer multiples of the data rate. If the rising edge of the SYNC pin occurs after an integer multiple of the data rate and is greater than plus or minus 1 master clock from the initial SYNC rising edge then the chip resets the conversion in progress, flushes the digital filter contents and starts a new conversion. The conversion reset process incurs the full digital filter latency before valid results are available.

See [Figure 19](#) for timing waveform relationships between the chip master clock and the SYNC pin. Due to startup delays, any SYNC pin assertions before the first RDYB assertion are ignored. The first SYNC pin assertion after a RDYB assertion establishes the relationship between the SYNC pin and the conversion ready, timed in master clock units. This relationship is defined as n, which constitutes the number of clocks that occur between the assertion of RDYB and the rising edge of the SYNC pin.

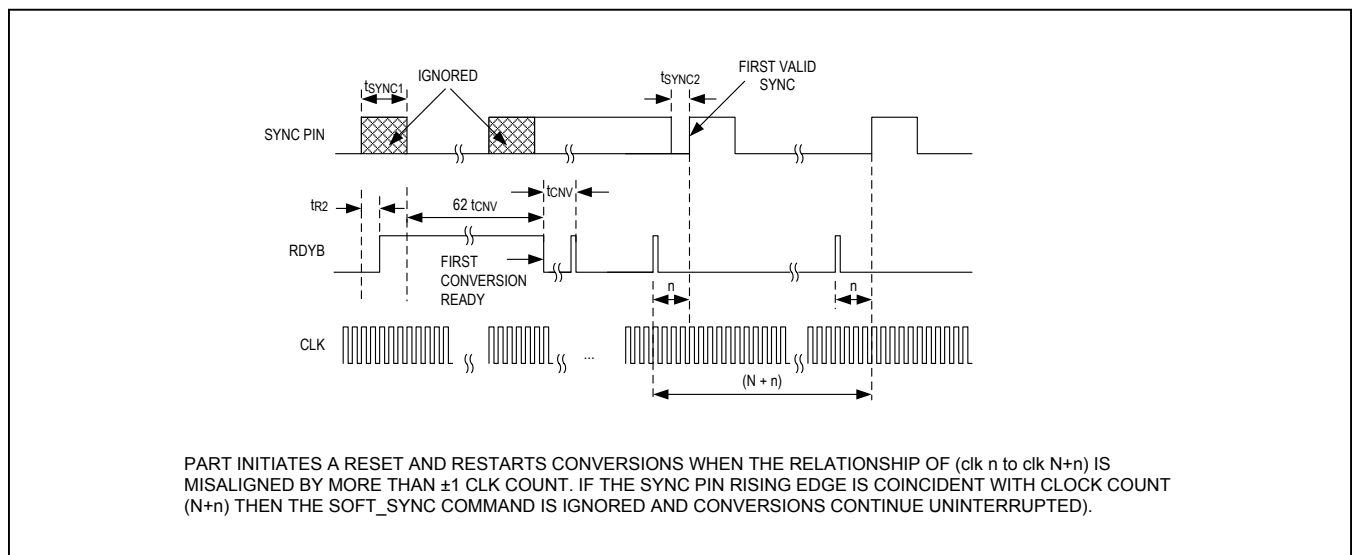

Figure 19. Synchronization Using Continuous Sync Mode Showing Relationship Between SYNC Pin and CLK Pin

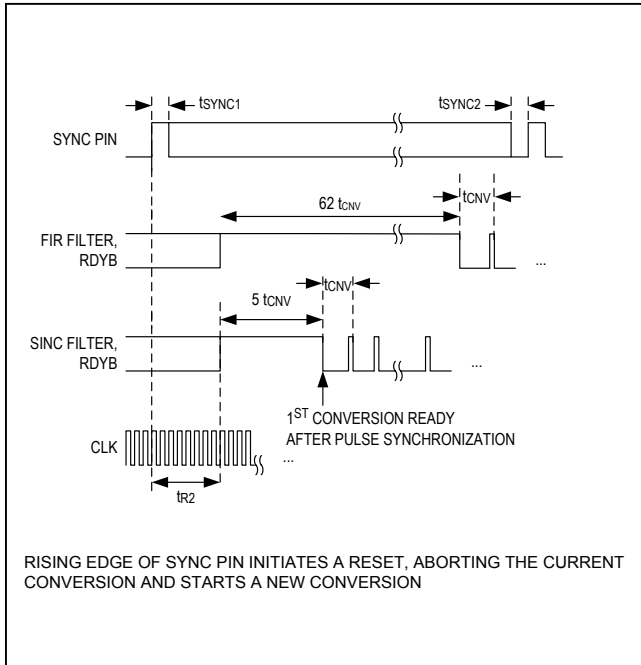

Figure 20. Synchronization Using Pulse Sync Mode Showing Relationship Between SYNC, RDYB, and CLK Pins

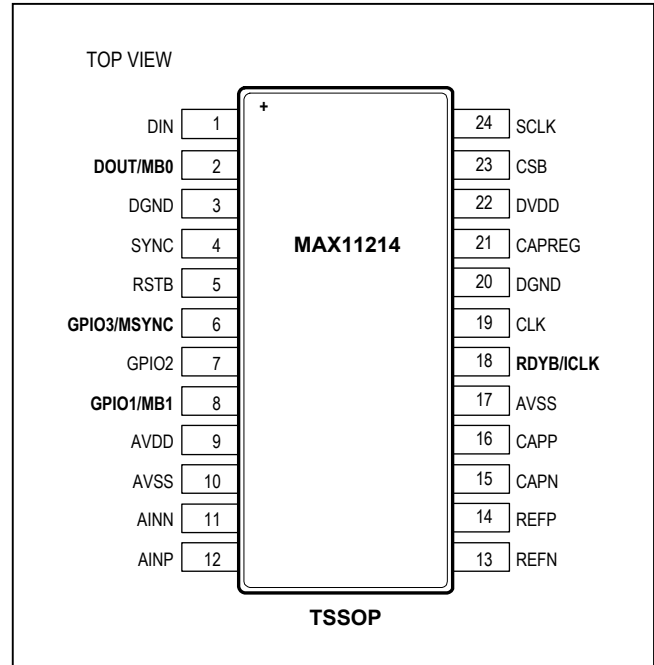

Figure 21. Pin Configuration with MODBITS

**Pulse Mode**

Pulse or single event synchronization mode starts a new conversion upon the rising edge of the SYNC pin. When the SYNC pin is asserted the chip begins conversions using the speed settings from the previous convert command, if no previous convert command was issued prior to the SYNC pin asserting then the default conversion speed of 1ksps is used. Note that convert start and SYNC pin rising edge cannot be applied at the same time. Any activity on the SYNC pin is ignored until after the first RDYB assertion following a convert start. This is required due to convert start overhead which delays the first conversion result by 32 master clocks.

**Modulator MODBITS Mode**

The MODBITS mode bypasses the MAX11214’s internal filters and outputs the real-time 5-bit modulator data to the DOUT and GPIO pins.

MODBITS mode is controlled by the MODBITS and ENMSYNC bits in the CTRL3 register.

**Initializing MODBITS Mode**

Set the CTRL3: MODBITS to 1 to enter the MODBITS mode and read the real-time modulator output data. After setting the control bits, a conversion command must be issued. This starts the modulator without running the rest of the digital logic needed for a full conversion. Setting CTRL3: ENMSYNC = 1 enables the modulator SYNC pulses to shift out onto GPIO3/MSYNC. The modulator mode can be run even if this bit is disabled. If ENMSYNC = 0, the SYNC pulses will not be shifted out on GPIO3/MSYNC.

**Exiting MODBITS Mode**

To go back to normal conversion mode, set MODBITS = 0. If MODBITS = 0, ENMSYNC is a don’t care. After setting MODBITS = 0, issue a conversion command to activate the MAX11214 in normal data read mode.

**MODBITS Mode Pin Configurations**

The DOUT/MB0, GPIO3/MSYNC, and GPIO1/MB1 pins offer dual functionality, depending on whether MODBITS real-time modulator data mode or normal data output mode is selected.



**DOUT/MB0**

In MODBIT mode, the DOUT/MB0 outputs the real-time modulator data (MB0). When the ENMSYNC bit = 0, DOUT/MB0 outputs the first MSYNC pulse and shifts out the even bits of the modulator data (bit 4, bit 2, and bit 0). The first SYNC pulse (indicating valid modulator data) will be shifted out on the positive clock edge (referred to as clock edge 1) for initial synchronization. For all other data cycles, the clock edge 1 will output 0 on this pin (as well as 0 on GPIO1/MB1) indicating the end of a current data stream. On clock edge 2, 3, and 4 DOUT/MB0 shifts out the even data bits as described earlier.

**GPIO3/MSYNC**

When ENMSYNC = 1 in the MODBIT mode, GPIO3/MSYNC functions as the modulator sync (MSYNC) output. The SYNC pulse from the modulator is shifted out on the positive clock edge. When the sync signal shifts out on the GPIO3/MSYNC pin, the data is “00” on both the DOUT/MB0 and GPIO1/MB1 pins and marks the starting point of the next modulator data.

**GPIO1/MB1**

In MODBIT mode, the GPIO1/MB1 functions as a real-time modulator data output. On clock edge 1, GPIO1/MB1 always outputs 0 (irrespective of the state of ENMSYNC). On clock edge 2 and 3, this pin will shift out the odd bits of the modulator data (bit 3 and bit 1). GPIO1/MB1 is 0 on clock edge 3 as well.

**RDYB/ICLK**

When the MODBITS bit = 1, the internal system clock (running at 4.096MHz) is output on RDYB/ICLK. This enables aligning the data to the clock edge.

The description of the data shift described above is detailed in the [Figure 22](#). It shows both cases with ENMSYNC = 0 or 1 and the difference in the behavior of GPIO3/MSYNC and DOUT/MB0. RDYB and GPIO1/MB1 are unaffected by the ENMSYNC bit.

**Table 15. MODBITS Mode Pins**

NORMAL FUNCTION	MODBITS FUNCTION	DESCRIPTION
DOUT	MB0	ENMSYNC=0, output MSYNC first followed by even bits of modulator data. ENMSYNC=1, output even bits of modulator data only
GPIO1	MB1	Odd bits (bits 1 and 3) of modulator data
GPIO3	MSYNC	Shifts SYNC pulses from the modulator
RDYB	ICLK	Internal clock

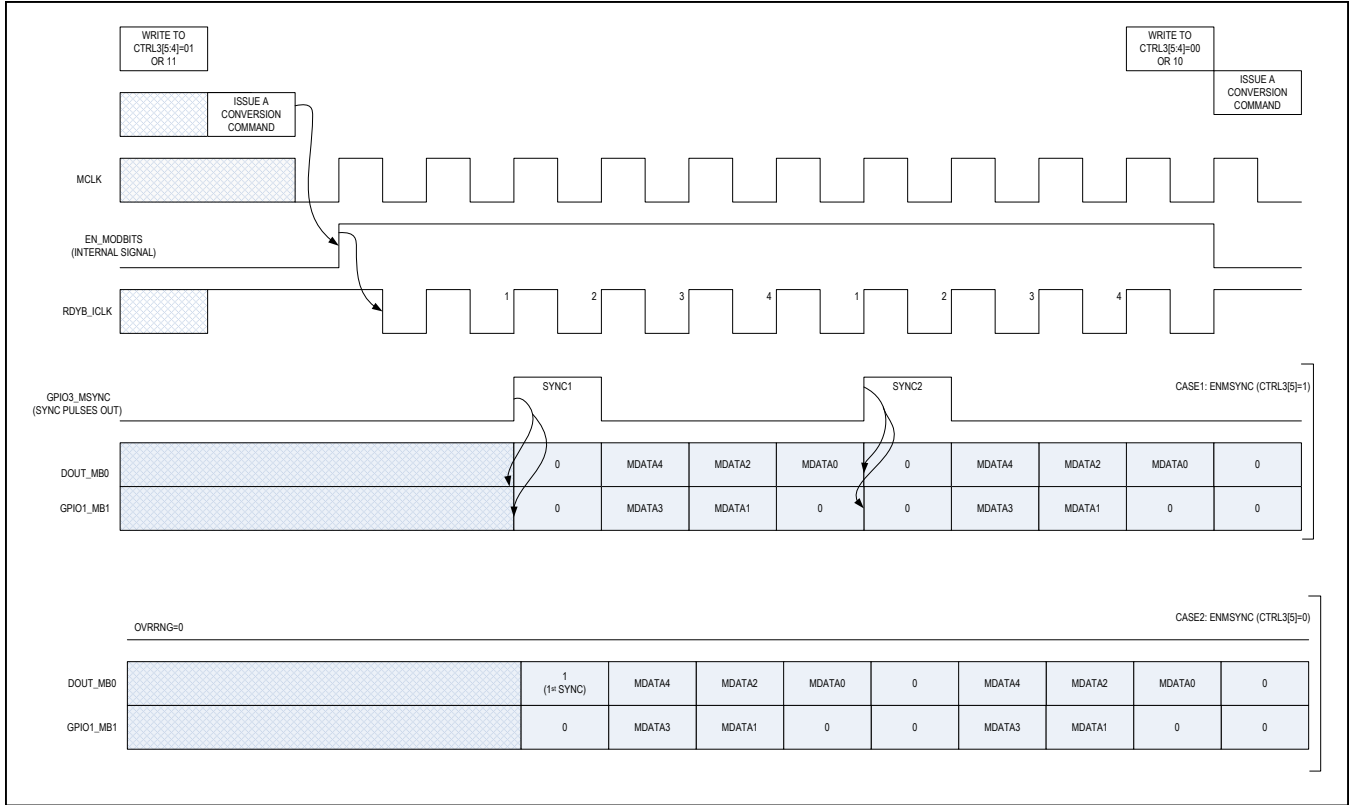
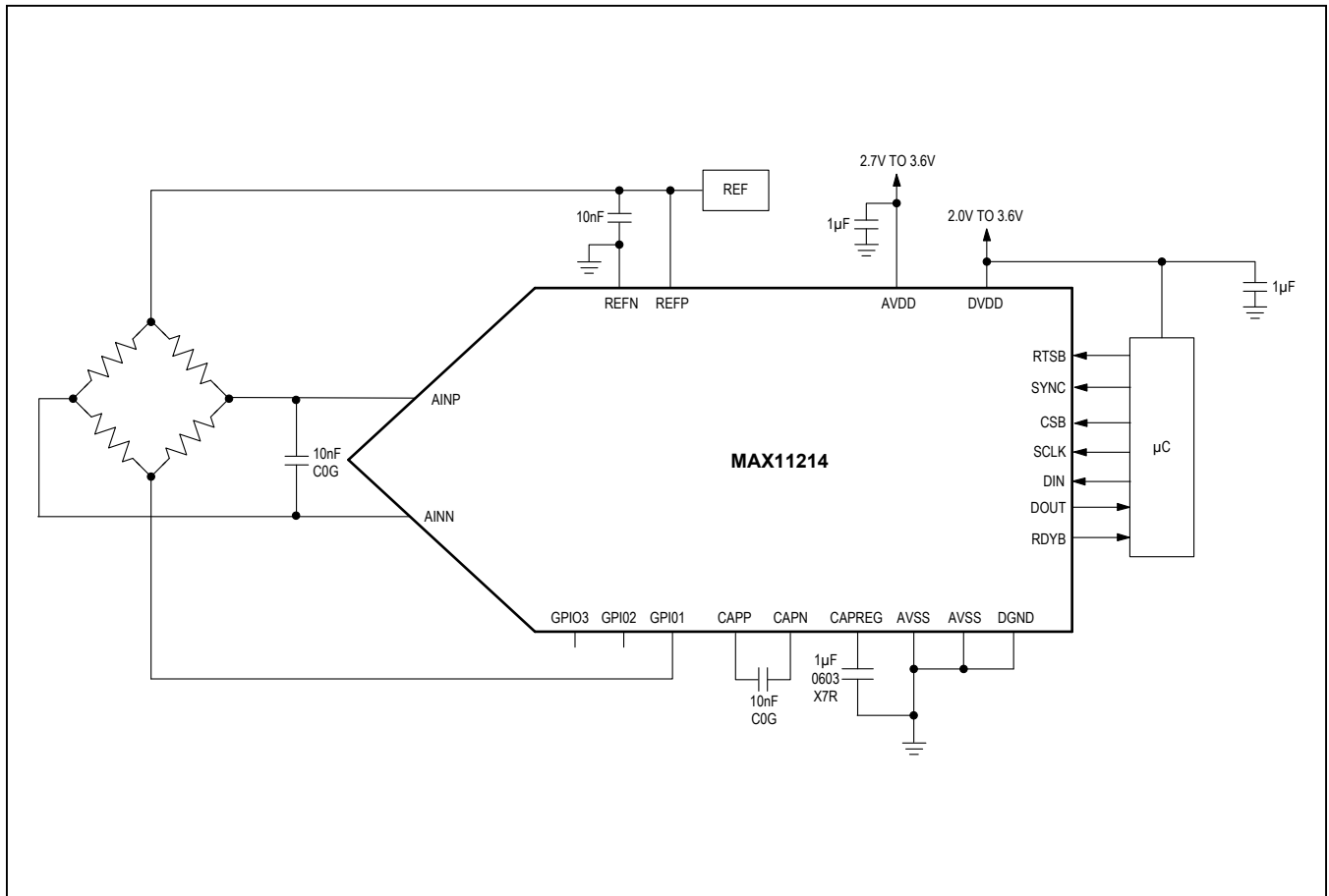

Figure 22. Timing Diagram for MODBITS Mode

Typical Application Circuit



MAX11214

24-Bit, 5mW, 140dB SNR, 32ksps Delta-Sigma ADC  
with Integrated PGA

### Ordering Information

PART	TEMP RANGE	PIN-PACKAGE
MAX11214EUG+	-40°C to +85°C	24 TSSOP
MAX11214EUG+T	-40°C to +85°C	24 TSSOP

+Denotes a lead(Pb)-free/RoHS-compliant package.  
T = Tape and reel.

### Chip Information

PROCESS: BiCMOS

### Package Information

For the latest package outline information and land patterns (footprints), go to [www.maximintegrated.com/packages](http://www.maximintegrated.com/packages). Note that a "+", "#", or "-" in the package code indicates RoHS status only. Package drawings may show a different suffix character, but the drawing pertains to the package regardless of RoHS status.

PACKAGE TYPE	PACKAGE CODE	OUTLINE NO.	LAND PATTERN NO.
24 TSSOP	U24+2	<a href="#">21-0066</a>	<a href="#">90-0118</a>

## Revision History

REVISION NUMBER	REVISION DATE	DESCRIPTION	PAGES CHANGED
0	3/15	Initial release	—

For pricing, delivery, and ordering information, please contact Maxim Direct at 1-888-629-4642, or visit Maxim Integrated's website at [www.maximintegrated.com](http://www.maximintegrated.com).

*Maxim Integrated cannot assume responsibility for use of any circuitry other than circuitry entirely embodied in a Maxim Integrated product. No circuit patent licenses are implied. Maxim Integrated reserves the right to change the circuitry and specifications without notice at any time. The parametric values (min and max limits) shown in the Electrical Characteristics table are guaranteed. Other parametric values quoted in this data sheet are provided for guidance.*



Компания «ЭлектроПласт» предлагает заключение долгосрочных отношений при поставках импортных электронных компонентов на взаимовыгодных условиях!

Наши преимущества:

- Оперативные поставки широкого спектра электронных компонентов отечественного и импортного производства напрямую от производителей и с крупнейших мировых складов;
- Поставка более 17-ти миллионов наименований электронных компонентов;
- Поставка сложных, дефицитных, либо снятых с производства позиций;
- Оперативные сроки поставки под заказ (от 5 рабочих дней);
- Экспресс доставка в любую точку России;
- Техническая поддержка проекта, помощь в подборе аналогов, поставка прототипов;
- Система менеджмента качества сертифицирована по Международному стандарту ISO 9001;
- Лицензия ФСБ на осуществление работ с использованием сведений, составляющих государственную тайну;
- Поставка специализированных компонентов (Xilinx, Altera, Analog Devices, Intersil, Interpoint, Microsemi, Aeroflex, Peregrine, Syfer, Eurofarad, Texas Instrument, Miteq, Cobham, E2V, MA-COM, Hittite, Mini-Circuits, General Dynamics и др.);

Помимо этого, одним из направлений компании «ЭлектроПласт» является направление «Источники питания». Мы предлагаем Вам помощь Конструкторского отдела:

- Подбор оптимального решения, техническое обоснование при выборе компонента;
- Подбор аналогов;
- Консультации по применению компонента;
- Поставка образцов и прототипов;
- Техническая поддержка проекта;
- Защита от снятия компонента с производства.



#### Как с нами связаться

**Телефон:** 8 (812) 309 58 32 (многоканальный)

**Факс:** 8 (812) 320-02-42

**Электронная почта:** [org@eplast1.ru](mailto:org@eplast1.ru)

**Адрес:** 198099, г. Санкт-Петербург, ул. Калинина, дом 2, корпус 4, литера А.