

DIO1280

Over-Voltage Protection Load Switch

Features

- Surge Protection
IEC 61000-4-5: >100V
- Over-Voltage Protection (OVP)
- Over-Temperature Protection (OTP)
- ESD Protection
IEC 61000-4-2 Air Discharge: > 15kV
IEC 61000-4-2 Contact Discharge: > 8kV
- +/- 100V EOS Protection
- Negative Voltage Protection(-30V)

Applications

- Mobile Handsets and Tablets
- Portable Media Players
- MP3 Players

Descriptions

The DIO1280 features a low- R_{ON} internal FET and an operating range of 2.5 V_{DC} to 25 V_{DC} (absolute maximum of 30 V_{DC}). An internal clamp is capable of shunting surge voltages >100V, protecting downstream components and enhancing system robustness. The DIO1280 features over-voltage protection that powers down the internal FET if the input voltage exceeds the OVP threshold. The OVP threshold is adjustable with optional external resistors. Over-temperature protection also powers down the device at 130°C (typical). Exceptionally low off-state current (<1 μ A maximum) facilitates compliance with standby power requirements.

The DIO1280 is available in a EP-SOIC8 package and a fully “green” compliant 1.3mm x 1.8mm Wafer-Level Chip-Scale Package (WLCSP) with backside laminate.

Function Block Diagram

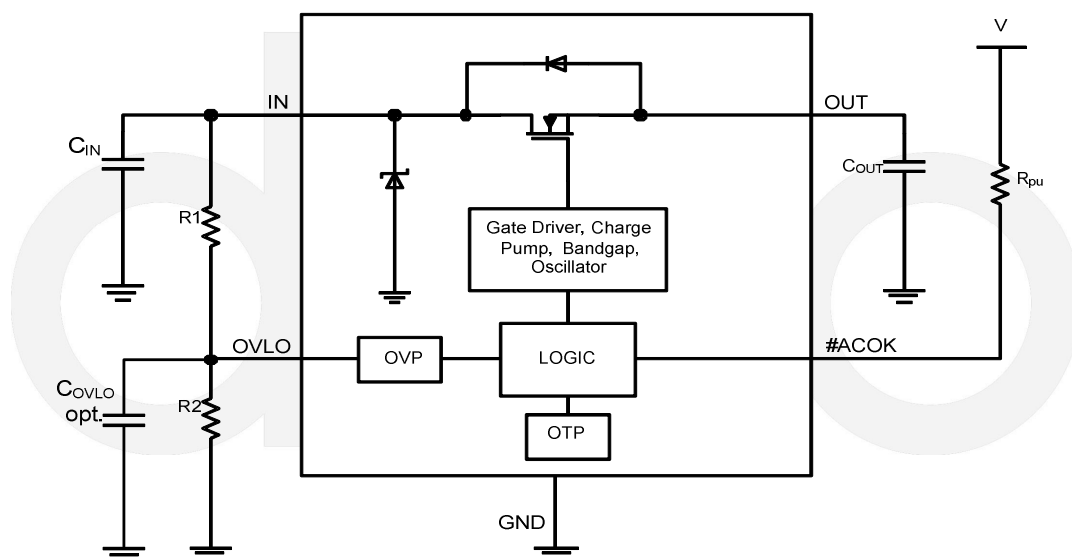
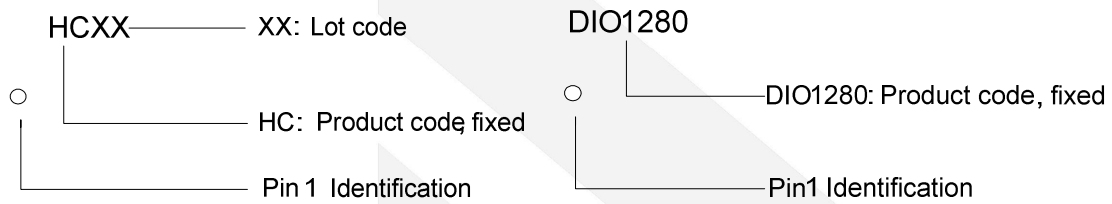

Figure 1 Functional Block Diagram

Ordering Information

Order Part Number	Top Marking		T _A	Package	
DIO1280WL12	HCXX	Green	-40 to +85°C	WLCSP-12 0.4mm pitch	Tape & Reel, 3000
DIO1280XS8	DIO1280	Green	-40 to +85°C	EP-SOIC8	Tape & Reel, 2500

Marking Definition



Pin Configuration

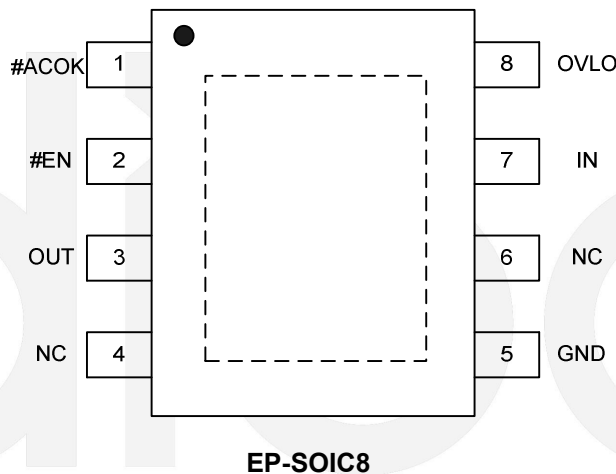
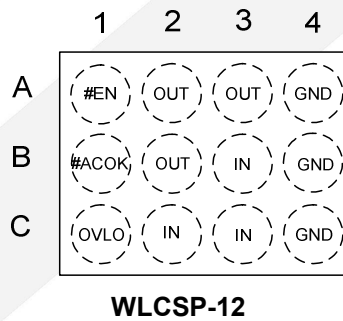

Figure 2 Pin Assignment (Top View)



DIO1280

Over-Voltage Protection Load Switch

Pin Definitions

Name	Bump	Type	Description	
IN	B3,C2,C3	Input/Supply	Switch Input and Device Supply	
OUT	A2,A3,B2	Output	Switch Output to Load	
#ACOK	B1	Output	Power Good	1 $V_{IN} < V_{IN_min}$ or $V_{IN} \geq V_{OVLO}$
				0 Voltage Stable
#EN	A1	Input	Device Enable, Low is enable.	
OVLO	C1	Input	Over-Voltage Lockout Adjustment Pin	
GND	A4,B4,C4	Supply	Device Ground	
NC		NC	No Connect	

Absolute Maximum Ratings

Stresses beyond those listed under “Absolute Maximum Rating” may cause permanent damage to the device. These are stress ratings only and functional operation of the device at these or any other condition beyond those indicated in the operational sections of the specifications is not implied. Exposure to absolute maxim rating conditions for extended periods may affect device reliability.

Symbol	Parameter	Rating	Unit	
V_{IN}	V_{IN} to GND	-30 to +30	V	
V_{OUT}	V_{OUT} to GND	-0.3 to $V_{IN}+0.3$	V	
V_{OVLO}	OVLO to GND	-0.3 to 30	V	
$V_{\#EN_ACOK}$	Maximum DC Voltage Allowed on #EN or ACOK Pin	6	V	
I_{IN}	Switch I/O Current (Continuous)	4.5	A	
t_{PD}	Total Power Dissipation at $T_A=25^{\circ}C$	1.48	W	
T_{STG}	Storage Temperature Range	-65 to 150	$^{\circ}C$	
T_J	Maximum Junction Temperature	150	$^{\circ}C$	
T_L	Lead Temperature (Soldering, 10 Seconds)	260	$^{\circ}C$	
θ_{JA}	Thermal Resistance, Junction-to-Ambient	84.1	$^{\circ}C/W$	
ESD	IEC 61000-4-2 System ESD	Air Gap	15.0	kV
		Contact	8.0	
Surge	IEC 61000-4-5, Surge Protection	V_{IN}	100	V



DIO1280

Over-Voltage Protection Load Switch

Recommended Operating Conditions

The Recommended Operating Conditions table defines the conditions for actual device operation. Recommended Operating conditions are specified to ensure optimal performance to the datasheet specifications. DIOO does not Recommend exceeding them or designing to Absolute Maximum Ratings.

Symbol	Parameter	Min	Typ.	Max	Unit
V_{IN}	Supply Voltage	2.5		25	V
T_A	Operating Temperature	-40		+105	°C
I_{OUT}	Output Current			3	A

Electrical Characteristics

$T_A = -40^{\circ}\text{C}$ to 85°C , unless otherwise specified. Typical values are $V_{IN}=5.0\text{V}$, $I_{IN}\leq 3\text{A}$, $C_{IN}=0.1\mu\text{F}$ and $T_A=25^{\circ}\text{C}$.

Symbol	Parameter	Test Conditions	Min	Typ	Max	Unit
V_{IN_CLAMP}	Input Clamping Voltage	$I_{IN}=10\text{mA}$		35		V
I_Q	Input Quiescent Current	$V_{IN}=5\text{V}$, #EN=0V		80	110	μA
I_{IN_Q}	OVLO Supply Current	$V_{OVLO}=3\text{V}$, $V_{IN}=5\text{V}$. $V_{OUT}=0\text{V}$		70	96	μA
V_{UVLO}	Under Voltage Trip Level	V_{IN} Rising		2.25	2.4	V
		V_{IN} Falling		1.95	2.1	V
V_{IN_OVLO}	Internal Over-Voltage Trip Level	V_{IN} Rising, OVLO=GND	6.6	6.8	7.0	V
		V_{IN} Falling	6.2			V
V_{OVLO_TH}	OVLO Set Threshold	$V_{IN}=2.5\text{V}$ to V_{OVLO}	1.18	1.20	1.22	
V_{OVLO_RNG}	Adjustable OVLO Threshold Range	$V_{IN}=2.5\text{V}$ to V_{OVLO}	4		25	V
V_{OVLO_SELECT}	External OVLO Select Threshold		0.28	0.30	0.32	V
R_{ON}	Resistance from V_{IN} to V_{OUT}	$V_{IN}=5\text{V}$, $I_{OUT}=1\text{A}$, $T_A=25^{\circ}\text{C}$	WLCSP-12	30		m Ω
			EP-SOIC8	60		
C_{OUT}	OUT Load Capacitance	$V_{IN}=5\text{V}$			1000	μF
I_{OLVO}	OVLO Input Leakage Current	$V_{OVLO}=V_{OVLO_TH}$	-100		100	nA
T_{SDN}	Thermal Shutdown			130		°C
T_{SDN_HYS}	Thermal Shutdown Hysteresis			20		°C

Digital Signals

V_{OL}	#ACOK Output Low Voltage	$I_{SINK}=1\text{mA}$			0.4	V
----------	--------------------------	-----------------------	--	--	-----	---



DIO1280

VIH_#EN	Enable HIGH Voltage	$V_{IN}=2.5V$ to V_{OVLO}	1.2			V
VIL_#EN	Enable LOW Voltage	$V_{IN}=2.5V$ to V_{OVLO}			0.5	V
I _{ACOK_LEAK}	#ACOK Leakage Current	$V_{ACOK}=3V$, #ACOK Deasserted	-0.5		0.5	μA
#EN_Leak	#EN Leakage Current	$V_{IN}=5.0V$, $V_{OUT}=Float$	-1.0		1.0	μA
Timing Characteristics						
t _{DEB}	Debounce Time	Time from $2.5V < V_{IN} < V_{IN_OVLO}$ to $V_{OUT}=0.1 \times V_{IN}$		15		ms
t _{START}	Soft-Start Time	Time from $V_{IN}=V_{IN_min}$ to $0.2 \times \#ACOK$, $V_{IO}=1.8V$ with $10k\Omega$ Pull-up Resistor		30		ms
t _{ON}	Switch Turn-On Time (Note 1)	$R_L=100\Omega$, $C_L=22\mu F$, V_{OUT} from $0.1 \times V_{IN}$ to $0.9 \times V_{IN}$	1.5	2	4	ms
t _{OFF}	Switch Turn-Off Time (Note 1)	$R_L=100\Omega$, $C_L=0\mu F$, $V_{IN} > V_{OVLO}$ to $V_{OUT}=0.8 \times V_{IN}$	80	125	200	ns

Specifications subject to change without notice.

Note 1: guaranteed by characterization under room temperature.

Timing Diagrams:

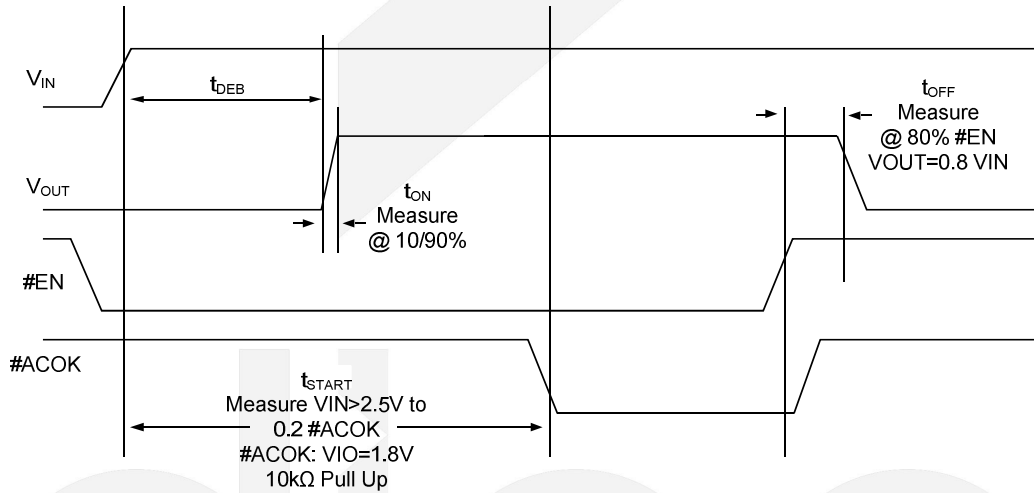

Figure 3 Timing for Power Up and Normal Operation

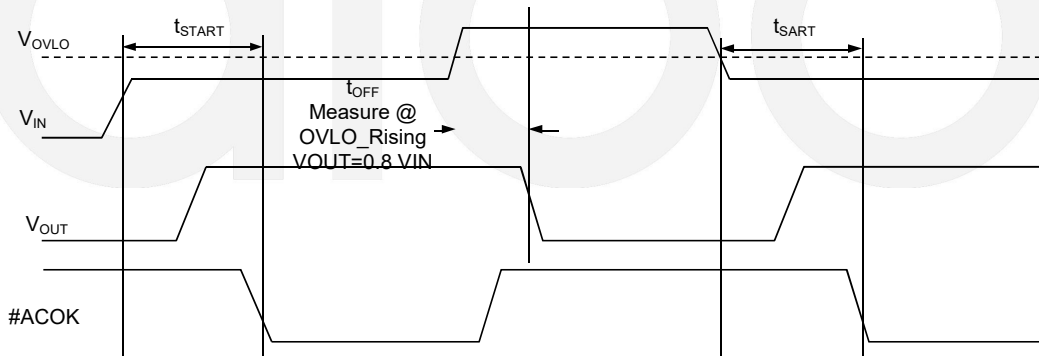
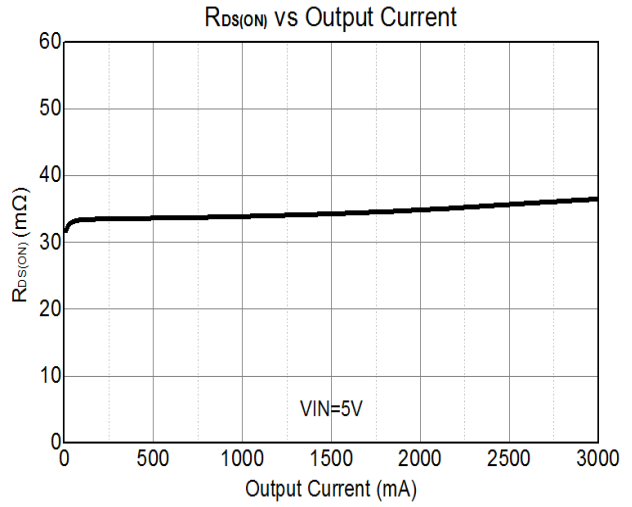
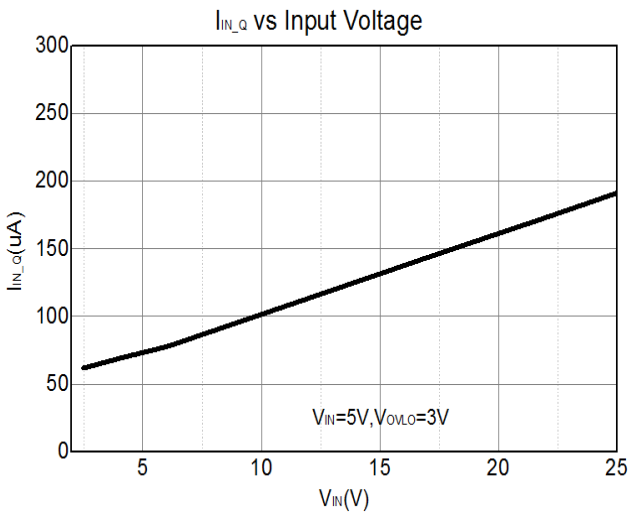

Figure 4 Timing for OVLO Trip

Typical Performance Characteristics

Ambient temperature is 25°C, $V_{IN}=5V$, $I_{IN}\leq 3A$, $C_{IN}=1\mu F$, $C_{OUT}=1\mu F$, unless otherwise noted.



VIN Power ON ($V_{IN}=5V$, No Load)

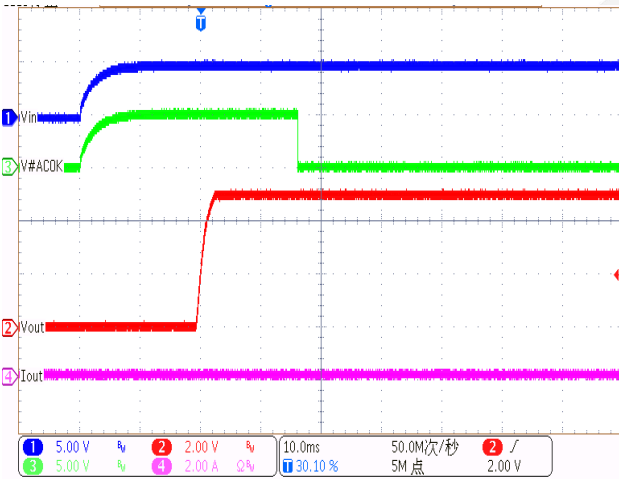

VIN Power OFF ($V_{IN}=5V$, No Load)

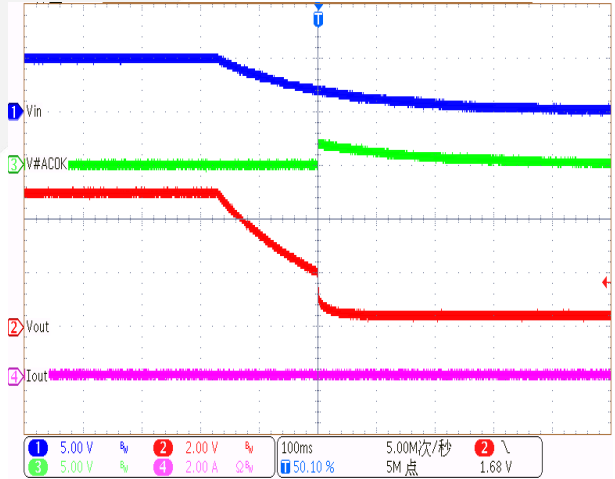

VIN Power ON ($V_{IN}=5V$, $R_{Load}=1.6ohm$)

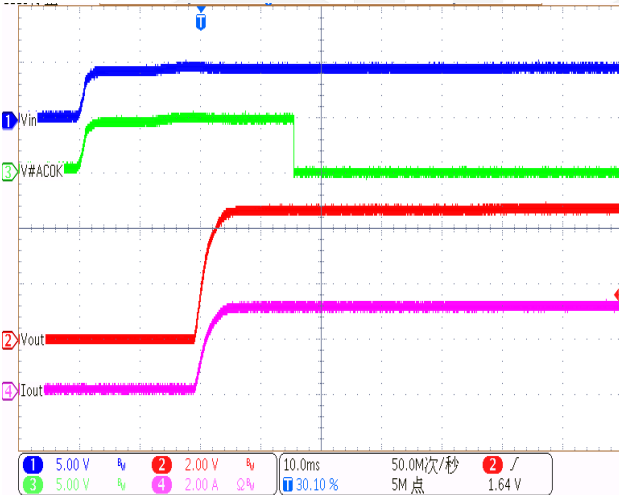

VIN Power OFF ($V_{IN}=5V$, $R_{Load}=1.6ohm$)

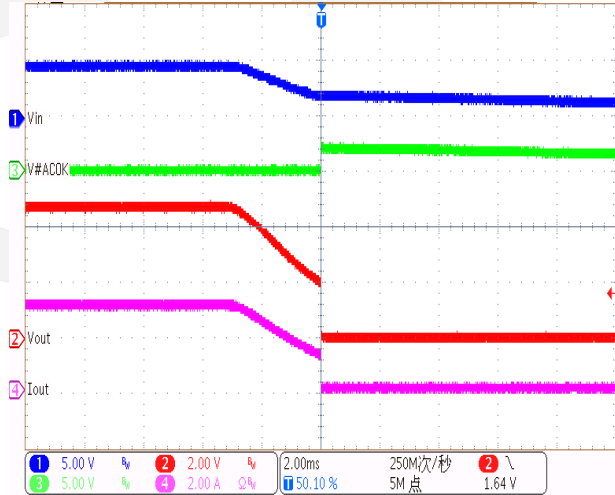

EN Power ON ($V_{IN}=5V$, No Load)

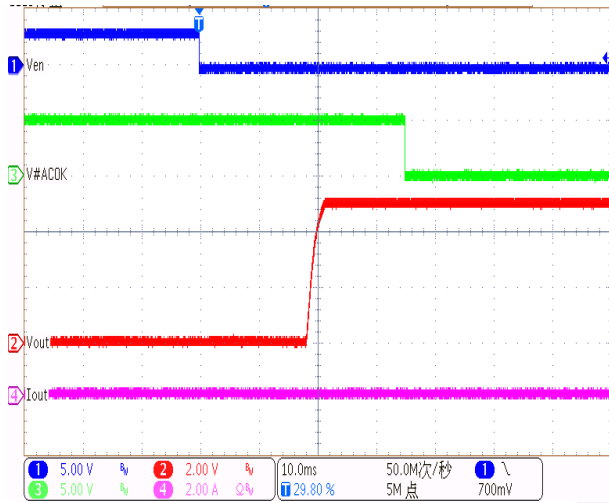

EN Power OFF ($V_{IN}=5V$, No Load)

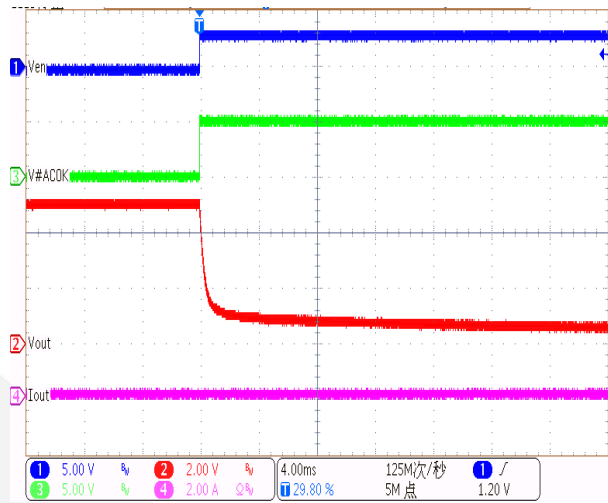

EN Power ON ($V_{IN}=5V$, $R_{Load}=1.6ohm$)

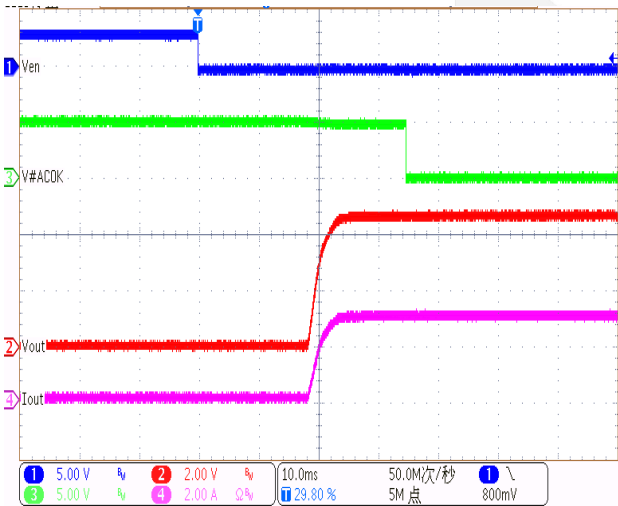

EN Power OFF ($V_{IN}=5V$, $R_{Load}=1.6ohm$)

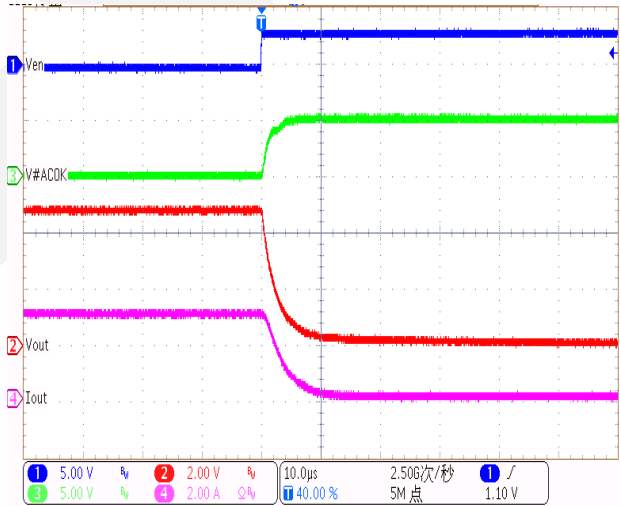



DIO1280

Over-Voltage Lockout (OVLO) Calculation:

OVLO can be set externally and override default OVP. By connecting an external resistor-driver to the OVLO pin. Equation (1) can produce the desired trip voltage and resistor values.

$$V_{IN_OVLO} = V_{OVLO_TH} \times [1 + R1 / R2] \quad (1)$$

Recommended minimum R1=820kΩ.

On-The-Go (OTG) Functionality:

During OTG operation, the DIO1280 is initially disabled and the power FET's bulk diode is forward biased. The bulk diode represents ~0.7V drop across the device, which remains until the V_IN voltage increases past 2.5V, when the device is fully enabled. While the device is disabled and the body diode is forward biased, the max DC current through the diode is 1.8A. This current is limited by the thermal performance of the device (0.7V x 1.8A=1.36W). The #EN pin must be pulled LOW to ensure the device fully enables and the transient should not exceed the RC time constant of the C_IN and C_OUT capacitors. At the system level, over-voltage and current protection should be provided outside the DIO1280.



Physical Dimensions: WLCSP-12 0.4mm pitch

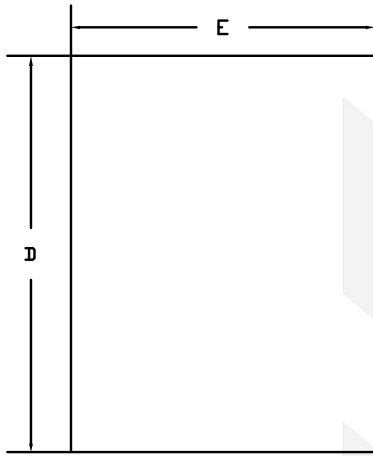

TOP VIEW
(MARK SIDE)

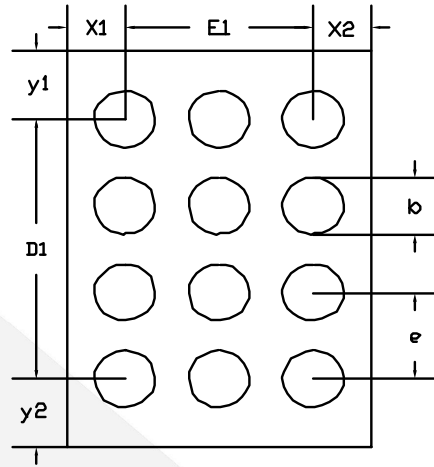

BOTTOM VIEW
(BALL SIDE)

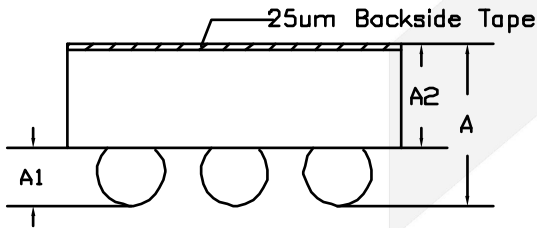

SIDE VIEW

COMMON DIMENSIONS (UNITS OF MEASURE=MILLIMETER)			
Symbol	MIN	NOM	MAX
A	0.567	0.607	0.647
A1	0.182	0.202	0.222
A2	0.385	0.405	0.425
D	1.808	1.828	1.848
D1	1.200BSC		
E	1.268	1.288	1.308
E1	0.800BSC		
b	0.230	0.260	0.290
e	0.400BSC		
x1	0.244REF		
x2	0.244REF		
y1	0.314REF		
y2	0.314REF		

Physical Dimensions: EP-SOIC8

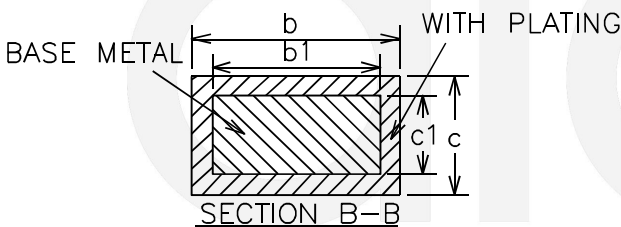
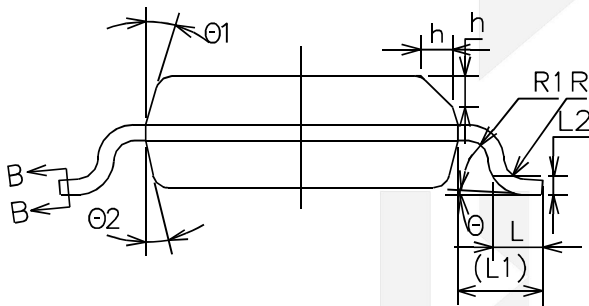
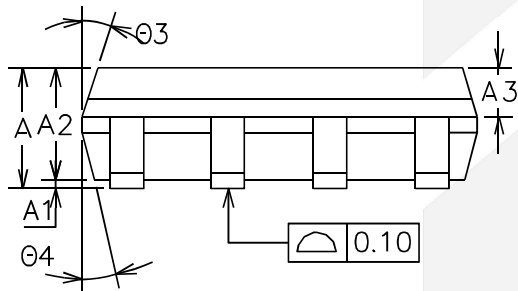
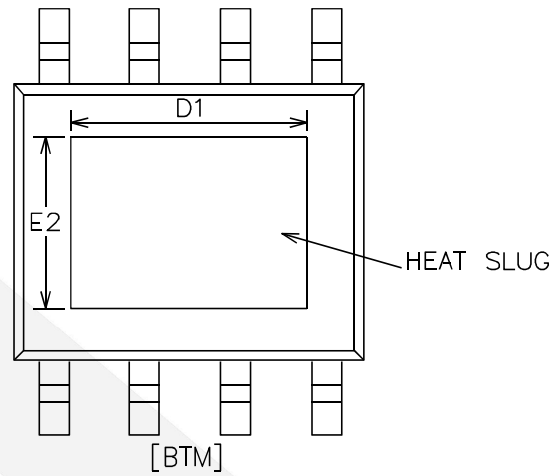
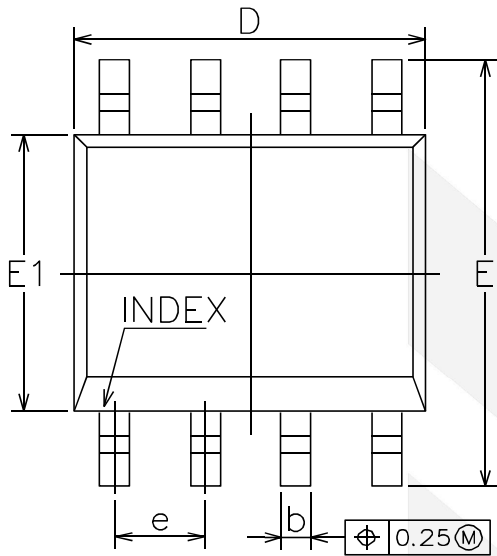

COMMON DIMENSIONS (UNITS OF MEASURE=MILLIMETER)			
Symbol	MIN	NOM	MAX
A	1.35	1.55	1.70
A1	0	0.10	0.15
A2	1.25	1.40	1.65
A3	0.50	0.60	0.70
b	0.38	-	0.51
b1	0.37	0.42	0.47
c	0.17	-	0.25
c1	0.17	0.20	0.23
D	4.80	4.90	5.00
D1	3.10	3.30	3.50
E	5.80	6.00	6.20
E1	3.80	3.90	4.00
E2	2.20	2.40	2.60
e	1.17	1.27	1.37
L	0.45	0.69	0.80
L1	1.04REF		
L2	0.25BSC		
R	0.07	-	-
R1	0.07	-	-
h	0.30	0.40	0.50
θ	0°	-	8°
θ1	15°	17°	19°
θ2	11°	13°	15°
θ3	15°	17°	19°
θ4	11°	13°	15°



DIO1280

Over-Voltage Protection Load Switch

CONTACT US

Dioo is a professional design and sales corporation for high-quality and performance analog semiconductors. The company focuses on industry markets, such as, cell phone, handheld products, laptop, and medical equipment and so on. Dioo's product families include analog signal processing and amplifying, LED drivers and charger IC. Go to <http://www.dioo.com> for a complete list of Dioo product families.

For additional product information, or full datasheet, please contact with our Sales Department or Representatives.

dioo



Компания «ЭлектроПласт» предлагает заключение долгосрочных отношений при поставках импортных электронных компонентов на взаимовыгодных условиях!

Наши преимущества:

- Оперативные поставки широкого спектра электронных компонентов отечественного и импортного производства напрямую от производителей и с крупнейших мировых складов;
- Поставка более 17-ти миллионов наименований электронных компонентов;
- Поставка сложных, дефицитных, либо снятых с производства позиций;
- Оперативные сроки поставки под заказ (от 5 рабочих дней);
- Экспресс доставка в любую точку России;
- Техническая поддержка проекта, помощь в подборе аналогов, поставка прототипов;
- Система менеджмента качества сертифицирована по Международному стандарту ISO 9001;
- Лицензия ФСБ на осуществление работ с использованием сведений, составляющих государственную тайну;
- Поставка специализированных компонентов (Xilinx, Altera, Analog Devices, Intersil, Interpoint, Microsemi, Aeroflex, Peregrine, Syfer, Eurofarad, Texas Instrument, Miteq, Cobham, E2V, MA-COM, Hittite, Mini-Circuits, General Dynamics и др.);

Помимо этого, одним из направлений компании «ЭлектроПласт» является направление «Источники питания». Мы предлагаем Вам помощь Конструкторского отдела:

- Подбор оптимального решения, техническое обоснование при выборе компонента;
- Подбор аналогов;
- Консультации по применению компонента;
- Поставка образцов и прототипов;
- Техническая поддержка проекта;
- Защита от снятия компонента с производства.



Как с нами связаться

Телефон: 8 (812) 309 58 32 (многоканальный)

Факс: 8 (812) 320-02-42

Электронная почта: org@eplast1.ru

Адрес: 198099, г. Санкт-Петербург, ул. Калинина, дом 2, корпус 4, литера А.