

	E480232
-----------------------------------------------------------------------------------	----------------

Features

- Fast Response Time
- Glass Passivated Junction
- Plastic Package Devices and Low Incremental Surge Resistance
- High Temperature Soldering Guaranteed
- Halogen Free Available Upon Request By Adding Suffix "-HF"
- Moisture Sensitivity Level 1
- Epoxy Meets UL 94 V-0 Flammability Rating
- Lead Free Finish/RoHS Compliant (Note1) ("P" Suffix Designates RoHS Compliant. See Ordering Information)
- For Bidirectional Devices Add "C" To The Suffix of The Part Number: i.e.30KP28CA for 5% Tolerance

Mechanical Data

- Polarity :Color Band Denotes Cathodes Except Bipolar
- Weight: 0.07 ounce, 2.5 grams
- Terminals: Plated Axial leads, Solderable Per MIL-STD-750, Methode 2026

Maximum Ratings

- Operating Junction Temperature Range: -55°C to +175°C
- Storage Temperature Range: -55°C to +175°C

Peak Pulse Power Dissipation with a 10/1000µs Waveform	P_{PPM}	30000W(Min.)	
Steady State Power Dissipation	$P_{M(AV)}$	8.0 W	$T_L=75^\circ\text{C}$, Lead lengths.375", (9.5mm)
Response Time	typically less than 1.0ps from 0 Volts to BV		
	bidirectional less than 10ns		

Note: 1. High Temperature Solder Exemptions Applied, see EU Directive Annex 7a.

Pin Configuration:

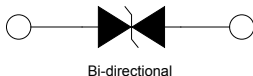
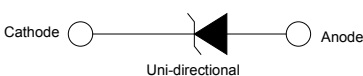

**30000Watts TVS
28 to 288 Volts**

R-6

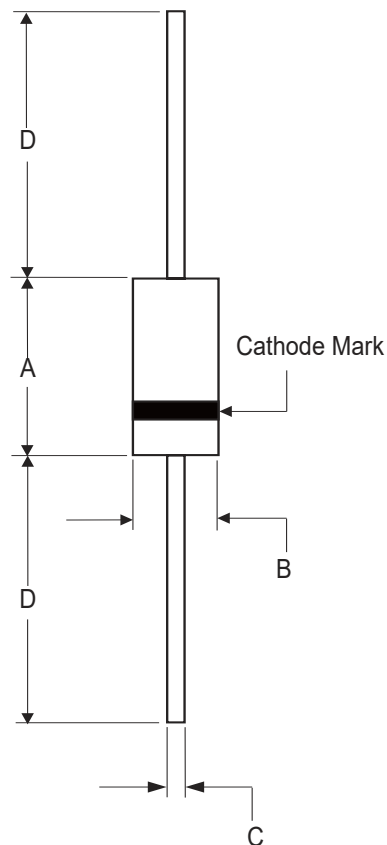

DIM	INCHES		MM		NOTE
	MIN	MAX	MIN	MAX	
A	0.340	0.360	8.60	9.10	
B	0.340	0.360	8.60	9.10	
C	0.048	0.052	1.20	1.32	
D	1.000	-----	25.40	-----	

Electrical Characteristics @ 25°C Unless Otherwise Specified

PART NUMBER		REVERSE STAND- OFF VOLTAGE $V_{RWM}(V)$	BREAKDOWN VOLTAGE $V_{BR}(V)$ MIN. @ I_T	BREAKDOWN VOLTAGE $V_{BR}(V)$ MAX. @ I_T	TEST CURRENT I_T (mA)	PEAK PULSE CURRENT I_{PP} (A)	REVERSE LEAKAGE @ V_{RWM} $I_R(\mu A)$	MAXIMUM CLAMPING VOLTAGE@ I_{PP} $V_C(V)$
UNI-POLAR	BI-POLAR							
30KP28A	30KP28CA	28	31.28	34.24	50	606	5000	50
30KP30A	30KP30CA	30	33.51	36.69	50	548.9	5000	55.2
30KP33A	30KP33CA	33	36.9	40.4	50	517.9	5000	58.5
30KP36A	30KP36CA	36	40.2	44	50	490.3	5000	61.8
30KP39A	30KP39CA	39	43.6	47.7	20	450.9	2000	67.2
30KP42A	30KP42CA	42	46.9	51.4	10	420.8	1000	72
30KP43A	30KP43CA	43	48	52.6	10	415.1	1000	73
30KP45A	30KP45CA	45	50.3	55	5	391.5	250	77.4
30KP48A	30KP48CA	48	53.6	58.7	5	371.3	150	81.6
30KP51A	30KP51CA	51	57	62.4	5	350.7	50	86.4
30KP54A	30KP54CA	54	60.3	66	5	331.5	20	91.4
30KP58A	30KP58CA	58	64.8	70.9	5	327.9	20	92.4
30KP60A	30KP60CA	60	67	73.4	5	297.1	15	102
30KP64A	30KP64CA	64	71.5	78.3	5	291.3	10	104
30KP66A	30KP66CA	66	73.7	80.7	5	283.2	10	107
30KP70A	30KP70CA	70	78.2	85.6	5	278	10	109
30KP71A	30KP71CA	71	79.3	86.8	5	271.7	10	111.5
30KP72A	30KP72CA	72	80.4	88.1	5	265.8	10	114
30KP75A	30KP75CA	75	83.8	91.7	5	253.8	10	119.4
30KP78A	30KP78CA	78	87.1	95.4	5	234.9	10	129
30KP84A	30KP84CA	84	93.8	102.7	5	217.7	10	139.2
30KP90A	30KP90CA	90	100.5	110.1	5	207	10	146.4
30KP96A	30KP96CA	96	107.2	117.4	5	194.2	10	156
30KP102A	30KP102CA	102	113.9	124.7	5	183	10	165.6
30KP108A	30KP108CA	108	120.6	132.1	5	172.9	10	175.2
30KP120A	30KP120CA	120	134	146.8	5	155.9	10	194.4
30KP132A	30KP132CA	132	147.4	161.4	5	142.3	10	213
30KP144A	30KP144CA	144	160.8	176.1	5	135.8	10	223.2
30KP150A	30KP150CA	150	167.6	183.5	5	129.8	10	233.4
30KP156A	30KP156CA	156	174.3	190.8	5	123.7	10	245
30KP160A	30KP160CA	160	178.7	195.7	5	120	10	252.6
30KP168A	30KP168CA	168	187.7	205.5	5	111.2	10	272.4
30KP170A	30KP170CA	170	189.9	207.9	5	110.2	10	275
30KP180A	30KP180CA	180	201.1	220.1	5	104.3	10	290.4
30KP198A	30KP198CA	198	221.2	242.2	5	94.7	10	319.8
30KP216A	30KP216CA	216	241.3	264.2	5	86.9	10	348.6
30KP240A	30KP240CA	240	268.1	293.5	5	78.3	10	387
30KP258A	30KP258CA	258	288.2	315.5	5	72.8	10	416.4
30KP260A	30KP260CA	260	290.4	318	5	72.8	10	416
30KP270A	30KP270CA	270	301.6	330.2	5	69.5	10	436.2
30KP280A	30KP280CA	280	312.8	342.4	5	65.3	10	464
30KP288A	30KP288CA	288	321.7	352.2	5	64.5	10	469.9

For bi-directional type having V_{RWM} of 60 volts and less , the I_R limit is double.
 For parts without A , the V_{BR} is $\pm 10\%$

Curve Characteristics

Fig. 1 - Peak Pulse Power Rating Curve

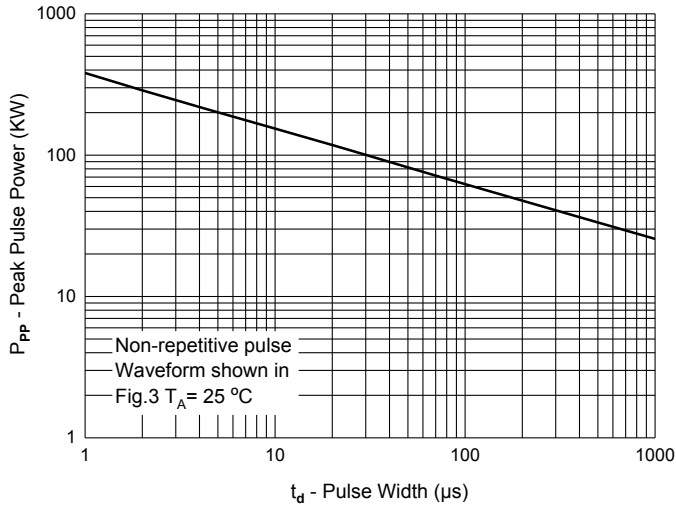

Fig. 2 - Typical Junction Capacitance

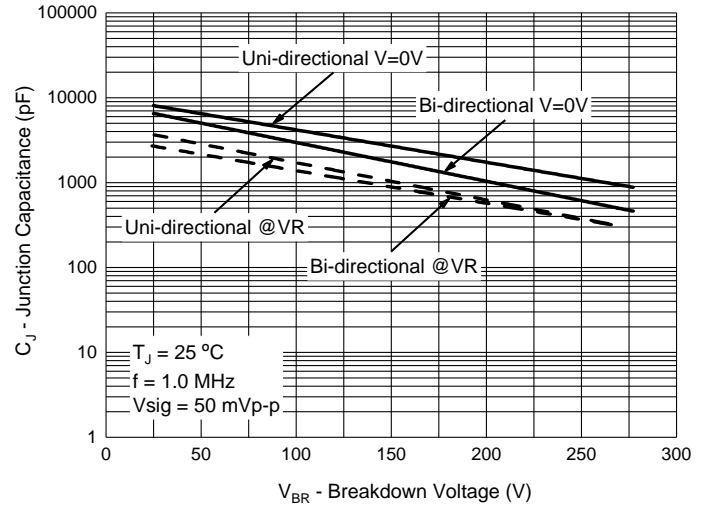

Fig. 3 - Pulse Waveform

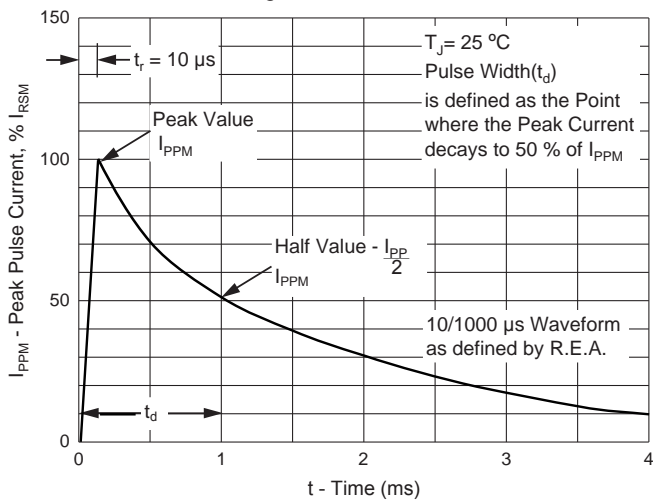
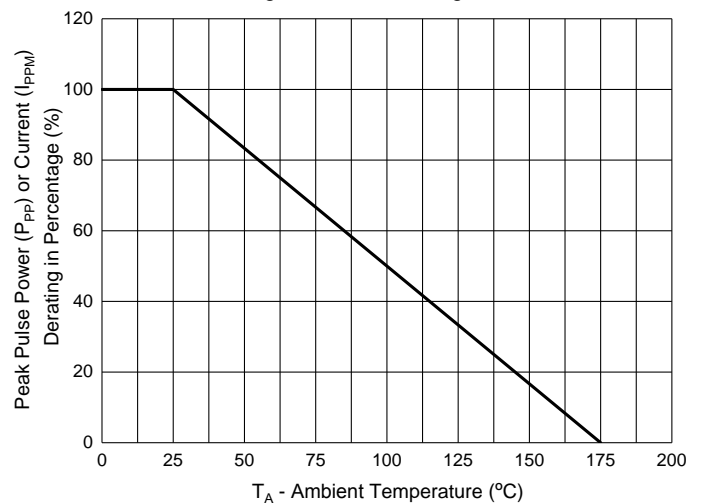

Fig. 4 - Pulse Derating Curve



Ordering Information

Device	Packing
(Part Number)-TP	Tape&Reel: 500pcs/Reel
(Part Number)-AP	Ammo Packing: 450pcs/Ammo Box
(Part Number)-BP	Bulk: 4.8Kpcs/Carton

Note : Adding "-HF" Suffix For Halogen Free, eg. Part Number-TP-HF

IMPORTANT NOTICE

Micro Commercial Components Corp. reserves the right to make changes without further notice to any product herein to make corrections, modifications , enhancements , improvements , or other changes . **Micro Commercial Components Corp** . does not assume any liability arising out of the application or use of any product described herein; neither does it convey any license under its patent rights ,nor the rights of others . The user of products in such applications shall assume all risks of such use and will agree to hold **Micro Commercial Components Corp** . and all the companies whose products are represented on our website, harmless against all damages.

LIFE SUPPORT

MCC's products are not authorized for use as critical components in life support devices or systems without the express written approval of Micro Commercial Components Corporation.

CUSTOMER AWARENESS

Counterfeiting of semiconductor parts is a growing problem in the industry. Micro Commercial Components (MCC) is taking strong measures to protect ourselves and our customers from the proliferation of counterfeit parts. MCC strongly encourages customers to purchase MCC parts either directly from MCC or from Authorized MCC Distributors who are listed by country on our web page cited below. Products customers buy either from MCC directly or from Authorized MCC Distributors are genuine parts, have full traceability, meet MCC's quality standards for handling and storage. **MCC will not provide any warranty coverage or other assistance for parts bought from Unauthorized Sources.** MCC is committed to combat this global problem and encourage our customers to do their part in stopping this practice by buying direct or from authorized distributors.



Компания «ЭлектроПласт» предлагает заключение долгосрочных отношений при поставках импортных электронных компонентов на взаимовыгодных условиях!

Наши преимущества:

- Оперативные поставки широкого спектра электронных компонентов отечественного и импортного производства напрямую от производителей и с крупнейших мировых складов;
- Поставка более 17-ти миллионов наименований электронных компонентов;
- Поставка сложных, дефицитных, либо снятых с производства позиций;
- Оперативные сроки поставки под заказ (от 5 рабочих дней);
- Экспресс доставка в любую точку России;
- Техническая поддержка проекта, помощь в подборе аналогов, поставка прототипов;
- Система менеджмента качества сертифицирована по Международному стандарту ISO 9001;
- Лицензия ФСБ на осуществление работ с использованием сведений, составляющих государственную тайну;
- Поставка специализированных компонентов (Xilinx, Altera, Analog Devices, Intersil, Interpoint, Microsemi, Aeroflex, Peregrine, Syfer, Eurofarad, Texas Instrument, Miteq, Cobham, E2V, MA-COM, Hittite, Mini-Circuits, General Dynamics и др.);

Помимо этого, одним из направлений компании «ЭлектроПласт» является направление «Источники питания». Мы предлагаем Вам помощь Конструкторского отдела:

- Подбор оптимального решения, техническое обоснование при выборе компонента;
- Подбор аналогов;
- Консультации по применению компонента;
- Поставка образцов и прототипов;
- Техническая поддержка проекта;
- Защита от снятия компонента с производства.



Как с нами связаться

Телефон: 8 (812) 309 58 32 (многоканальный)

Факс: 8 (812) 320-02-42

Электронная почта: org@eplast1.ru

Адрес: 198099, г. Санкт-Петербург, ул. Калинина, дом 2, корпус 4, литера А.