

|   |                |
|---|----------------|
|  | <b>E480232</b> |
|---|----------------|

**Features**

- Fast Response Time
- Glass Passivated Junction
- Plastic Package Devices and Low Incremental Surge Resistance
- High Temperature Soldering Guaranteed
- Halogen Free Available Upon Request By Adding Suffix "-HF"
- Moisture Sensitivity Level 1
- Epoxy Meets UL 94 V-0 Flammability Rating
- Lead Free Finish/RoHS Compliant (Note1) ("P" Suffix Designates RoHS Compliant. See Ordering Information)
- For Bidirectional Devices Add "C" To The Suffix of The Part Number: i.e.30KP28CA for 5% Tolerance

**Mechanical Data**

- Polarity :Color Band Denotes Cathodes Except Bipolar
- Weight: 0.07 ounce, 2.5 grams
- Terminals: Plated Axial leads, Solderable Per MIL-STD-750, Methode 2026

**Maximum Ratings**

- Operating Junction Temperature Range: -55°C to +175°C
- Storage Temperature Range: -55°C to +175°C

|  |  |              |   |
|--|--|--------------|---|
| Peak Pulse Power Dissipation with a 10/1000µs Waveform | $P_{PPM}$                                    | 30000W(Min.) |   |
| Steady State Power Dissipation                         | $P_{M(AV)}$                                  | 8.0 W        | $T_L=75^\circ\text{C}$ , Lead lengths.375", (9.5mm) |
| Response Time  | typically less than 1.0ps from 0 Volts to BV |              |   |
|  | bidirectional less than 10ns                 |              |   |

Note: 1. High Temperature Solder Exemptions Applied, see EU Directive Annex 7a.

Pin Configuration:

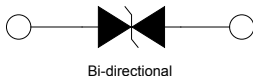
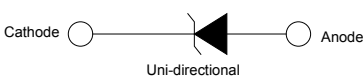

**30000Watts TVS  
28 to 288 Volts**

R-6

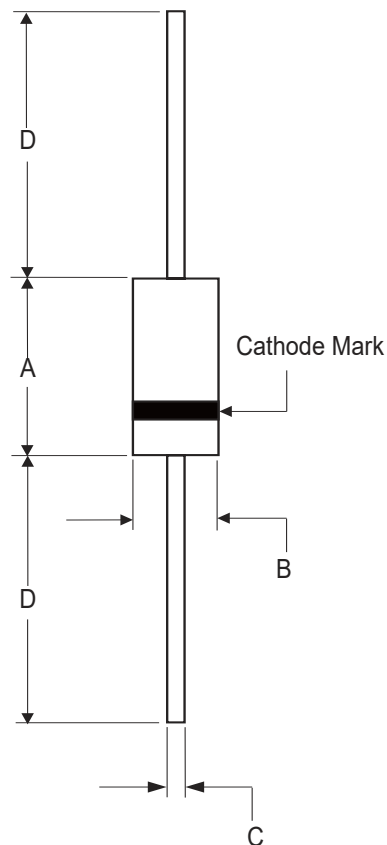

| DIM | INCHES |       | MM    |       | NOTE |
|-----|--------|-------|-------|-------|------|
|     | MIN    | MAX   | MIN   | MAX   |      |
| A   | 0.340  | 0.360 | 8.60  | 9.10  |      |
| B   | 0.340  | 0.360 | 8.60  | 9.10  |      |
| C   | 0.048  | 0.052 | 1.20  | 1.32  |      |
| D   | 1.000  | ----- | 25.40 | ----- |      |

**Electrical Characteristics @ 25°C Unless Otherwise Specified**

| PART NUMBER |           | REVERSE<br>STAND- OFF<br>VOLTAGE<br>$V_{RWM}(V)$ | BREAKDOWN<br>VOLTAGE $V_{BR}(V)$<br>MIN. @ $I_T$ | BREAKDOWN<br>VOLTAGE $V_{BR}(V)$<br>MAX. @ $I_T$ | TEST<br>CURRENT<br>$I_T$ (mA) | PEAK<br>PULSE<br>CURRENT<br>$I_{PP}$ (A) | REVERSE<br>LEAKAGE<br>@ $V_{RWM}$<br>$I_R(\mu A)$ | MAXIMUM<br>CLAMPING<br>VOLTAGE@ $I_{PP}$<br>$V_C(V)$ |
|-------------|-----------|--|--|--|-------------------------------|--|---|--|
| UNI-POLAR   | BI-POLAR  |  |  |  |                               |  |   |  |
| 30KP28A     | 30KP28CA  | 28   | 31.28  | 34.24  | 50                            | 606                                      | 5000  | 50   |
| 30KP30A     | 30KP30CA  | 30   | 33.51  | 36.69  | 50                            | 548.9                                    | 5000  | 55.2   |
| 30KP33A     | 30KP33CA  | 33   | 36.9   | 40.4   | 50                            | 517.9                                    | 5000  | 58.5   |
| 30KP36A     | 30KP36CA  | 36   | 40.2   | 44   | 50                            | 490.3                                    | 5000  | 61.8   |
| 30KP39A     | 30KP39CA  | 39   | 43.6   | 47.7   | 20                            | 450.9                                    | 2000  | 67.2   |
| 30KP42A     | 30KP42CA  | 42   | 46.9   | 51.4   | 10                            | 420.8                                    | 1000  | 72   |
| 30KP43A     | 30KP43CA  | 43   | 48   | 52.6   | 10                            | 415.1                                    | 1000  | 73   |
| 30KP45A     | 30KP45CA  | 45   | 50.3   | 55   | 5                             | 391.5                                    | 250   | 77.4   |
| 30KP48A     | 30KP48CA  | 48   | 53.6   | 58.7   | 5                             | 371.3                                    | 150   | 81.6   |
| 30KP51A     | 30KP51CA  | 51   | 57   | 62.4   | 5                             | 350.7                                    | 50  | 86.4   |
| 30KP54A     | 30KP54CA  | 54   | 60.3   | 66   | 5                             | 331.5                                    | 20  | 91.4   |
| 30KP58A     | 30KP58CA  | 58   | 64.8   | 70.9   | 5                             | 327.9                                    | 20  | 92.4   |
| 30KP60A     | 30KP60CA  | 60   | 67   | 73.4   | 5                             | 297.1                                    | 15  | 102  |
| 30KP64A     | 30KP64CA  | 64   | 71.5   | 78.3   | 5                             | 291.3                                    | 10  | 104  |
| 30KP66A     | 30KP66CA  | 66   | 73.7   | 80.7   | 5                             | 283.2                                    | 10  | 107  |
| 30KP70A     | 30KP70CA  | 70   | 78.2   | 85.6   | 5                             | 278                                      | 10  | 109  |
| 30KP71A     | 30KP71CA  | 71   | 79.3   | 86.8   | 5                             | 271.7                                    | 10  | 111.5  |
| 30KP72A     | 30KP72CA  | 72   | 80.4   | 88.1   | 5                             | 265.8                                    | 10  | 114  |
| 30KP75A     | 30KP75CA  | 75   | 83.8   | 91.7   | 5                             | 253.8                                    | 10  | 119.4  |
| 30KP78A     | 30KP78CA  | 78   | 87.1   | 95.4   | 5                             | 234.9                                    | 10  | 129  |
| 30KP84A     | 30KP84CA  | 84   | 93.8   | 102.7  | 5                             | 217.7                                    | 10  | 139.2  |
| 30KP90A     | 30KP90CA  | 90   | 100.5  | 110.1  | 5                             | 207                                      | 10  | 146.4  |
| 30KP96A     | 30KP96CA  | 96   | 107.2  | 117.4  | 5                             | 194.2                                    | 10  | 156  |
| 30KP102A    | 30KP102CA | 102  | 113.9  | 124.7  | 5                             | 183                                      | 10  | 165.6  |
| 30KP108A    | 30KP108CA | 108  | 120.6  | 132.1  | 5                             | 172.9                                    | 10  | 175.2  |
| 30KP120A    | 30KP120CA | 120  | 134  | 146.8  | 5                             | 155.9                                    | 10  | 194.4  |
| 30KP132A    | 30KP132CA | 132  | 147.4  | 161.4  | 5                             | 142.3                                    | 10  | 213  |
| 30KP144A    | 30KP144CA | 144  | 160.8  | 176.1  | 5                             | 135.8                                    | 10  | 223.2  |
| 30KP150A    | 30KP150CA | 150  | 167.6  | 183.5  | 5                             | 129.8                                    | 10  | 233.4  |
| 30KP156A    | 30KP156CA | 156  | 174.3  | 190.8  | 5                             | 123.7                                    | 10  | 245  |
| 30KP160A    | 30KP160CA | 160  | 178.7  | 195.7  | 5                             | 120                                      | 10  | 252.6  |
| 30KP168A    | 30KP168CA | 168  | 187.7  | 205.5  | 5                             | 111.2                                    | 10  | 272.4  |
| 30KP170A    | 30KP170CA | 170  | 189.9  | 207.9  | 5                             | 110.2                                    | 10  | 275  |
| 30KP180A    | 30KP180CA | 180  | 201.1  | 220.1  | 5                             | 104.3                                    | 10  | 290.4  |
| 30KP198A    | 30KP198CA | 198  | 221.2  | 242.2  | 5                             | 94.7                                     | 10  | 319.8  |
| 30KP216A    | 30KP216CA | 216  | 241.3  | 264.2  | 5                             | 86.9                                     | 10  | 348.6  |
| 30KP240A    | 30KP240CA | 240  | 268.1  | 293.5  | 5                             | 78.3                                     | 10  | 387  |
| 30KP258A    | 30KP258CA | 258  | 288.2  | 315.5  | 5                             | 72.8                                     | 10  | 416.4  |
| 30KP260A    | 30KP260CA | 260  | 290.4  | 318  | 5                             | 72.8                                     | 10  | 416  |
| 30KP270A    | 30KP270CA | 270  | 301.6  | 330.2  | 5                             | 69.5                                     | 10  | 436.2  |
| 30KP280A    | 30KP280CA | 280  | 312.8  | 342.4  | 5                             | 65.3                                     | 10  | 464  |
| 30KP288A    | 30KP288CA | 288  | 321.7  | 352.2  | 5                             | 64.5                                     | 10  | 469.9  |

For bi-directional type having  $V_{RWM}$  of 60 volts and less , the  $I_R$  limit is double.  
 For parts without A , the  $V_{BR}$  is  $\pm 10\%$

**Curve Characteristics**

Fig. 1 - Peak Pulse Power Rating Curve

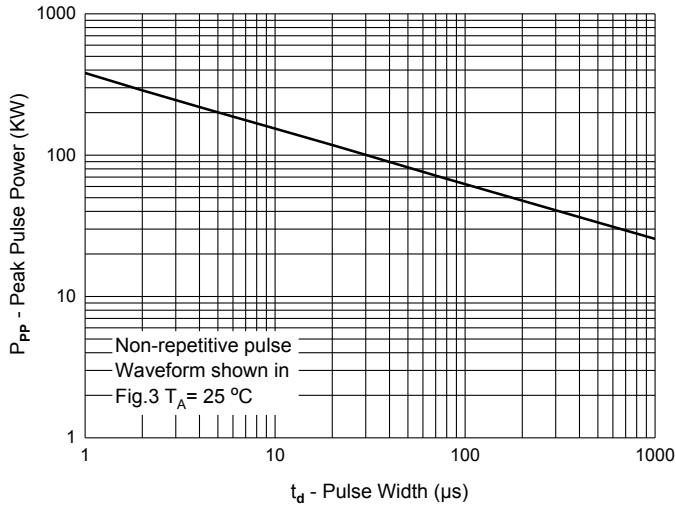

Fig. 2 - Typical Junction Capacitance

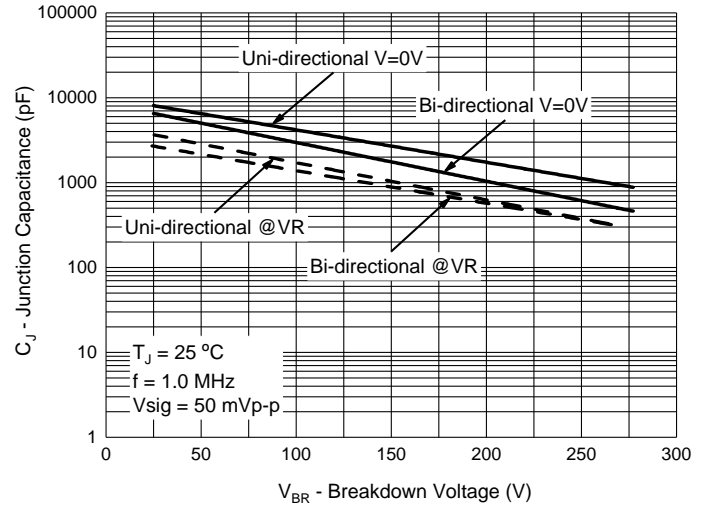

Fig. 3 - Pulse Waveform

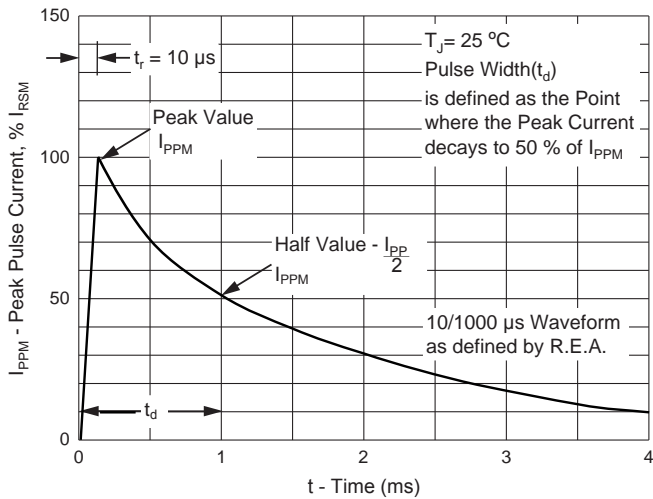
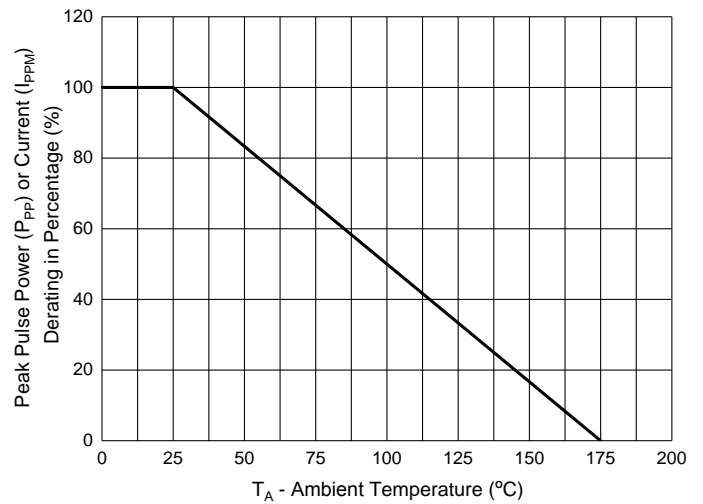

Fig. 4 - Pulse Derating Curve



## Ordering Information

| Device           | Packing                       |
|------------------|-------------------------------|
| (Part Number)-TP | Tape&Reel: 500pcs/Reel        |
| (Part Number)-AP | Ammo Packing: 450pcs/Ammo Box |
| (Part Number)-BP | Bulk: 4.8Kpcs/Carton          |

Note : Adding "-HF" Suffix For Halogen Free, eg. Part Number-TP-HF

### \*\*\*IMPORTANT NOTICE\*\*\*

**Micro Commercial Components Corp.** reserves the right to make changes without further notice to any product herein to make corrections, modifications , enhancements , improvements , or other changes . **Micro Commercial Components Corp** . does not assume any liability arising out of the application or use of any product described herein; neither does it convey any license under its patent rights ,nor the rights of others . The user of products in such applications shall assume all risks of such use and will agree to hold **Micro Commercial Components Corp** . and all the companies whose products are represented on our website, harmless against all damages.

### \*\*\*LIFE SUPPORT\*\*\*

MCC's products are not authorized for use as critical components in life support devices or systems without the express written approval of Micro Commercial Components Corporation.

### \*\*\*CUSTOMER AWARENESS\*\*\*

Counterfeiting of semiconductor parts is a growing problem in the industry. Micro Commercial Components (MCC) is taking strong measures to protect ourselves and our customers from the proliferation of counterfeit parts. MCC strongly encourages customers to purchase MCC parts either directly from MCC or from Authorized MCC Distributors who are listed by country on our web page cited below. Products customers buy either from MCC directly or from Authorized MCC Distributors are genuine parts, have full traceability, meet MCC's quality standards for handling and storage. **MCC will not provide any warranty coverage or other assistance for parts bought from Unauthorized Sources.** MCC is committed to combat this global problem and encourage our customers to do their part in stopping this practice by buying direct or from authorized distributors.



Компания «ЭлектроПласт» предлагает заключение долгосрочных отношений при поставках импортных электронных компонентов на взаимовыгодных условиях!

Наши преимущества:

- Оперативные поставки широкого спектра электронных компонентов отечественного и импортного производства напрямую от производителей и с крупнейших мировых складов;
- Поставка более 17-ти миллионов наименований электронных компонентов;
- Поставка сложных, дефицитных, либо снятых с производства позиций;
- Оперативные сроки поставки под заказ (от 5 рабочих дней);
- Экспресс доставка в любую точку России;
- Техническая поддержка проекта, помощь в подборе аналогов, поставка прототипов;
- Система менеджмента качества сертифицирована по Международному стандарту ISO 9001;
- Лицензия ФСБ на осуществление работ с использованием сведений, составляющих государственную тайну;
- Поставка специализированных компонентов (Xilinx, Altera, Analog Devices, Intersil, Interpoint, Microsemi, Aeroflex, Peregrine, Syfer, Eurofarad, Texas Instrument, Miteq, Cobham, E2V, MA-COM, Hittite, Mini-Circuits, General Dynamics и др.);

Помимо этого, одним из направлений компании «ЭлектроПласт» является направление «Источники питания». Мы предлагаем Вам помощь Конструкторского отдела:

- Подбор оптимального решения, техническое обоснование при выборе компонента;
- Подбор аналогов;
- Консультации по применению компонента;
- Поставка образцов и прототипов;
- Техническая поддержка проекта;
- Защита от снятия компонента с производства.



#### Как с нами связаться

**Телефон:** 8 (812) 309 58 32 (многоканальный)

**Факс:** 8 (812) 320-02-42

**Электронная почта:** [org@eplast1.ru](mailto:org@eplast1.ru)

**Адрес:** 198099, г. Санкт-Петербург, ул. Калинина, дом 2, корпус 4, литера А.