

# MSG series

Rugged switch guards for switch series 12000 - 3500 - 600H - 6000



## DISTINCTIVE FEATURES

Robust

For harsh environments

Modern, patented design



## GENERAL SPECIFICATIONS

- APEM SAS patented design
- Operating temperature : -40 °C to +85 °C (-40 °F to +185 °F)
- Storage temperature : -55 °C to +85 °C (-67 °F to +185 °F)
- Salt spray : IEC 60068-2-11, test KA, 96 hours
- Mechanical life : 20,000 cycles
- Switch guards are designed to prevent accidental lever operation on switches with Ø 11.9 (.468) or Ø 12 (.472) threaded bushing and lever length 17.5 (.688) outside bushing.  
When the guard is raised, the lever can be operated freely.  
When the guard is fully depressed, the lever is reset/locked in a stable position.  
Note : For correct switch operation, the switch guard should be adjusted properly (see "Mounting" below).



## MATERIALS

- Support plate : black stainless steel
- Cap : thermoset

APEM products may be recycled at end-of-life for the re-claiming of valuable metal components.



## PANEL CUT-OUT

FOR BUSHING WITH KEYWAY

FOR FLATTED BUSHING

K

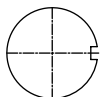

F

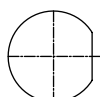

The company reserves the right to change specifications without notice.



# MSG series

Rugged switch guards for switch series 12000 - 3500 - 600H - 6000



## MOUNTING

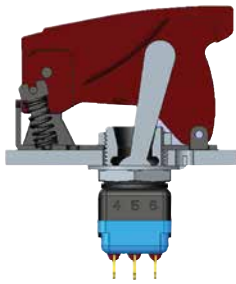

Standard

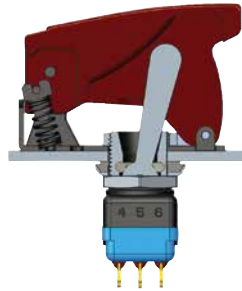

With K sealing option

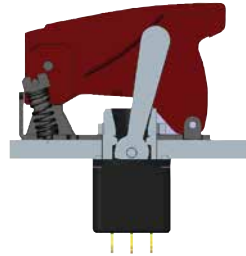

With X408 sealing option



## BUILD YOUR PART NUMBER

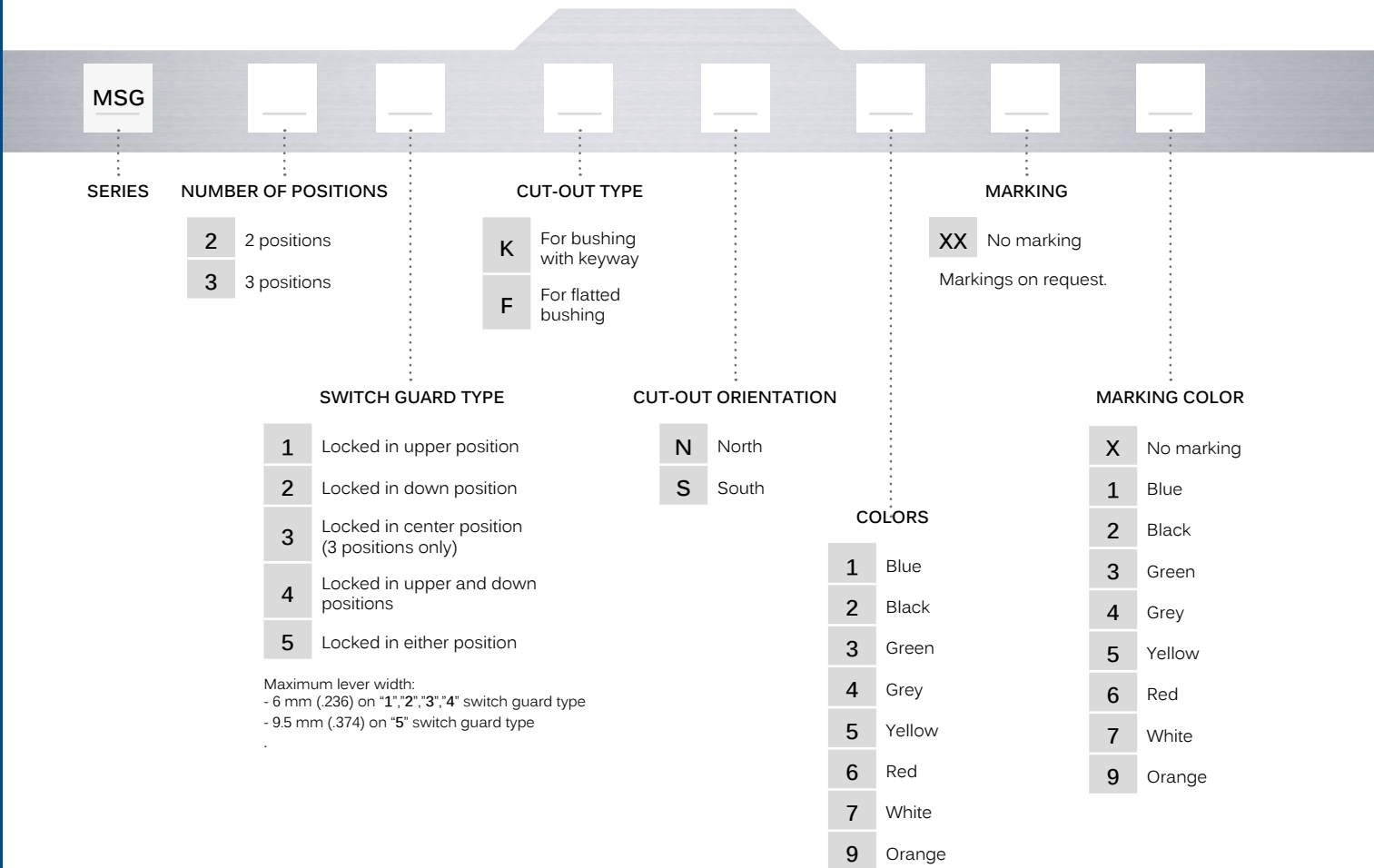

## ABOUT THIS SERIES

On the following pages, you will find successively basic part numbers and options in the same order as in above chart.



**Notice** : please note that not all combinations of above numbers are available. Refer to the following pages for further information.



**Mounting accessories** : supplied with the switch or to order separately (see "Hardware" section of website).

# MSG series

Rugged switch guards for switch series 12000 - 3500 - 600H - 6000

## DIMENSIONS



Note : Ø 1.80 mm holes for wiring a seal are standard on all models.

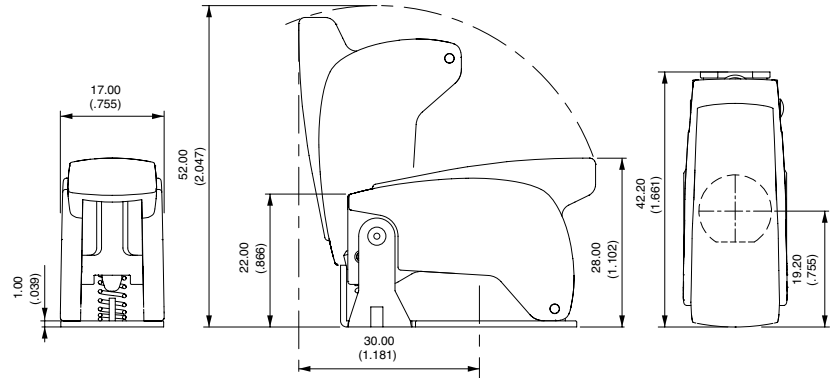

## NUMBER OF POSITIONS

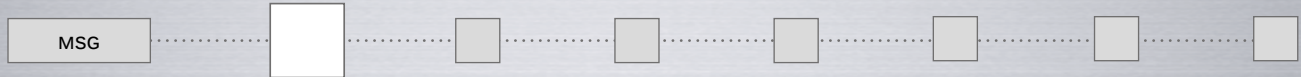

- 2 2 positions
- 3 3 positions

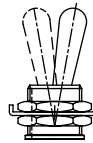

2



3

## SWITCH GUARD TYPE



- 1 Locked in upper position
- 2 Locked in down position
- 3 Locked in center position (3 positions only)
- 4 Locked in upper and down positions
- 5 Locked in either position

Maximum lever width:

- 6 mm (.236) on "1","2","3","4" switch guard type
- 9.5 mm (.374) on "5" switch guard type



1

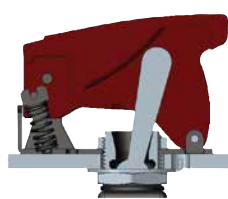

2

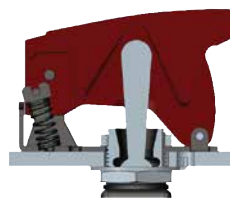

3

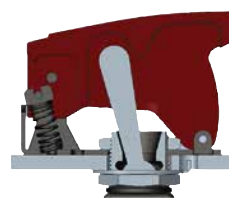

4

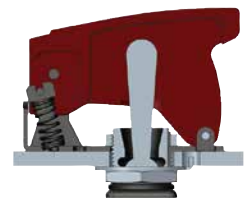

5

# MSG series

Rugged switch guards for switch series 12000 - 3500 - 600H - 6000

## CUT-OUT TYPE



- K For bushing with keyway
- F For flatted bushing



K



F

## CUT-OUT ORIENTATION

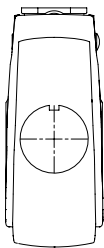

N

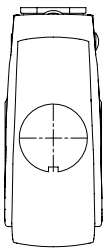

S

## COLORS

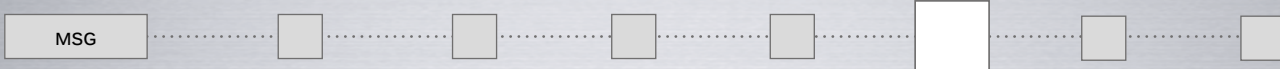

- 1 Blue
- 2 Black
- 3 Green
- 4 Grey
- 5 Yellow
- 6 Red
- 7 White
- 9 Orange



## MARKING



- XX No marking
- On request.

## MARKING COLOR

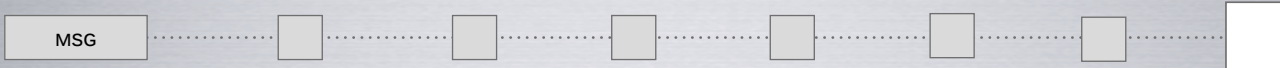

- |    |            |   |        |   |        |
|----|------------|---|--------|---|--------|
| XX | No marking | 3 | Green  | 6 | Red    |
| 1  | Blue       | 4 | Grey   | 7 | White  |
| 2  | Black      | 5 | Yellow | 9 | Orange |



Компания «ЭлектроПласт» предлагает заключение долгосрочных отношений при поставках импортных электронных компонентов на взаимовыгодных условиях!

Наши преимущества:

- Оперативные поставки широкого спектра электронных компонентов отечественного и импортного производства напрямую от производителей и с крупнейших мировых складов;
- Поставка более 17-ти миллионов наименований электронных компонентов;
- Поставка сложных, дефицитных, либо снятых с производства позиций;
- Оперативные сроки поставки под заказ (от 5 рабочих дней);
- Экспресс доставка в любую точку России;
- Техническая поддержка проекта, помощь в подборе аналогов, поставка прототипов;
- Система менеджмента качества сертифицирована по Международному стандарту ISO 9001;
- Лицензия ФСБ на осуществление работ с использованием сведений, составляющих государственную тайну;
- Поставка специализированных компонентов (Xilinx, Altera, Analog Devices, Intersil, Interpoint, Microsemi, Aeroflex, Peregrine, Syfer, Eurofarad, Texas Instrument, Miteq, Cobham, E2V, MA-COM, Hittite, Mini-Circuits, General Dynamics и др.);

Помимо этого, одним из направлений компании «ЭлектроПласт» является направление «Источники питания». Мы предлагаем Вам помощь Конструкторского отдела:

- Подбор оптимального решения, техническое обоснование при выборе компонента;
- Подбор аналогов;
- Консультации по применению компонента;
- Поставка образцов и прототипов;
- Техническая поддержка проекта;
- Защита от снятия компонента с производства.



#### Как с нами связаться

**Телефон:** 8 (812) 309 58 32 (многоканальный)

**Факс:** 8 (812) 320-02-42

**Электронная почта:** [org@eplast1.ru](mailto:org@eplast1.ru)

**Адрес:** 198099, г. Санкт-Петербург, ул. Калинина, дом 2, корпус 4, литера А.