

MSG series

Rugged switch guards for switch series 12000 - 3500 - 600H - 6000



DISTINCTIVE FEATURES

Robust
For harsh environments
Modern, patented design



GENERAL SPECIFICATIONS

- APEM SAS patented design
- Operating temperature : -40 °C to +85 °C (-40 °F to +185 °F)
- Storage temperature : -55 °C to +85 °C (-67 °F to +185 °F)
- Salt spray : IEC 60068-2-11, test KA, 96 hours
- Mechanical life : 20,000 cycles
- Switch guards are designed to prevent accidental lever operation on switches with \varnothing 11.9 (.468) or \varnothing 12 (.472) threaded bushing and lever length 17.5 (.688) outside bushing.
When the guard is raised, the lever can be operated freely.
When the guard is fully depressed, the lever is reset/locked in a stable position.
Note : For correct switch operation, the switch guard should be adjusted properly (see "Mounting" below).



MATERIALS

- Support plate : black stainless steel
- Cap : thermoset

APEM products may be recycled at end-of-life for the re-claiming of valuable metal components.



PANEL CUT-OUT

FOR BUSHING WITH KEYWAY

FOR FLATTED BUSHING

K

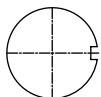

F

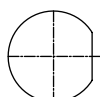

The company reserves the right to change specifications without notice.



MSG series

Rugged switch guards for switch series 12000 - 3500 - 600H - 6000

MOUNTING

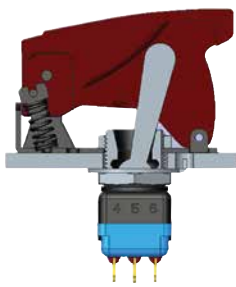

Standard



With K sealing option

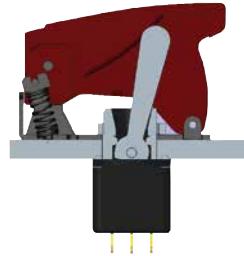

With X408 sealing option

BUILD YOUR PART NUMBER

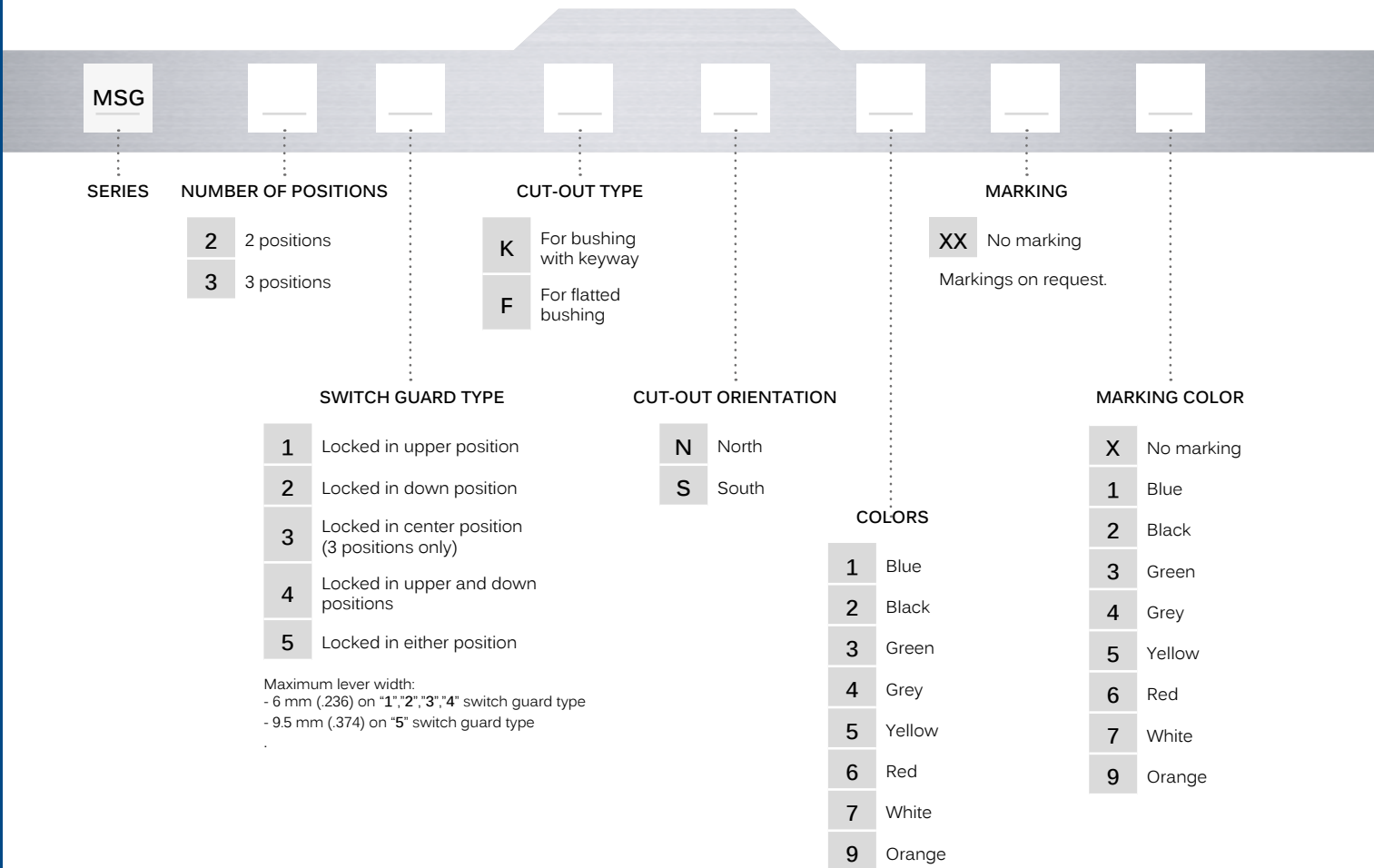

ABOUT THIS SERIES

On the following pages, you will find successively basic part numbers and options in the same order as in above chart.

- Notice** : please note that not all combinations of above numbers are available. Refer to the following pages for further information.
- Mounting accessories** : supplied with the switch or to order separately (see "Hardware" section of website).

MSG series

Rugged switch guards for switch series 12000 - 3500 - 600H - 6000

DIMENSIONS



Note : Ø 1.80 mm holes for wiring a seal are standard on all models.

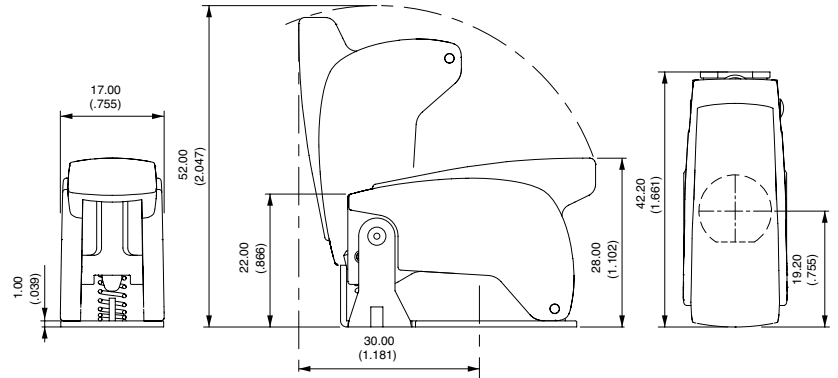

NUMBER OF POSITIONS

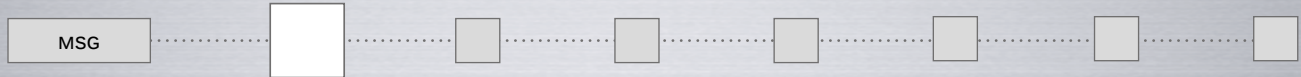

- 2 2 positions
- 3 3 positions

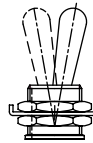

2



3

SWITCH GUARD TYPE



- 1 Locked in upper position
- 2 Locked in down position
- 3 Locked in center position (3 positions only)
- 4 Locked in upper and down positions
- 5 Locked in either position

Maximum lever width:

- 6 mm (.236) on "1","2","3","4" switch guard type
- 9.5 mm (.374) on "5" switch guard type



1

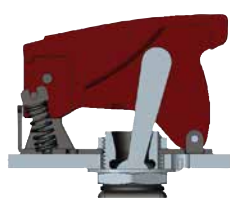

2

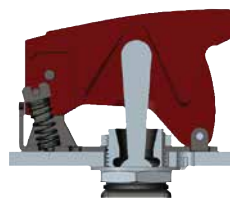

3

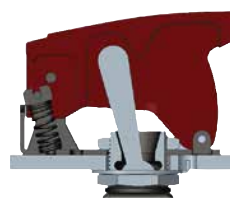

4

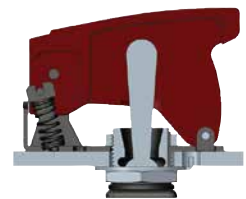

5

MSG series

Rugged switch guards for switch series 12000 - 3500 - 600H - 6000

CUT-OUT TYPE



- K For bushing with keyway
- F For flatted bushing

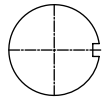

K

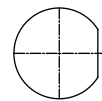

F

CUT-OUT ORIENTATION

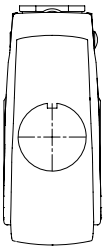
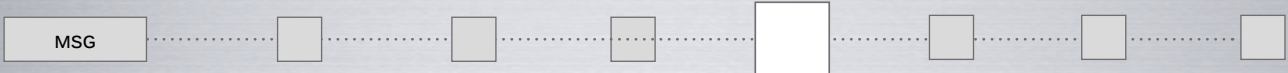

N

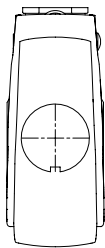

S

COLORS

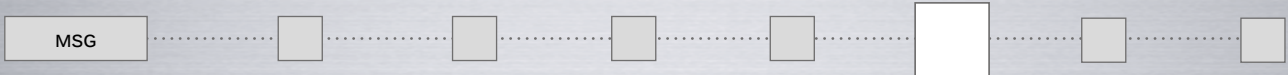

- 1 Blue
- 2 Black
- 3 Green
- 4 Grey
- 5 Yellow
- 6 Red
- 7 White
- 9 Orange



MARKING

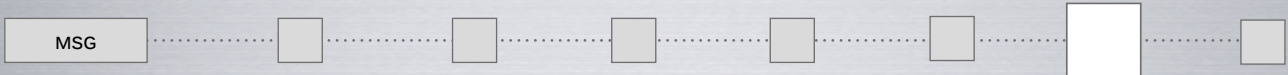

- XX No marking
- On request.

MARKING COLOR

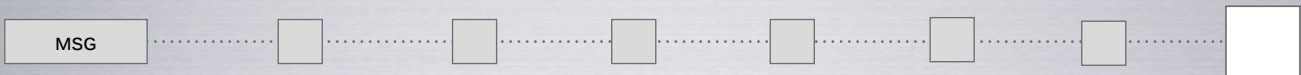

- | | | | | | |
|----|------------|---|--------|---|--------|
| XX | No marking | 3 | Green | 6 | Red |
| 1 | Blue | 4 | Grey | 7 | White |
| 2 | Black | 5 | Yellow | 9 | Orange |



Компания «ЭлектроПласт» предлагает заключение долгосрочных отношений при поставках импортных электронных компонентов на взаимовыгодных условиях!

Наши преимущества:

- Оперативные поставки широкого спектра электронных компонентов отечественного и импортного производства напрямую от производителей и с крупнейших мировых складов;
- Поставка более 17-ти миллионов наименований электронных компонентов;
- Поставка сложных, дефицитных, либо снятых с производства позиций;
- Оперативные сроки поставки под заказ (от 5 рабочих дней);
- Экспресс доставка в любую точку России;
- Техническая поддержка проекта, помощь в подборе аналогов, поставка прототипов;
- Система менеджмента качества сертифицирована по Международному стандарту ISO 9001;
- Лицензия ФСБ на осуществление работ с использованием сведений, составляющих государственную тайну;
- Поставка специализированных компонентов (Xilinx, Altera, Analog Devices, Intersil, Interpoint, Microsemi, Aeroflex, Peregrine, Syfer, Eurofarad, Texas Instrument, Miteq, Cobham, E2V, MA-COM, Hittite, Mini-Circuits, General Dynamics и др.);

Помимо этого, одним из направлений компании «ЭлектроПласт» является направление «Источники питания». Мы предлагаем Вам помощь Конструкторского отдела:

- Подбор оптимального решения, техническое обоснование при выборе компонента;
- Подбор аналогов;
- Консультации по применению компонента;
- Поставка образцов и прототипов;
- Техническая поддержка проекта;
- Защита от снятия компонента с производства.



Как с нами связаться

Телефон: 8 (812) 309 58 32 (многоканальный)

Факс: 8 (812) 320-02-42

Электронная почта: org@eplast1.ru

Адрес: 198099, г. Санкт-Петербург, ул. Калинина, дом 2, корпус 4, литера А.