



# 250ksps, +3V, 8-/4-Channel, 10-Bit ADCs with +2.5V Reference and Parallel Interface

## General Description

The MAX1061/MAX1063 low-power, 10-bit analog-to-digital converters (ADCs) feature a successive-approximation ADC, automatic power-down, fast wake-up (2 $\mu$ s), an on-chip clock, +2.5V internal reference, and a high-speed, byte-wide parallel interface. They operate with a single +3V analog supply and feature a V<sub>LOGIC</sub> pin that allows them to interface directly with a +1.8V to +3.6V digital supply.

Power consumption is only 5.7mW (V<sub>DD</sub> = V<sub>LOGIC</sub>) at the maximum sampling rate of 250ksps. Two software-selectable power-down modes enable the MAX1061/MAX1063 to be shut down between conversions; accessing the parallel interface returns them to normal operation. Powering down between conversions can cut supply current to under 10 $\mu$ A at reduced sampling rates.

Both devices offer software-configurable analog inputs for unipolar/bipolar and single-ended/pseudo-differential operation. In single-ended mode, the MAX1061 has eight input channels and the MAX1063 has four input channels (four and two input channels, respectively, when in pseudo-differential mode).

Excellent dynamic performance and low power, combined with ease of use and small package size, make these converters ideal for battery-powered and data-acquisition applications or for other circuits with demanding power consumption and space requirements.

The MAX1061 is available in a 28-pin QSOP package, while the MAX1063 is available in a 24-pin QSOP. For pin-compatible +5V, 10-bit versions, refer to the MAX1060/MAX1064 data sheet.

## Applications

Industrial Control Systems	Data Logging
Energy Management	Patient Monitoring
Data-Acquisition Systems	Touch Screens

## Ordering Information

PART	TEMP RANGE	PIN-PACKAGE	INL (LSB)
MAX1061ACEI+	0°C to +70°C	28 QSOP	$\pm 0.5$
MAX1061BCEI+	0°C to +70°C	28 QSOP	$\pm 1$
MAX1061AEEI+	-40°C to +85°C	28 QSOP	$\pm 0.5$
MAX1061BEEI+	-40°C to +85°C	28 QSOP	$\pm 1$

+Denotes a lead(Pb)-free/RoHS-compliant package.

Ordering Information continued at end of data sheet.

## Features

- ◆ 10-Bit Resolution,  $\pm 0.5$  LSB Linearity
- ◆ +3V Single-Supply Operation
- ◆ User-Adjustable Logic Level (+1.8V to +3.6V)
- ◆ Internal +2.5V Reference
- ◆ Software-Configurable, Analog Input Multiplexer
  - 8-Channel Single Ended/
  - 4-Channel Pseudo-Differential (MAX1061)
  - 4-Channel Single Ended/
  - 2-Channel Pseudo-Differential (MAX1063)
- ◆ Software-Configurable, Unipolar/Bipolar Inputs
- ◆ Low Power
  - 1.9mA (250ksps)
  - 1.0mA (100ksps)
  - 400 $\mu$ A (10ksps)
  - 2 $\mu$ A (Shutdown)
- ◆ Internal 3MHz Full-Power Bandwidth Track/Hold
- ◆ Byte-Wide Parallel (8 + 2) Interface
- ◆ Small Footprint: 28-Pin QSOP (MAX1061)  
24-Pin QSOP (MAX1063)

## Pin Configurations

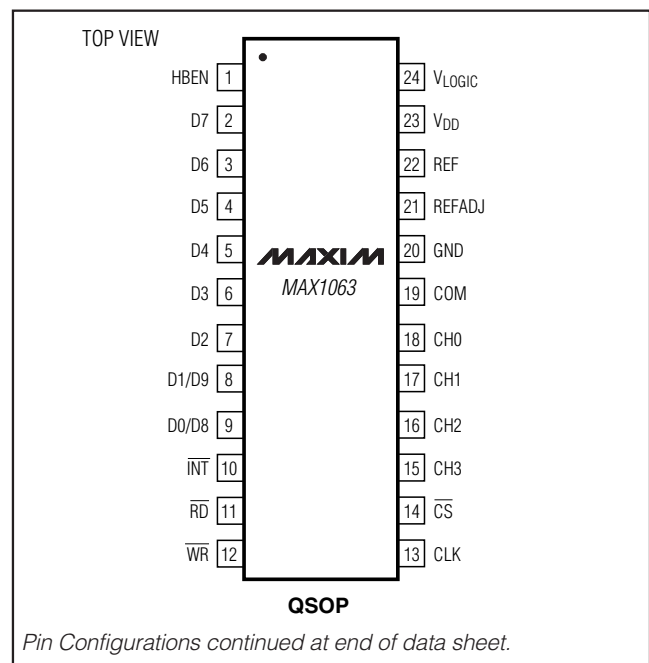

Typical Operating Circuits appear at end of data sheet.

MAX1061/MAX1063



# 250ksps, +3V, 8-/4-Channel, 10-Bit ADCs with +2.5V Reference and Parallel Interface

## ABSOLUTE MAXIMUM RATINGS

V <sub>DD</sub> to GND	-0.3V to +6V
V <sub>LOGIC</sub> to GND	-0.3V to +6V
CH0–CH7, COM to GND	-0.3V to (V <sub>DD</sub> + 0.3V)
REF, REFADJ to GND	-0.3V to (V <sub>DD</sub> + 0.3V)
Digital Inputs to GND	-0.3V to +6V
Digital Outputs (D0–D9, INT) to GND	-0.3V to (V <sub>LOGIC</sub> + 0.3V)

Continuous Power Dissipation (T <sub>A</sub> = +70°C)	
24-Pin QSOP (derate 9.5mW/°C above +70°C)	762mW
28-Pin QSOP (derate 8.0mW/°C above +70°C)	667mW
Operating Temperature Ranges	
MAX1061_C_/MAX1063_C_	0°C to +70°C
MAX1061_E_/MAX1063_E_	-40°C to +85°C
Storage Temperature Range	-65°C to +150°C
Lead Temperature (soldering, 10s)	+300°C

Stresses beyond those listed under "Absolute Maximum Ratings" may cause permanent damage to the device. These are stress ratings only, and functional operation of the device at these or any other conditions beyond those indicated in the operational sections of the specifications is not implied. Exposure to absolute maximum rating conditions for extended periods may affect device reliability.

## ELECTRICAL CHARACTERISTICS

(V<sub>DD</sub> = V<sub>LOGIC</sub> = +2.7V to +3.6V, COM = GND, REFADJ = V<sub>DD</sub>, V<sub>REF</sub> = +2.5V, 4.7μF capacitor at REF pin, f<sub>CLK</sub> = 4.8MHz (50% duty cycle), T<sub>A</sub> = T<sub>MIN</sub> to T<sub>MAX</sub>, unless otherwise noted. Typical values are at T<sub>A</sub> = +25°C.)

PARAMETER	SYMBOL	CONDITIONS	MIN	TYP	MAX	UNITS
<b>DC ACCURACY</b> (Note 1)						
Resolution	RES		10			Bits
Relative Accuracy (Note 2)	INL	MAX106_A			±0.5	LSB
		MAX106_B			±1	
Differential Nonlinearity	DNL	No missing codes over temperature			±1	LSB
Offset Error					±2	LSB
Gain Error		(Note 3)			±2	LSB
Gain Temperature Coefficient				±2.0		ppm/°C
Channel-to-Channel Offset Matching				±0.1		LSB
<b>DYNAMIC SPECIFICATIONS</b> (f <sub>IN(sine wave)</sub> = 50kHz, V <sub>IN</sub> = 2.5V <sub>P-P</sub> , 250ksps, external f <sub>CLK</sub> = 4.8MHz, bipolar input mode)						
Signal-to-Noise Plus Distortion	SINAD			60		dB
Total Harmonic Distortion (Including 5th-Order Harmonic)	THD			-72		dB
Spurious-Free Dynamic Range	SFDR			72		dB
Intermodulation Distortion	IMD	f <sub>IN1</sub> = 49kHz, f <sub>IN2</sub> = 52kHz		76		dB
Channel-to-Channel Crosstalk		f <sub>IN</sub> = 125kHz, V <sub>IN</sub> = 2.5V <sub>P-P</sub> (Note 4)		-78		dB
Full-Linear Bandwidth		SINAD > 56dB		250		kHz
Full-Power Bandwidth		-3dB rolloff		3		MHz
<b>CONVERSION RATE</b>						
Conversion Time (Note 5)	t <sub>CONV</sub>	External clock mode	3.3			μs
		External acquisition/internal clock mode	2.5	3.0	3.5	
		Internal acquisition/internal clock mode	3.2	3.6	4.1	
Track/Hold Acquisition Time	t <sub>ACQ</sub>				625	ns
Aperture Delay		External acquisition or external clock mode		50		ns
Aperture Jitter		External acquisition or external clock mode		<50		ps
		Internal acquisition/internal clock mode		<200		
External Clock Frequency	f <sub>CLK</sub>		0.1		4.8	MHz
Duty Cycle			30		70	%

# 250ksps, +3V, 8-/4-Channel, 10-Bit ADCs with +2.5V Reference and Parallel Interface

MAX1061/MAX1063

## ELECTRICAL CHARACTERISTICS (continued)

( $V_{DD} = V_{LOGIC} = +2.7V$  to  $+3.6V$ ,  $COM = GND$ ,  $REFADJ = V_{DD}$ ,  $V_{REF} = +2.5V$ ,  $4.7\mu F$  capacitor at REF pin,  $f_{CLK} = 4.8MHz$  (50% duty cycle),  $T_A = T_{MIN}$  to  $T_{MAX}$ , unless otherwise noted. Typical values are at  $T_A = +25^\circ C$ .)

PARAMETER	SYMBOL	CONDITIONS	MIN	TYP	MAX	UNITS
<b>ANALOG INPUTS</b>						
Analog Input Voltage Range Single Ended and Differential (Note 6)	$V_{IN}$	Unipolar, $V_{COM} = 0$	0		$V_{REF}$	V
		Bipolar, $V_{COM} = V_{REF} / 2$	$-V_{REF}/2$		$+V_{REF}/2$	
Multiplexer Leakage Current		On-/off-leakage current, $V_{IN} = 0$ or $V_{DD}$		$\pm 0.01$	$\pm 1$	$\mu A$
Input Capacitance	$C_{IN}$			12		pF
<b>INTERNAL REFERENCE</b>						
REF Output Voltage			2.49	2.5	2.51	V
REF Short-Circuit Current				15		mA
REF Temperature Coefficient	$TC_{REF}$	$T_A = 0^\circ C$ to $+70^\circ C$		$\pm 20$		ppm/ $^\circ C$
REFADJ Input Range		For small adjustments		$\pm 100$		mV
REFADJ High Threshold		To power down the internal reference	$V_{DD} - 1.0$			V
Load Regulation		0 to 0.5mA output load (Note 7)		0.2		mV/mA
Capacitive Bypass at REFADJ				0.01	1	$\mu F$
Capacitive Bypass at REF			4.7		10	$\mu F$
<b>EXTERNAL REFERENCE AT REF</b>						
REF Input Voltage Range	$V_{REF}$		1.0		$V_{DD} + 50mV$	V
REF Input Current	$I_{REF}$	$V_{REF} = 2.5V$ , $f_{SAMPLE} = 250ksps$		200	300	$\mu A$
		Shutdown mode			2	
<b>DIGITAL INPUTS AND OUTPUTS</b>						
Input High Voltage	$V_{IH}$	$V_{LOGIC} = 2.7V$	2.0			V
		$V_{LOGIC} = 1.8V$	1.5			
Input Low Voltage	$V_{IL}$	$V_{LOGIC} = 2.7V$			0.8	V
		$V_{LOGIC} = 1.8V$			0.5	
Input Hysteresis	$V_{HYS}$			200		mV
Input Leakage Current	$I_{IN}$	$V_{IN} = 0$ or $V_{DD}$		$\pm 0.1$	$\pm 1$	$\mu A$
Input Capacitance	$C_{IN}$			15		pF
Output Low Voltage	$V_{OL}$	$I_{SINK} = 1.6mA$			0.4	V
Output High Voltage	$V_{OH}$	$I_{SOURCE} = 1mA$	$V_{LOGIC} - 0.5$			V
Tri-State Leakage Current	$I_{LEAKAGE}$	$\overline{CS} = V_{DD}$		$\pm 0.1$	$\pm 1$	$\mu A$
Tri-State Output Capacitance	$C_{OUT}$	$\overline{CS} = V_{DD}$		15		pF

# 250ksps, +3V, 8-/4-Channel, 10-Bit ADCs with +2.5V Reference and Parallel Interface

## ELECTRICAL CHARACTERISTICS (continued)

( $V_{DD} = V_{LOGIC} = +2.7V$  to  $+3.6V$ ,  $COM = GND$ ,  $REFADJ = V_{DD}$ ,  $V_{REF} = +2.5V$ ,  $4.7\mu F$  capacitor at REF pin,  $f_{CLK} = 4.8MHz$  (50% duty cycle),  $T_A = T_{MIN}$  to  $T_{MAX}$ , unless otherwise noted. Typical values are at  $T_A = +25^\circ C$ .)

PARAMETER	SYMBOL	CONDITIONS		MIN	TYP	MAX	UNITS
<b>POWER REQUIREMENTS</b>							
Analog Supply Voltage	$V_{DD}$			2.7		3.6	V
Digital Supply Voltage	$V_{LOGIC}$			1.8	$V_{DD} + 0.3$		V
Positive Supply Current	$I_{DD}$	Operating mode, $f_{SAMPLE} = 250ksps$	Internal reference		2.3	2.6	mA
			External reference		1.9	2.3	
		Standby mode	Internal reference		0.9	1.2	
			External reference		0.5	0.8	
Shutdown mode				2	10	$\mu A$	
$V_{LOGIC}$ Current	$I_{LOGIC}$	$C_L = 20pF$	$f_{SAMPLE} = 250ksps$			150	$\mu A$
			Not converting		2	10	
Power-Supply Rejection	PSR	$V_{DD} = 3V \pm 10\%$ , full-scale input			$\pm 0.4$	$\pm 0.9$	mV

## TIMING CHARACTERISTICS

( $V_{DD} = V_{LOGIC} = +2.7V$  to  $+3.6V$ ,  $COM = GND$ ,  $REFADJ = V_{DD}$ ,  $V_{REF} = +2.5V$ ,  $4.7\mu F$  capacitor at REF pin,  $f_{CLK} = 4.8MHz$  (50% duty cycle),  $T_A = T_{MIN}$  to  $T_{MAX}$ , unless otherwise noted. Typical values are at  $T_A = +25^\circ C$ .)

PARAMETER	SYMBOL	CONDITIONS	MIN	TYP	MAX	UNITS
CLK Period	$t_{CP}$		208			ns
CLK Pulse Width High	$t_{CH}$		40			ns
CLK Pulse Width Low	$t_{CL}$		40			ns
Data Valid to $\overline{WR}$ Rise Time	$t_{DS}$		40			ns
$\overline{WR}$ Rise to Data Valid Hold Time	$t_{DH}$		0			ns
$\overline{WR}$ to CLK Fall Setup Time	$t_{CWS}$		40			ns
CLK Fall to $\overline{WR}$ Hold Time	$t_{CWH}$		40			ns
$\overline{CS}$ to CLK or $\overline{WR}$ Setup Time	$t_{CSWS}$		60			ns
CLK or $\overline{WR}$ to $\overline{CS}$ Hold Time	$t_{CSWH}$		0			ns
$\overline{CS}$ Pulse Width	$t_{CS}$		100			ns
$\overline{WR}$ Pulse Width	$t_{WR}$	(Note 8)	60			ns
$\overline{CS}$ Rise to Output Disable	$t_{TC}$	$C_{LOAD} = 20pF$ , Figure 1	20		100	ns

# 250ksps, +3V, 8-/4-Channel, 10-Bit ADCs with +2.5V Reference and Parallel Interface

MAX1061/MAX1063

## TIMING CHARACTERISTICS (continued)

( $V_{DD} = V_{LOGIC} = +2.7V$  to  $+3.6V$ ,  $COM = GND$ ,  $REFADJ = V_{DD}$ ,  $V_{REF} = +2.5V$ ,  $4.7\mu F$  capacitor at REF pin,  $f_{CLK} = 4.8MHz$  (50% duty cycle),  $T_A = T_{MIN}$  to  $T_{MAX}$ , unless otherwise noted. Typical values are at  $T_A = +25^\circ C$ .)

PARAMETER	SYMBOL	CONDITIONS	MIN	TYP	MAX	UNITS
$\overline{RD}$ Rise to Output Disable	$t_{TR}$	$C_{LOAD} = 20pF$ , Figure 1	20		70	ns
$\overline{RD}$ Fall to Output Data Valid	$t_{DO}$	$C_{LOAD} = 20pF$ , Figure 1	20		70	ns
HBEN to Output Data Valid	$t_{DO1}$	$C_{LOAD} = 20pF$ , Figure 1	20		110	ns
$\overline{RD}$ Fall to $\overline{INT}$ High Delay	$t_{INT1}$	$C_{LOAD} = 20pF$ , Figure 1			100	ns
$\overline{CS}$ Fall to Output Data Valid	$t_{DO2}$	$C_{LOAD} = 20pF$ , Figure 1			110	ns

- Note 1:** Tested at  $V_{DD} = +3V$ ,  $COM = GND$ , unipolar single-ended input mode.
- Note 2:** Relative accuracy is the deviation of the analog value at any code from its theoretical value after offset and gain errors have been removed.
- Note 3:** Offset nulled.
- Note 4:** On channel is grounded; sine wave applied to off channels.
- Note 5:** Conversion time is defined as the number of clock cycles times the clock period; clock has 50% duty cycle.
- Note 6:** Input voltage range referenced to negative input. The absolute range for the analog inputs is from GND to  $V_{DD}$ .
- Note 7:** External load should not change during conversion for specified accuracy.
- Note 8:** When bit 5 is set low for internal acquisition,  $\overline{WR}$  must not return low until after the first falling clock edge of the conversion.

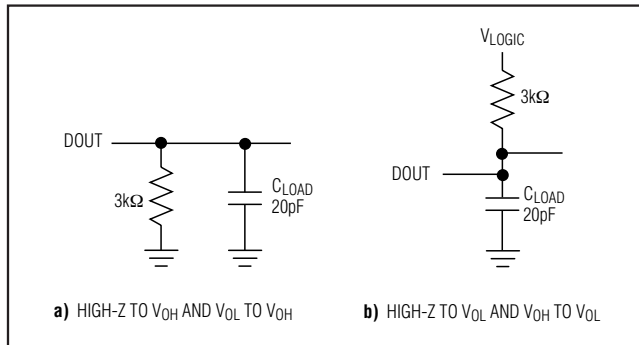

Figure 1. Load Circuits for Enable/Disable Times

# 250kps, +3V, 8-/4-Channel, 10-Bit ADCs with +2.5V Reference and Parallel Interface

## Typical Operating Characteristics

( $V_{DD} = V_{LOGIC} = +3V$ ,  $V_{REF} = +2.500V$ ,  $f_{CLK} = 4.8MHz$ ,  $C_L = 20pF$ ,  $T_A = +25^\circ C$ , unless otherwise noted.)

**INTEGRAL NONLINEARITY vs. OUTPUT CODE**

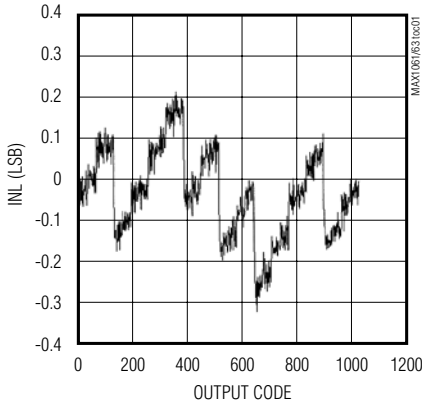

**DIFFERENTIAL NONLINEARITY vs. OUTPUT CODE**

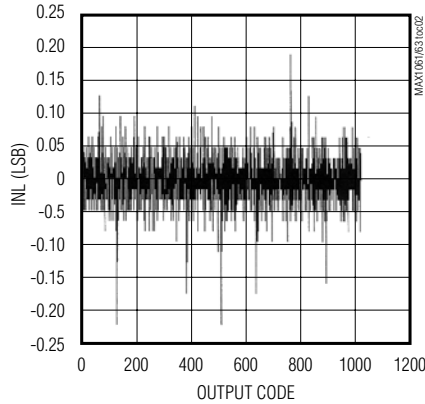

**SUPPLY CURRENT vs. SAMPLE FREQUENCY**

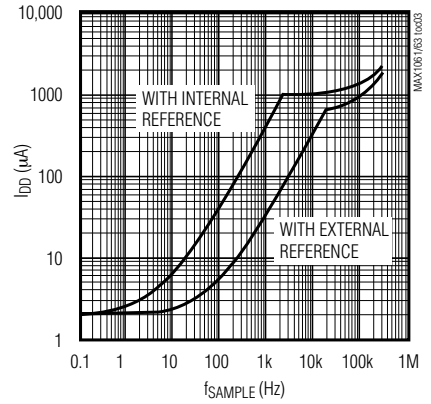

**SUPPLY CURRENT vs. SUPPLY VOLTAGE**

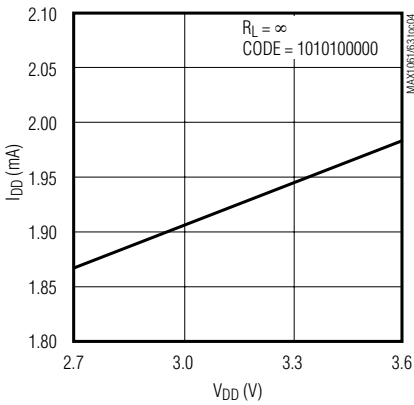

**SUPPLY CURRENT vs. TEMPERATURE**

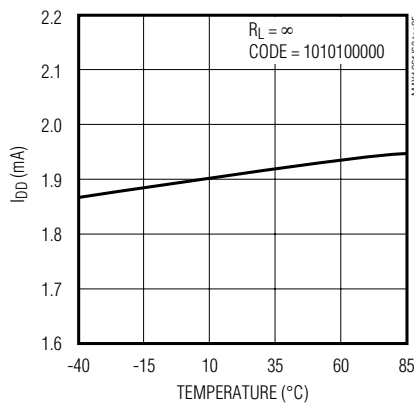

**STANDBY CURRENT vs. SUPPLY VOLTAGE**

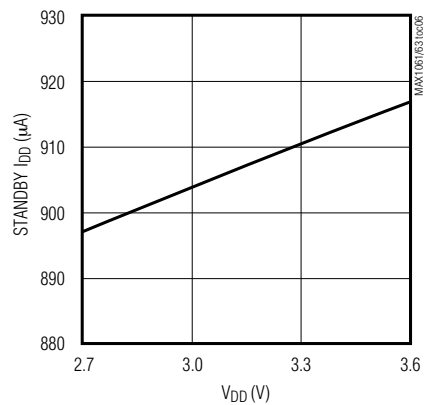

**STANDBY CURRENT vs. TEMPERATURE**

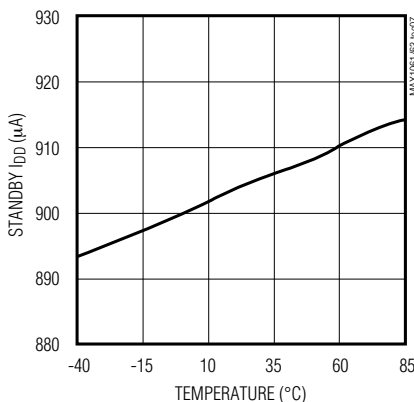

**POWER-DOWN CURRENT vs. SUPPLY VOLTAGE**

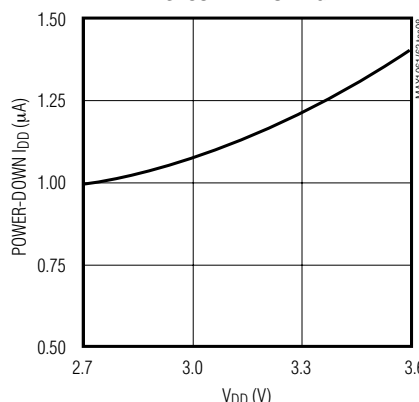

**POWER-DOWN CURRENT vs. TEMPERATURE**

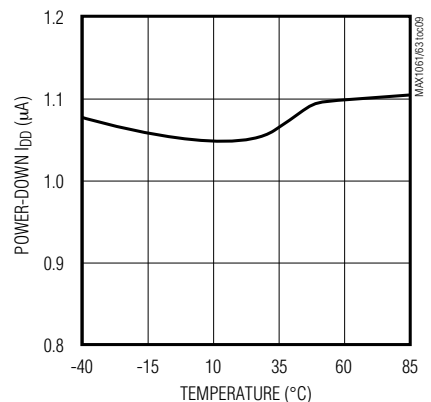

# 250ksps, +3V, 8-/4-Channel, 10-Bit ADCs with +2.5V Reference and Parallel Interface

## Typical Operating Characteristics (continued)

( $V_{DD} = V_{LOGIC} = +3V$ ,  $V_{REF} = +2.500V$ ,  $f_{CLK} = 4.8MHz$ ,  $C_L = 20pF$ ,  $T_A = +25^\circ C$ , unless otherwise noted.)

MAX1061/MAX1063

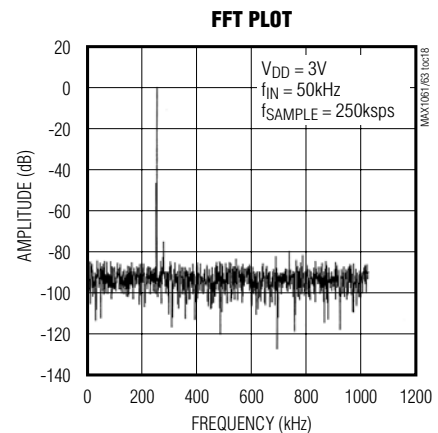
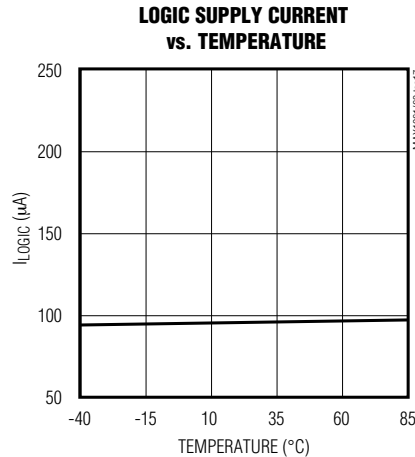
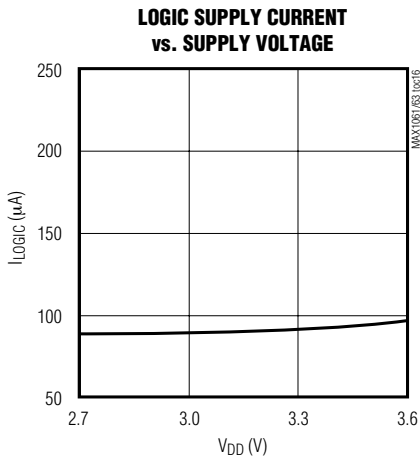
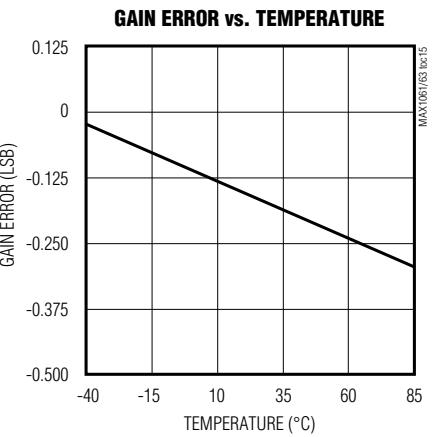
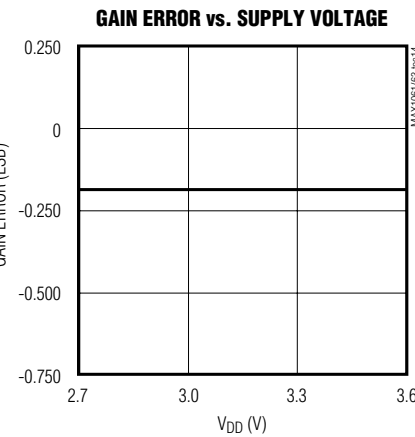
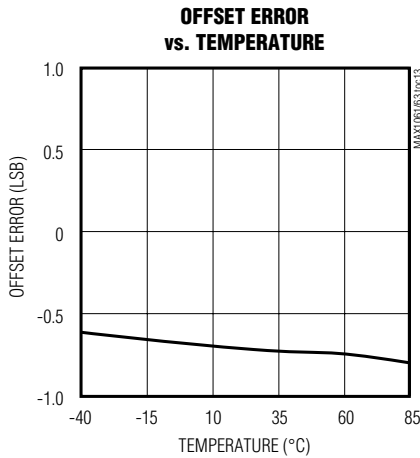
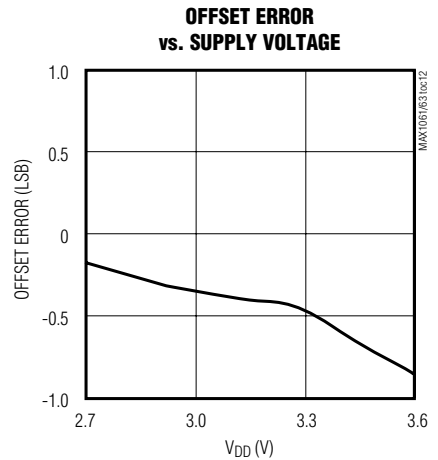
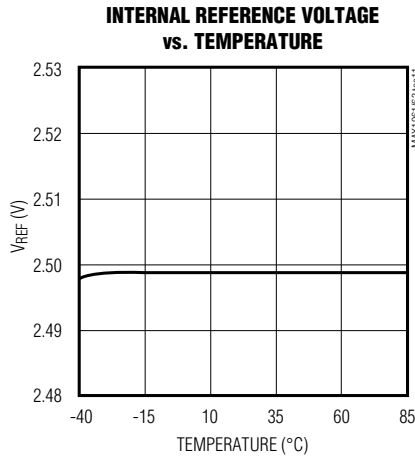
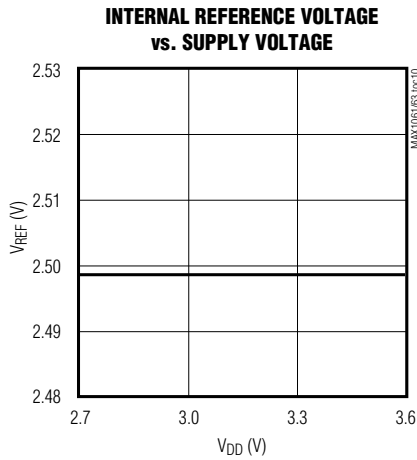

# 250ksps, +3V, 8-/4-Channel, 10-Bit ADCs with +2.5V Reference and Parallel Interface

## Pin Description

PIN		NAME	FUNCTION
MAX1061	MAX1063		
1	1	HBEN	High Byte Enable. Used to multiplex the 10-bit conversion result: 1: 2 MSBs are multiplexed on the data bus. 0: 8 LSBs are available on the data bus.
2	2	D7	Tri-State Digital I/O Line (D7)
3	3	D6	Tri-State Digital I/O Line (D6)
4	4	D5	Tri-State Digital I/O Line (D5)
5	5	D4	Tri-State Digital I/O Line (D4)
6	6	D3	Tri-State Digital I/O Line (D3)
7	7	D2	Tri-State Digital I/O Line (D2)
8	8	D1/D9	Tri-State Digital I/O Line (D1, HBEN = 0; D9, HBEN = 1)
9	9	D0/D8	Tri-State Digital I/O Line (D0, HBEN = 0; D8, HBEN = 1)
10	10	$\overline{\text{INT}}$	$\overline{\text{INT}}$ goes low when the conversion is complete and the output data is ready.
11	11	$\overline{\text{RD}}$	Active-Low Read Select. If $\overline{\text{CS}}$ is low, a falling edge on $\overline{\text{RD}}$ enables the read operation on the data bus.
12	12	$\overline{\text{WR}}$	Active-Low Write Select. When $\overline{\text{CS}}$ is low in internal acquisition mode, a rising edge on $\overline{\text{WR}}$ latches in configuration data and starts an acquisition plus a conversion cycle. When $\overline{\text{CS}}$ is low in external acquisition mode, the first rising edge on $\overline{\text{WR}}$ ends acquisition and starts a conversion.
13	13	CLK	Clock Input. In external clock mode, drive CLK with a TTL-/CMOS-compatible clock. In internal clock mode, connect this pin to either $V_{\text{DD}}$ or GND.
14	14	$\overline{\text{CS}}$	Active-Low Chip Select. When $\overline{\text{CS}}$ is high, digital outputs (D7–D0) are high impedance.
15	—	CH7	Analog Input Channel 7
16	—	CH6	Analog Input Channel 6
17	—	CH5	Analog Input Channel 5
18	—	CH4	Analog Input Channel 4
19	15	CH3	Analog Input Channel 3
20	16	CH2	Analog Input Channel 2
21	17	CH1	Analog Input Channel 1
22	18	CH0	Analog Input Channel 0
23	19	COM	Ground Reference for Analog Inputs. Sets zero-code voltage in single-ended mode and must be stable to $\pm 0.5$ LSB during conversion.
24	20	GND	Analog and Digital Ground
25	21	REFADJ	Bandgap Reference Output/Bandgap Reference Buffer Input. Bypass to GND with a $0.01\mu\text{F}$ capacitor. When using an external reference, connect REFADJ to $V_{\text{DD}}$ to disable the internal bandgap reference.
26	22	REF	Bandgap Reference Buffer Output/External Reference Input. Add a $4.7\mu\text{F}$ capacitor to GND when using the internal reference.
27	23	$V_{\text{DD}}$	Analog +5V Power Supply. Bypass with a $0.1\mu\text{F}$ capacitor to GND.
28	24	$V_{\text{LOGIC}}$	Digital Power Supply. $V_{\text{LOGIC}}$ powers the digital outputs of the data converter and can range from +1.8V to ( $V_{\text{DD}}$ + 300mV).





# 250ksp/s, +3V, 8-/4-Channel, 10-Bit ADCs with +2.5V Reference and Parallel Interface

## Track/Hold

The MAX1061/MAX1063 T/H stage enters its tracking mode on the rising edge of  $\overline{WR}$ . In external acquisition mode, the part enters its hold mode on the next rising edge of  $\overline{WR}$ . In internal acquisition mode, the part enters its hold mode on the fourth falling edge of clock after writing the control byte. Note that, in internal clock mode, this occurs approximately  $1\mu\text{s}$  after writing the control byte. In single-ended operation,  $\text{IN-}$  is connected to COM and the converter samples the positive (+) input. In pseudo-differential operation,  $\text{IN-}$  connects to the negative input (-), and the difference of  $|(IN+) - (IN-)|$  is sampled. At the beginning of the next conversion, the positive input connects back to  $\text{IN+}$  and  $\text{C}_{\text{HOLD}}$  charges to the input signal.

The time required for the T/H stage to acquire an input signal depends on how quickly its input capacitance is charged. If the input signal's source impedance is high, the acquisition time lengthens, and more time must be allowed between conversions. The acquisition time,  $t_{\text{ACQ}}$ , is the maximum time the device takes to acquire the signal and is also the minimum time required for the signal to be acquired. Calculate this with the following equation:

$$t_{\text{ACQ}} = 7(R_S + R_{\text{IN}})C_{\text{IN}}$$

where  $R_S$  is the source impedance of the input signal,  $R_{\text{IN}}$  ( $800\Omega$ ) is the input resistance, and  $C_{\text{IN}}$  ( $12\text{pF}$ ) is the ADC's input capacitance. Source impedances below  $3\text{k}\Omega$  have no significant impact on the MAX1061/MAX1063s' AC performance.

Higher source impedances can be used if a  $0.01\mu\text{F}$  capacitor is connected to the individual analog inputs. Together with the input impedance, this capacitor forms an RC filter, limiting the ADC's signal bandwidth.

## Input Bandwidth

The MAX1061/MAX1063 T/H stage offers a 250kHz full-linear and a 3MHz full-power bandwidth, enabling these parts to use undersampling techniques to digitize high-speed transients and measure periodic signals with bandwidths exceeding the ADC's sampling rate. To avoid high-frequency signals being aliased into the frequency band of interest, anti-alias filtering is recommended.

## Starting a Conversion

Initiate a conversion by writing a control byte that selects the multiplexer channel and configures the MAX1061/MAX1063 for either unipolar or bipolar operation. A write pulse ( $\overline{WR} + \overline{CS}$ ) can either start an acquisition interval or initiate a combined acquisition plus

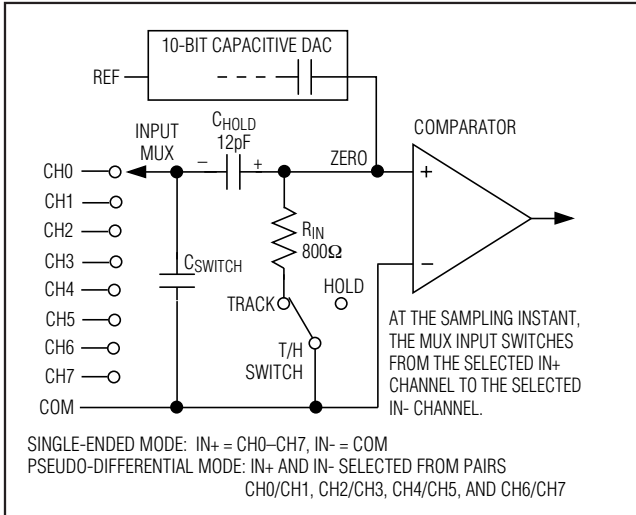

Figure 3a. MAX1061 Simplified Input Structure

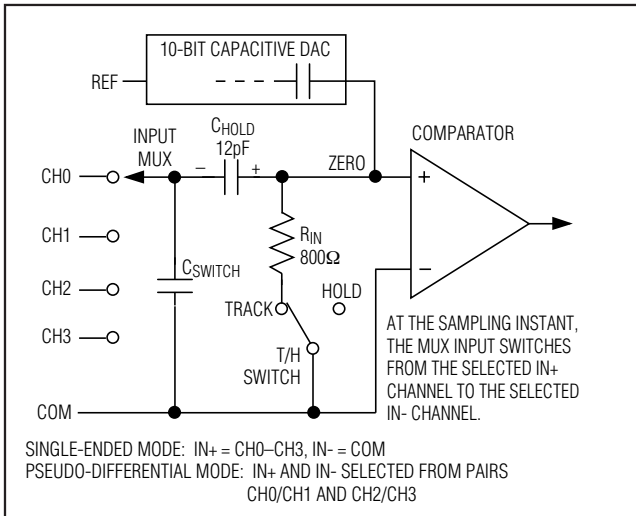

Figure 3b. MAX1063 Simplified Input Structure

## Analog Input Protection

Internal protection diodes, which clamp the analog input to  $V_{\text{DD}}$  and GND, allow each input channel to swing within  $(\text{GND} - 300\text{mV})$  to  $(V_{\text{DD}} + 300\text{mV})$  without damage. However, for accurate conversions near full scale, both inputs must not exceed  $(V_{\text{DD}} + 50\text{mV})$  or be less than  $(\text{GND} - 50\text{mV})$ .

If an off-channel analog input voltage exceeds the supplies by more than 50mV, limit the forward-bias input current to 4mA.

## 250ksps, +3V, 8-/4-Channel, 10-Bit ADCs with +2.5V Reference and Parallel Interface

conversion. The sampling interval occurs at the end of the acquisition interval. The ACQMOD (acquisition mode) bit in the input control byte (Table 1) offers two options for acquiring the signal: an internal and an external acquisition. The conversion period lasts for 13 clock cycles in either the internal or external clock or acquisition mode. Writing a new control byte during a conversion cycle aborts the conversion and starts a new acquisition interval.

### Internal Acquisition

Select internal acquisition by writing the control byte with the ACQMOD bit cleared (ACQMOD = 0). This causes the write pulse to initiate an acquisition interval whose duration is internally timed. Conversion starts when this acquisition interval ends (three external cycles or approximately 1 $\mu$ s in internal clock mode) (Figure 4). Note that, when the internal acquisition is combined with the internal clock, the aperture jitter can be as high as 200ps. Internal clock users wishing to achieve the 50ps jitter specification should always use external acquisition mode.

### External Acquisition

Use external acquisition mode for precise control of the sampling aperture and/or dependent control of acquisition and conversion times. The user controls acquisition and start of conversion with two separate write pulses. The first pulse, written with ACQMOD = 1, starts an acquisition interval of indeterminate length. The second write pulse, written with ACQMOD = 0, terminates acquisition and starts conversion on  $\overline{WR}$ 's rising edge (Figure 5).

The address bits for the input multiplexer must have the same values on the first and second write pulse. Power-down mode bits (PD0, PD1) can assume new values on the second write pulse (see the *Power-Down Modes* section). Changing other bits in the control byte corrupts the conversion.

### Reading a Conversion

A standard interrupt signal,  $\overline{INT}$ , is provided to allow the MAX1061/MAX1063 to flag the  $\mu$ P when the conversion has ended and a valid result is available.  $\overline{INT}$  goes low when the conversion is complete and the output data is ready (Figures 4 and 5). It returns high on the first read cycle or if a new control byte is written.

**Table 1. Control Byte Functional Description**

BIT	NAME	FUNCTION
D7, D6	PD1, PD0	PD1 and PD0 select the various clock and power-down modes.
		0 0 Full power-down mode. Clock mode is unaffected.
		0 1 Standby power-down mode. Clock mode is unaffected.
		1 0 Normal operation mode. Internal clock mode selected.
	1 1 Normal operation mode. External clock mode selected.	
D5	ACQMOD	ACQMOD = 0: Internal acquisition mode ACQMOD = 1: External acquisition mode
D4	SGL/ $\overline{DIF}$	SGL/ $\overline{DIF}$ = 0: Pseudo-differential analog input mode SGL/ $\overline{DIF}$ = 1: Single-ended analog input mode In single-ended mode, input signals are referred to COM. In pseudo-differential mode, the voltage difference between two channels is measured (Tables 2 and 3).
D3	UNI/ $\overline{BIP}$	UNI/ $\overline{BIP}$ = 0: Bipolar mode UNI/ $\overline{BIP}$ = 1: Unipolar mode In unipolar mode, an analog input signal from 0 to $V_{REF}$ can be converted; in bipolar mode, the signal can range from $-V_{REF}/2$ to $+V_{REF}/2$ .
D2, D1, D0	A2, A1, A0	Address bits A2, A1, A0 select which of the 8/4 (MAX1061/MAX1063) channels are to be converted (Tables 3 and 4).

# 250ksp/s, +3V, 8-/4-Channel, 10-Bit ADCs with +2.5V Reference and Parallel Interface

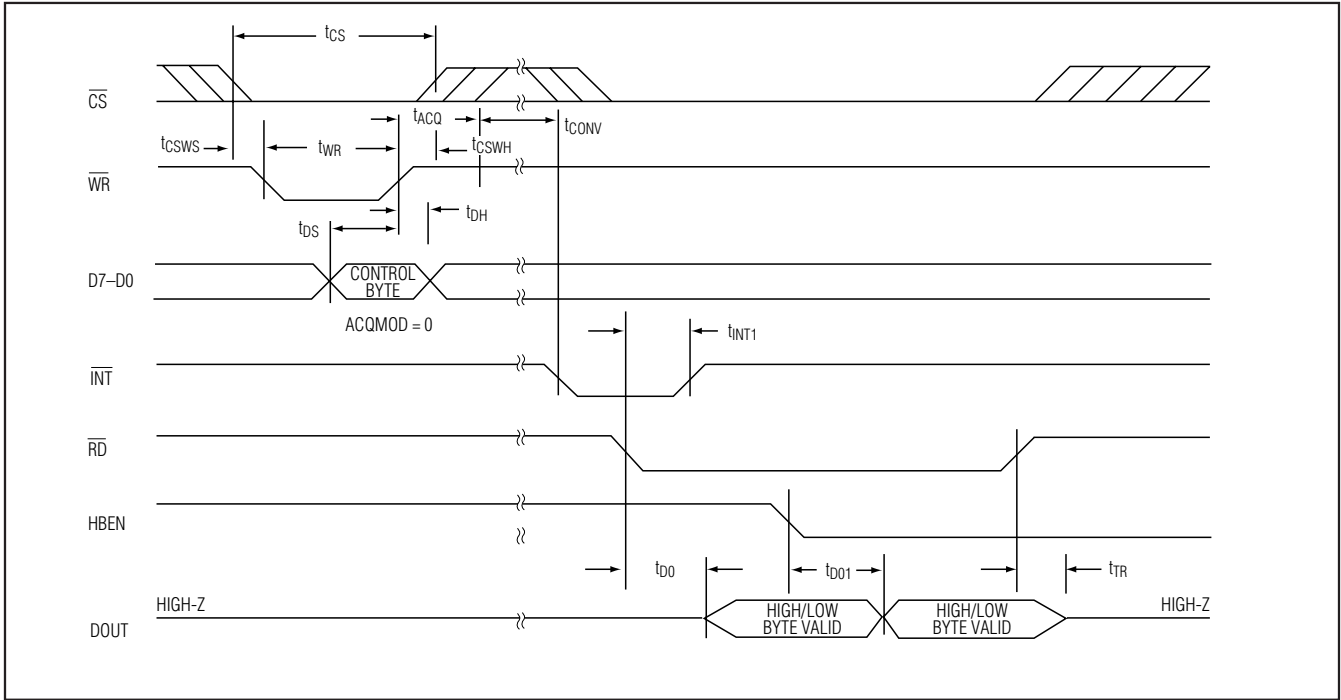

Figure 4. Conversion Timing Using Internal Acquisition Mode

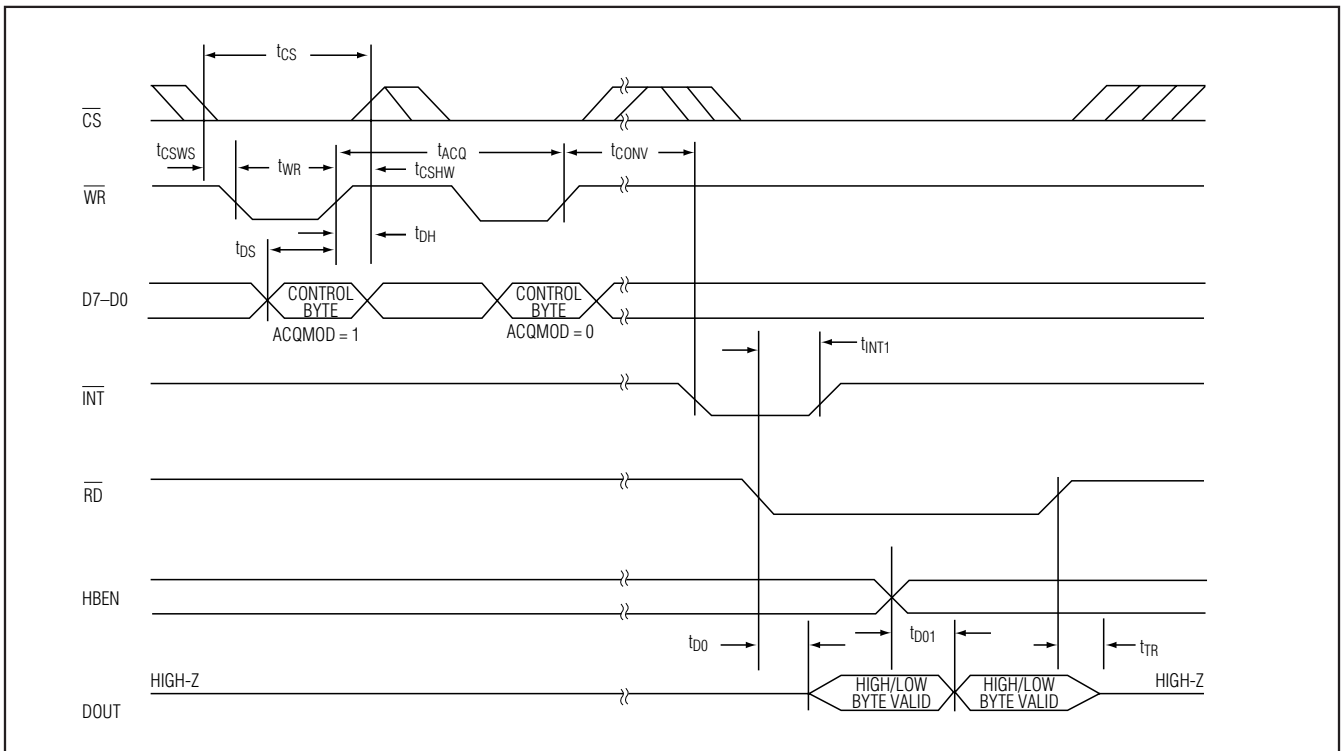

Figure 5. Conversion Timing Using External Acquisition Mode

# 250ksps, +3V, 8-/4-Channel, 10-Bit ADCs with +2.5V Reference and Parallel Interface

## Selecting Clock Mode

The MAX1061/MAX1063 operate with either an internal or an external clock. Control bits D6 and D7 select either internal or external clock mode. The parts retain the last-requested clock mode if a power-down mode is selected in the current input word. For both internal and external clock modes, internal or external acquisition can be used. At power-up, the MAX1061/MAX1063 enter the default external clock mode.

## Internal Clock Mode

Select internal clock mode to release the  $\mu$ P from the burden of running the SAR conversion clock. To select this mode, bit D7 of the control byte must be set to 1 and D6 must be set to zero. The internal clock frequency is then selected, resulting in a conversion time of 3.6 $\mu$ s. When using the internal clock mode, tie the CLK pin either high or low to prevent the pin from floating.

## External Clock Mode

To select the external clock mode, bits D6 and D7 of the control byte must be set to 1. Figure 6 shows the clock and  $\overline{WR}$  timing relationship for internal (Figure 6a) and external (Figure 6b) acquisition modes with an external clock. For proper operation, a 100kHz to 4.8MHz clock frequency with 30% to 70% duty cycle is recommended. Operating the MAX1061/MAX1063 with clock frequencies lower than 100kHz is not recom-

mended, because it causes a voltage droop across the hold capacitor in the T/H stage that results in degraded performance.

## Digital Interface

Input (control byte) and output data are multiplexed on a tri-state parallel interface. This parallel interface (I/O) can easily be interfaced with standard  $\mu$ Ps. The signals  $\overline{CS}$ ,  $\overline{WR}$ , and  $\overline{RD}$  control the write and read operations.  $\overline{CS}$  represents the chip-select signal, which enables a  $\mu$ P to address the MAX1061/MAX1063 as an I/O port. When high,  $\overline{CS}$  disables the CLK,  $\overline{WR}$ , and  $\overline{RD}$  inputs and forces the interface into a high-impedance (high-Z) state.

## Input Format

The control byte is latched into the device on pins D7–D0 during a write command. Table 2 shows the control byte format.

## Output Format

The output format for both the MAX1061/MAX1063 is binary in unipolar mode and two's complement in bipolar mode. When reading the output data,  $\overline{CS}$  and  $\overline{RD}$  must be low. When HBEN = 0, the lower 8 bits are read. With HBEN = 1, the upper 2 bits are available and the output data bits D7–D2 are set either low in unipolar mode or set to the value of the MSB in bipolar mode (Table 5).

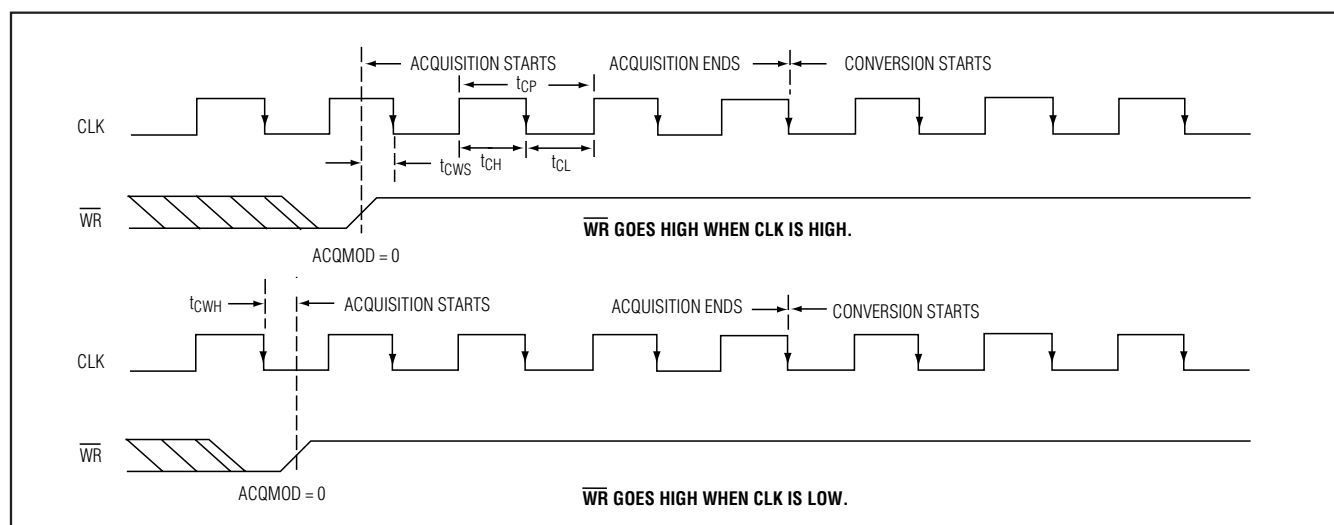

Figure 6a. External Clock and  $\overline{WR}$  Timing (Internal Acquisition Mode)

# 250ksp/s, +3V, 8-/4-Channel, 10-Bit ADCs with +2.5V Reference and Parallel Interface

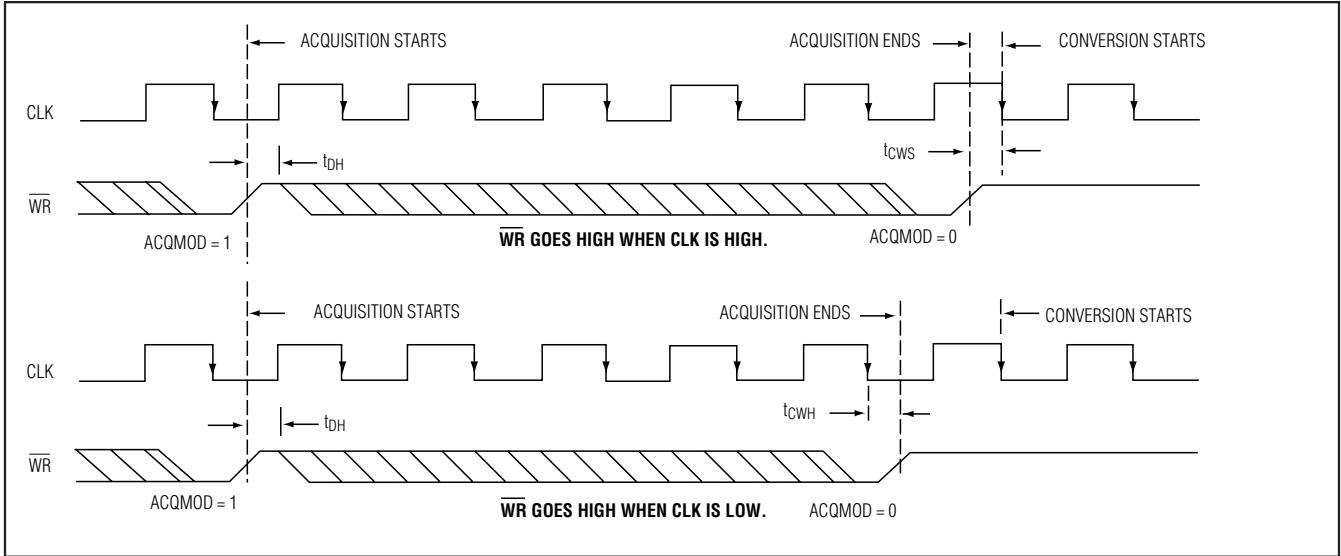

Figure 6b. External Clock and  $\overline{WR}$  Timing (External Acquisition Mode)

Table 2. Control Byte Format

D7 (MSB)	D6	D5	D4	D3	D2	D1	D0 (LSB)
PD1	PD0	ACQMOD	SGL/ $\overline{DIF}$	UNI/BIP	A2	A1	A0

Table 3. Channel Selection for Single-Ended Operation (SGL/ $\overline{DIF}$  = 1)

A2	A1	A0	CH0	CH1	CH2	CH3	CH4*	CH5*	CH6*	CH7*	COM
0	0	0	+								-
0	0	1		+							-
0	1	0			+						-
0	1	1				+					-
1	0	0					+				-
1	0	1						+			-
1	1	0							+		-
1	1	1								+	-

\*Channels CH4–CH7 apply to MAX1061 only.

# 250ksps, +3V, 8-/4-Channel, 10-Bit ADCs with +2.5V Reference and Parallel Interface

MAX1061/MAX1063

**Table 4. Channel Selection for Pseudo-Differential Operation (SGL/DIF = 0)**

A2	A1	A0	CH0	CH1	CH2	CH3	CH4*	CH5*	CH6*	CH7*
0	0	0	+	-						
0	0	1	-	+						
0	1	0			+	-				
0	1	1			-	+				
1	0	0					+	-		
1	0	1					-	+		
1	1	0							+	-
1	1	1							-	+

\*Channels CH4–CH7 apply to MAX1061 only.

## Applications Information

### Power-On Reset

When power is first applied, internal power-on reset circuitry activates the MAX1061/MAX1063 in external clock mode and sets INT high. After the power supplies stabilize, the internal reset time is 10μs, and no conversions should be attempted during this phase. When using the internal reference, 500μs are required for VREF to stabilize.

### Internal and External Reference

The MAX1061/MAX1063 can be used with an internal or external reference voltage. An external reference can be connected directly to REF or REFADJ.

An internal buffer is designed to provide +2.5V at REF for both the MAX1061 and the MAX1063. The internally trimmed +1.22V reference is buffered with a +2.05V/V gain.

### Internal Reference

With the internal reference, the full-scale range is +2.5V with unipolar inputs and ±1.25V with bipolar inputs. The internal reference buffer allows for small adjustments (±100mV) in the reference voltage (Figure 7).

**Note:** The reference buffer must be compensated with an external capacitor (4.7μF min) connected between REF and GND to reduce reference noise and switching spikes from the ADC. To further minimize noise on the reference, connect a 0.01μF capacitor between REFADJ and GND.

### External Reference

With both the MAX1061 and MAX1063, an external reference can be placed at either the input (REFADJ) or the output (REF) of the internal reference buffer amplifier.

Using the REFADJ input makes buffering the external reference unnecessary. The REFADJ input impedance is typically 17kΩ.

**Table 5. Data-Bus Output (8 + 2 Parallel Interface)**

PIN	HBEN = 0	HBEN = 1	
D0	Bit 0 (LSB)	Bit 8	
D1	Bit 1	Bit 9 (MSB)	
		BIPOLAR (UNI/BIP = 0)	UNIPOLAR (UNI/BIP = 1)
D2	Bit 2	Bit 9	0
D3	Bit 3	Bit 9	0
D4	Bit 4	Bit 9	0
D5	Bit 5	Bit 9	0
D6	Bit 6	Bit 9	0
D7	Bit 7	Bit 9	0

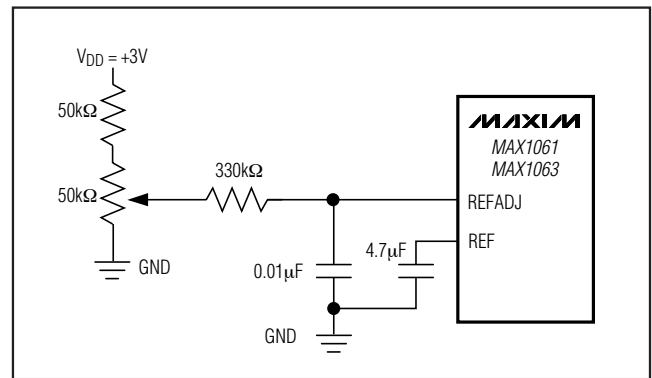

Figure 7. Reference Voltage Adjustment with External Potentiometer



## 250ksps, +3V, 8-/4-Channel, 10-Bit ADCs with +2.5V Reference and Parallel Interface

When applying an external reference to REF, disable the internal reference buffer by connecting REFADJ to V<sub>DD</sub>. The DC input resistance at REF is 25k $\Omega$ . Therefore, an external reference at REF must deliver up to 200 $\mu$ A DC load current during a conversion and have an output impedance less than 10 $\Omega$ . If the reference has higher output impedance or is noisy, bypass it close to the REF pin with a 4.7 $\mu$ F capacitor.

### Power-Down Modes

Save power by placing the converter in a low-current shutdown state between conversions. Select standby mode or shutdown mode using bits D6 and D7 of the control byte (Tables 1 and 2). In both software power-down modes, the parallel interface remains active, but the ADC does not convert.

### Standby Mode

While in standby mode, the supply current is 850 $\mu$ A (typ). The part powers up on the next rising edge on  $\overline{WR}$  and is ready to perform conversions. This quick turn-on time allows the user to realize significantly reduced power consumption for conversion rates below 250ksps.

### Shutdown Mode

Shutdown mode turns off all chip functions that draw quiescent current, reducing the typical supply current to 2 $\mu$ A immediately after the current conversion is complet-

ed. A rising edge on  $\overline{WR}$  causes the MAX1061/MAX1063 to exit shutdown mode and return to normal operation. To achieve full 10-bit accuracy with a 4.7 $\mu$ F reference bypass capacitor, 500 $\mu$ s is required after power-up. Waiting 500 $\mu$ s in standby mode, instead of in full-power mode, can reduce power consumption by a factor of 3 or more. When using an external reference, only 50 $\mu$ s is required after power-up. Enter standby mode by performing a dummy conversion with the control byte specifying standby mode.

**Note:** Bypassing capacitors larger than 4.7 $\mu$ F between REF and GND results in longer power-up delays.

### Transfer Function

Table 6 shows the full-scale voltage ranges for unipolar and bipolar modes.

Figure 8 depicts the nominal, unipolar input/output (I/O) transfer function and Figure 9 shows the bipolar I/O transfer function. Code transitions occur halfway between successive-integer LSB values. Output coding is binary, with 1 LSB = V<sub>REF</sub> / 1024.

### Maximum Sampling Rate/ Achieving 300ksps

When running at the maximum clock frequency of 4.8MHz, the specified throughput of 250ksps is achieved by completing a conversion every 19 clock cycles: 1 write cycle, 3 acquisition cycles, 13 conver-

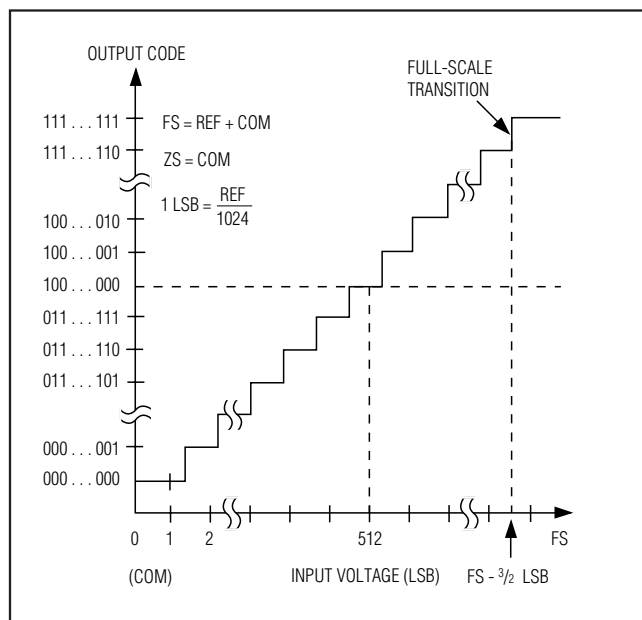

Figure 8. Unipolar Transfer Function

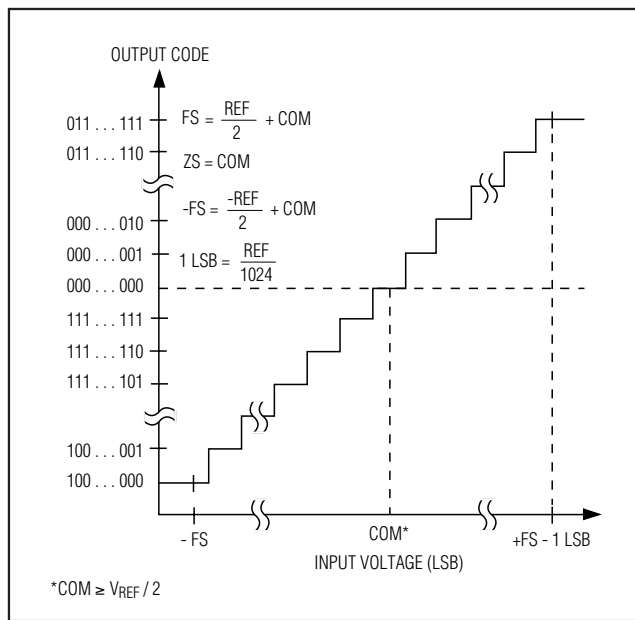

Figure 9. Bipolar Transfer Function



## 250ksps, +3V, 8-/4-Channel, 10-Bit ADCs with +2.5V Reference and Parallel Interface

**Table 6. Full Scale and Zero Scale for Unipolar and Bipolar Operation**

UNIPOLAR MODE		BIPOLAR MODE	
Full scale	V <sub>REF</sub> + COM	Positive full scale	V <sub>REF</sub> /2 + COM
Zero scale	COM	Zero scale	COM
—	—	Negative full scale	-V <sub>REF</sub> /2 + COM

sion cycles, and 2 read cycles. This assumes that the results of the last conversion are read before the next control byte is written. Throughputs up to 300ksps can be achieved by first writing a control word to begin the acquisition cycle of the next conversion, then reading the results of the previous conversion from the bus (Figure 10). This technique allows a conversion to be completed every 16 clock cycles. Note that the switching of the data bus during acquisition or conversion can cause additional supply noise, which can make it difficult to achieve true 10-bit performance.

### Layout, Grounding, and Bypassing

For best performance, use printed circuit (PC) boards. Wire-wrap configurations are not recommended since the layout should ensure proper separation of analog and digital traces. Do not run analog and digital lines parallel to each other, and do not lay out digital signal paths underneath the ADC package. Use separate analog and digital PC board ground sections with only one star point (Figure 11) connecting the two ground systems (analog and digital). For lowest noise operation, ensure the ground return to the star ground's power supply is low impedance and as short as possible. Route digital signals far away from sensitive analog and reference inputs.

High-frequency noise in the power supply (V<sub>DD</sub>) could influence the proper operation of the ADC's fast comparator. Bypass V<sub>DD</sub> to the star ground with a network of two parallel capacitors, 0.1μF and 4.7μF, located as close as possible to the MAX1061/MAX1063s' power-supply pin. Minimize capacitor lead length for best supply-noise rejection; add an attenuation resistor (5Ω) if the power supply is extremely noisy.

### Definitions

#### Integral Nonlinearity

Integral nonlinearity (INL) is the deviation of the values on an actual transfer function from a straight line. This straight line can be either a best-straight-line fit or a line drawn between the end points of the transfer function, once offset and gain errors have been nullified. The static linearity parameters for the MAX1061/MAX1063 are measured using the end-point method.

#### Differential Nonlinearity

Differential nonlinearity (DNL) is the difference between an actual step width and the ideal value of 1 LSB. A DNL error specification of less than 1 LSB guarantees no missing codes and a monotonic transfer function.

#### Aperture Definitions

Aperture jitter (t<sub>AJ</sub>) is the sample-to-sample variation in the time between the samples. Aperture delay (t<sub>AD</sub>) is the time between the rising edge of the sampling clock and the instant when an actual sample is taken.

#### Signal-to-Noise Ratio

For a waveform perfectly reconstructed from digital samples, signal-to-noise ratio (SNR) is the ratio of the full-scale analog input (RMS value) to the RMS quantization error (residual error). The ideal, theoretical minimum analog-to-digital noise is caused by quantization error only and results directly from the ADC's resolution (N bits):

$$\text{SNR} = (6.02 \times N + 1.76)\text{dB}$$

In reality, there are other noise sources besides quantization noise: thermal noise, reference noise, clock jitter, etc. Therefore, SNR is computed by taking the ratio of the RMS signal to the RMS noise, which includes all spectral components minus the fundamental, the first five harmonics, and the DC offset.

#### Signal-to-Noise Plus Distortion

Signal-to-noise plus distortion (SINAD) is the ratio of the fundamental input frequency's RMS amplitude to the RMS equivalent of all other ADC output signals:

$$\text{SINAD (dB)} = 20 \times \log(\text{Signal}_{\text{RMS}} / \text{Noise}_{\text{RMS}})$$

#### Effective Number of Bits

Effective number of bits (ENOB) indicates the global accuracy of an ADC at a specific input frequency and sampling rate. An ideal ADC error consists of quantization noise only. With an input range equal to the full-scale range of the ADC, calculate the effective number of bits as follows:

$$\text{ENOB} = (\text{SINAD} - 1.76) / 6.02$$

# 250ksp/s, +3V, 8-/4-Channel, 10-Bit ADCs with +2.5V Reference and Parallel Interface

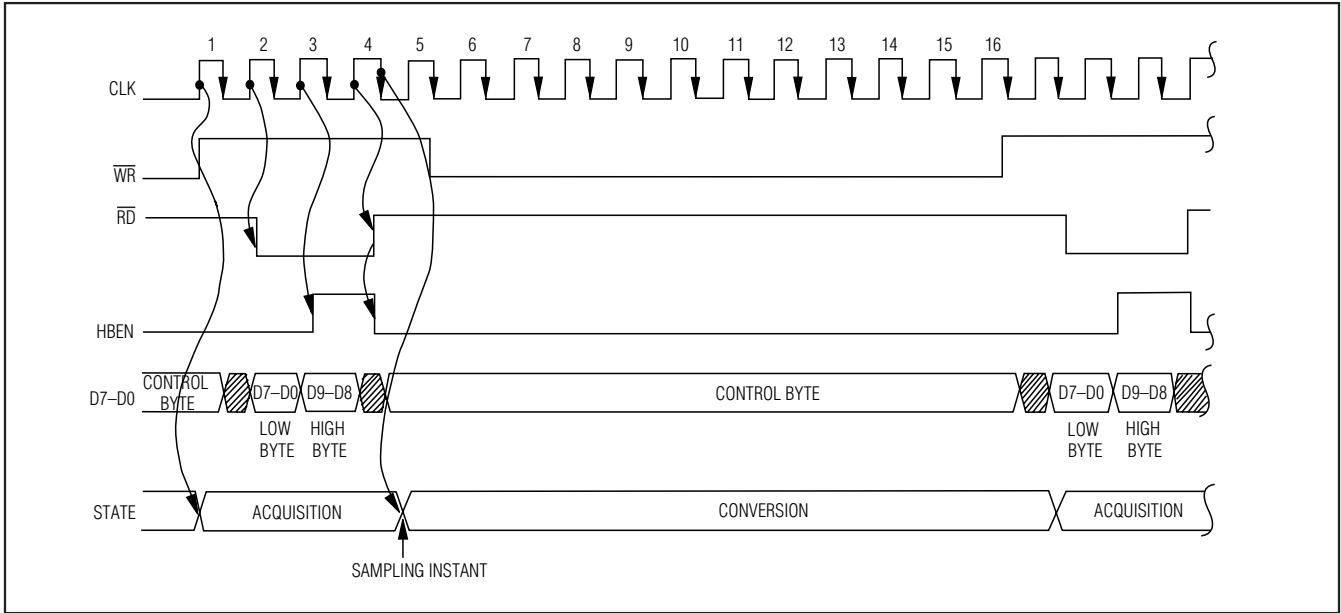

Figure 10. Timing Diagram for Fastest Conversion

### Total Harmonic Distortion

Total harmonic distortion (THD) is the ratio of the RMS sum of the first five harmonics of the input signal to the fundamental itself. This is expressed as:

$$THD = 20 \times \log \left( \frac{\sqrt{V_2^2 + V_3^2 + V_4^2 + V_5^2}}{V_1} \right)$$

where  $V_1$  is the fundamental amplitude, and  $V_2$  through  $V_5$  are the amplitudes of the 2nd- through 5th-order harmonics.

### Spurious-Free Dynamic Range

Spurious-free dynamic range (SFDR) is the ratio of the RMS amplitude of the fundamental (maximum signal component) to the RMS value of the next-largest distortion component.

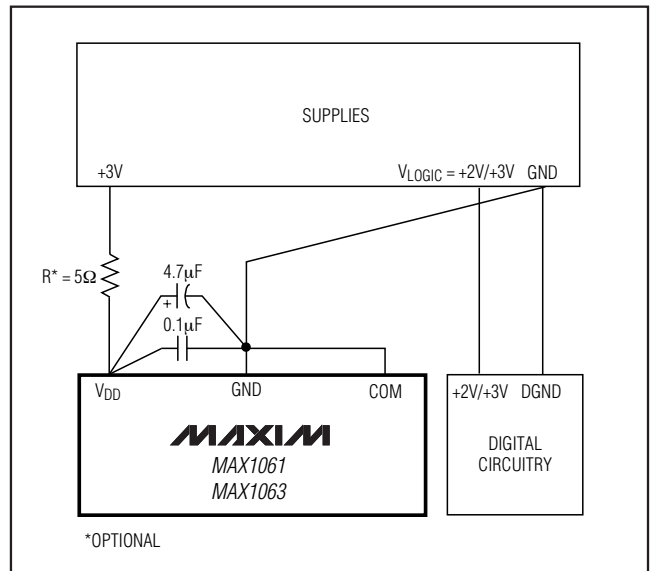
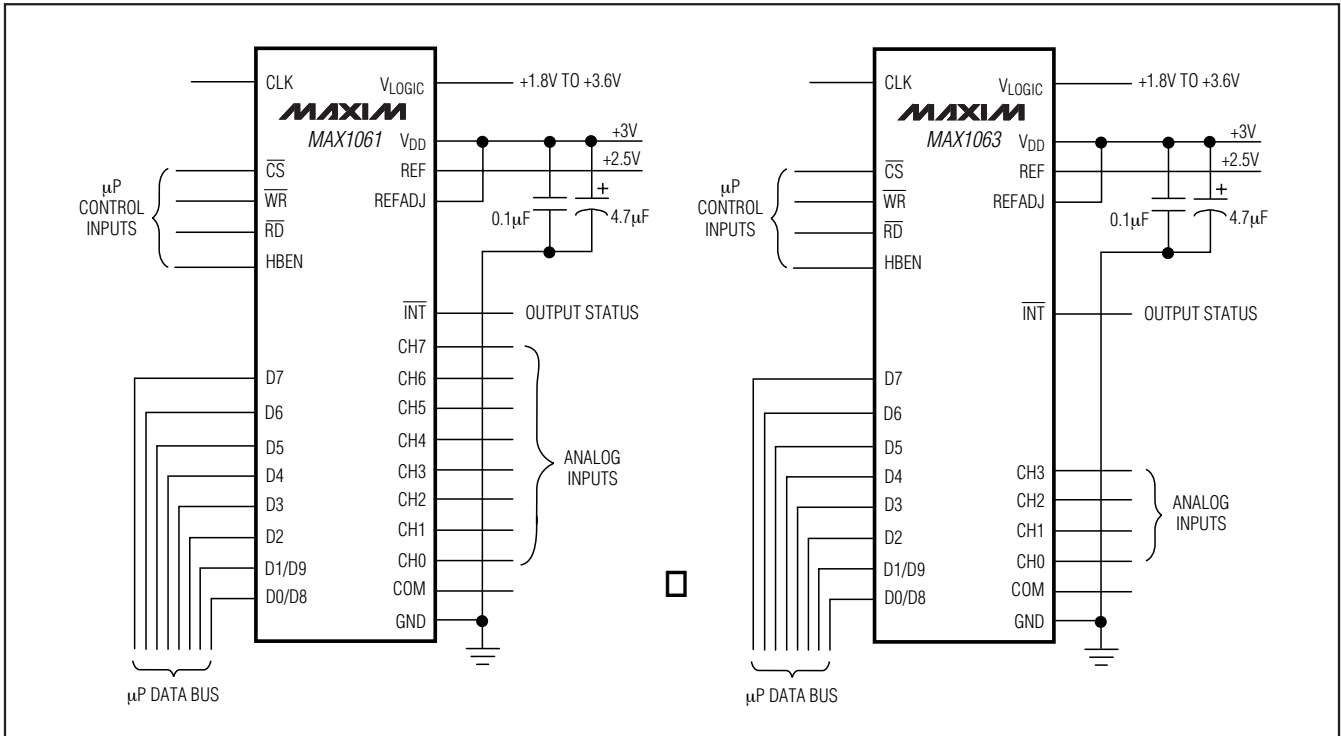

Figure 11. Power-Supply and Grounding Connections

# 250ksps, +3V, 8-/4-Channel, 10-Bit ADCs with +2.5V Reference and Parallel Interface

## Typical Operating Circuits

MAX1061/MAX1063



### Pin Configurations (continued)

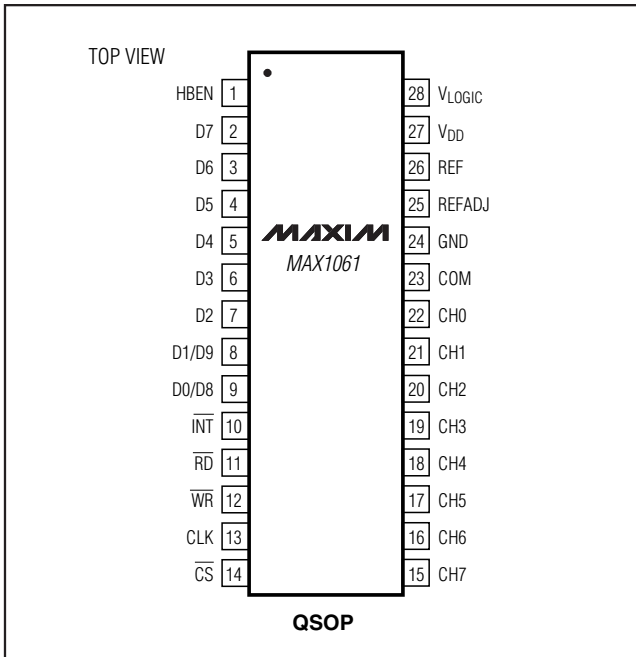

### Ordering Information (continued)

PART	TEMP RANGE	PIN-PACKAGE	INL (LSB)
MAX1063ACEG+	0°C to +70°C	24 QSOP	±0.5
MAX1063BCEG+	0°C to +70°C	24 QSOP	±1
MAX1063AEEG+	-40°C to +85°C	24 QSOP	±0.5
MAX1063BEEG+	-40°C to +85°C	24 QSOP	±1

+ Denotes a lead(Pb)-free/RoHS-compliant package.

### Chip Information

TRANSISTOR COUNT: 5781

### Package Information

For the latest package outline information and land patterns, go to [www.maxim-ic.com/packages](http://www.maxim-ic.com/packages).

PACKAGE TYPE	PACKAGE CODE	DOCUMENT NO.
28 QSOP	E28+1	<a href="#">21-0055</a>
24 QSOP	E24+2	<a href="#">21-0055</a>

# **250ksps, +3V, 8-/4-Channel, 10-Bit ADCs with +2.5V Reference and Parallel Interface**

## **Revision History**

<b>REVISION NUMBER</b>	<b>REVISION DATE</b>	<b>DESCRIPTION</b>	<b>PAGES CHANGED</b>
0	4/03	Initial release	—
1	3/09	Updated <i>Ordering Information</i> table with lead-free information and updated <i>Package Information</i> section	1, 19, 20

Maxim cannot assume responsibility for use of any circuitry other than circuitry entirely embodied in a Maxim product. No circuit patent licenses are implied. Maxim reserves the right to change the circuitry and specifications without notice at any time.

20 \_\_\_\_\_ **Maxim Integrated Products, 120 San Gabriel Drive, Sunnyvale, CA 94086 408-737-7600**



Компания «ЭлектроПласт» предлагает заключение долгосрочных отношений при поставках импортных электронных компонентов на взаимовыгодных условиях!

Наши преимущества:

- Оперативные поставки широкого спектра электронных компонентов отечественного и импортного производства напрямую от производителей и с крупнейших мировых складов;
- Поставка более 17-ти миллионов наименований электронных компонентов;
- Поставка сложных, дефицитных, либо снятых с производства позиций;
- Оперативные сроки поставки под заказ (от 5 рабочих дней);
- Экспресс доставка в любую точку России;
- Техническая поддержка проекта, помощь в подборе аналогов, поставка прототипов;
- Система менеджмента качества сертифицирована по Международному стандарту ISO 9001;
- Лицензия ФСБ на осуществление работ с использованием сведений, составляющих государственную тайну;
- Поставка специализированных компонентов (Xilinx, Altera, Analog Devices, Intersil, Interpoint, Microsemi, Aeroflex, Peregrine, Syfer, Eurofarad, Texas Instrument, Miteq, Cobham, E2V, MA-COM, Hittite, Mini-Circuits, General Dynamics и др.);

Помимо этого, одним из направлений компании «ЭлектроПласт» является направление «Источники питания». Мы предлагаем Вам помощь Конструкторского отдела:

- Подбор оптимального решения, техническое обоснование при выборе компонента;
- Подбор аналогов;
- Консультации по применению компонента;
- Поставка образцов и прототипов;
- Техническая поддержка проекта;
- Защита от снятия компонента с производства.



#### Как с нами связаться

**Телефон:** 8 (812) 309 58 32 (многоканальный)

**Факс:** 8 (812) 320-02-42

**Электронная почта:** [org@eplast1.ru](mailto:org@eplast1.ru)

**Адрес:** 198099, г. Санкт-Петербург, ул. Калинина, дом 2, корпус 4, литера А.