

# BAS19L, NSVBAS19L, BAS20L, SBAS20L, BAS21L, SBAS21L, BAS21DW5, SBAS21DW5

## High Voltage Switching Diode

### Features

- These Devices are Pb-Free, Halogen Free/BFR Free and are RoHS Compliant
- S and NSV Prefixes for Automotive and Other Applications Requiring Unique Site and Control Change Requirements; AEC-Q101 Qualified and PPAP Capable

### MAXIMUM RATINGS

Rating	Symbol	Value	Unit
Continuous Reverse Voltage BAS19, NSVBAS19 BAS20, SBAS20 BAS21, SBAS21	$V_R$	120 200 250	Vdc
Repetitive Peak Reverse Voltage BAS19, NSVBAS19 BAS20, SBAS20 BAS21, SBAS21	$V_{RRM}$	120 200 250	Vdc
Continuous Forward Current	$I_F$	200	mAdc
Peak Forward Surge Current	$I_{FM(surge)}$	625	mAdc
Junction and Storage Temperature Range	$T_J, T_{stg}$	-55 to +150	°C
Power Dissipation (Note 1)	$P_D$	385	mW
Electrostatic Discharge	ESD	HM < 500 MM < 400	V V

Stresses exceeding Maximum Ratings may damage the device. Maximum Ratings are stress ratings only. Functional operation above the Recommended Operating Conditions is not implied. Extended exposure to stresses above the Recommended Operating Conditions may affect device reliability.

1. Mounted on FR-5 Board = 1.0 x 0.75 x 0.062 in.



ON Semiconductor®

<http://onsemi.com>

## HIGH VOLTAGE SWITCHING DIODE



### MARKING DIAGRAMS



SOT-23 (TO-236)  
CASE 318  
STYLE 8



SC-88A (SOT-353)  
CASE 419A



- x = P, R, or S
- P = BAS19L, NSVBAS19L
- R = BAS20L, SBAS20L
- S = BAS21L, SBAS21L or BAS21DW5, SBAS21DW5
- M = Date Code
- = Pb-Free Package

(Note: Microdot may be in either location)

\*Date Code orientation and/or overbar may vary depending upon the manufacturing location.

### ORDERING INFORMATION

See detailed ordering and shipping information in the package dimensions section on page 4 of this data sheet.

**BAS19L, NSVBAS19L, BAS20L, SBAS20L, BAS21L, SBAS21L, BAS21DW5,  
SBAS21DW5**

**THERMAL CHARACTERISTICS (SOT-23)**

Characteristic	Symbol	Max	Unit
Total Device Dissipation FR-5 Board (Note 2) $T_A = 25^\circ\text{C}$ Derate above $25^\circ\text{C}$	$P_D$	225 1.8	mW mW/ $^\circ\text{C}$
Thermal Resistance Junction-to-Ambient (SOT-23)	$R_{\theta JA}$	556	$^\circ\text{C}/\text{W}$
Total Device Dissipation Alumina Substrate (Note 3) $T_A = 25^\circ\text{C}$ Derate above $25^\circ\text{C}$	$P_D$	300 2.4	mW mW/ $^\circ\text{C}$
Thermal Resistance Junction-to-Ambient	$R_{\theta JA}$	417	$^\circ\text{C}/\text{W}$
Junction and Storage Temperature Range	$T_J, T_{stg}$	-55 to +150	$^\circ\text{C}$

**THERMAL CHARACTERISTICS (SC-88A)**

Characteristic	Symbol	Max	Unit
Power Dissipation (Note 4)	$P_D$	385	mW
Thermal Resistance - Junction-to-Ambient Derate Above $25^\circ\text{C}$	$R_{\theta JA}$	328 3.0	$^\circ\text{C}/\text{W}$ mW/ $^\circ\text{C}$
Maximum Junction Temperature	$T_{Jmax}$	150	$^\circ\text{C}$
Operating Junction and Storage Temperature Range	$T_J, T_{stg}$	-55 to +150	$^\circ\text{C}$

2. FR-5 =  $1.0 \times 0.75 \times 0.062$  in.
3. Alumina =  $0.4 \times 0.3 \times 0.024$  in. 99.5% alumina.
4. Mounted on FR-5 Board =  $1.0 \times 0.75 \times 0.062$  in.

**ELECTRICAL CHARACTERISTICS ( $T_A = 25^\circ\text{C}$  unless otherwise noted)**

Characteristic	Symbol	Min	Max	Unit
Reverse Voltage Leakage Current ( $V_R = 100$ Vdc)      BAS19, NSVBAS19 ( $V_R = 150$ Vdc)      BAS20, SBAS20 ( $V_R = 200$ Vdc)      BAS21, SBAS21 ( $V_R = 100$ Vdc, $T_J = 150^\circ\text{C}$ )      BAS19 ( $V_R = 150$ Vdc, $T_J = 150^\circ\text{C}$ )      BAS20, SBAS20 ( $V_R = 200$ Vdc, $T_J = 150^\circ\text{C}$ )      BAS21, SBAS21	$I_R$	- - - - - -	0.1 0.1 0.1 100 100 100	$\mu\text{A}dc$
Reverse Breakdown Voltage ( $I_{BR} = 100$ $\mu\text{A}dc$ )      BAS19, NSVBAS19 ( $I_{BR} = 100$ $\mu\text{A}dc$ )      BAS20, SBAS20 ( $I_{BR} = 100$ $\mu\text{A}dc$ )      BAS21, SBAS21	$V_{(BR)}$	120 200 250	- - -	Vdc
Forward Voltage ( $I_F = 100$ mA)dc ( $I_F = 200$ mA)dc	$V_F$	- -	1.0 1.25	Vdc
Diode Capacitance ( $V_R = 0$ , $f = 1.0$ MHz)	$C_D$	-	5.0	pF
Reverse Recovery Time ( $I_F = I_R = 30$ mA)dc, $I_{R(REC)} = 3.0$ mA)dc, $R_L = 100$ )	$t_{rr}$	-	50	ns

**BAS19L, NSVBAS19L, BAS20L, SBAS20L, BAS21L, SBAS21L, BAS21DW5, SBAS21DW5**



- Notes: 1. A 2.0 kΩ variable resistor adjusted for a Forward Current ( $I_F$ ) of 30 mA.  
 2. Input pulse is adjusted so  $I_{R(\text{peak})}$  is equal to 30 mA.  
 3.  $t_p \gg t_{rr}$

**Figure 1. Recovery Time Equivalent Test Circuit**



**Figure 2.  $V_F$  vs.  $I_F$**



**Figure 3.  $I_R$  vs.  $V_R$**



**Figure 4. Capacitance**

**BAS19L, NSVBAS19L, BAS20L, SBAS20L, BAS21L, SBAS21L, BAS21DW5,  
SBAS21DW5**

**ORDERING INFORMATION**

<b>Device</b>	<b>Package</b>	<b>Shipping†</b>
BAS19LT1G	SOT-23 (Pb-Free)	3000 / Tape & Reel
BAS19LT3G	SOT-23 (Pb-Free)	10000 / Tape & Reel
NSVBAS19LT1G*	SOT-23 (Pb-Free)	3000 / Tape & Reel
BAS20LT1G	SOT-23 (Pb-Free)	3000 / Tape & Reel
BAS20LT3G	SOT-23 (Pb-Free)	10000 / Tape & Reel
SBAS20LT1G*	SOT-23 (Pb-Free)	3000 / Tape & Reel
BAS21LT1G	SOT-23 (Pb-Free)	3000 / Tape & Reel
SBAS21LT1G*	SOT-23 (Pb-Free)	3000 / Tape & Reel
BAS21LT3G	SOT-23 (Pb-Free)	10000 / Tape & Reel
SBAS21LT3G*	SOT-23 (Pb-Free)	10000 / Tape & Reel
BAS21DW5T1G	SC-88A (Pb-Free)	3000 / Tape & Reel
SBAS21DW5T1G*	SC-88A (Pb-Free)	3000 / Tape & Reel
SBAS21DW5T3G*	SC-88A (Pb-Free)	10000 / Tape & Reel

†For information on tape and reel specifications, including part orientation and tape sizes, please refer to our Tape and Reel Packaging Specifications Brochure, BRD8011/D.

\*S and NSV Prefixes for Automotive and Other Applications Requiring Unique Site and Control Change Requirements; AEC-Q101 Qualified and PPAP Capable.

# BAS19L, NSVBAS19L, BAS20L, SBAS20L, BAS21L, SBAS21L, BAS21DW5, SBAS21DW5

## PACKAGE DIMENSIONS

SOT-23 (TO-236)  
CASE 318-08  
ISSUE AP



- NOTES:
1. DIMENSIONING AND TOLERANCING PER ANSI Y14.5M, 1982.
  2. CONTROLLING DIMENSION: INCH.
  3. MAXIMUM LEAD THICKNESS INCLUDES LEAD FINISH THICKNESS. MINIMUM LEAD THICKNESS IS THE MINIMUM THICKNESS OF BASE MATERIAL.
  4. DIMENSIONS D AND E DO NOT INCLUDE MOLD FLASH, PROTRUSIONS, OR GATE BURRS.

DIM	MILLIMETERS			INCHES		
	MIN	NOM	MAX	MIN	NOM	MAX
A	0.89	1.00	1.11	0.035	0.040	0.044
A1	0.01	0.06	0.10	0.001	0.002	0.004
b	0.37	0.44	0.50	0.015	0.018	0.020
c	0.09	0.13	0.18	0.003	0.005	0.007
D	2.80	2.90	3.04	0.110	0.114	0.120
E	1.20	1.30	1.40	0.047	0.051	0.055
e	1.78	1.90	2.04	0.070	0.075	0.081
L	0.10	0.20	0.30	0.004	0.008	0.012
L1	0.35	0.54	0.69	0.014	0.021	0.029
HE	2.10	2.40	2.64	0.083	0.094	0.104
θ	0°	---	10°	0°	---	10°

STYLE 8:  
PIN 1. ANODE  
2. NO CONNECTION  
3. CATHODE

### SOLDERING FOOTPRINT\*

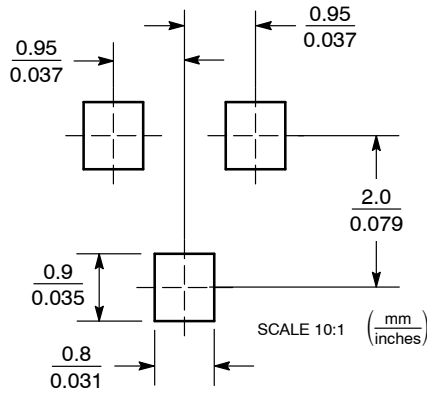

\*For additional information on our Pb-Free strategy and soldering details, please download the ON Semiconductor Soldering and Mounting Techniques Reference Manual, SOLDERRM/D.

# BAS19L, NSVBAS19L, BAS20L, SBAS20L, BAS21L, SBAS21L, BAS21DW5, SBAS21DW5

## PACKAGE DIMENSIONS

SC-88A (SC-70-5/SOT-353)  
CASE 419A-02  
ISSUE K



NOTES:

1. DIMENSIONING AND TOLERANCING PER ANSI Y14.5M, 1982.
2. CONTROLLING DIMENSION: INCH.
3. 419A-01 OBSOLETE. NEW STANDARD 419A-02.
4. DIMENSIONS A AND B DO NOT INCLUDE MOLD FLASH, PROTRUSIONS, OR GATE BURRS.

DIM	INCHES		MILLIMETERS	
	MIN	MAX	MIN	MAX
A	0.071	0.087	1.80	2.20
B	0.045	0.053	1.15	1.35
C	0.031	0.043	0.80	1.10
D	0.004	0.012	0.10	0.30
G	0.026 BSC		0.65 BSC	
H	---	0.004	---	0.10
J	0.004	0.010	0.10	0.25
K	0.004	0.012	0.10	0.30
N	0.008 REF		0.20 REF	
S	0.079	0.087	2.00	2.20

### SOLDERING FOOTPRINT\*

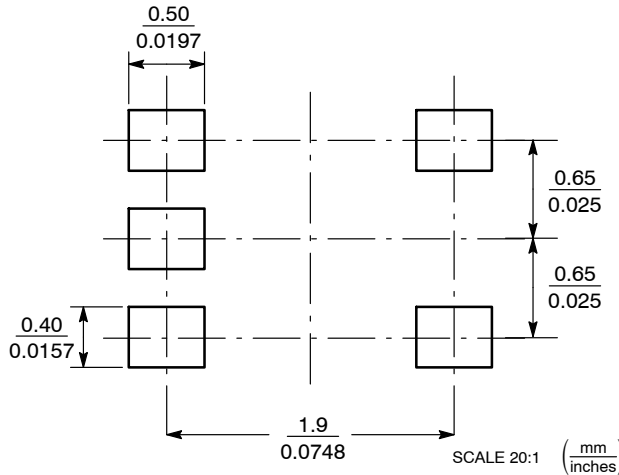

\*For additional information on our Pb-Free strategy and soldering details, please download the ON Semiconductor Soldering and Mounting Techniques Reference Manual, SOLDERRM/D.

ON Semiconductor and are registered trademarks of Semiconductor Components Industries, LLC (SCILLC). SCILLC reserves the right to make changes without further notice to any products herein. SCILLC makes no warranty, representation or guarantee regarding the suitability of its products for any particular purpose, nor does SCILLC assume any liability arising out of the application or use of any product or circuit, and specifically disclaims any and all liability, including without limitation special, consequential or incidental damages. "Typical" parameters which may be provided in SCILLC data sheets and/or specifications can and do vary in different applications and actual performance may vary over time. All operating parameters, including "Typicals" must be validated for each customer application by customer's technical experts. SCILLC does not convey any license under its patent rights nor the rights of others. SCILLC products are not designed, intended, or authorized for use as components in systems intended for surgical implant into the body, or other applications intended to support or sustain life, or for any other application in which the failure of the SCILLC product could create a situation where personal injury or death may occur. Should Buyer purchase or use SCILLC products for any such unintended or unauthorized application, Buyer shall indemnify and hold SCILLC and its officers, employees, subsidiaries, affiliates, and distributors harmless against all claims, costs, damages, and expenses, and reasonable attorney fees arising out of, directly or indirectly, any claim of personal injury or death associated with such unintended or unauthorized use, even if such claim alleges that SCILLC was negligent regarding the design or manufacture of the part. SCILLC is an Equal Opportunity/Affirmative Action Employer. This literature is subject to all applicable copyright laws and is not for resale in any manner.

### PUBLICATION ORDERING INFORMATION

**LITERATURE FULFILLMENT:**  
Literature Distribution Center for ON Semiconductor  
P.O. Box 5163, Denver, Colorado 80217 USA  
Phone: 303-675-2175 or 800-344-3860 Toll Free USA/Canada  
Fax: 303-675-2176 or 800-344-3867 Toll Free USA/Canada  
Email: orderlit@onsemi.com

**N. American Technical Support:** 800-282-9855 Toll Free  
USA/Canada  
**Europe, Middle East and Africa Technical Support:**  
Phone: 421 33 790 2910  
**Japan Customer Focus Center**  
Phone: 81-3-5817-1050

**ON Semiconductor Website:** [www.onsemi.com](http://www.onsemi.com)  
**Order Literature:** <http://www.onsemi.com/orderlit>  
For additional information, please contact your local Sales Representative



Компания «ЭлектроПласт» предлагает заключение долгосрочных отношений при поставках импортных электронных компонентов на взаимовыгодных условиях!

Наши преимущества:

- Оперативные поставки широкого спектра электронных компонентов отечественного и импортного производства напрямую от производителей и с крупнейших мировых складов;
- Поставка более 17-ти миллионов наименований электронных компонентов;
- Поставка сложных, дефицитных, либо снятых с производства позиций;
- Оперативные сроки поставки под заказ (от 5 рабочих дней);
- Экспресс доставка в любую точку России;
- Техническая поддержка проекта, помощь в подборе аналогов, поставка прототипов;
- Система менеджмента качества сертифицирована по Международному стандарту ISO 9001;
- Лицензия ФСБ на осуществление работ с использованием сведений, составляющих государственную тайну;
- Поставка специализированных компонентов (Xilinx, Altera, Analog Devices, Intersil, Interpoint, Microsemi, Aeroflex, Peregrine, Syfer, Eurofarad, Texas Instrument, Miteq, Cobham, E2V, MA-COM, Hittite, Mini-Circuits, General Dynamics и др.);

Помимо этого, одним из направлений компании «ЭлектроПласт» является направление «Источники питания». Мы предлагаем Вам помощь Конструкторского отдела:

- Подбор оптимального решения, техническое обоснование при выборе компонента;
- Подбор аналогов;
- Консультации по применению компонента;
- Поставка образцов и прототипов;
- Техническая поддержка проекта;
- Защита от снятия компонента с производства.



#### Как с нами связаться

**Телефон:** 8 (812) 309 58 32 (многоканальный)

**Факс:** 8 (812) 320-02-42

**Электронная почта:** [org@eplast1.ru](mailto:org@eplast1.ru)

**Адрес:** 198099, г. Санкт-Петербург, ул. Калинина, дом 2, корпус 4, литера А.