

InGaP HBT GAIN BLOCK MMIC AMPLIFIER, DC - 8 GHz

Typical Applications

An excellent cascadable 50 Ohm Gain Block or LO Driver for:

- Microwave & VSAT Radios
- Test Equipment
- Military EW, ECM, C³I
- Space Telecom

Functional Diagram

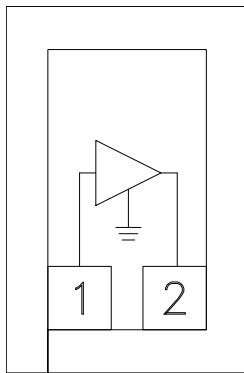

Features

- Gain: 12 dB
- P1dB Output Power: +14 dBm
- Stable Gain Over Temperature
- 50 Ohm I/O's
- Small Size: 0.38 x 0.58 x 0.1 mm

General Description

The HMC396 die is a GaAs InGaP Heterojunction Bipolar Transistor (HBT) Gain Block MMIC DC to 8 GHz amplifier. This amplifier can be used as either a cascadable 50 Ohm gain stage or to drive the LO of HMC mixers with up to +16 dBm output power. The HMC396 offers 12 dB of gain and an output IP3 of +30 dBm while requiring only 56 mA from a +5V supply. The Darlington feedback pair used results in reduced sensitivity to normal process variations and yields excellent gain stability over temperature while requiring a minimal number of external bias components. The HMC396 can easily be integrated into Multi-Chip-Modules (MCMs) due to its small (0.22mm²) size. All data is with the chip in a 50 Ohm test fixture connected via 0.025mm (1 mil) diameter wire bonds of minimal length 0.5mm (20 mils).

Electrical Specifications, $V_s = +5.0V$, $R_{bias} = 22 \text{ Ohm}$, $T_A = +25^\circ \text{ C}$

Parameter		Min.	Typ.	Max.	Units
Gain	DC - 4.0 GHz		12		dB
	4.0 - 8.0 GHz		11		dB
Gain Variation Over Temperature	DC - 4.0 GHz		0.004		dB/ °C
	4.0 - 8.0 GHz		0.015		dB/ °C
Input Return Loss	DC - 4.0 GHz		15		dB
	4.0 - 8.0 GHz		12		dB
Output Return Loss	DC - 4.0 GHz		19		dB
	4.0 - 8.0 GHz		17		dB
Reverse Isolation	DC - 8.0 GHz		16		dB
Output Power for 1 dB Compression (P1dB)	DC - 4.0 GHz		14		dBm
	4.0 - 8.0 GHz		13		dBm
Output Third Order Intercept (IP3)	DC - 4.0 GHz		30		dBm
	4.0 - 8.0 GHz		24		dBm
Noise Figure	DC - 8.0 GHz		6		dB
Supply Current (I _{cq})			56		mA

Note: Data taken with broadband bias tee on device output.

Information furnished by Analog Devices is believed to be accurate and reliable. However, no responsibility is assumed by Analog Devices for its use, nor for any infringements of patents or other rights of third parties that may result from its use. Specifications subject to change without notice. No license is granted by implication or otherwise under any patent or patent rights of Analog Devices. Trademarks and registered trademarks are the property of their respective owners.

For price, delivery, and to place orders: Analog Devices, Inc., One Technology Way, P.O. Box 9106, Norwood, MA 02062-9106
Phone: 781-329-4700 • Order online at www.analog.com
Application Support: Phone: 1-800-ANALOG-D

**InGaP HBT GAIN BLOCK
MMIC AMPLIFIER, DC - 8 GHz**

Gain & Return Loss

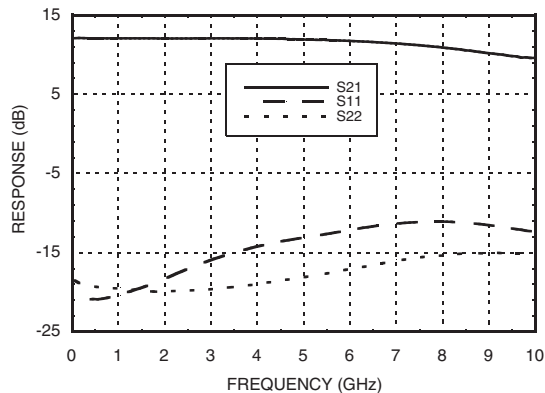

Gain vs. Temperature

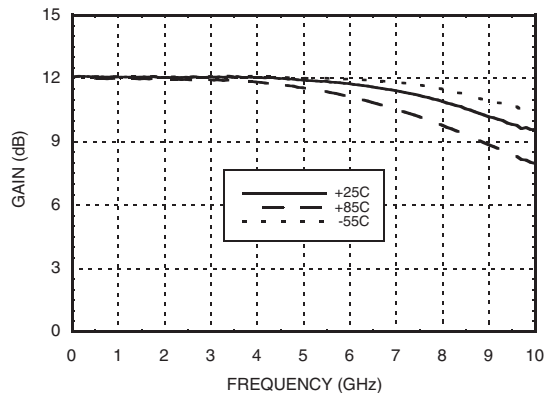

Input Return Loss vs. Temperature

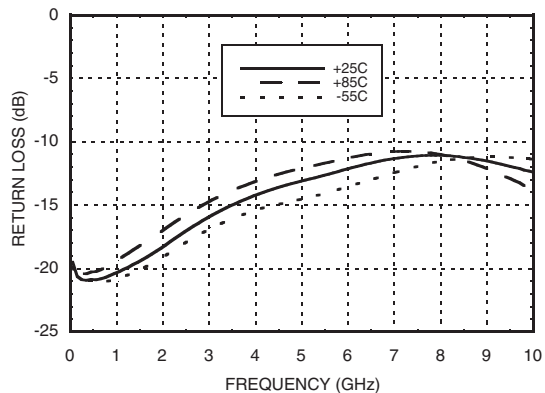

Output Return Loss vs. Temperature

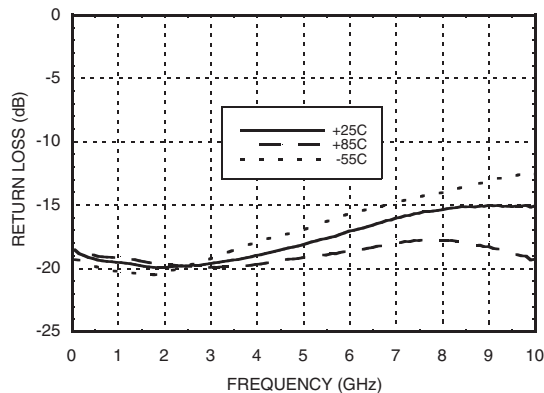

Reverse Isolation vs. Temperature

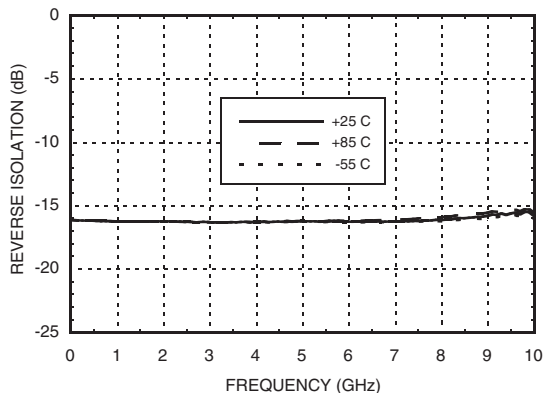

Noise Figure vs. Temperature

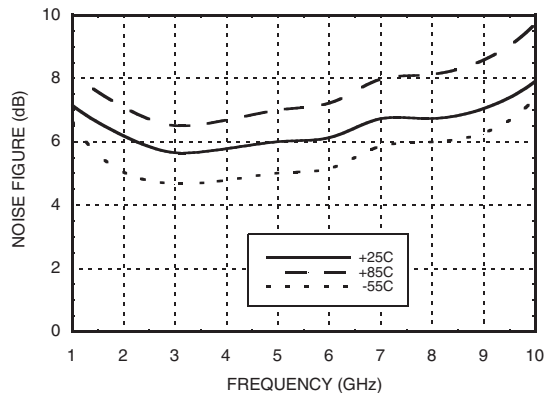

Information furnished by Analog Devices is believed to be accurate and reliable. However, no responsibility is assumed by Analog Devices for its use, nor for any infringements of patents or other rights of third parties that may result from its use. Specifications subject to change without notice. No license is granted by implication or otherwise under any patent or patent rights of Analog Devices. Trademarks and registered trademarks are the property of their respective owners.

For price, delivery, and to place orders: Analog Devices, Inc., One Technology Way, P.O. Box 9106, Norwood, MA 02062-9106 Phone: 781-329-4700 • Order online at www.analog.com Application Support: Phone: 1-800-ANALOG-D

**InGaP HBT GAIN BLOCK
MMIC AMPLIFIER, DC - 8 GHz**

P1dB vs. Temperature

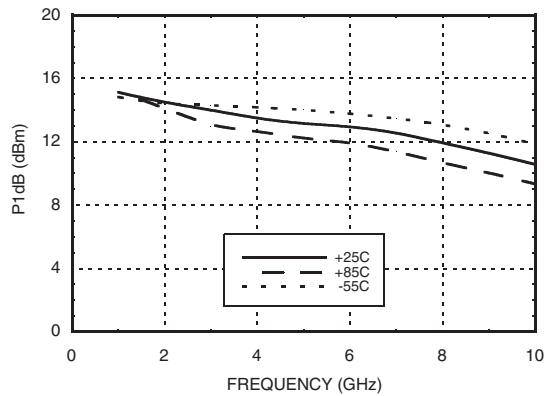

Psat vs. Temperature

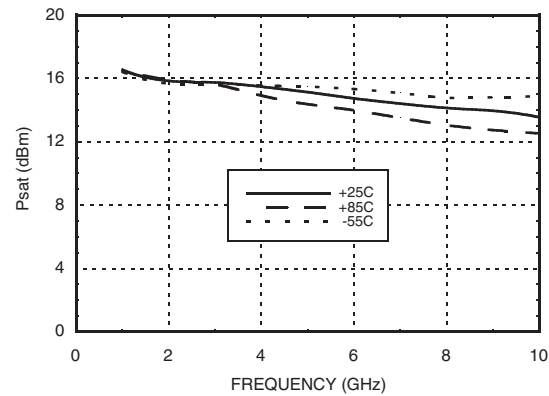

Power Compression @ 1 GHz

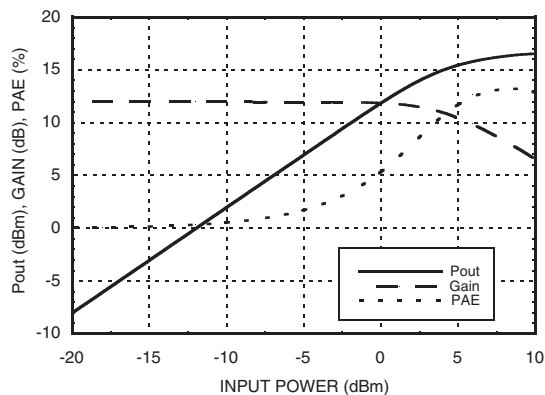

Power Compression @ 8 GHz

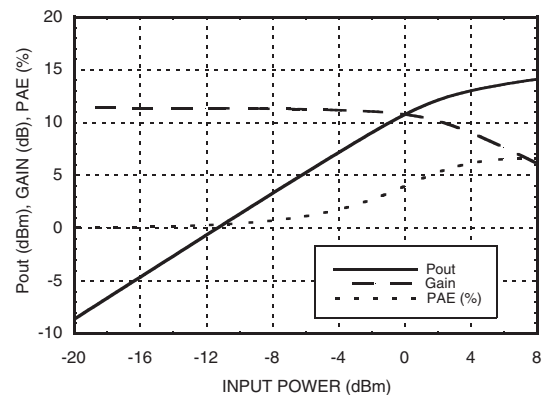

Output IP3 vs. Temperature

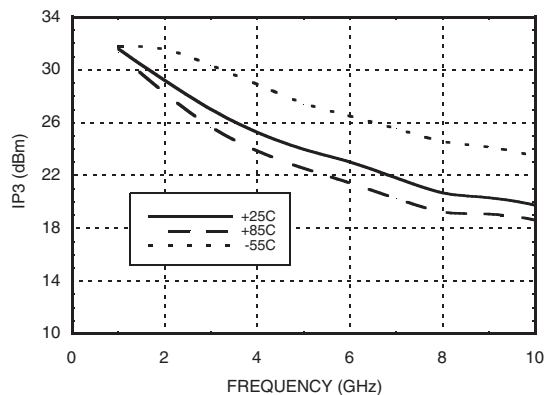

Gain, Power, OIP3 & Supply Current vs. Supply Voltage @ 1 GHz

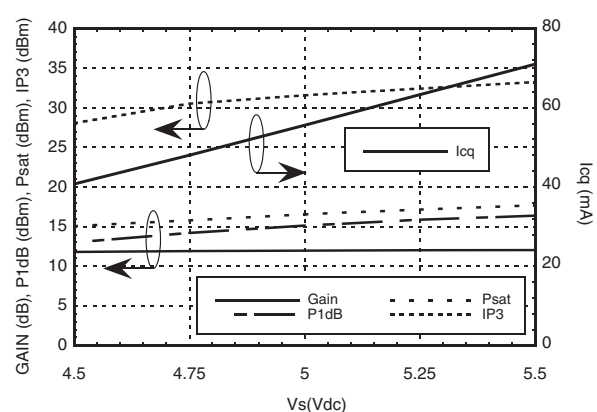

Information furnished by Analog Devices is believed to be accurate and reliable. However, no responsibility is assumed by Analog Devices for its use, nor for any infringements of patents or other rights of third parties that may result from its use. Specifications subject to change without notice. No license is granted by implication or otherwise under any patent or patent rights of Analog Devices. Trademarks and registered trademarks are the property of their respective owners.

For price, delivery, and to place orders: Analog Devices, Inc., One Technology Way, P.O. Box 9106, Norwood, MA 02062-9106 Phone: 781-329-4700 • Order online at www.analog.com Application Support: Phone: 1-800-ANALOG-D

InGaP HBT GAIN BLOCK MMIC AMPLIFIER, DC - 8 GHz

Absolute Maximum Ratings

Collector Bias Voltage (Vcc)	+7 Vdc
RF Input Power (RFIN)(Vcc = +5.0 Vdc)	+10 dBm
Junction Temperature	150 °C
Continuous P _{diss} (T= 85 °C) (derate 5.21 mW/°C above 85 °C)	0.339 W
Thermal Resistance (junction to die bottom)	192 °C/W
Storage Temperature	-65 to +150 °C
Operating Temperature	-55 to +85 °C



**ELECTROSTATIC SENSITIVE DEVICE
OBSERVE HANDLING PRECAUTIONS**

Outline Drawing

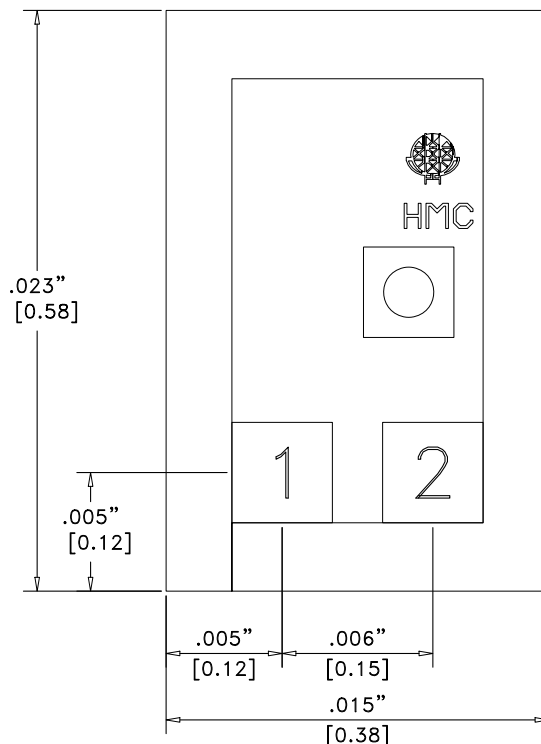

NOTES:

1. ALL DIMENSIONS IN INCHES [MILLIMETERS]
2. ALL TOLERANCES ARE ±0.001 (0.025)
3. DIE THICKNESS IS 0.004 (0.100) BACKSIDE IS GROUND
4. BOND PADS ARE 0.004 (0.100) SQUARE
5. BOND PAD SPACING, CTR-CTR: 0.006 (0.150)
6. BACKSIDE METALLIZATION: GOLD
7. BOND PAD METALLIZATION: GOLD

Die Packaging Information ^[1]

Standard	Alternate
GP-3 (Gel Pack)	[2]

[1] Refer to the "Packaging Information" section for die packaging dimensions.

[2] For alternate packaging information contact Hittite Microwave Corporation.

**InGaP HBT GAIN BLOCK
MMIC AMPLIFIER, DC - 8 GHz**

Pad Descriptions

Pad Number	Function	Description	Interface Schematic
1	RFIN	This pin is DC coupled. An off chip DC blocking capacitor is required.	
2	RFOUT	RF output and DC Bias for the output stage.	
Die Bottom	GND	Die bottom must be connected to RF/DC ground.	

Application Circuit

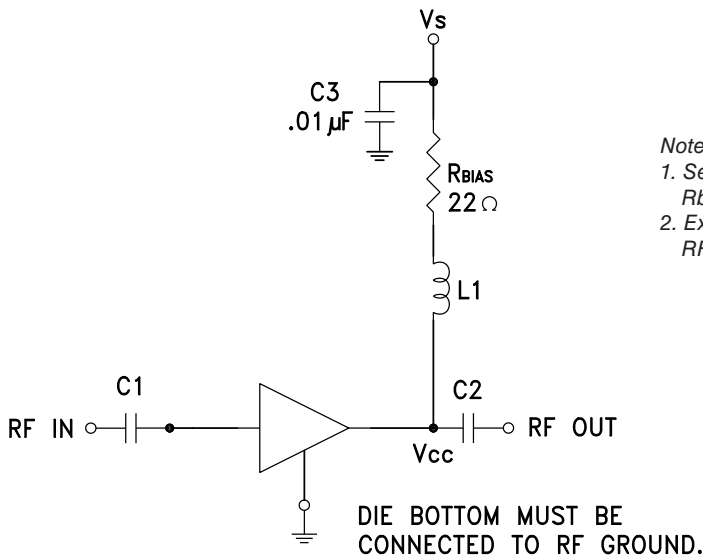

- Note:
1. Select R_{bias} to achieve I_{cq} using equation below, $R_{bias} \geq 22 \text{ Ohm}$.
 2. External blocking capacitors are required on R_{FIN} and R_{FOUT} .

$$I_{cq} = \frac{V_s - 3.9}{R_{bias}}$$

Recommended Component Values

Component	Frequency (MHz)			
	50	1000	4000	8000
L1	270 nH	56 nH	8.2 nH	2.2 nH
C1, C2	0.01 μ F	100 pF	100 pF	100 pF

Information furnished by Analog Devices is believed to be accurate and reliable. However, no responsibility is assumed by Analog Devices for its use, nor for any infringements of patents or other rights of third parties that may result from its use. Specifications subject to change without notice. No license is granted by implication or otherwise under any patent or patent rights of Analog Devices. Trademarks and registered trademarks are the property of their respective owners.

For price, delivery, and to place orders: Analog Devices, Inc., One Technology Way, P.O. Box 9106, Norwood, MA 02062-9106 Phone: 781-329-4700 • Order online at www.analog.com Application Support: Phone: 1-800-ANALOG-D

InGaP HBT GAIN BLOCK MMIC AMPLIFIER, DC - 8 GHz

Assembly Diagram

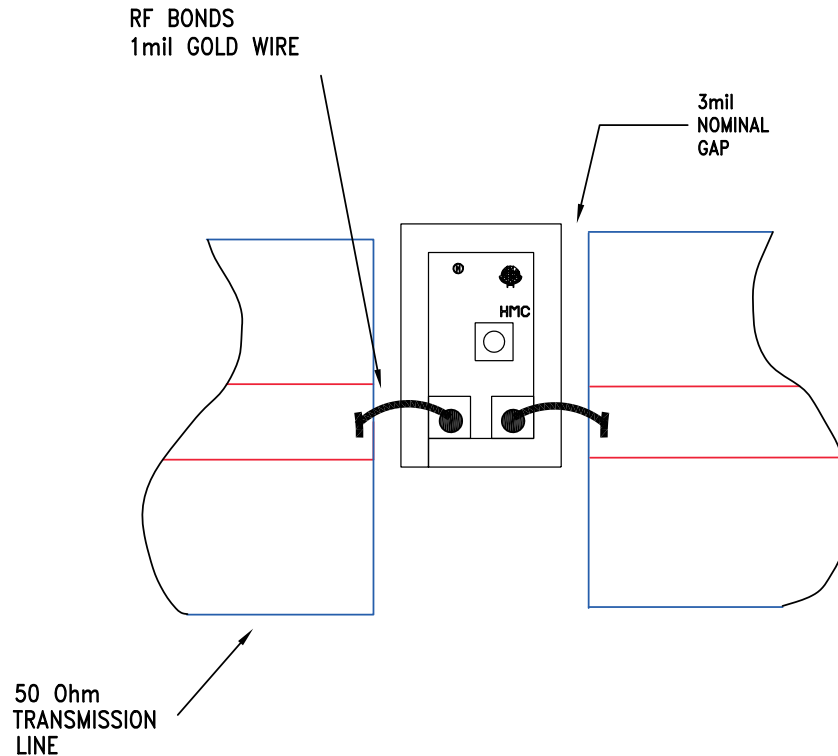

Handling Precautions

Follow these precautions to avoid permanent damage.

Storage: All bare die are placed in either Waffle or Gel based ESD protective containers, and then sealed in an ESD protective bag for shipment. Once the sealed ESD protective bag has been opened, all die should be stored in a dry nitrogen environment.

Cleanliness: Handle the chips in a clean environment. DO NOT attempt to clean the chip using liquid cleaning systems.

Static Sensitivity: Follow ESD precautions to protect against ESD strikes.

Transients: Suppress instrument and bias supply transients while bias is applied. Use shielded signal and bias cables to minimize inductive pick-up.

General Handling: Handle the chip along the edges with a vacuum collet or with a sharp pair of bent tweezers. The surface of the chip has fragile air bridges and should not be touched with vacuum collet, tweezers, or fingers.

Mounting

The chip is back-metallized and can be die mounted with electrically conductive epoxy. The mounting surface should be clean and flat.

Epoxy Die Attach: Apply a minimum amount of epoxy to the mounting surface so that a thin epoxy fillet is observed around the perimeter of the chip once it is placed into position. Cure epoxy per the manufacturer's schedule.

Wire Bonding

Ball or wedge bond with 0.025mm (1 mil) diameter pure gold wire. Thermosonic wirebonding with a nominal stage temperature of 150 deg. C and a ball bonding force of 40 to 50 grams or wedge bonding force of 18 to 22 grams is recommended. Use the minimum level of ultrasonic energy to achieve reliable wirebonds. Wirebonds should be started on the chip and terminated on the package or substrate. All bonds should be as short as possible <0.31mm (12 mils).



Компания «ЭлектроПласт» предлагает заключение долгосрочных отношений при поставках импортных электронных компонентов на взаимовыгодных условиях!

Наши преимущества:

- Оперативные поставки широкого спектра электронных компонентов отечественного и импортного производства напрямую от производителей и с крупнейших мировых складов;
- Поставка более 17-ти миллионов наименований электронных компонентов;
- Поставка сложных, дефицитных, либо снятых с производства позиций;
- Оперативные сроки поставки под заказ (от 5 рабочих дней);
- Экспресс доставка в любую точку России;
- Техническая поддержка проекта, помощь в подборе аналогов, поставка прототипов;
- Система менеджмента качества сертифицирована по Международному стандарту ISO 9001;
- Лицензия ФСБ на осуществление работ с использованием сведений, составляющих государственную тайну;
- Поставка специализированных компонентов (Xilinx, Altera, Analog Devices, Intersil, Interpoint, Microsemi, Aeroflex, Peregrine, Syfer, Eurofarad, Texas Instrument, Miteq, Cobham, E2V, MA-COM, Hittite, Mini-Circuits, General Dynamics и др.);

Помимо этого, одним из направлений компании «ЭлектроПласт» является направление «Источники питания». Мы предлагаем Вам помощь Конструкторского отдела:

- Подбор оптимального решения, техническое обоснование при выборе компонента;
- Подбор аналогов;
- Консультации по применению компонента;
- Поставка образцов и прототипов;
- Техническая поддержка проекта;
- Защита от снятия компонента с производства.



Как с нами связаться

Телефон: 8 (812) 309 58 32 (многоканальный)

Факс: 8 (812) 320-02-42

Электронная почта: org@eplast1.ru

Адрес: 198099, г. Санкт-Петербург, ул. Калинина, дом 2, корпус 4, литера А.