

# THIN FILM CHIP INDUCTORS

ATFC-0402

 RoHS/RoHS II Compliant

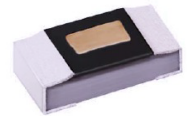

1.00 x 0.50 x 0.32mm

## FEATURES:

- Photolithographic single layer ceramic chip
- High SRF, excellent Q, superior temperature stability
- Tight tolerance  $\pm 0.1\text{nH}$  available
- Self resonant frequency controlled within 10%
- Stable inductance in high frequency circuit
- Highly stable design for critical needs

## APPLICATIONS:

- Cell phones and GPS
- VCO, TCXO Circuit and RF Transceiver Module
- Wireless LAN, Bluetooth Module, Communication Appliances

## STANDARD SPECIFICATIONS:

### PARAMETERS

ABRACON P/N:	ATFC-0402
Operating temperature:	-45°C to +85°C
Storage temperature:	+25 $\pm$ 3°C, 80% RH max

Part Number ATFC-0402- Inductance Code	L(nH)	Tolerance	Q, Min @ 500MHz	SRF Min (GHz)	R <sub>DC</sub> Max ( $\Omega$ )	I <sub>DC</sub> Max (mA)
ATFC-0402-0N2	0.2	B, C, S	13	14	0.10	800
ATFC-0402-0N3	0.3	B, C, S	13	14	0.10	800
ATFC-0402-0N4	0.4	B, C, S	13	14	0.10	800
ATFC-0402-0N5	0.5	B, C, S	13	14	0.15	700
ATFC-0402-0N6	0.6	B, C, S	13	14	0.15	700
ATFC-0402-0N8	0.8	B, C, S	13	14	0.15	700
ATFC-0402-0N9	0.9	B, C, S	13	14	0.15	700
ATFC-0402-1N0	1.0	B, C, S	13	12	0.15	700
ATFC-0402-1N1	1.1	B, C, S	13	12	0.15	700
ATFC-0402-1N2	1.2	B, C, S	13	12	0.15	700
ATFC-0402-1N3	1.3	B, C, S	13	10	0.25	700
ATFC-0402-1N4	1.4	B, C, S	13	10	0.25	700
ATFC-0402-1N5	1.5	B, C, S	13	10	0.25	700
ATFC-0402-1N6	1.6	B, C, S	13	10	0.25	560
ATFC-0402-1N7	1.7	B, C, S	13	10	0.25	560
ATFC-0402-1N8	1.8	B, C, S	13	10	0.25	560
ATFC-0402-1N9	1.9	B, C, S	13	8	0.35	560
ATFC-0402-2N0	2.0	B, C, S	13	8	0.35	560
ATFC-0402-2N1	2.1	B, C, S	13	8	0.35	440
ATFC-0402-2N2	2.2	B, C, S	13	8	0.35	440
ATFC-0402-2N3	2.3	B, C, S	13	8	0.35	440
ATFC-0402-2N4	2.4	B, C, S	13	8	0.35	440
ATFC-0402-2N5	2.5	B, C, S	13	8	0.35	440
ATFC-0402-2N6	2.6	B, C, S	13	8	0.35	440
ATFC-0402-2N7	2.7	B, C, S	13	8	0.35	440
ATFC-0402-2N8	2.8	B, C, S	13	6	0.45	380
ATFC-0402-2N9	2.9	B, C, S	13	6	0.45	380
ATFC-0402-3N0	3.0	B, C, S	13	6	0.45	380
ATFC-0402-3N1	3.1	B, C, S	13	6	0.45	380
ATFC-0402-3N2	3.2	B, C, S	13	6	0.45	380
ATFC-0402-3N3	3.3	B, C, S	13	6	0.45	380
ATFC-0402-3N4	3.4	B, C, S	13	6	0.55	380
ATFC-0402-3N5	3.5	B, C, S	13	6	0.55	380
ATFC-0402-3N6	3.6	B, C, S	13	6	0.55	380
ATFC-0402-3N7	3.7	B, C, S	13	6	0.55	340
ATFC-0402-3N8	3.8	B, C, S	13	6	0.55	340
ATFC-0402-3N9	3.9	B, C, S	13	6	0.55	340
ATFC-0402-4N3	4.3	B, C, S	13	6	0.65	320
ATFC-0402-4N7	4.7	B, C, S	13	6	0.65	320
ATFC-0402-5N4	5.4	B, C, S	13	6	0.85	280
ATFC-0402-5N6	5.6	B, C, S	13	6	0.85	280
ATFC-0402-5N9	5.9	B, C, S	13	6	0.85	280
ATFC-0402-6N5	6.5	B, C, S	13	6	1.05	260
ATFC-0402-6N8	6.8	B, C, S	13	6	1.05	260

ABRACON IS  
ISO 9001 /2008  
CERTIFIED



**ABRACON**  
CORPORATION

Visit [www.abracorn.com](http://www.abracorn.com) for Terms & Conditions of Sale **Revised: 06.17.13**  
30332 Esperanza, Rancho Santa Margarita, California 92688  
tel 949-546-8000 | fax 949-546-800 | [www.abracorn.com](http://www.abracorn.com)

# THIN FILM CHIP INDUCTORS

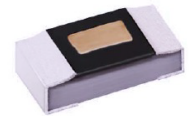

0.60 x 0.30 x 0.23mm

ATFC-0402

RoHS/RoHS II Compliant

## Key Electrical Specifications (Con'd)

Part Number ATFC-0402- Inductance Code	L(nH)	Tolerance	Q, Min @ 500MHz	SRF Min (GHz)	RDC Max ( $\Omega$ )	IDC Max (mA)
ATFC-0402-7N2	7.2	B, C, S	13	6	1.05	260
ATFC-0402-8N0	8.0	B, C, S	13	5.5	1.25	220
ATFC-0402-8N1	8.1	B, C, S	13	5.5	1.25	220
ATFC-0402-8N2	8.2	B, C, S	13	5.5	1.25	220
ATFC-0402-9N1	9.1	B, C, S	13	5.5	1.25	220
ATFC-0402-10N	10.0	F, G, H, J	13	4.5	1.35	200
ATFC-0402-10N8	10.8	F, G, H, J	13	4.5	1.35	200
ATFC-0402-12N	12.0	F, G, H, J	13	3.7	1.55	180
ATFC-0402-13N8	13.8	F, G, H, J	13	3.7	1.75	180
ATFC-0402-15N	15.0	F, G, H, J	13	3.3	1.75	130
ATFC-0402-17N	17.0	F, G, H, J	13	3.1	1.95	100
ATFC-0402-18N	18.0	F, G, H, J	13	3.1	2.15	100
ATFC-0402-20N8	20.8	F, G, H, J	13	2.8	2.55	90
ATFC-0402-22N	22.0	F, G, H, J	13	2.8	2.65	90
ATFC-0402-27N	27.0	F, G, H, J	13	2.5	3.25	75
ATFC-0402-33N	33.0	J	13	2.5	4.50	75

## Test Conditions and Equipments

Inductance (L)

- Test equipment: Agilent4287A+Agilent16196C
- Test frequency: 500MHz

## PART IDENTIFICATION:

ATFC- 0402-   -

**Inductance Code**  
Please refer to the table above

Inductance Tolerance
B: $\pm 0.1\text{nH}$
C: $\pm 0.2\text{nH}$
S: $\pm 0.3\text{nH}$
F: $\pm 1\%$
G: $\pm 2\%$
H: $\pm 3\%$
J: $\pm 5\%$

**Packaging**  
T: Tape and Reel  
(10kpcs reel)

## OUTLINE DIMENSIONS:

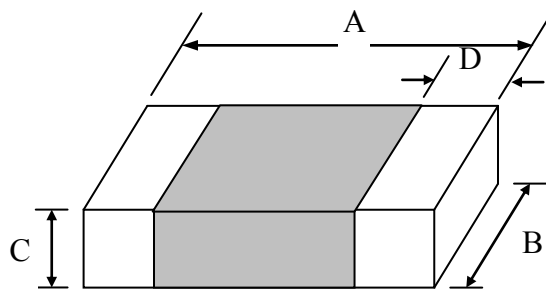

A	B	C	D
1.0 $\pm$ 0.05	0.5 $\pm$ 0.05	0.32 $\pm$ 0.05	0.20 $\pm$ 0.10

## Recommended Land Pattern

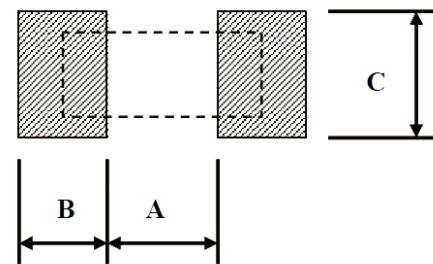

A	B	C
0.50	0.45	0.60 $\pm$ 0.2

Dimension: mm

ABRACON IS  
ISO 9001 /2008  
CERTIFIED



Visit [www.abracon.com](http://www.abracon.com) for Terms & Conditions of Sale  
30332 Esperanza, Rancho Santa Margarita, California 92688  
tel 949-546-8000 | fax 949-546-800 | [www.abracon.com](http://www.abracon.com)

Revised: 06.17.13

# THIN FILM CHIP INDUCTORS



0.60 x 0.30 x 0.23mm

ATFC-0402

RoHS/RoHS II Compliant

## MATERIALS:

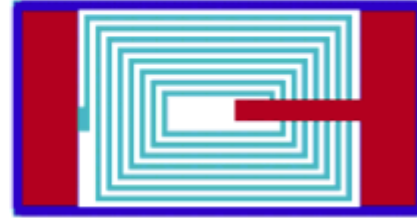
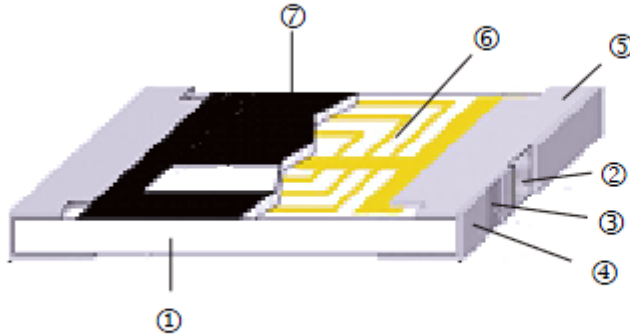

No.	Material
1	Alumina Substrate
2	Inner Electrode (Ni-Cr)
3	Barrier Layer (Ni)
4	External Electrode (Sn)
5	Edge Electrode
6	Cu Circuits
7	Overcoat

## REFLOW PROFILE:

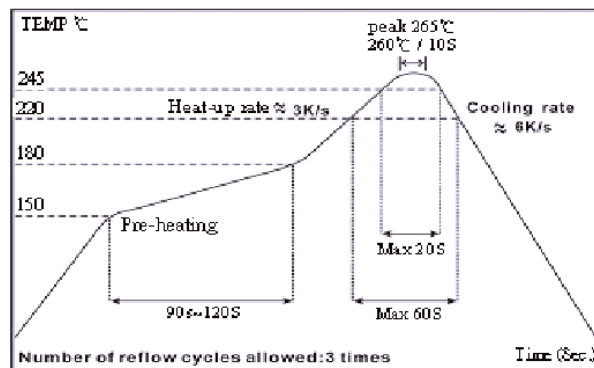

# THIN FILM CHIP INDUCTORS

ATFC-0402

 RoHS/RoHS II Compliant



0.60 x 0.30 x 0.23mm

## TAPE & REEL:

T= tape and reel (10,000pc/reel)

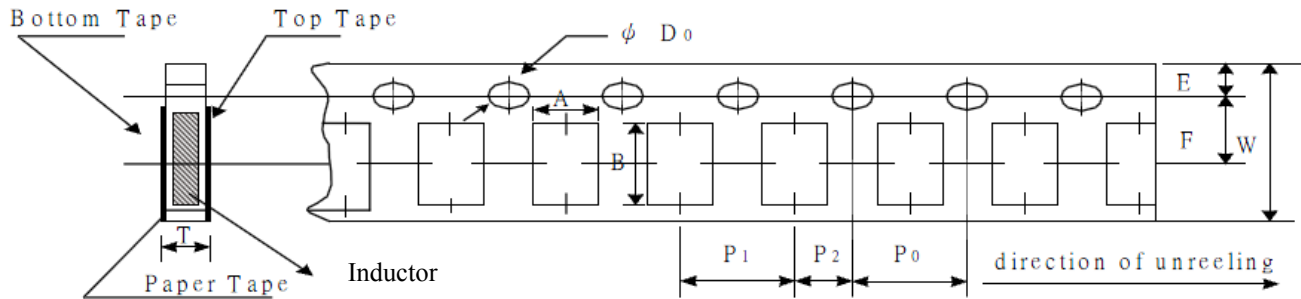

A	B	W	E	F	P0	P1	P2	ϕD0	T
0.70±0.05	1.16±0.05	8.00±0.10	1.75±0.05	3.50±0.05	4.00±0.10	2.00±0.05	2.00±0.05	1.55±0.05	0.40±0.03

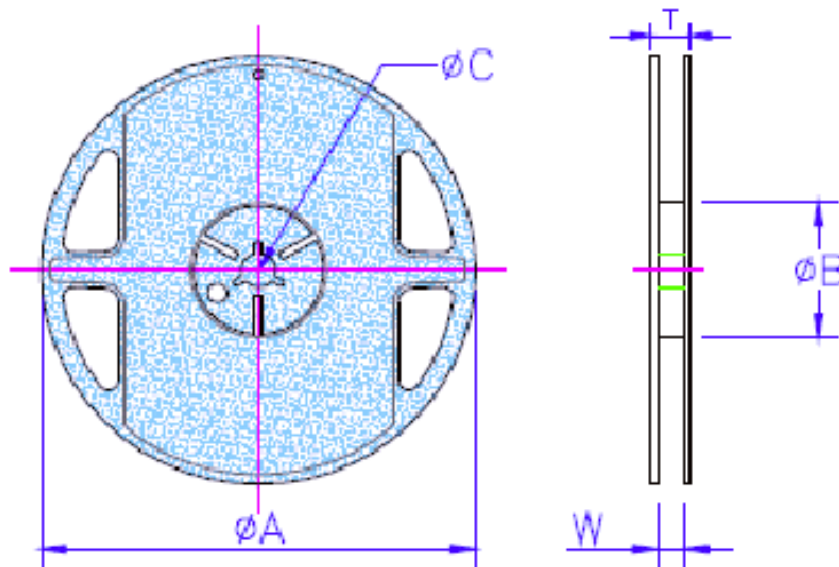

ϕA	ϕB	ϕC	W	T
178.0±1.0	60.0±1.0	13.5±0.7	9.5±1.0	11.5±1.0

Dimension: mm

**ATTENTION:** Abracon Corporation's products are COTS – Commercial-Off-The-Shelf products; suitable for Commercial, Industrial and, where designated, Automotive Applications. Abracon's products are not specifically designed for Military, Aviation, Aerospace, Life-dependant Medical applications or any application requiring high reliability where component failure could result in loss of life and/or property. For applications requiring high reliability and/or presenting an extreme operating environment, written consent and authorization from Abracon Corporation is required. Please contact Abracon Corporation for more information.

ABRACON IS  
ISO 9001 /2008  
CERTIFIED



Visit [www.abracon.com](http://www.abracon.com) for Terms & Conditions of Sale **Revised: 06.17.13**  
30332 Esperanza, Rancho Santa Margarita, California 92688  
tel 949-546-8000 | fax 949-546-800 | [www.abracon.com](http://www.abracon.com)



Компания «ЭлектроПласт» предлагает заключение долгосрочных отношений при поставках импортных электронных компонентов на взаимовыгодных условиях!

Наши преимущества:

- Оперативные поставки широкого спектра электронных компонентов отечественного и импортного производства напрямую от производителей и с крупнейших мировых складов;
- Поставка более 17-ти миллионов наименований электронных компонентов;
- Поставка сложных, дефицитных, либо снятых с производства позиций;
- Оперативные сроки поставки под заказ (от 5 рабочих дней);
- Экспресс доставка в любую точку России;
- Техническая поддержка проекта, помощь в подборе аналогов, поставка прототипов;
- Система менеджмента качества сертифицирована по Международному стандарту ISO 9001;
- Лицензия ФСБ на осуществление работ с использованием сведений, составляющих государственную тайну;
- Поставка специализированных компонентов (Xilinx, Altera, Analog Devices, Intersil, Interpoint, Microsemi, Aeroflex, Peregrine, Syfer, Eurofarad, Texas Instrument, Miteq, Cobham, E2V, MA-COM, Hittite, Mini-Circuits, General Dynamics и др.);

Помимо этого, одним из направлений компании «ЭлектроПласт» является направление «Источники питания». Мы предлагаем Вам помощь Конструкторского отдела:

- Подбор оптимального решения, техническое обоснование при выборе компонента;
- Подбор аналогов;
- Консультации по применению компонента;
- Поставка образцов и прототипов;
- Техническая поддержка проекта;
- Защита от снятия компонента с производства.



#### Как с нами связаться

**Телефон:** 8 (812) 309 58 32 (многоканальный)

**Факс:** 8 (812) 320-02-42

**Электронная почта:** [org@eplast1.ru](mailto:org@eplast1.ru)

**Адрес:** 198099, г. Санкт-Петербург, ул. Калинина, дом 2, корпус 4, литера А.