

DATA SHEET
SE2574L: 2.4 GHz High Efficiency Wireless LAN PA

Applications

- IEEE802.11b DSSS WLAN
- IEEE802.11g OFDM WLAN
- Embedded, SiP modules

Features

- Dual Mode IEEE802.11b & IEEE802.11g
- Integrated PA, digital bias control, 50Ω input and output match, 3.2GHz TX Filter.
- Integrated harmonic filter.
- Integrated load insensitive Power Detector, with <1dB error at 2:1 mismatch
- 20 dBm Output Power, 802.11b, 11 Mbps, ACPR <-30 dBc
- 18dBm @ 3.0 % EVM, 802.11g, 54 Mbps
- 2.3 V to 5.0 V direct to battery supply
- Lead free, Halogen free, ROHS compliant , 2 x2x0.9 mm QFN package, MSL 1

Product Description

The SE2574L is a complete 802.11 b/g WLAN discrete power amplifier. The device provides all the functionality of the power amplifier, power detector, filter, associated input, inter-stage and output matching in an ultra compact 2mm x 2mm x 0.9mm form factor.

The SE2574L is designed for ease of use, with all the critical input and output matching integrated. The SE2574L includes a transmitter power detector with 20 dB of dynamic range and a digital Enable for power on/off control. Harmonic filters and an input 3.2GHz LO rejection filter are integrated on-chip. The power ramp rise/fall time is 0.7 μs typical.

Ordering Information

Part No.	Package	Remark
SE2574L	8 pin QFN	Samples
SE2574L-R	8 pin QFN	Tape and Reel
SE2574L-EK1	N/A	Evaluation kit

Functional Block Diagram

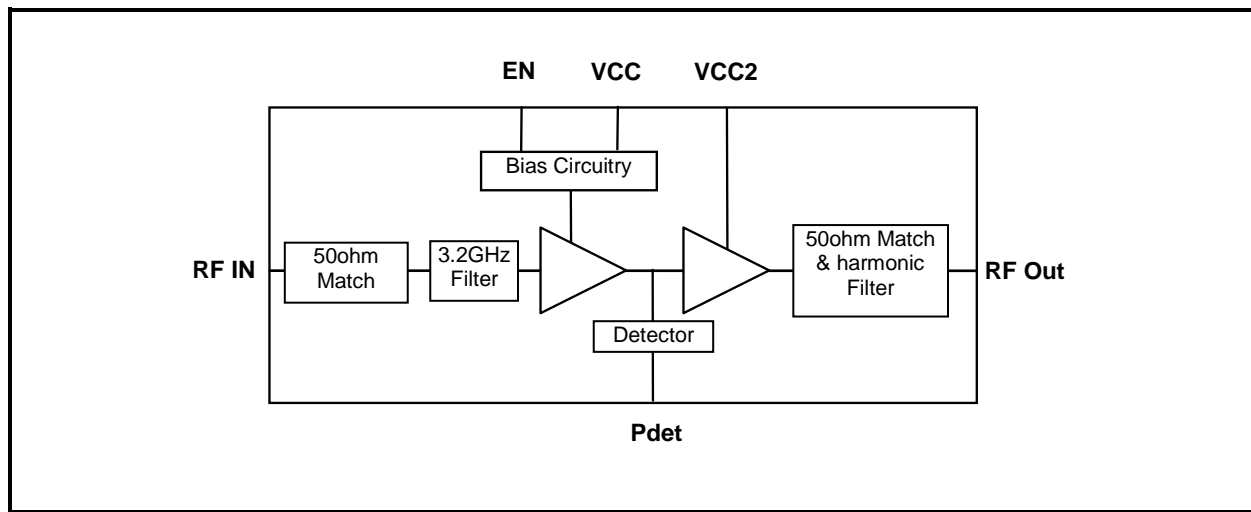

Figure 1: Functional Block Diagram

DATA SHEET
SE2574L: 2.4 GHz High Efficiency Wireless LAN PA

Pin Out Diagram

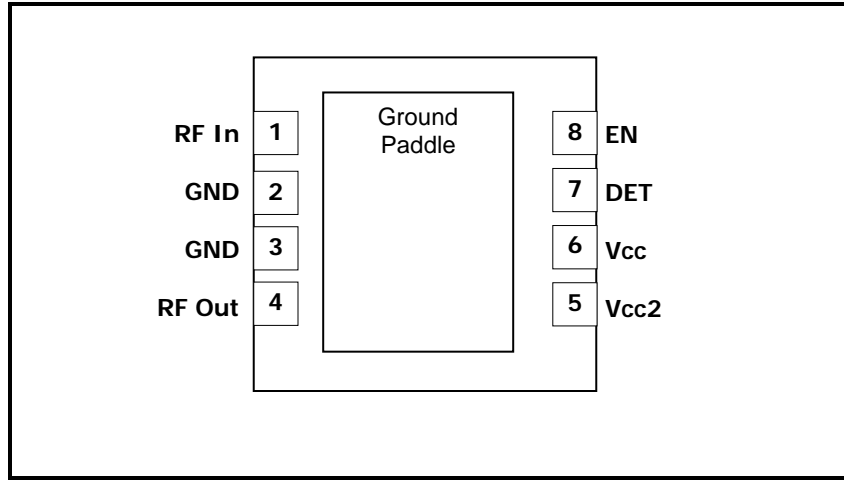

Figure 2: SE2574L Pin Out (Top View Through Package)

Pin Out Description

Pin No.	Name	Description
1	RF In	RF Input (No DC voltage on the pin, but DC short to ground)
2	GND	Ground
3	GND	Ground
4	RF Out	RF Output (No DC voltage on the pin, DC open to ground)
5	VCC2	Final Stage Supply Voltage (May attach directly to battery)
6	VCC	First Stage Supply Voltage (May attach directly to battery)
7	DET	Power Detector Output
8	EN	Power Amplifier Enable
Die paddle	GND	Ground

DATA SHEET
SE2574L: 2.4 GHz High Efficiency Wireless LAN PA

Absolute Maximum Ratings

These are stress ratings only. Exposure to stresses beyond these maximum ratings may cause permanent damage to, or affect the reliability of the device. Avoid operating the device outside the recommended operating conditions defined below. This device is ESD sensitive. Handling and assembly of this device should be at ESD protected workstations.

Symbol	Definition	Min.	Max.	Unit
VCC	Supply Voltage on VCC	-0.3	5.5	V
EN	DC input on EN	-0.3	4.0	V
TX	RF Input Power. ANT terminated in 50Ω match	-	12.0	dBm
T _A	Operating Temperature Range	-40	85	°C
T _{STG}	Storage Temperature Range	-40	150	°C
ESD _{HBM}	JEDEC JESD22-A114 all pins	-	500	V

Recommended Operating Conditions

Symbol	Parameter	Min.	Typ.	Max.	Unit
T _A	Ambient temperature	-40	25	85	°C
VCC	Supply voltage, nominal operation	2.7	3.3	5.0	V
	Supply voltage, output power reduced by 2dB typ	2.3	2.7	-	

DC Electrical Characteristics

Conditions: VCC = 3.3V (default) or VCC = 5.0V (as noted), EN = 3.3V, T_A = 25 °C, as measured on Skyworks Solutions' SE2574L-EK1 evaluation board, all unused ports terminated with 50 ohms, unless otherwise noted.

Symbol	Parameter	Conditions	Min.	Typ.	Max.	Unit
I _{CC-G}	Total Supply Current	54 Mbps OFDM signal, 64QAM 18dBm, VCC = 3.3V 20.5dBm, VCC = 5.0V	-	135 150	-	mA
I _{CC-N}	Total Supply Current	802.11n, MCS7 17dBm, VCC = 3.3V 19dBm, VCC = 5.0V	-	115 130	-	mA
I _{CC-B}	Total Supply Current	11 Mbps CCK signal, BT = 0.45 20dBm, VCC = 3.3V 22dBm, VCC = 5.0V	-	160 175	-	mA
I _{CQ}	Total Supply Current	No RF VCC = 3.3V VCC = 5V	-	90 100	-	mA
I _{CC_OFF}	Total Supply Current	EN = 0 V, No RF Applied	-	1	10	μA

DATA SHEET
SE2574L: 2.4 GHz High Efficiency Wireless LAN PA

Logic Characteristics

Conditions: VCC = 3.3V (default) or VCC = 5.0V (as noted), EN = 3.3V, TA = 25 °C, as measured on Skyworks Solutions' SE2574L-EK1 evaluation board, all unused ports terminated with 50 ohms, unless otherwise noted.

Symbol	Parameter	Conditions	Min.	Typ.	Max.	Unit
V _{ENH}	Logic High Voltage (Module On)	-	1.8	-	3.6	V
V _{ENL}	Logic Low Voltage (Module Off)	-	0	-	0.4	V
I _{ENH}	Input Current Logic High Voltage	-	-	2	10	μA
I _{ENL}	Input Current Logic Low Voltage	-	-	2	10	μA

DATA SHEET
SE2574L: 2.4 GHz High Efficiency Wireless LAN PA

AC Electrical Characteristics

802.11g/n Transmit Characteristics

Conditions: VCC = 3.3V (default) or VCC = 5.0V (as noted), EN = 3.3V, TA = 25 °C, as measured on Skyworks Solutions' SE2574L-EK1 evaluation board, all unused ports terminated with 50 ohms, unless otherwise noted.

Symbol	Parameter	Condition	Min.	Typ.	Max.	Unit	
F _{IN}	Frequency Range	-	2400	-	2500	MHz	
P _{out}	Output Power, 3.3V	54Mbps, OFDM, 64 QAM, EVM = 3%	-	18	-	dBm	
		11Mbps, CCK, BT = 0.45, Mask	-	20	-		
		802.11n, HT20, all data rates, Mask	-	22	-		
		802.11n, HT40, all data rates, Mask	-	20	-		
	Output Power, 5.0V	54Mbps, OFDM, 64 QAM, EVM = 3%	-	20.5	-		
		11Mbps, CCK, BT = 0.45, Mask	-	22	-		
		802.11n, HT20, all data rates, Mask	-	24	-		
		802.11n, HT40, all data rates, Mask	-	22	-		
P _{1dB}	P1dB	-	-	25.0	-	dBm	
S ₂₁	Small Signal Gain	-	25	28	29	dB	
ΔS ₂₁	Small Signal Gain Variation	Gain variation over single 20MHz channel	-	0.5	-	dB	
		Gain Variation over band	-	-	1.1		
S ₂₁ 3.2	Gain @ limit at Ref-vco spur frequency	3206 to 3312 MHz	-	-	15	dB	
2f	Harmonics	1 Mbps, BPSK,	20dBm, 3.3V	-	-50	-45	dBm/MHz
3f			22dBm, 5.0V	-	-50	-45	
				-48	-43		
t _{dr} , t _{df}	Delay & rise/fall Time	50 % of V _{EN} edge and 90/10 % of final output power level	-	0.7	-	μs	
S ₁₁	Input Return Loss	-	7	10	-	dB	
STAB	Stability	CW, P _{OUT} = 20 dBm, VCC = 3.3V 0.1 GHz – 20 GHz Load VSWR = 10:1	All non-harmonically related outputs less than -42 dBm/MHz				
RU	Ruggedness	P _{IN} = 12dBm, VCC = 3.3V Load VSWR = 10:1	No permanent damage				

DATA SHEET
SE2574L: 2.4 GHz High Efficiency Wireless LAN PA

Power Detector Characteristics

Conditions: VCC = 3.3V (default) or VCC = 5.0V (as noted), EN = 3.3V, TA = 25 °C, as measured on Skyworks Solutions' SE2574L-EK1 evaluation board, all unused ports terminated with 50 ohms, unless otherwise noted.

Symbol	Parameter	Condition	VCC = 3.3V			VCC = 5V			Unit
			Min.	Typ.	Max.	Min.	Typ.	Max.	
F _{OUT}	Frequency Range	-	2400	-	2500	2400	-	2500	MHz
PDR	Power detect range, CW	Measured at ANT	0	-	23	0	-	23	dBm
PDZ _{src}	DC source impedance on PD_OUT	-	-	1	-	-	1	-	k Ω
PDV _{NoRF}	Output Voltage, P _{OUT} = No RF	Measured into 1MΩ	-	0.12	-	-	0.12	-	V
PDV _{p18}	Output Voltage, P _{OUT} = 18 dBm CW	Measured into 1MΩ	-	0.60	-	-	0.55	-	V
PDV _{p20}	Output Voltage, P _{OUT} = 20 dBm CW	Measured into 1MΩ	-	0.75	-	-	0.70	-	V
PDV _{p23}	Output Voltage, P _{OUT} = 23 dBm CW	Measured into 1MΩ	-	NA	-	-	1.00	-	V
LPF _{-3dB}	Power detect low pass filter -3dB corner frequency	Measured into 1MΩ	260	290	400	270	290	400	kHz

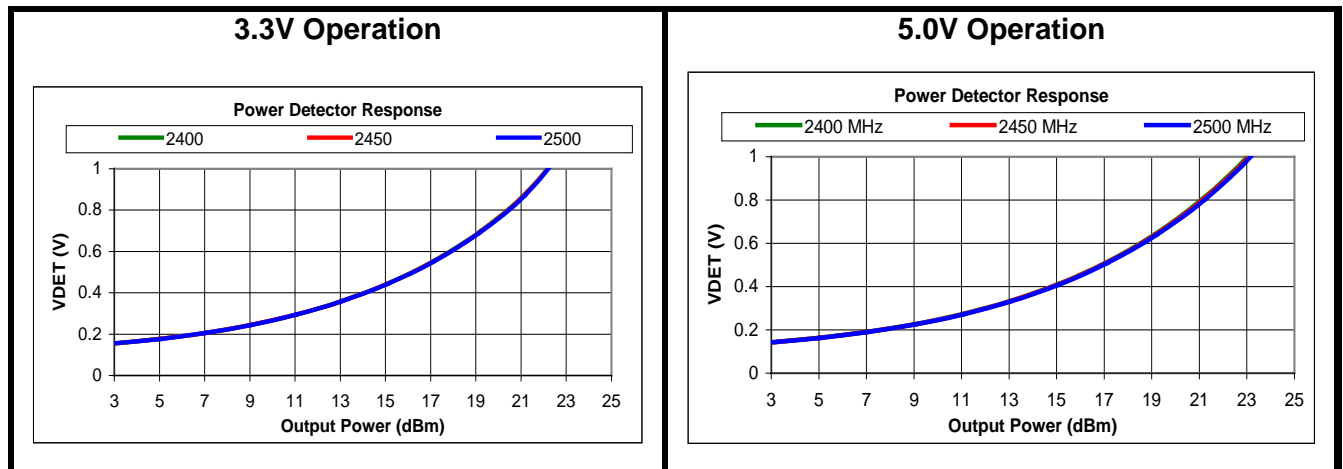

Figure 3: SE2574L Power Detector Characteristics

DATA SHEET
SE2574L: 2.4 GHz High Efficiency Wireless LAN PA

Package Diagram

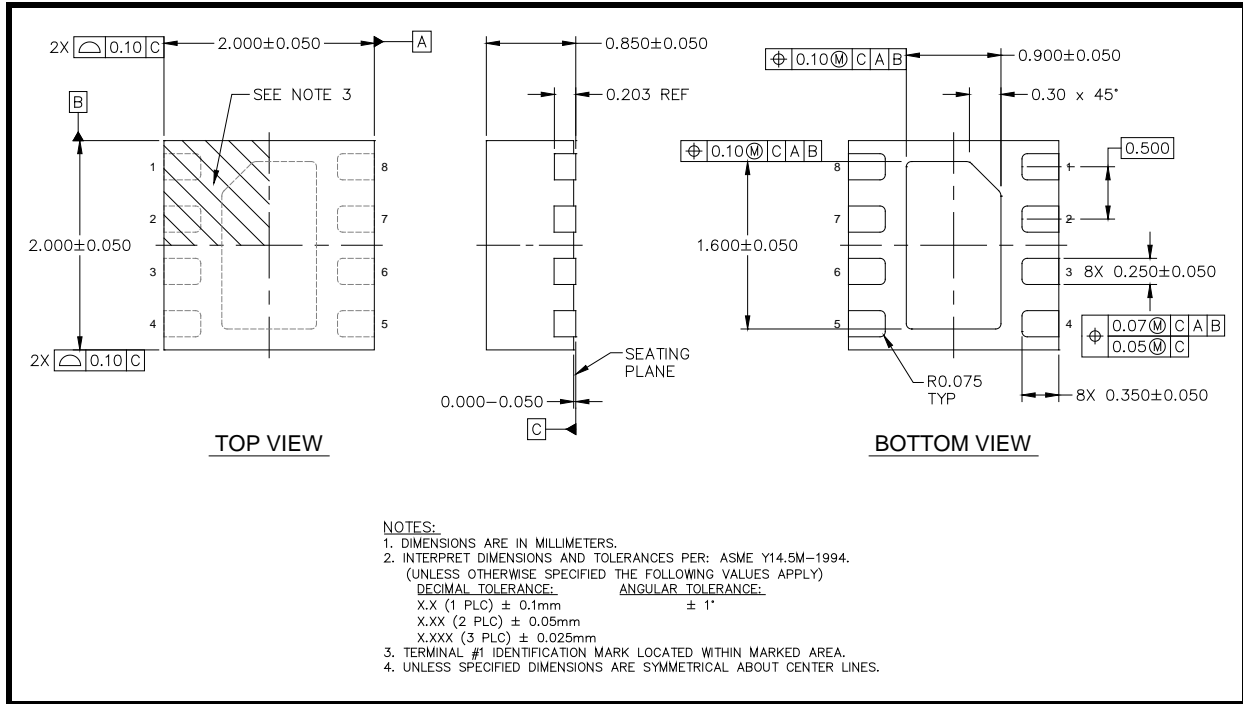

Figure 4: SE2574L Package Diagram

Recommended Land Pattern

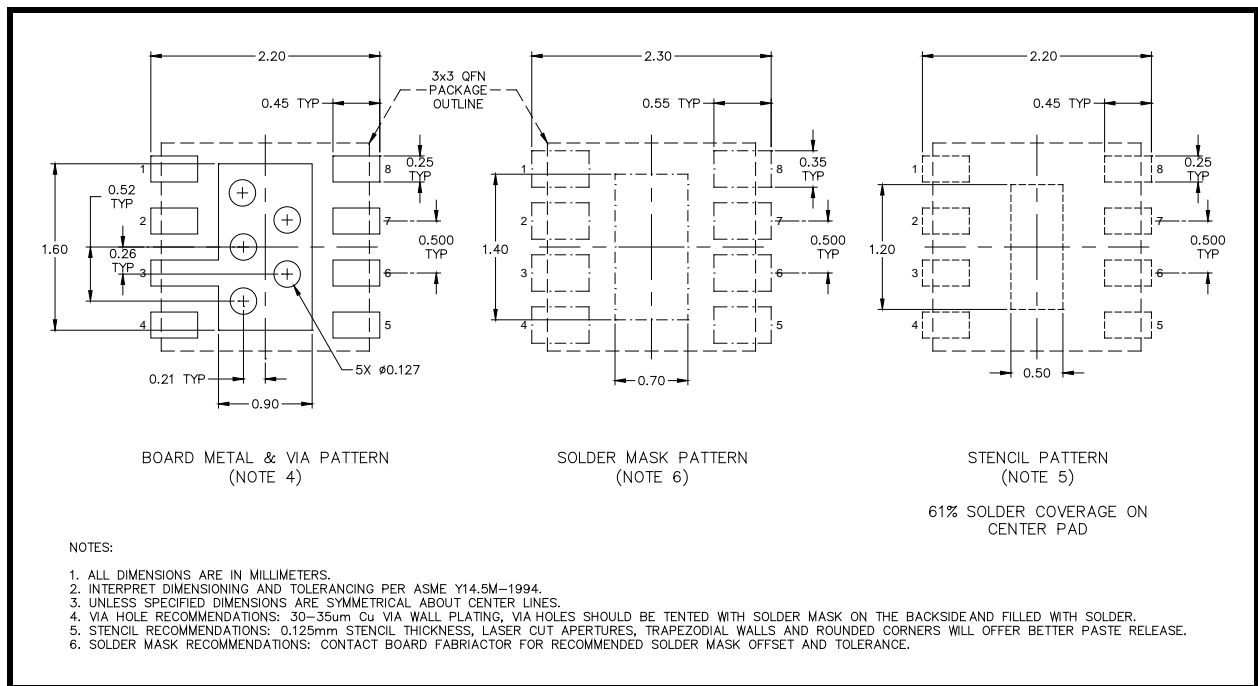

Figure 5: SE2574L Package Diagram

Branding Information

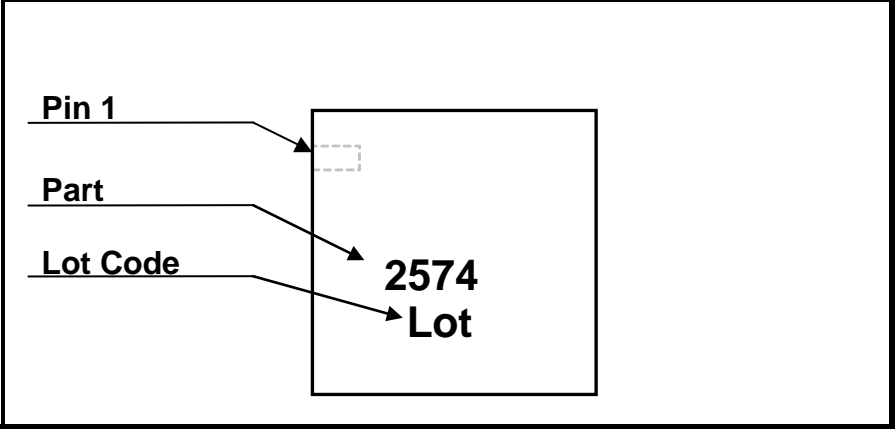

Figure 6: SE2574L Branding and Pin 1 Location (Top View)

DATA SHEET
SE2574L: 2.4 GHz High Efficiency Wireless LAN PA

Package Handling Information

Because of its sensitivity to moisture absorption, instructions on the shipping container label must be followed regarding exposure to moisture after the container seal is broken, otherwise, problems related to moisture absorption may occur when the part is subjected to high temperature during solder assembly. The SE2574L is capable of withstanding a Pb free solder reflow. Care must be taken when attaching this product, whether it is done manually or in a production solder reflow environment. If the part is manually attached, precaution should be taken to insure that the device is not subjected to temperatures above its rated peak temperature for an extended period of time. For details on both attachment techniques, precautions, and handling procedures recommended, please refer to:

- “QFN solder reflow and rework information application note”, Document Number QAD-00045
- “Handling, packing, shipping and use of moisture sensitive QFN application note”, Document Number QAD-00044



Caution! Class 1B ESD sensitive device

Tape and Reel Information

Parameter	Value
Devices Per Reel	3000
Reel Diameter	7 inches
Tape Width	12 millimeters

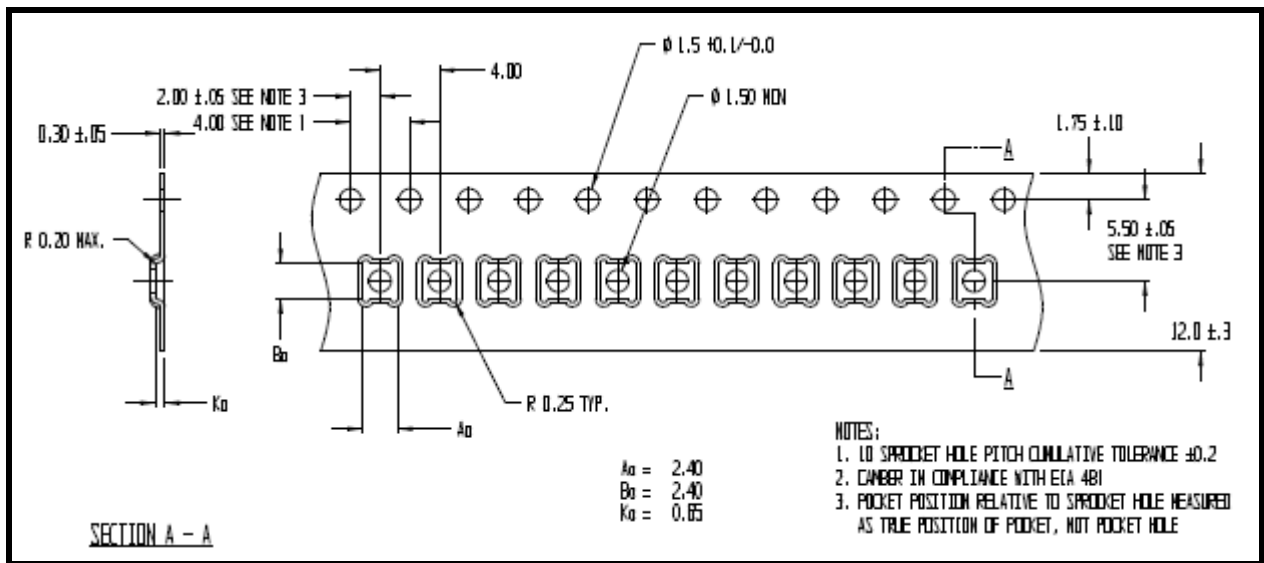

Figure 8: SE2574L-R Tape and Reel Information



DATA SHEET
SE2574L: 2.4 GHz High Efficiency Wireless LAN PA

Document Change History

Revision	Date	Notes
1.0	12/4/2009	Created
1.1	4/30/2010	Updated Package Marking Diagram
1.2	6/10/2010	Updated tape and reel information
1.3	6/22/2010	Updated gain specification MIN limit from 25dB to 24dB
1.4	11/01/2010	Updated ESD specification.
1.5	12/18/2010	Added 802.11n Mask Compliant Power Rating
1.6	1/31/2011	Added 802.11N to ICC table
1.7	4/10/2012	Updated with Skyworks logo and disclaimer statement

Copyright © 2012 Skyworks Solutions, Inc. All Rights Reserved.

Information in this document is provided in connection with Skyworks Solutions, Inc. ("Skyworks") products or services. These materials, including the information contained herein, are provided by Skyworks as a service to its customers and may be used for informational purposes only by the customer. Skyworks assumes no responsibility for errors or omissions in these materials or the information contained herein. Skyworks may change its documentation, products, services, specifications or product descriptions at any time, without notice. Skyworks makes no commitment to update the materials or information and shall have no responsibility whatsoever for conflicts, incompatibilities, or other difficulties arising from any future changes.

No license, whether express, implied, by estoppel or otherwise, is granted to any intellectual property rights by this document. Skyworks assumes no liability for any materials, products or information provided hereunder, including the sale, distribution, reproduction or use of Skyworks products, information or materials, except as may be provided in Skyworks Terms and Conditions of Sale.

THE MATERIALS, PRODUCTS AND INFORMATION ARE PROVIDED "AS IS" WITHOUT WARRANTY OF ANY KIND, WHETHER EXPRESS, IMPLIED, STATUTORY, OR OTHERWISE, INCLUDING FITNESS FOR A PARTICULAR PURPOSE OR USE, MERCHANTABILITY, PERFORMANCE, QUALITY OR NON-INFRINGEMENT OF ANY INTELLECTUAL PROPERTY RIGHT; ALL SUCH WARRANTIES ARE HEREBY EXPRESSLY DISCLAIMED. SKYWORKS DOES NOT WARRANT THE ACCURACY OR COMPLETENESS OF THE INFORMATION, TEXT, GRAPHICS OR OTHER ITEMS CONTAINED WITHIN THESE MATERIALS. SKYWORKS SHALL NOT BE LIABLE FOR ANY DAMAGES, INCLUDING BUT NOT LIMITED TO ANY SPECIAL, INDIRECT, INCIDENTAL, STATUTORY, OR CONSEQUENTIAL DAMAGES, INCLUDING WITHOUT LIMITATION, LOST REVENUES OR LOST PROFITS THAT MAY RESULT FROM THE USE OF THE MATERIALS OR INFORMATION, WHETHER OR NOT THE RECIPIENT OF MATERIALS HAS BEEN ADVISED OF THE POSSIBILITY OF SUCH DAMAGE.

Skyworks products are not intended for use in medical, lifesaving or life-sustaining applications, or other equipment in which the failure of the Skyworks products could lead to personal injury, death, physical or environmental damage. Skyworks customers using or selling Skyworks products for use in such applications do so at their own risk and agree to fully indemnify Skyworks for any damages resulting from such improper use or sale.

Customers are responsible for their products and applications using Skyworks products, which may deviate from published specifications as a result of design defects, errors, or operation of products outside of published parameters or design specifications. Customers should include design and operating safeguards to minimize these and other risks. Skyworks assumes no liability for applications assistance, customer product design, or damage to any equipment resulting from the use of Skyworks products outside of stated published specifications or parameters.

Skyworks, the Skyworks symbol, and "Breakthrough Simplicity" are trademarks or registered trademarks of Skyworks Solutions, Inc., in the United States and other countries. Third-party brands and names are for identification purposes only, and are the property of their respective owners. Additional information, including relevant terms and conditions, posted at www.skyworksinc.com, are incorporated by reference.



Компания «ЭлектроПласт» предлагает заключение долгосрочных отношений при поставках импортных электронных компонентов на взаимовыгодных условиях!

Наши преимущества:

- Оперативные поставки широкого спектра электронных компонентов отечественного и импортного производства напрямую от производителей и с крупнейших мировых складов;
- Поставка более 17-ти миллионов наименований электронных компонентов;
- Поставка сложных, дефицитных, либо снятых с производства позиций;
- Оперативные сроки поставки под заказ (от 5 рабочих дней);
- Экспресс доставка в любую точку России;
- Техническая поддержка проекта, помощь в подборе аналогов, поставка прототипов;
- Система менеджмента качества сертифицирована по Международному стандарту ISO 9001;
- Лицензия ФСБ на осуществление работ с использованием сведений, составляющих государственную тайну;
- Поставка специализированных компонентов (Xilinx, Altera, Analog Devices, Intersil, Interpoint, Microsemi, Aeroflex, Peregrine, Syfer, Eurofarad, Texas Instrument, Miteq, Cobham, E2V, MA-COM, Hittite, Mini-Circuits, General Dynamics и др.);

Помимо этого, одним из направлений компании «ЭлектроПласт» является направление «Источники питания». Мы предлагаем Вам помощь Конструкторского отдела:

- Подбор оптимального решения, техническое обоснование при выборе компонента;
- Подбор аналогов;
- Консультации по применению компонента;
- Поставка образцов и прототипов;
- Техническая поддержка проекта;
- Защита от снятия компонента с производства.



Как с нами связаться

Телефон: 8 (812) 309 58 32 (многоканальный)

Факс: 8 (812) 320-02-42

Электронная почта: org@eplast1.ru

Адрес: 198099, г. Санкт-Петербург, ул. Калинина, дом 2, корпус 4, литера А.