

Toggle Switches, A Series, Part Number Matrix

"A" SERIES DESIGN FEATURES

- Toggle – Machined brass, heavy nickel plated.
- Bushing & Frame – Rigid one-piece die cast, copper flashed, heavy nickel plated.
- Fixed Contact – Welded construction.
- Terminal Seal – Epoxy sealing of terminals is standard.

MATERIAL SPECIFICATIONS:

ContactsGold/gold flash
 Silver/tin lead
 Case MaterialThermoset
 Terminal SealEpoxy

TYPICAL PERFORMANCE CHARACTERISTICS:

Contact RatingSilver: 2 A @ 250 VAC or 5 A @ 125 VAC
 Silver: 2 A @ 30 VDC
 Gold: 0.4 VA @ 20 VAC/DC max.
 Insulation Resistance1,000 Megohms min. @ 500 VDC.
 Dielectric Strength1,000 Volts RMS @ sea level initial
 Electrical LifeUp to 30,000 Cycles

ENVIRONMENTAL SPECIFICATIONS

Operating Temperature.....-4°F to + 185°F (-20°C to + 85°C)
 Storage Temperature.....-49°F to + 212°F (-45°C to + 100°C)
 Note: Hardware included with switch

Gemini Series

DESIGN

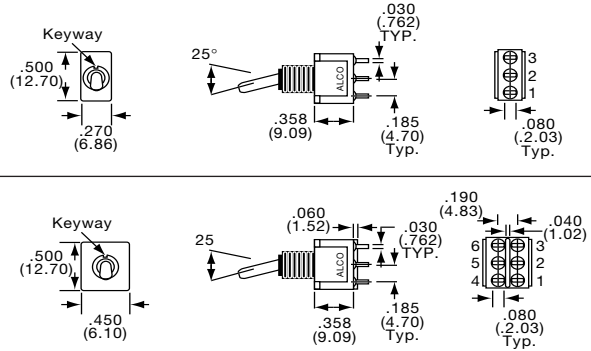
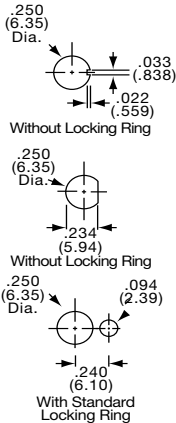
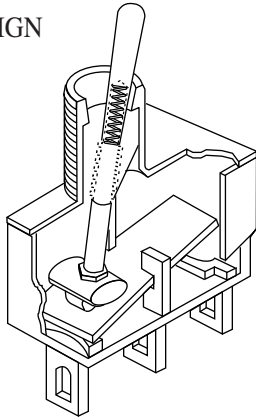

PART NUMBERING

| Model | Function | Toggle | Bushing | Terminal | Contact | K, K1: Cap Color | Option |
|-------------------------|-----------------------|---|--|---------------------------------|-------------------------------------|------------------|---------------------------|
| A1 Single Pole | | S Bat. Long | | Z Wire Lug | Q Silver | 0 Black | |
| A2 Double Pole | | K Locking | | A Right Angle | B Gold | 2 Red | |
| 01 On-On | | K1 Locking | | AV2 Vertical Right Angle | G Gold over Silver | | |
| 03 On-Off-On | | M Bat. Short | | C Printed Circuit | V30 V40 V90 Vertical Support | | U.L.(Q or G contact only) |
| 05 (On)-Off-(On) | | P3 Flatted (with Y only) | | W Wire Wrap | | | |
| 07 On-Off-(On) | | P4 Flatted (with Y only) | | Z3 Quick Connect | | | |
| 08 On-(On) | | T Large Toggle | | | | | |
| 11 On-On-On | double pole case only | T1 Large Toggle & Bushing (15/32) | Y 1/4-40 threaded, .35" long, slotted | | | | |
| 13 On-On-(On) | | T1 Large Toggle & Bushing (15/32) | Y9 unthreaded, .35" long | | | | |
| 15 (On)-On-(On) | | T2P Large Flatted Toggle and Bushing (15/32) | CW 1/4-40 threaded, .37" long, actuator & bushing flange environmental seals S & M Toggles only | | | | |
| | | | D 1/4-40 threaded, .28" long, slotted | | | | |
| | | | D9 Unthreaded, .28" long | | | | |
| | | | H 1/4-40 threaded, flanged, .30" long | | | | |

See page C23 for SP3T wiring diagram.

Note: For surface mount termination, use the "TST" series, Page C7

Other Options

N Black finish toggle, bushing and hardware. Add "N" to end of part number, but before U.L. option.

O Internal O-ring environmental actuator seal. Add letter after toggle option: S & M.

P Anti-Push-In/Anti rotate. Add letter after toggle S & M.

Toggle Switches, A Series, Options

FUNCTIONS

The following functions available in SP or DP.

| | | | | | | |
|--------------------------|-------------|--|--|------|--|--|
| 01 | 2 Positions | None indicates no mechanical position | | None | | |
| 03 | 3 Positions | Off indicates a mechanical position with no electrical connection. | | Off | | |
| 05 | 3 Positions | (On) indicates momentary action. | | Off | | |
| 07 | 3 Positions | | | Off | | |
| 08 | 2 Positions | | | None | | |
| SPDT, connect terminals: | | | | | | |
| DPDT, connect terminals: | | | | | | |

| | | | | | |
|-----------|-------------|--|--|--|--|
| 11 | 3 Positions | | | | |
| 13 | 3 Positions | | | | |
| 15 | 3 Positions | | | | |

Functions available in DP case only

Connect terminals:

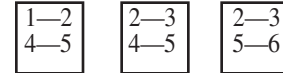

* SP3T functions achieved with external jumper installed by customer

WIRING DIAGRAM FOR FUNCTIONS

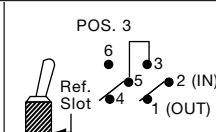
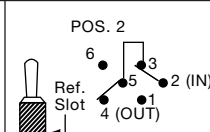
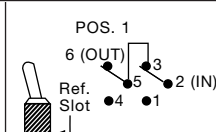
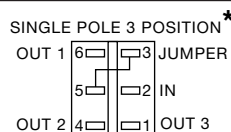
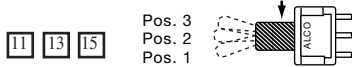

TOGGLES

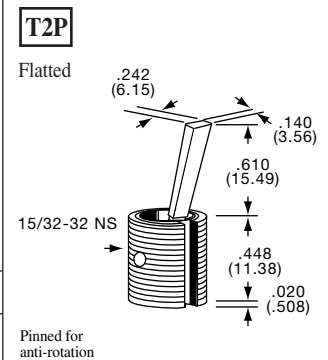
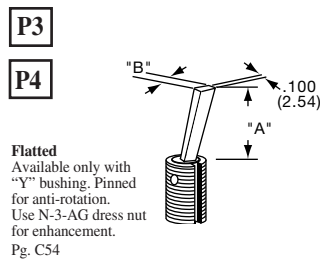
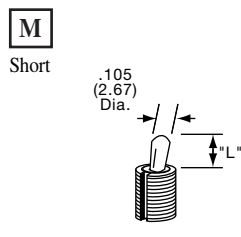
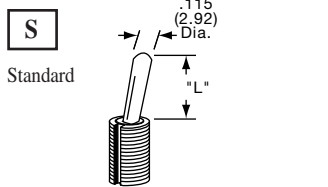

| Dimension "L" | Bushing |
|---------------|----------------|
| .410 (10.41) | "Y", "H", "CW" |
| .480 (12.19) | "D", "D9" |

| Dimension "L" | Bushing Type |
|---------------|----------------|
| .200 (5.08) | "Y", "H", "CW" |
| .270 (6.86) | "D", "D9" |

| Actuator | "A" Dimension "B" | |
|----------|-------------------|-------------|
| P3 | .450 (11.43) | .200 (5.08) |
| P4 | .250 (6.35) | .165 (4.19) |

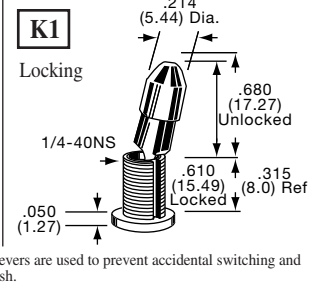
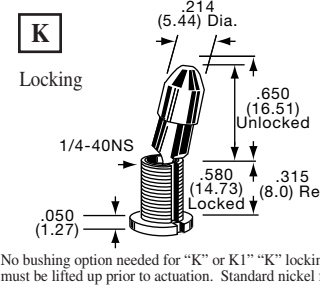
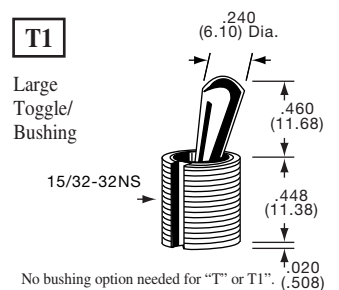
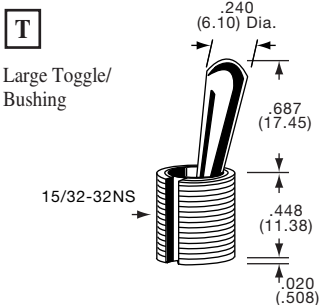

Toggle Switches, A Series, Options

BUSHINGS

Y

1/4-40 Thread
.35" long, slotted
(Standard)

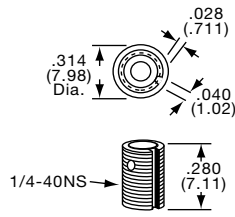

D9

Unthreaded
.28" long

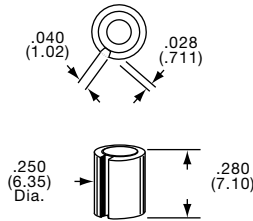

Used with
Z, C & W
terminations

H

1/4-40 Thread
Flanged, .30" long

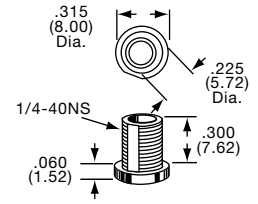

D

1/4-40 Thread
.28" long, slotted

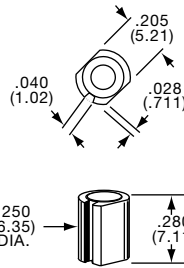
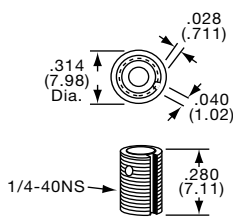

Used with
A, AV2, V30
V80 & V90
terminations

CW

Threaded
Splashproof

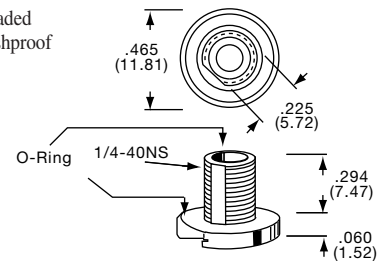

For S & M Toggles

TERMINALS

Z

Wire Lug

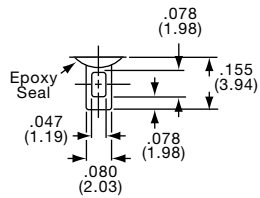

Z3

Quick Connect

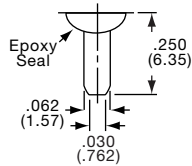

Mates with Tyco
61454 or 60900.

W

Wire Wrap

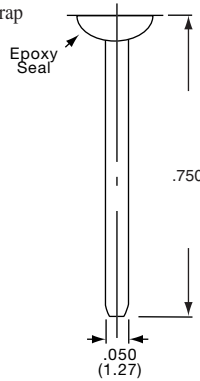

C

Printed Circuit

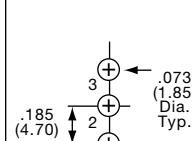
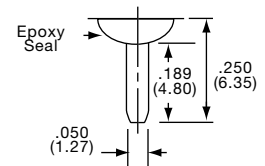

Single pole

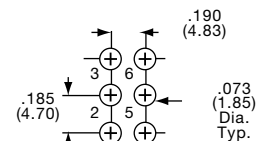

Double pole

Toggle Switches, A Series, Options

TERMINALS

A

Right Angle
Single Pole

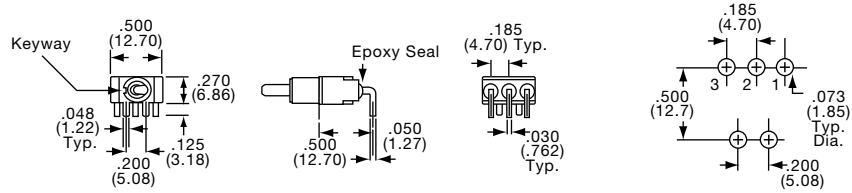

Note: Terminal numbers viewed from top of P.C. boards.

A

Right Angle
Double Pole

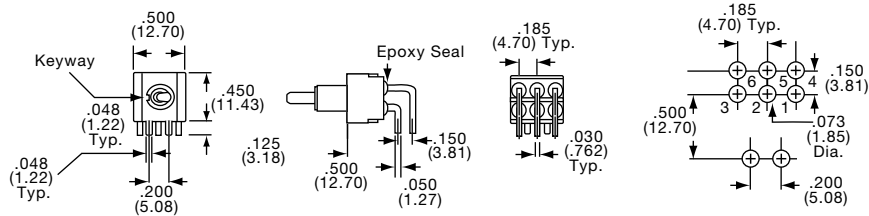

Note: Terminal numbers viewed from top of P.C. boards.

AV2

Vertical Right Angle
Single Pole

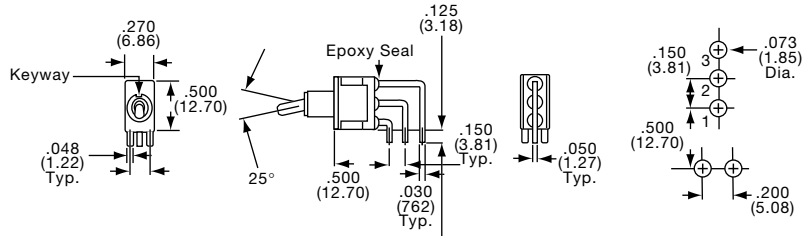

Note: Terminal numbers viewed from top of P.C. boards.

AV2

Vertical Right Angle
Double Pole

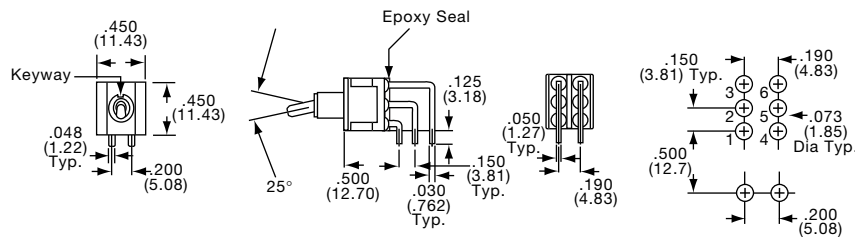

Note: Terminal numbers viewed from top of P.C. boards.

Toggle Switches, A Series, Options

TERMINALS NOTE: Terminal numbers viewed from top of P.C. board

V30 V40 V90

Vertical Support Bracket
Single Pole

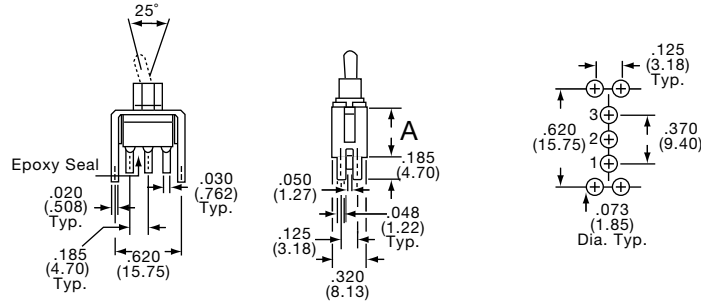

| Option Code | Dim."A" |
|-------------|---------------|
| V30 | .460 (11.68) |
| V40 | .630 (16.00) |
| V90 | 1.150 (29.21) |

Vertical Support Bracket
Double Pole

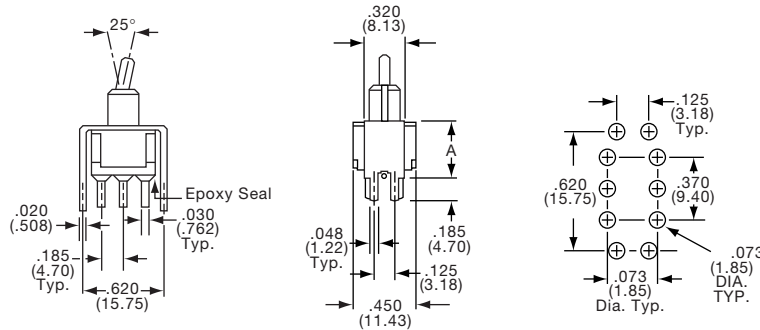

| Option Code | Dim."A" |
|-------------|---------------|
| V30 | .460 (11.68) |
| V40 | .630 (16.00) |
| V90 | 1.150 (29.21) |

CONTACTS

B CONTACTS: Copper alloy with gold plate, welded button.

TERMINALS: Brass with gold plate.

ELECTRICAL RATING: 0.4 VA @ 20 VAC/DC.

Q CONTACTS: Copper alloy with silver, welded button.

TERMINALS: Brass with tin/lead plate.

ELECTRICAL RATING: 5 A @ 125 VAC, 2 A @ 250 VAC, 2 A @ 30 VDC.

UL/CSA RATING: 5A @ 125 VAC, 3A @ 250 VAC. (Specify "UL" option code)

G CONTACTS: Copper alloy with gold plate over silver, welded button.

TERMINALS: Brass alloy, with gold plate.

Note: This contact option can be used for low-level or power switching. If level is above 0.4 VA @ 20 VAC/DC, the switch is rendered usable only for power switching due to arc-removal of gold plate.

UL/CSA RATING: 5A @ 125 VAC, 3A @ 250 VAC (Specify "UL" option code)

ELECTRICAL RATING: 0.4 VA @ 20 VAC/DC or 5 A @ 125 VAC, 2 A @ 250 VAC, 2 A @ 30 VDC.

Gemini Series

Toggle Switches, A Series, Vertical, Wire Lug, Long Bat Actuator

* Refer to Pages C22-C26 for Additional Options *

SEE PAGE C22 FOR PRODUCT SPECIFICATIONS

SPDT

| Tyco Electronics | Alcoswitch | Type | Act. Code | P.M5 | | | |
|------------------------|------------|------|-----------|------|------|------|------|
| Silver Contacts | | | | | | | |
| 5-1437554-0 | A101SYZQ | SPDT | 1 | | On | None | On |
| 7-1437554-7 | A103SYZQ | SPDT | 5 | | On | Off | On |
| 9-1437554-6 | A105SYZQ | SPDT | 5 | | (On) | Off | (On) |
| 1437555-9 | A107SYZQ | SPDT | 5 | | On | Off | (On) |
| 2-1437555-0 | A108SYZQ | SPDT | 1 | | On | None | (On) |
| Gold Contacts | | | | | | | |
| 4-1437554-9 | A101SYZB | SPDT | 1 | | On | None | On |
| 7-1437554-6 | A103SYZB | SPDT | 5 | | On | Off | On |
| 9-1437554-5 | A105SYZB | SPDT | 5 | | (On) | Off | (On) |
| | A107SYZB | SPDT | 5 | | On | Off | (On) |

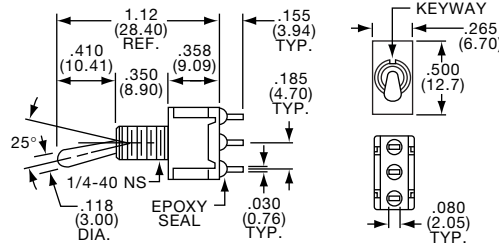

A101SYZQ

G
Gemini Series

DPDT

| Tyco Electronics | Alcoswitch | Type | Act. Code | P.M5 | | | |
|------------------------|------------|------|-----------|------|------|------|------|
| Silver Contacts | | | | | | | |
| 4-1437555-9 | A201SYZQ | DPDT | 2 | | On | None | On |
| 6-1437555-2 | A203SYZQ | DPDT | 6 | | On | Off | On |
| 7-1437555-0 | A205SYZQ | DPDT | 6 | | (On) | Off | (On) |
| 7-1437555-6 | A207SYZQ | DPDT | 6 | | On | Off | (On) |
| 8-1437555-5 | A208SYZQ | DPDT | 2 | | On | None | (On) |
| 1437556-1 | A211SYZQ | SP3T | 11 | | On | On | On |
| 1437556-4 | A213SYZQ | SP3T | 11 | | On | On | (On) |
| 1437556-7 | A215SYZQ | SP3T | 11 | | (On) | On | (On) |

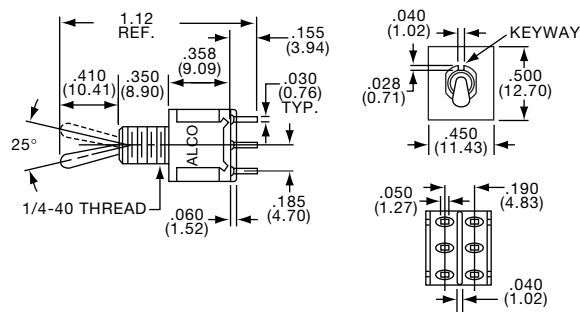

A201SYZQ

Toggle Switches, A Series, PC Terminals, Long Bat Actuators

* Refer to Pages C22-C26 for Additional Options *

SEE PAGE C22 FOR PRODUCT SPECIFICATIONS

SPDT/DPDT



A101SYAB
Horizontal Actuation

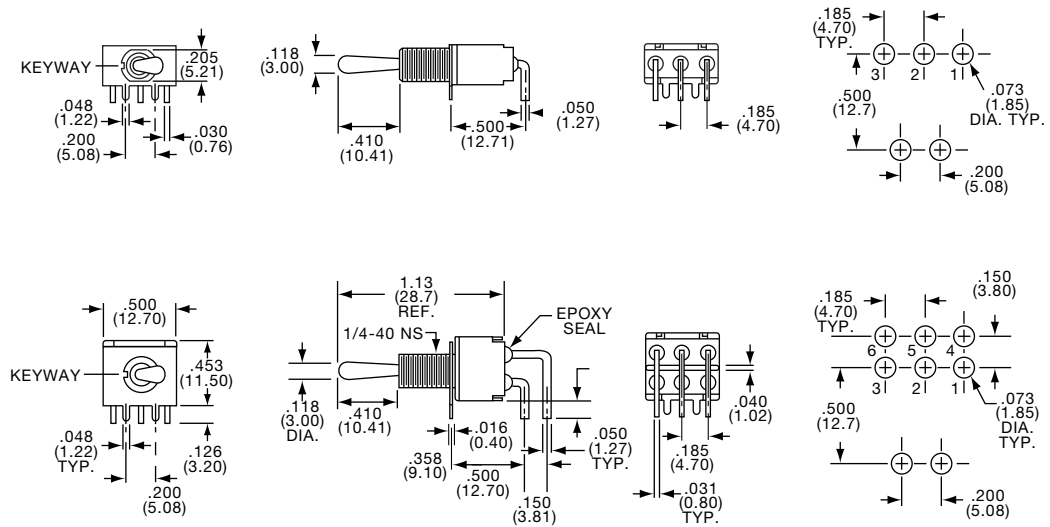

| Tyco Electronics | Alcoswitch | Type | Act. Code | P.M5 | ↘ | ↓ | ↙ |
|----------------------|------------|------|-----------|------|----|------|------|
| Gold Contacts | | | | | | | |
| 4-1437554-3 | A101SYAB | SPDT | 1 | | On | None | On |
| | A103SYAB | SPDT | 5 | | On | Off | On |
| 4-1437555-3 | A201SYAB | DPDT | 2 | | On | None | On |
| | A208SYAB | DPDT | 2 | | On | None | (On) |

SPDT/DPDT



A101SYCB



A201SYCB

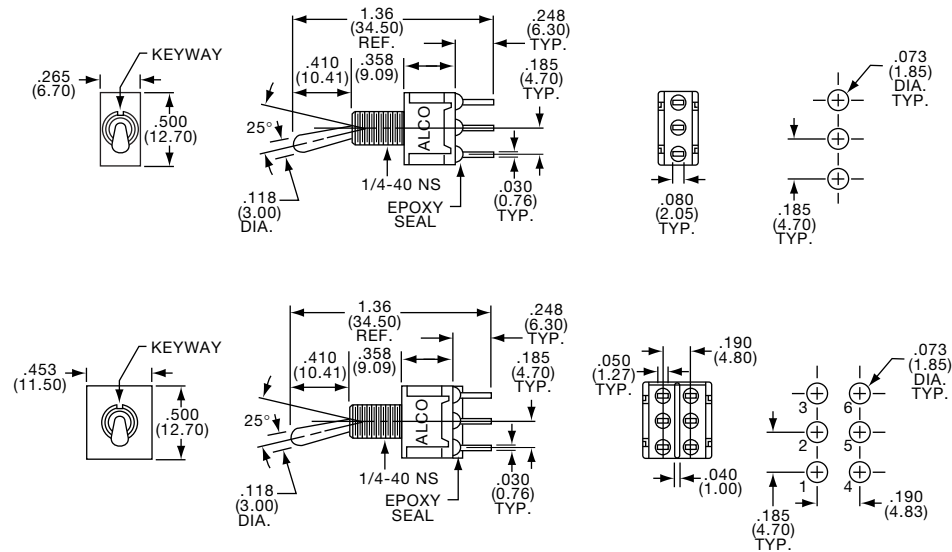

| Tyco Electronics | Alcoswitch | Type | Act. Code | P.M5 | ↘ | ↓ | ↙ |
|----------------------|------------|------|-----------|------|----|------|------|
| Gold Contacts | | | | | | | |
| 4-1437554-5 | A101SYCB | SPDT | 1 | | On | None | On |
| 7-1437554-2 | A103SYCB | SPDT | 5 | | On | Off | On |
| 1-1437555-8 | A108SYCB | SPDT | 1 | | On | None | (On) |
| 4-1437555-5 | A201SYCB | DPDT | 2 | | On | None | On |
| 6-1437555-0 | A203SYCB | DPDT | 6 | | On | Off | On |
| 8-1437555-3 | A208SYCB | DPDT | 2 | | On | None | (On) |

Toggle Switches, A Series, Wire Wrap or Wire Lug, Long Bat Actuators

* Refer to Pages C22-C26 for Additional Options *

SEE PAGE C22 FOR PRODUCT SPECIFICATIONS

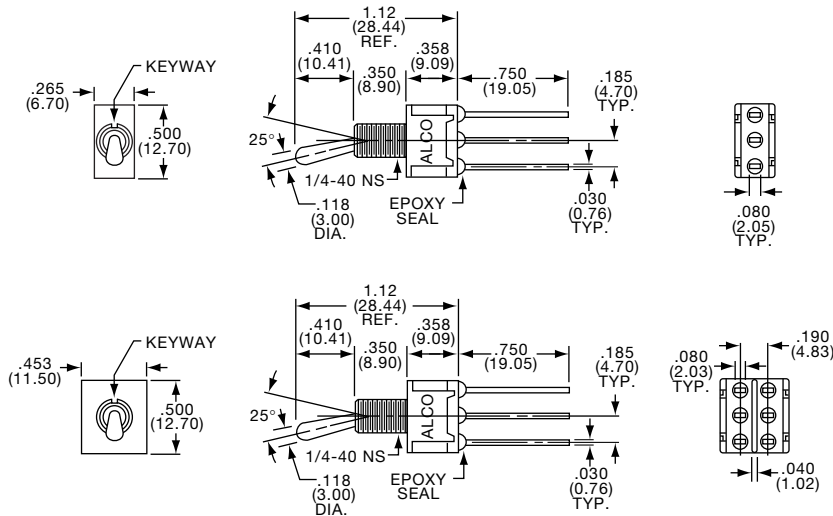

SPDT/DPDT



G
Gemini Series

| Tyco Electronics | Alcoswitch | Type | Act. Code | P.M5 | | | |
|------------------------|------------|------|-----------|------------|--|--|--|
| Silver Contacts | | | | | | | |
| 4-1437554-8 | A101SYWQ | SPDT | 1 | On None On | | | |
| 7-1437554-5 | A103SYWQ | SPDT | 5 | On Off On | | | |
| 4-1437555-7 | A201SYWQ | DPDT | 2 | On None On | | | |
| | A203SYWQ | DPDT | 6 | On Off On | | | |

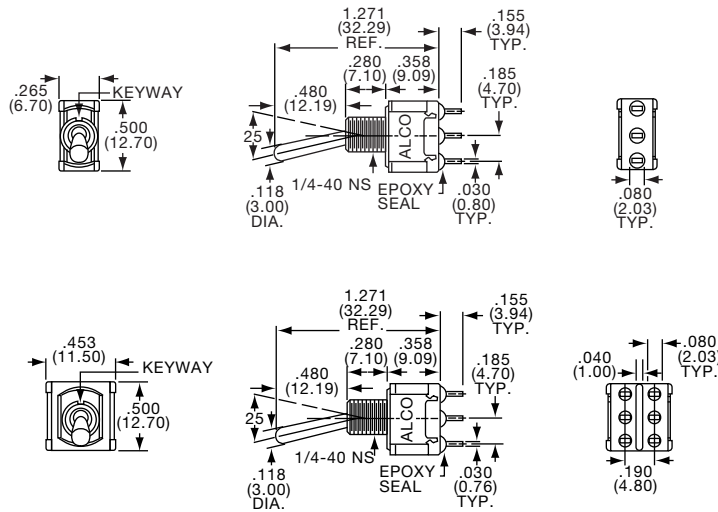

SPDT/DPDT



| Tyco Electronics | Alcoswitch | Type | Act. Code | P.M5 | | | |
|------------------------|------------|------|-----------|------------|--|--|--|
| Silver Contacts | | | | | | | |
| 4-1437554-0 | A101SDZQ | SPDT | 1 | On None On | | | |
| 6-1437554-9 | A103SDZQ | SPDT | 5 | On Off On | | | |
| 4-1437555-1 | A201SDZQ | DPDT | 2 | On None On | | | |
| 5-1437555-9 | A203SDZQ | DPDT | 6 | On Off On | | | |

Toggle Switches, A Series, PC Tail, Straight or Right Angle, Long Bat Actuator

* Refer to Pages C22-C26 for Additional Options *

SEE PAGE C22 FOR PRODUCT SPECIFICATIONS

SPDT



A101SDCQ

DPDT



A201SDCQ

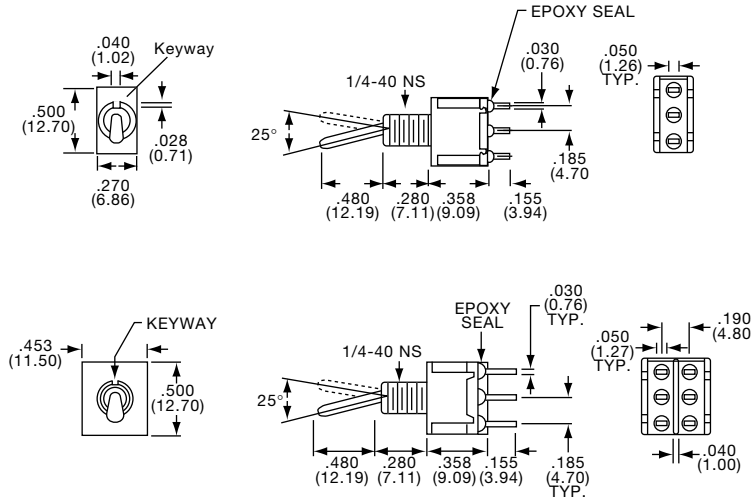

| Tyco Electronics | Alcoswitch | Type | Act. Code | P.M5 | ↖ | ↓ | ↗ |
|------------------------|------------|------|-----------|------|----|------|------|
| Silver Contacts | | | | | | | |
| 3-1437554-9 | A101SDCQ | SPDT | 1 | | On | None | On |
| 6-1437554-8 | A103SDCQ | SPDT | 5 | | On | Off | On |
| 1571670-1 | A201SDCQ | DPDT | 2 | | On | None | On |
| | A203SDCQ | DPDT | 6 | | On | Off | On |
| | A208SDCQ | DPDT | 2 | | On | None | (On) |

SPDT/DPDT



A101SD9AQ

Horizontal Actuation

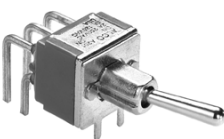
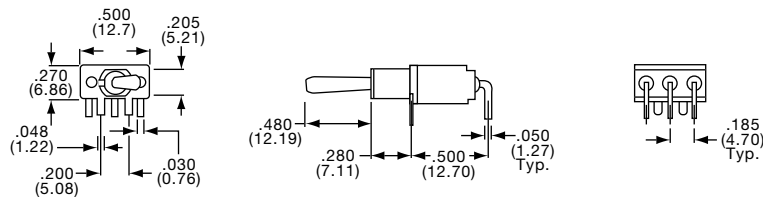

A201SD9AQ

Horizontal Actuation

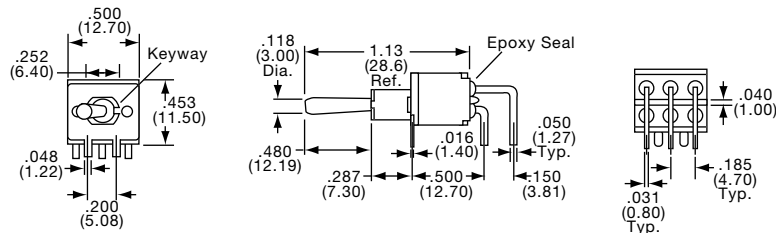

| Tyco Electronics | Alcoswitch | Tyco Electronics | Alcoswitch | Type | Act. Code | P. M5 | ↖ | ↓ | ↗ |
|------------------------|------------|------------------|------------|----------------------|-----------|-------|----|------|------|
| Silver Contacts | | | | Gold Contacts | | | | | |
| 3-1437554-4 | A101SD9AQ | 3-1437554-3 | A101SD9AB | SPDT | 1 | | On | None | On |
| 6-1437554-4 | A103SD9AQ | | A103SD9AB | SPDT | 5 | | On | Off | On |
| 1-1437555-6 | A108SD9AQ | | | SPDT | 1 | | On | None | (On) |
| 3-1437555-8 | A201SD9AQ | | A201SD9AB | DPDT | 2 | | On | None | On |
| 8-1437555-1 | A208SD9AQ | | A208SD9AB | DPDT | 2 | | On | None | (On) |

Toggle Switches, A Series, Vertical, Right Angle, Long Bat Actuator

* Refer to Pages C22-C26 for Additional Options *

SEE PAGE C22 FOR PRODUCT SPECIFICATIONS

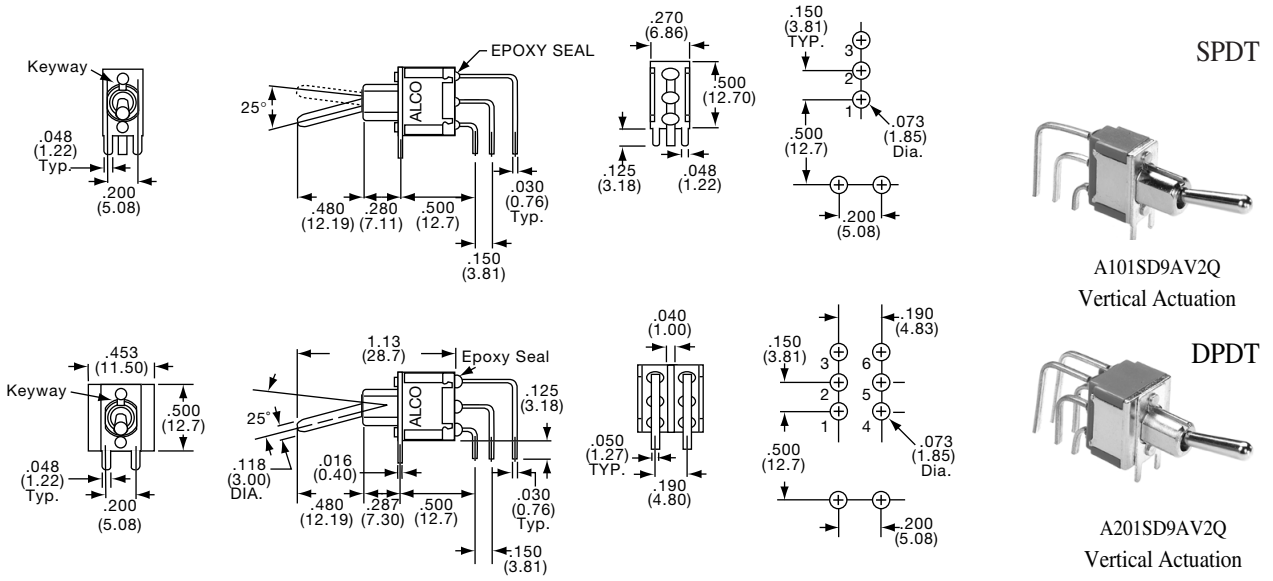

| Tyco Electronics | Alcoswitch | Type | Act. Code | P.M5 | On | None | On | Tyco Electronics | Alcoswitch | Type | Act. Code | P.M5 | On | None | On |
|------------------------|-------------|------|-----------|------|----|------|----|------------------|-------------|------|-----------|------|----|------|------|
| Silver Contacts | | | | | | | | | | | | | | | |
| 3-1437554-6 | A101SD9AV2Q | SPDT | 1 | | On | None | On | 3-1437555-9 | A201SD9AV2Q | DPDT | 2 | | On | None | On |
| 6-1437554-6 | A103SD9AV2Q | SPDT | 5 | | On | Off | On | 5-1437555-8 | A203SD9AV2Q | DPDT | 6 | | On | Off | On |
| | | | | | | | | 8-1437555-2 | A208SD9AV2Q | DPDT | 2 | | On | None | (On) |

Toggle Switches, A Series, Wire Lug, Locking Toggle

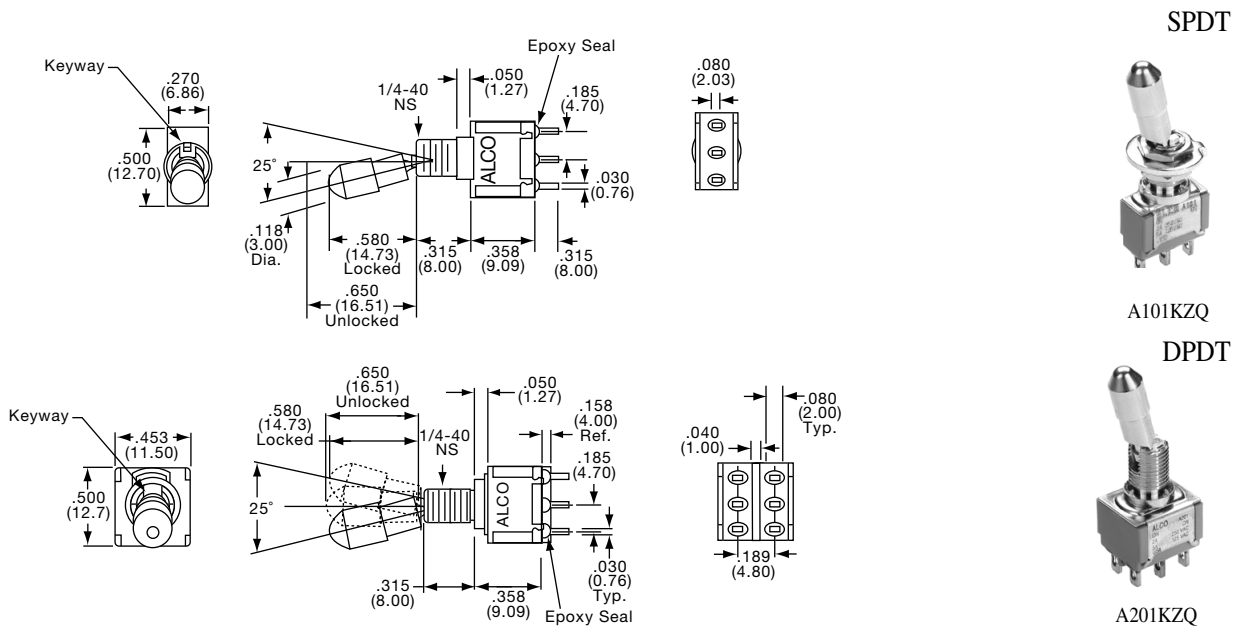

| Tyco Electronics | Alcoswitch | Type | Act. Code | P.M5 | On | None | On | Tyco Electronics | Alcoswitch | Tyco Electronics | Alcoswitch | Type | Act. Code | P.M5 | On | None | On | |
|------------------------|------------|------|-----------|------|----|------|----|----------------------|------------|------------------------|------------|-------------|-----------|------|------|------|------|----|
| Silver Contacts | | | | | | | | | | | | | | | | | | |
| 1437554-9 | A101KZQ | SPDT | 1 | | On | None | On | Gold Contacts | | Silver Contacts | | 2-1437555-5 | A201KZQ | DPDT | 2 | On | None | On |
| 5-1437554-8 | A103KZQ | SPDT | 5 | | On | Off | On | A203KZB | A203KZB | 5-1437555-3 | A203KZQ | DPDT | 6 | | On | Off | On | |
| | | | | | | | | 6-1437555-5 | A205KZB | | A205KZQ | DPDT | 6 | | (On) | Off | (On) | |
| | | | | | | | | 8-1437555-8 | A211KZB | | A211KZQ | SP3T | 11 | | On | On | On | |

* Refer to Pages C22-C26 for Additional Options *

Toggle Switches, A Series, Right Angle, Short Bat Actuators

SEE PAGE C22 FOR PRODUCT SPECIFICATIONS

SPDT



A101MD9AQ
Horizontal Actuation

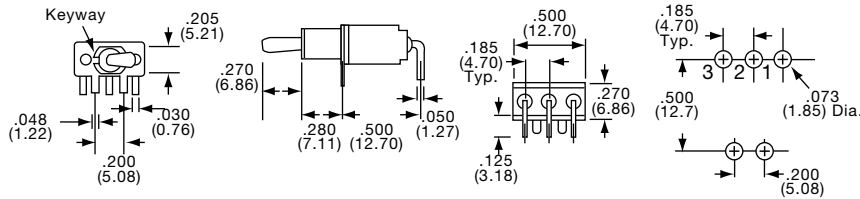

| Tyco Electronics | Alcoswitch | Tyco Electronics | Alcoswitch | Type | Act. Code | P. M5 | | | |
|------------------------|------------|----------------------|------------|------|-----------|-------|----|------|------|
| Silver Contacts | | Gold Contacts | | | | | | | |
| 1-1437554-6 | A101MD9AQ | 1-1437554-4 | A101MD9AB | SPDT | 1 | | On | None | On |
| 6-1437554-1 | A103MD9AQ | 5-1437554-9 | A103MD9AB | SPDT | 5 | | On | Off | On |
| | A108MD9AQ | 1-1437555-2 | A108MD9AB | SPDT | 1 | | On | None | (On) |

DPDT



A201MD9AQ
Horizontal Actuation

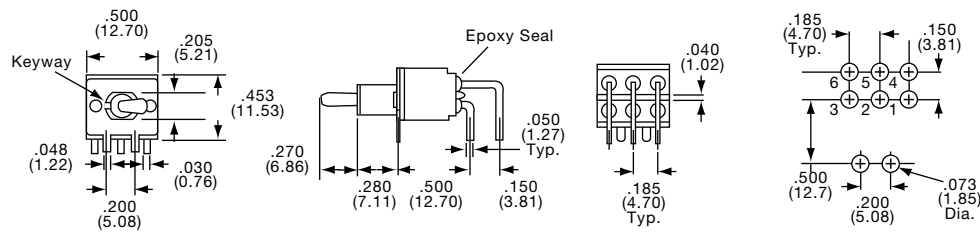

| Tyco Electronics | Alcoswitch | Tyco Electronics | Alcoswitch | Type | Act. Code | P. M5 | | | |
|------------------------|------------|----------------------|------------|------|-----------|-------|----|------|----|
| Silver Contacts | | Gold Contacts | | | | | | | |
| 2-1437555-8 | A201MD9AQ | 2-1437555-7 | A201MD9AB | DPDT | 2 | | On | None | On |
| | | 5-1437555-4 | A203MD9AB | DPDT | 6 | | On | Off | On |

SPDT



A101MD9AV2Q
Vertical Actuation

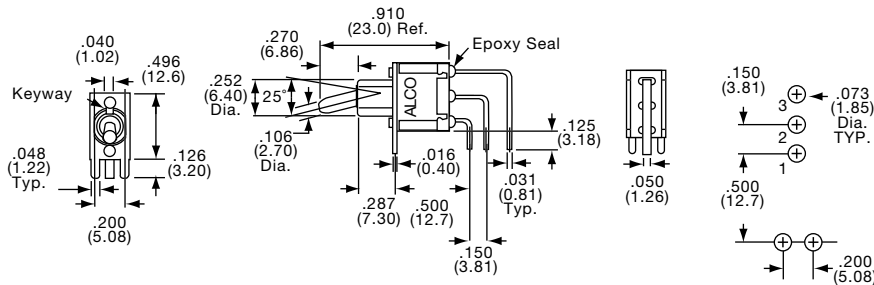

| Tyco Electronics | Alcoswitch | Tyco Electronics | Alcoswitch | Type | Act. Code | P. M5 | | | |
|------------------------|-------------|----------------------|-------------|------|-----------|-------|----|------|------|
| Silver Contacts | | Gold Contacts | | | | | | | |
| 1-1437554-9 | A101MD9AV2Q | 1-1437554-7 | A101MD9AV2B | SPDT | 1 | | On | None | On |
| | A103MD9AV2Q | 6-1437554-2 | A103MD9AV2B | SPDT | 5 | | On | Off | On |
| | A108MD9AV2Q | | | SPDT | 1 | | On | None | (On) |

DPDT

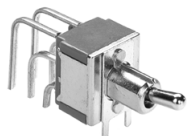

A201MD9AV2AQ
Vertical Actuation

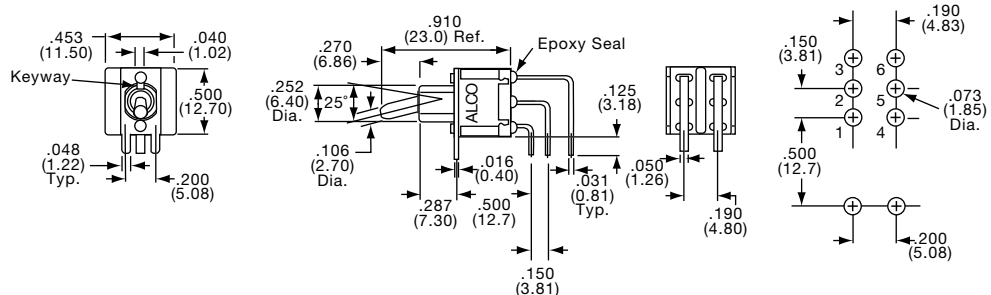

| Tyco Electronics | Alcoswitch | Tyco Electronics | Alcoswitch | Type | Act. Code | P. M5 | | | |
|------------------------|-------------|----------------------|-------------|------|-----------|-------|----|------|------|
| Silver Contacts | | Gold Contacts | | | | | | | |
| 3-1437555-0 | A201MD9AV2Q | 2-1437555-9 | A201MD9AV2B | DPDT | 2 | | On | None | On |
| | A203MD9AV2Q | | A203MD9AV2B | DPDT | 6 | | On | Off | On |
| | A208MD9AV2Q | | A208MD9AV2B | DPDT | 2 | | On | None | (On) |

Toggle Switches, A Series, Vertical, Wire Lug, Flat or Long Bat Actuator

* Refer to Pages C22-C26 for Additional Options *

SEE PAGE C22 FOR PRODUCT SPECIFICATIONS

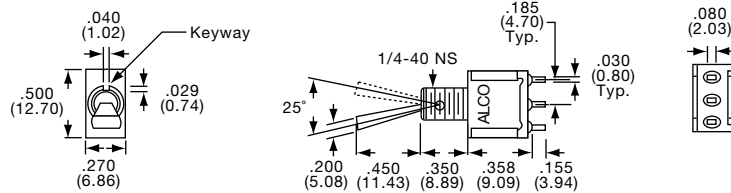

SPDT



A101P3YZQ

| Tyco Electronics | Alcoswitch | Type | Act. Code | P.M5 | | | |
|------------------------|------------|------|-----------|------|------|------|------|
| Silver Contacts | | | | | | | |
| 2-1437554-9 | A101P3YZQ | SPDT | 1 | | On | None | On |
| 6-1437554-3 | A103P3YZQ | SPDT | 5 | | On | Off | On |
| 8-1437554-7 | A105P3YZQ | SPDT | 5 | | (On) | Off | (On) |
| 1437555-5 | A107P3YZQ | SPDT | 5 | | On | Off | (On) |
| 1-1437555-5 | A108P3YZQ | SPDT | 1 | | On | None | (On) |

| Tyco Electronics | Alcoswitch | Type | Act. Code | P.M5 | | | |
|------------------------|------------|------|-----------|------|------|------|------|
| Silver Contacts | | | | | | | |
| 3-1437555-6 | A201P3YZQ | DPDT | 2 | | On | None | On |
| 5-1437555-6 | A203P3YZQ | DPDT | 6 | | On | Off | On |
| 6-1437555-6 | A205P3YZQ | DPDT | 6 | | (On) | Off | (On) |
| 7-1437555-3 | A207P3YZQ | DPDT | 6 | | On | Off | (On) |
| 8-1437555-0 | A208P3YZQ | DPDT | 2 | | On | None | (On) |
| 9-1436555-3 | A211P3YZQ | SP3T | 11 | | On | On | On |
| | A215P3YZQ | SP3T | 11 | | (On) | On | (On) |

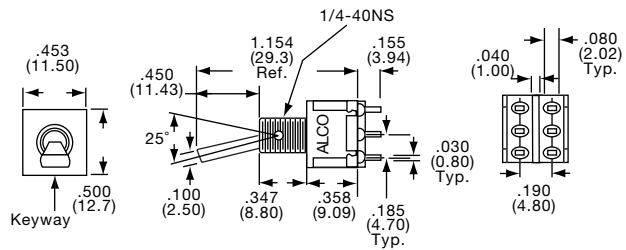

DPDT



A201P3YZQ

| Tyco Electronics | Alcoswitch | Type | Act. Code | P.M5 | | | |
|------------------------|------------|------|-----------|------|----|------|----|
| Silver Contacts | | | | | | | |
| 5-1437554-6 | A101TZQ | SPDT | 1 | | On | None | On |
| 8-1437554-0 | A103TZQ | SPDT | 5 | | On | Off | On |

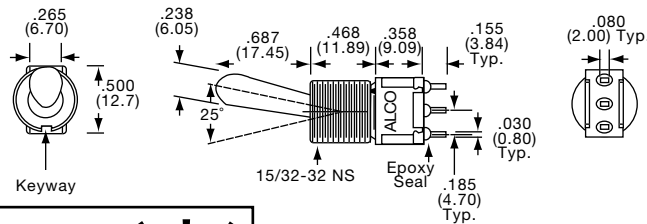

SPDT



A101TZQ

| Tyco Electronics | Alcoswitch | Type | Act. Code | P.M5 | | | |
|------------------------|------------|------|-----------|------|----|------|----|
| Silver Contacts | | | | | | | |
| 5-1437555-2 | A201TZQ | DPDT | 2 | | On | None | On |
| 6-1437555-4 | A203TZQ | DPDT | 6 | | On | Off | On |
| | A211TZQ | SP3T | 11 | | On | On | On |

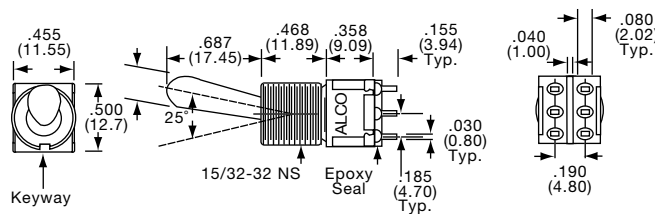

DPDT



A201TZQ

Toggle Switches, A Series, Wire Lug, 15/32 Bushing, Short Bat Actuator

* Refer to Pages C22-C26 for Additional Options *

SEE PAGE C22 FOR PRODUCT SPECIFICATIONS

SPDT



A103T1ZQ

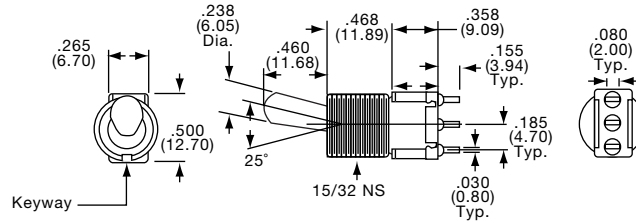

| Tyco Electronics | Alcoswitch | Type | Act. Code | P.M5 | ↘ | ↓ | ↙ |
|------------------------|------------|------|-----------|------|------|------|------|
| Silver Contacts | | | | | | | |
| 5-1437554-4 | A101T1ZQ | SPDT | 1 | | On | None | On |
| 7-1437554-9 | A103T1ZQ | SPDT | 5 | | On | Off | On |
| 9-1437554-8 | A105T1ZQ | SPDT | 5 | | (On) | Off | (On) |
| | A108T1ZQ | SPDT | 1 | | On | None | (On) |

DPDT



A201T1ZQ

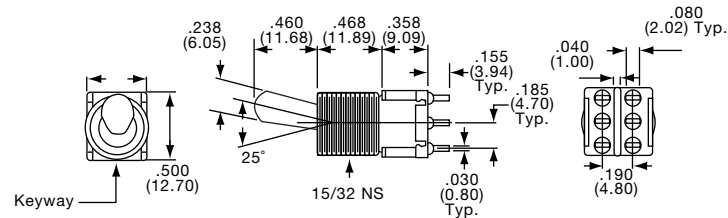

| Tyco Electronics | Alcoswitch | Type | Act. Code | P.M5 | ↘ | ↓ | ↙ |
|------------------------|------------|------|-----------|------|------|------|------|
| Silver Contacts | | | | | | | |
| 5-1437555-0 | A201T1ZQ | DPDT | 2 | | On | None | On |
| 6-1437555-3 | A203T1ZQ | DPDT | 6 | | On | Off | On |
| 7-1437555-1 | A205T1ZQ | DPDT | 6 | | (On) | Off | (On) |
| 7-1437555-7 | A207T1ZQ | DPDT | 6 | | On | Off | (On) |
| 8-1437555-6 | A208T1ZQ | DPDT | 2 | | On | None | (On) |
| 1437556-2 | A211T1ZQ | SP3T | 11 | | On | On | On |



Компания «ЭлектроПласт» предлагает заключение долгосрочных отношений при поставках импортных электронных компонентов на взаимовыгодных условиях!

Наши преимущества:

- Оперативные поставки широкого спектра электронных компонентов отечественного и импортного производства напрямую от производителей и с крупнейших мировых складов;
- Поставка более 17-ти миллионов наименований электронных компонентов;
- Поставка сложных, дефицитных, либо снятых с производства позиций;
- Оперативные сроки поставки под заказ (от 5 рабочих дней);
- Экспресс доставка в любую точку России;
- Техническая поддержка проекта, помощь в подборе аналогов, поставка прототипов;
- Система менеджмента качества сертифицирована по Международному стандарту ISO 9001;
- Лицензия ФСБ на осуществление работ с использованием сведений, составляющих государственную тайну;
- Поставка специализированных компонентов (Xilinx, Altera, Analog Devices, Intersil, Interpoint, Microsemi, Aeroflex, Peregrine, Syfer, Eurofarad, Texas Instrument, Miteq, Cobham, E2V, MA-COM, Hittite, Mini-Circuits, General Dynamics и др.);

Помимо этого, одним из направлений компании «ЭлектроПласт» является направление «Источники питания». Мы предлагаем Вам помощь Конструкторского отдела:

- Подбор оптимального решения, техническое обоснование при выборе компонента;
- Подбор аналогов;
- Консультации по применению компонента;
- Поставка образцов и прототипов;
- Техническая поддержка проекта;
- Защита от снятия компонента с производства.



Как с нами связаться

Телефон: 8 (812) 309 58 32 (многоканальный)

Факс: 8 (812) 320-02-42

Электронная почта: org@eplast1.ru

Адрес: 198099, г. Санкт-Петербург, ул. Калинина, дом 2, корпус 4, литера А.