

## Single-Ended, Rail-to-Rail I/O, Low Gain PGA

### Features

- Multiplexed Inputs: 1, 2, 6 or 8 channels
- 8 Gain Selections:
  - +1, +2, +4, +5, +8, +10, +16 or +32 V/V
- Serial Peripheral Interface (SPI)
- Rail-to-Rail Input and Output
- Low Gain Error:  $\pm 1\%$  (max)
- Low Offset:  $\pm 275 \mu\text{V}$  (max)
- High Bandwidth: 2 to 12 MHz (typ)
- Low Noise: 10 nV/ $\sqrt{\text{Hz}}$  @ 10 kHz (typ)
- Low Supply Current: 1.0 mA (typ)
- Single Supply: 2.5V to 5.5V

### Typical Applications

- A/D Converter Driver
- Multiplexed Analog Applications
- Data Acquisition
- Industrial Instrumentation
- Test Equipment
- Medical Instrumentation

### Package Types



### Description

The Microchip Technology Inc. MCP6S21/2/6/8 are analog Programmable Gain Amplifiers (PGA). They can be configured for gains from +1 V/V to +32 V/V and the input multiplexer can select one of up to eight channels through an SPI port. The serial interface can also put the PGA into shutdown to conserve power. These PGAs are optimized for high speed, low offset voltage and single-supply operation with rail-to-rail input and output capability. These specifications support single supply applications needing flexible performance or multiple inputs.

The one channel MCP6S21 and the two channel MCP6S22 are available in 8-pin PDIP, SOIC and MSOP packages. The six channel MCP6S26 is available in 14-pin PDIP, SOIC and TSSOP packages. The eight channel MCP6S28 is available in 16-pin PDIP and SOIC packages. All parts are fully specified from -40°C to +85°C.

### Block Diagram



# MCP6S21/2/6/8

## 1.0 ELECTRICAL CHARACTERISTICS

### Absolute Maximum Ratings †

$V_{DD} - V_{SS}$ .....	7.0V
All inputs and outputs .....	$V_{SS} - 0.3V$ to $V_{DD} + 0.3V$
Difference Input voltage .....	$ V_{DD} - V_{SS} $
Output Short Circuit Current.....	continuous
Current at Input Pin .....	$\pm 2$ mA
Current at Output and Supply Pins .....	$\pm 30$ mA
Storage temperature .....	$-65^{\circ}\text{C}$ to $+150^{\circ}\text{C}$
Junction temperature .....	$+150^{\circ}\text{C}$
ESD protection on all pins (HBM;MM).....	$\geq 2$ kV; 200V

† **Notice:** Stresses above those listed under "Maximum Ratings" may cause permanent damage to the device. This is a stress rating only and functional operation of the device at those or any other conditions above those indicated in the operation listings of this specification is not implied. Exposure to maximum rating conditions for extended periods may affect device reliability.

### DC CHARACTERISTICS

<b>Electrical Specifications:</b> Unless otherwise indicated, $T_A = +25^{\circ}\text{C}$ , $V_{DD} = +2.5V$ to $+5.5V$ , $V_{SS} = \text{GND}$ , $V_{REF} = V_{SS}$ , $G = +1$ V/V, Input = CH0 = (0.3V)/G, CH1 to CH7 = 0.3V, $R_L = 10$ k $\Omega$ to $V_{DD}/2$ , SI and SCK are tied low and $\overline{\text{CS}}$ is tied high.							
Parameters	Sym	Min	Typ	Max	Units	Conditions	
<b>Amplifier Input</b>							
Input Offset Voltage	$V_{OS}$	-275	—	+275	$\mu\text{V}$	$G = +1$ , $V_{DD} = 4.0V$	
Input Offset Voltage Drift	$\Delta V_{OS}/\Delta T_A$	—	$\pm 4$	—	$\mu\text{V}/^{\circ}\text{C}$	$T_A = -40$ to $+85^{\circ}\text{C}$	
Power Supply Rejection Ratio	PSRR	70	85	—	dB	$G = +1$ ( <b>Note 1</b> )	
Input Bias Current	$I_B$	—	$\pm 1$	—	pA	$\text{CHx} = V_{DD}/2$	
Input Bias Current over Temperature	$I_B$	—	—	250	pA	$T_A = -40$ to $+85^{\circ}\text{C}$ , $\text{CHx} = V_{DD}/2$	
Input Impedance	$Z_{IN}$	—	$10^{13}  15$	—	$\Omega  \text{pF}$		
Input Voltage Range	$V_{IVR}$	$V_{SS}-0.3$	—	$V_{DD}+0.3$	V		
<b>Amplifier Gain</b>							
Nominal Gains	—	—	1 to 32	—	V/V	+1, +2, +4, +5, +8, +10, +16 or +32	
DC Gain Error	$G = +1$	$g_E$	-0.1	—	+0.1	%	$V_{OUT} \approx 0.3V$ to $V_{DD} - 0.3V$
	$G \geq +2$	$g_E$	-1.0	—	+1.0	%	$V_{OUT} \approx 0.3V$ to $V_{DD} - 0.3V$
DC Gain Drift	$G = +1$	$\Delta G/\Delta T_A$	—	$\pm 0.0002$	—	$\%/^{\circ}\text{C}$	$T_A = -40$ to $+85^{\circ}\text{C}$
	$G \geq +2$	$\Delta G/\Delta T_A$	—	$\pm 0.0004$	—	$\%/^{\circ}\text{C}$	$T_A = -40$ to $+85^{\circ}\text{C}$
Internal Resistance	$R_{LAD}$	3.4	4.9	6.4	k $\Omega$	( <b>Note 1</b> )	
Internal Resistance over Temperature	$\Delta R_{LAD}/\Delta T_A$	—	+0.028	—	$\%/^{\circ}\text{C}$	( <b>Note 1</b> ) $T_A = -40$ to $+85^{\circ}\text{C}$	
<b>Amplifier Output</b>							
DC Output Non-linearity	$G = +1$	$V_{ONL}$	—	$\pm 0.003$	—	% of FSR	$V_{OUT} = 0.3V$ to $V_{DD} - 0.3V$ , $V_{DD} = 5.0V$
	$G \geq +2$	$V_{ONL}$	—	$\pm 0.001$	—	% of FSR	$V_{OUT} = 0.3V$ to $V_{DD} - 0.3V$ , $V_{DD} = 5.0V$
Maximum Output Voltage Swing	$V_{OH}$ , $V_{OL}$	$V_{SS}+20$	—	$V_{DD}-100$	mV		$G \geq +2$ ; 0.5V output overdrive
		$V_{SS}+60$	—	$V_{DD}-60$			$G \geq +2$ ; 0.5V output overdrive, $V_{REF} = V_{DD}/2$
Short-Circuit Current	$I_{O(SC)}$	—	$\pm 30$	—	mA		

**Note 1:**  $R_{LAD}$  ( $R_F + R_G$  in Figure 4-1) connects  $V_{REF}$ ,  $V_{OUT}$  and the inverting input of the internal amplifier. The MCP6S22 has  $V_{REF}$  tied internally to  $V_{SS}$ , so  $V_{SS}$  is coupled to the internal amplifier and the PSRR spec describes PSRR+ only. We recommend the MCP6S22's  $V_{SS}$  pin be tied directly to ground to avoid noise problems.

**2:**  $I_Q$  includes current in  $R_{LAD}$  (typically 60  $\mu\text{A}$  at  $V_{OUT} = 0.3V$ ). Both  $I_Q$  and  $I_{Q\_SHDN}$  exclude digital switching currents.

**3:** The output goes Hi-Z and the registers reset to their defaults; see Section 5.4, "Power-On Reset".

### PIN FUNCTION TABLE

Name	Function
$V_{OUT}$	Analog Output
CH0-CH7	Analog Inputs
$V_{SS}$	Negative Power Supply
$V_{DD}$	Positive Power Supply
SCK	SPI Clock Input
SI	SPI Serial Data Input
SO	SPI Serial Data Output
$\overline{\text{CS}}$	SPI Chip Select
$V_{REF}$	External Reference Pin

## DC CHARACTERISTICS (CONTINUED)

**Electrical Specifications:** Unless otherwise indicated,  $T_A = +25^\circ\text{C}$ ,  $V_{DD} = +2.5\text{V}$  to  $+5.5\text{V}$ ,  $V_{SS} = \text{GND}$ ,  $V_{REF} = V_{SS}$ ,  $G = +1\text{ V/V}$ , Input = CH0 =  $(0.3\text{V})/G$ , CH1 to CH7 =  $0.3\text{V}$ ,  $R_L = 10\text{ k}\Omega$  to  $V_{DD}/2$ , SI and SCK are tied low and CS is tied high.

Parameters	Sym	Min	Typ	Max	Units	Conditions
<b>Power Supply</b>						
Supply Voltage	$V_{DD}$	2.5	—	5.5	V	
Quiescent Current	$I_Q$	0.5	1.0	1.35	mA	$I_O = 0$ (Note 2)
Quiescent Current, Shutdown mode	$I_{Q\_SHDN}$	—	0.5	1.0	$\mu\text{A}$	$I_O = 0$ (Note 2)
<b>Power-On Reset</b>						
POR Trip Voltage	$V_{POR}$	1.2	1.7	2.2	V	(Note 3)
POR Trip Voltage Drift	$\Delta V_{POR}/\Delta T$	—	-3.0	—	$\text{mV}/^\circ\text{C}$	$T_A = -40^\circ\text{C}$ to $+85^\circ\text{C}$

- Note 1:**  $R_{LAD}$  ( $R_F + R_G$  in Figure 4-1) connects  $V_{REF}$ ,  $V_{OUT}$  and the inverting input of the internal amplifier. The MCP6S22 has  $V_{REF}$  tied internally to  $V_{SS}$ , so  $V_{SS}$  is coupled to the internal amplifier and the PSRR spec describes PSRR+ only. We recommend the MCP6S22's  $V_{SS}$  pin be tied directly to ground to avoid noise problems.
- Note 2:**  $I_Q$  includes current in  $R_{LAD}$  (typically  $60\text{ }\mu\text{A}$  at  $V_{OUT} = 0.3\text{V}$ ). Both  $I_Q$  and  $I_{Q\_SHDN}$  exclude digital switching currents.
- Note 3:** The output goes Hi-Z and the registers reset to their defaults; see Section 5.4, "Power-On Reset".

## AC CHARACTERISTICS

**Electrical Specifications:** Unless otherwise indicated,  $T_A = +25^\circ\text{C}$ ,  $V_{DD} = +2.5\text{V}$  to  $+5.5\text{V}$ ,  $V_{SS} = \text{GND}$ ,  $V_{REF} = V_{SS}$ ,  $G = +1\text{ V/V}$ , Input = CH0 =  $(0.3\text{V})/G$ , CH1 to CH7 =  $0.3\text{V}$ ,  $R_L = 10\text{ k}\Omega$  to  $V_{DD}/2$ ,  $C_L = 60\text{ pF}$ , SI and SCK are tied low, and CS is tied high.

Parameters	Sym	Min	Typ	Max	Units	Conditions
<b>Frequency Response</b>						
-3 dB Bandwidth	BW	—	2 to 12	—	MHz	All gains; $V_{OUT} < 100\text{ mV}_{P-P}$ (Note 1)
Gain Peaking	GPK	—	0	—	dB	All gains; $V_{OUT} < 100\text{ mV}_{P-P}$
<b>Total Harmonic Distortion plus Noise</b>						
$f = 1\text{ kHz}$ , $G = +1\text{ V/V}$	THD+N	—	0.0015	—	%	$V_{OUT} = 1.5\text{V} \pm 1.0\text{V}_{PK}$ , $V_{DD} = 5.0\text{V}$ , BW = 22 kHz
$f = 1\text{ kHz}$ , $G = +4\text{ V/V}$	THD+N	—	0.0058	—	%	$V_{OUT} = 1.5\text{V} \pm 1.0\text{V}_{PK}$ , $V_{DD} = 5.0\text{V}$ , BW = 22 kHz
$f = 1\text{ kHz}$ , $G = +16\text{ V/V}$	THD+N	—	0.023	—	%	$V_{OUT} = 1.5\text{V} \pm 1.0\text{V}_{PK}$ , $V_{DD} = 5.0\text{V}$ , BW = 22 kHz
$f = 20\text{ kHz}$ , $G = +1\text{ V/V}$	THD+N	—	0.0035	—	%	$V_{OUT} = 1.5\text{V} \pm 1.0\text{V}_{PK}$ , $V_{DD} = 5.0\text{V}$ , BW = 80 kHz
$f = 20\text{ kHz}$ , $G = +4\text{ V/V}$	THD+N	—	0.0093	—	%	$V_{OUT} = 1.5\text{V} \pm 1.0\text{V}_{PK}$ , $V_{DD} = 5.0\text{V}$ , BW = 80 kHz
$f = 20\text{ kHz}$ , $G = +16\text{ V/V}$	THD+N	—	0.036	—	%	$V_{OUT} = 1.5\text{V} \pm 1.0\text{V}_{PK}$ , $V_{DD} = 5.0\text{V}$ , BW = 80 kHz
<b>Step Response</b>						
Slew Rate	SR	—	4.0	—	$\text{V}/\mu\text{s}$	$G = 1, 2$
		—	11	—	$\text{V}/\mu\text{s}$	$G = 4, 5, 8, 10$
		—	22	—	$\text{V}/\mu\text{s}$	$G = 16, 32$
<b>Noise</b>						
Input Noise Voltage	$E_{ni}$	—	3.2	—	$\mu\text{V}_{P-P}$	$f = 0.1\text{ Hz}$ to $10\text{ kHz}$ (Note 2)
		—	26	—		$f = 0.1\text{ Hz}$ to $200\text{ kHz}$ (Note 2)
Input Noise Voltage Density	$e_{ni}$	—	10	—	$\text{nV}/\sqrt{\text{Hz}}$	$f = 10\text{ kHz}$ (Note 2)
Input Noise Current Density	$i_{ni}$	—	4	—	$\text{fA}/\sqrt{\text{Hz}}$	$f = 10\text{ kHz}$

- Note 1:** See Table 4-1 for a list of typical numbers.
- Note 2:**  $E_{ni}$  and  $e_{ni}$  include ladder resistance noise. See Figure 2-33 for  $e_{ni}$  vs.  $G$  data.

# MCP6S21/2/6/8

## DIGITAL CHARACTERISTICS

**Electrical Specifications:** Unless otherwise indicated,  $T_A = +25^\circ\text{C}$ ,  $V_{DD} = +2.5\text{V}$  to  $+5.5\text{V}$ ,  $V_{SS} = \text{GND}$ ,  $V_{REF} = V_{SS}$ ,  $G = +1\text{ V/V}$ , Input = CH0 = (0.3V)/G, CH1 to CH7 = 0.3V,  $R_L = 10\text{ k}\Omega$  to  $V_{DD}/2$ ,  $C_L = 60\text{ pF}$ , SI and SCK are tied low, and  $\overline{\text{CS}}$  is tied high.

Parameters	Sym	Min	Typ	Max	Units	Conditions
<b>SPI Inputs (<math>\overline{\text{CS}}</math>, SI, SCK)</b>						
Logic Threshold, Low	$V_{IL}$	0	—	$0.3V_{DD}$	V	
Input Leakage Current	$I_{IL}$	-1.0	—	+1.0	$\mu\text{A}$	
Logic Threshold, High	$V_{IH}$	$0.7V_{DD}$	—	$V_{DD}$	V	
Amplifier Output Leakage Current	—	-1.0	—	+1.0	$\mu\text{A}$	In Shutdown mode
<b>SPI Output (SO, for MCP6S26 and MCP6S28)</b>						
Logic Threshold, Low	$V_{OL}$	$V_{SS}$	—	$V_{SS}+0.4$	V	$I_{OL} = 2.1\text{ mA}$ , $V_{DD} = 5\text{V}$
Logic Threshold, High	$V_{OH}$	$V_{DD}-0.5$	—	$V_{DD}$	V	$I_{OH} = -400\text{ }\mu\text{A}$
<b>SPI Timing</b>						
Pin Capacitance	$C_{PIN}$	—	10	—	pF	All digital I/O pins
Input Rise/Fall Times ( $\overline{\text{CS}}$ , SI, SCK)	$t_{RFI}$	—	—	2	$\mu\text{s}$	<b>Note 1</b>
Output Rise/Fall Times (SO)	$t_{RFO}$	—	5	—	ns	MCP6S26 and MCP6S28
$\overline{\text{CS}}$ high time	$t_{CSH}$	40	—	—	ns	
SCK edge to $\overline{\text{CS}}$ fall setup time	$t_{CS0}$	10	—	—	ns	SCK edge when $\overline{\text{CS}}$ is high
$\overline{\text{CS}}$ fall to first SCK edge setup time	$t_{CSSC}$	40	—	—	ns	
SCK Frequency	$f_{SCK}$	—	—	10	MHz	$V_{DD} = 5\text{V}$ ( <b>Note 2</b> )
SCK high time	$t_{HI}$	40	—	—	ns	
SCK low time	$t_{LO}$	40	—	—	ns	
SCK last edge to $\overline{\text{CS}}$ rise setup time	$t_{SCCS}$	30	—	—	ns	
$\overline{\text{CS}}$ rise to SCK edge setup time	$t_{CS1}$	100	—	—	ns	SCK edge when $\overline{\text{CS}}$ is high
SI set-up time	$t_{SU}$	40	—	—	ns	
SI hold time	$t_{HD}$	10	—	—	ns	
SCK to SO valid propagation delay	$t_{DO}$	—	—	80	ns	MCP6S26 and MCP6S28
$\overline{\text{CS}}$ rise to SO forced to zero	$t_{SOZ}$	—	—	80	ns	MCP6S26 and MCP6S28
<b>Channel and Gain Select Timing</b>						
Channel Select Time	$t_{CH}$	—	1.5	—	$\mu\text{s}$	CHx = 0.6V, CHy = 0.3V, G = 1, CHx to CHy select $\overline{\text{CS}} = 0.7V_{DD}$ to $V_{OUT}$ 90% point
Gain Select Time	$t_G$	—	1	—	$\mu\text{s}$	CHx = 0.3V, G = 5 to G = 1 select, $\overline{\text{CS}} = 0.7V_{DD}$ to $V_{OUT}$ 90% point
<b>Shutdown Mode Timing</b>						
Out of Shutdown mode ( $\overline{\text{CS}}$ goes high) to Amplifier Output Turn-on Time	$t_{ON}$	—	3.5	10	$\mu\text{s}$	$\overline{\text{CS}} = 0.7V_{DD}$ to $V_{OUT}$ 90% point
Into Shutdown mode ( $\overline{\text{CS}}$ goes high) to Amplifier Output High-Z Turn-off Time	$t_{OFF}$	—	1.5	—	$\mu\text{s}$	$\overline{\text{CS}} = 0.7V_{DD}$ to $V_{OUT}$ 90% point
<b>POR Timing</b>						
Power-On Reset power-up time	$t_{RPU}$	—	30	—	$\mu\text{s}$	$V_{DD} = V_{POR} - 0.1\text{V}$ to $V_{POR} + 0.1\text{V}$ , 50% $V_{DD}$ to 90% $V_{OUT}$ point
Power-On Reset power-down time	$t_{RPD}$	—	10	—	$\mu\text{s}$	$V_{DD} = V_{POR} + 0.1\text{V}$ to $V_{POR} - 0.1\text{V}$ , 50% $V_{DD}$ to 90% $V_{OUT}$ point

**Note 1:** Not tested in production. Set by design and characterization.

**Note 2:** When using the device in the daisy chain configuration, maximum clock frequency is determined by a combination of propagation delay time ( $t_{DO} \leq 80\text{ ns}$ ), data input setup time ( $t_{SU} \geq 40\text{ ns}$ ), SCK high time ( $t_{HI} \geq 40\text{ ns}$ ), and SCK rise and fall times of 5 ns. Maximum  $f_{SCK}$  is, therefore,  $\approx 5.8\text{ MHz}$ .

## TEMPERATURE CHARACTERISTICS

**Electrical Specifications:** Unless otherwise indicated,  $V_{DD} = +2.5V$  to  $+5.5V$ ,  $V_{SS} = GND$ .

Parameters	Sym	Min	Typ	Max	Units	Conditions
<b>Temperature Ranges</b>						
Specified Temperature Range	$T_A$	-40	—	+85	°C	
Operating Temperature Range	$T_A$	-40	—	+125	°C	(Note 1)
Storage Temperature Range	$T_A$	-65	—	+150	°C	
<b>Thermal Package Resistances</b>						
Thermal Resistance, 8L-PDIP	$\theta_{JA}$	—	85	—	°C/W	
Thermal Resistance, 8L-SOIC	$\theta_{JA}$	—	163	—	°C/W	
Thermal Resistance, 8L-MSOP	$\theta_{JA}$	—	206	—	°C/W	
Thermal Resistance, 14L-PDIP	$\theta_{JA}$	—	70	—	°C/W	
Thermal Resistance, 14L-SOIC	$\theta_{JA}$	—	120	—	°C/W	
Thermal Resistance, 14L-TSSOP	$\theta_{JA}$	—	100	—	°C/W	
Thermal Resistance, 16L-PDIP	$\theta_{JA}$	—	70	—	°C/W	
Thermal Resistance, 16L-SOIC	$\theta_{JA}$	—	90	—	°C/W	

**Note 1:** The MCP6S21/2/6/8 family of PGAs operates over this extended temperature range, but with reduced performance. Operation in this range must not cause  $T_J$  to exceed the Maximum Junction Temperature (150°C).



**FIGURE 1-1:** Channel Select Timing Diagram.



**FIGURE 1-3:** Gain Select Timing Diagram.



**FIGURE 1-2:** PGA Shutdown timing diagram (must enter correct commands before CS goes high).



**FIGURE 1-4:** POR power-up and power-down timing diagram.

# MCP6S21/2/6/8



**FIGURE 1-5:** Detailed SPI Serial Interface Timing, SPI 0,0 mode.



**FIGURE 1-6:** Detailed SPI Serial Interface Timing, SPI 1,1 mode.

## 1.1 DC Output Voltage Specs / Model

### 1.1.1 IDEAL MODEL

The ideal PGA output voltage ( $V_{OUT}$ ) is:

#### EQUATION

$$V_{O\_ideal} = GV_{IN} \quad V_{REF} = V_{SS} = 0V$$

where: G is the nominal gain

(see Figure 1-7). This equation holds when there are no gain or offset errors and when the  $V_{REF}$  pin is tied to a low impedance source ( $\ll 0.1\Omega$ ) at ground potential ( $V_{SS} = 0V$ ).

### 1.1.2 LINEAR MODEL

The PGA's linear region of operation, including offset and gain errors, is modeled by the line  $V_{O\_linear}$ , shown in Figure 1-7.

#### EQUATION

$$V_{O\_linear} = G(1 + g_E)(V_{IN} - 0.3V + V_{OS}) + 0.3V$$

$$V_{REF} = V_{SS} = 0V$$

The endpoints of this line are at  $V_{O\_ideal} = 0.3V$  and  $V_{DD} - 0.3V$ . The gain and offset specifications are related to Figure 1-7, as follows:

#### EQUATION

$$g_E = 100\% \frac{V_2 - V_1}{G(V_{DD} - 0.6V)}$$

$$V_{OS} = \frac{V_1}{G(1 + g_E)} \quad G = +1$$

$$\Delta G / \Delta T_A = \frac{\Delta g_E}{\Delta T_A}$$



**FIGURE 1-7:** Output Voltage Model with the standard condition  $V_{REF} = V_{SS} = 0V$ .

### 1.1.3 OUTPUT NON-LINEARITY

Figure 1-8 shows the Integral Non-Linearity (INL) of the output voltage.

#### EQUATION

$$INL = V_{OUT} - V_{O\_linear}$$

The output non-linearity specification in the electrical specifications is related to Figure 1-8 by:

#### EQUATION

$$V_{ONL} = \frac{\max\{V_4, V_3\}}{V_{DD} - 0.6V}$$



**FIGURE 1-8:** Output Voltage INL with the standard condition  $V_{REF} = V_{SS} = 0V$ .

# MCP6S21/2/6/8

---

## 1.1.4 DIFFERENT $V_{REF}$ CONDITIONS

Some of the plots in Section 2.0, "Typical Performance Curves", have the conditions  $V_{REF} = V_{DD}/2$  or  $V_{REF} = V_{DD}$ . The equations and figures above are easily modified for these conditions. The ideal  $V_{OUT}$  becomes:

### EQUATION

$$V_{O\_ideal} = V_{REF} + G(V_{IN} - V_{REF})$$
$$V_{DD} \geq V_{REF} > V_{SS} = 0V$$

The complete linear model is:

### EQUATION

$$V_{O\_linear} = G(1 + g_E)(V_{IN} - V_{IN\_L} + V_{OS}) + 0.3V$$

where the new  $V_{IN}$  endpoints are:

### EQUATION

$$V_{IN\_L} = \frac{0.3V - V_{REF}}{G + V_{REF}}$$
$$V_{IN\_R} = \frac{V_{DD} - 0.3V - V_{REF}}{G + V_{REF}}$$

The equations for extracting the specifications do not change.



## 2.0 TYPICAL PERFORMANCE CURVES

**Note:** The graphs and tables provided following this note are a statistical summary based on a limited number of samples and are provided for informational purposes only. The performance characteristics listed herein are not tested or guaranteed. In some graphs or tables, the data presented may be outside the specified operating range (e.g., outside specified power supply range) and therefore outside the warranted range.

**Note:** Unless otherwise indicated,  $T_A = +25^\circ\text{C}$ ,  $V_{DD} = +5.0\text{V}$ ,  $V_{SS} = \text{GND}$ ,  $V_{REF} = V_{SS}$ ,  $G = +1 \text{ V/V}$ , Input = CH0 =  $(0.3\text{V})/G$ , CH1 to CH7 =  $0.3\text{V}$ ,  $R_L = 10 \text{ k}\Omega$  to  $V_{DD}/2$ , and  $C_L = 60 \text{ pF}$ .



**FIGURE 2-1:** DC Gain Error, G = +1.



**FIGURE 2-4:** DC Gain Drift, G = +1.



**FIGURE 2-2:** DC Gain Error, G ≥ +2.



**FIGURE 2-5:** DC Gain Drift, G ≥ +2.



**FIGURE 2-3:** Ladder Resistance Drift.



**FIGURE 2-6:** Input Offset Voltage,  $V_{DD} = 4.0\text{V}$ .

# MCP6S21/2/6/8

**Note:** Unless otherwise indicated,  $T_A = +25^\circ\text{C}$ ,  $V_{DD} = +5.0\text{V}$ ,  $V_{SS} = \text{GND}$ ,  $V_{REF} = V_{SS}$ ,  $G = +1 \text{ V/V}$ , Input = CH0 =  $(0.3\text{V})/G$ , CH1 to CH7 =  $0.3\text{V}$ ,  $R_L = 10 \text{ k}\Omega$  to  $V_{DD}/2$ , and  $C_L = 60 \text{ pF}$ .



**FIGURE 2-7:** Input Offset Voltage vs.  $V_{REF}$  Voltage.



**FIGURE 2-10:** Input Offset Voltage Drift.



**FIGURE 2-8:** DC Output Non-Linearity vs. Supply Voltage.



**FIGURE 2-11:** DC Output Non-Linearity vs. Output Swing.



**FIGURE 2-9:** Input Noise Voltage Density vs. Frequency.



**FIGURE 2-12:** Input Noise Voltage Density vs. Gain.

**Note:** Unless otherwise indicated,  $T_A = +25^\circ\text{C}$ ,  $V_{DD} = +5.0\text{V}$ ,  $V_{SS} = \text{GND}$ ,  $V_{REF} = V_{SS}$ ,  $G = +1 \text{ V/V}$ , Input = CH0 =  $(0.3\text{V})/G$ , CH1 to CH7 =  $0.3\text{V}$ ,  $R_L = 10 \text{ k}\Omega$  to  $V_{DD}/2$ , and  $C_L = 60 \text{ pF}$ .



**FIGURE 2-13:** PSRR vs. Ambient Temperature.



**FIGURE 2-16:** PSRR vs. Frequency.



**FIGURE 2-14:** Input Bias Current vs. Ambient Temperature.



**FIGURE 2-17:** Input Bias Current vs. Input Voltage.



**FIGURE 2-15:** Bandwidth vs. Capacitive Load.



**FIGURE 2-18:** Gain Peaking vs. Capacitive Load.

# MCP6S21/2/6/8

**Note:** Unless otherwise indicated,  $T_A = +25^\circ\text{C}$ ,  $V_{DD} = +5.0\text{V}$ ,  $V_{SS} = \text{GND}$ ,  $V_{REF} = V_{SS}$ ,  $G = +1\text{ V/V}$ , Input = CH0 =  $(0.3\text{V})/G$ , CH1 to CH7 =  $0.3\text{V}$ ,  $R_L = 10\text{ k}\Omega$  to  $V_{DD}/2$ , and  $C_L = 60\text{ pF}$ .



**FIGURE 2-19:** Gain vs. Frequency.



**FIGURE 2-22:** Quiescent Current vs. Supply Voltage.



**FIGURE 2-20:** Histogram of Quiescent Current in Shutdown Mode.



**FIGURE 2-23:** Quiescent Current in Shutdown Mode vs. Ambient Temperature.



**FIGURE 2-21:** Output Voltage Headroom vs. Output Current.



**FIGURE 2-24:** Output Short Circuit Current vs. Supply Voltage.

**Note:** Unless otherwise indicated,  $T_A = +25^\circ\text{C}$ ,  $V_{DD} = +5.0\text{V}$ ,  $V_{SS} = \text{GND}$ ,  $V_{REF} = V_{SS}$ ,  $G = +1 \text{ V/V}$ , Input = CH0 = (0.3V)/G, CH1 to CH7 = 0.3V,  $R_L = 10 \text{ k}\Omega$  to  $V_{DD}/2$ , and  $C_L = 60 \text{ pF}$ .



**FIGURE 2-25:** THD plus Noise vs. Frequency,  $V_{OUT} = 2 \text{ V}_{P-P}$



**FIGURE 2-28:** THD plus Noise vs. Frequency,  $V_{OUT} = 4 \text{ V}_{P-P}$



**FIGURE 2-26:** Small Signal Pulse Response.



**FIGURE 2-29:** Large Signal Pulse Response.



**FIGURE 2-27:** Channel Select Timing.



**FIGURE 2-30:** Gain Select Timing.

# MCP6S21/2/6/8

**Note:** Unless otherwise indicated,  $T_A = +25^\circ\text{C}$ ,  $V_{DD} = +5.0\text{V}$ ,  $V_{SS} = \text{GND}$ ,  $V_{REF} = V_{SS}$ ,  $G = +1\text{ V/V}$ ,  $\text{Input} = \text{CH0} = (0.3\text{V})/G$ ,  $\text{CH1 to CH7} = 0.3\text{V}$ ,  $R_L = 10\text{ k}\Omega$  to  $V_{DD}/2$ , and  $C_L = 60\text{ pF}$ .



**FIGURE 2-31:** Output Voltage vs. Shutdown Mode.



**FIGURE 2-33:** Output Voltage Swing vs. Frequency.



**FIGURE 2-32:** POR Trip Voltage.



**FIGURE 2-34:** The MCP6S21/2/6/8 family shows no phase reversal under overdrive.

## 3.0 PIN DESCRIPTIONS

The descriptions of the pins are listed in Table 3-1.

**TABLE 3-1: PIN FUNCTION TABLE**

MCP6S21	MCP6S22	MCP6S26	MCP6S28	Symbol	Description
1	1	1	1	$V_{OUT}$	Analog Output
2	2	2	2	CH0	Analog Input
—	3	3	3	CH1	Analog Input
—	—	4	4	CH2	Analog Input
—	—	5	5	CH3	Analog Input
—	—	6	6	CH4	Analog Input
—	—	7	7	CH5	Analog Input
—	—	—	8	CH6	Analog Input
—	—	—	9	CH7	Analog Input
3	—	8	10	$V_{REF}$	External Reference Pin
4	4	9	11	$V_{SS}$	Negative Power Supply
5	5	10	12	$\overline{CS}$	SPI Chip Select
6	6	11	13	SI	SPI Serial Data Input
—	—	12	14	SO	SPI Serial Data Output
7	7	13	15	SCK	SPI Clock Input
8	8	14	16	$V_{DD}$	Positive Power Supply

### 3.1 Analog Output

The output pin ( $V_{OUT}$ ) is a low-impedance voltage source. The selected gain (G), selected input (CH0-CH7) and voltage at  $V_{REF}$  determine its value.

### 3.2 Analog Inputs (CH0 thru CH7)

The inputs CH0 through CH7 connect to the signal sources. They are high-impedance CMOS inputs with low bias currents. The internal MUX selects which one is amplified to the output.

### 3.3 External Reference Voltage ( $V_{REF}$ )

The  $V_{REF}$  pin should be at a voltage between  $V_{SS}$  and  $V_{DD}$  (the MCP6S22 has  $V_{REF}$  tied internally to  $V_{SS}$ ). The voltage at this pin shifts the output voltage.

### 3.4 Power Supply ( $V_{SS}$ and $V_{DD}$ )

The positive power supply pin ( $V_{DD}$ ) is 2.5V to 5.5V higher than the negative power supply pin ( $V_{SS}$ ). For normal operation, the other pins are between  $V_{SS}$  and  $V_{DD}$ .

Typically, these parts are used in a single (positive) supply configuration. In this case,  $V_{SS}$  is connected to ground and  $V_{DD}$  is connected to the supply.  $V_{DD}$  will need a local bypass capacitor (0.1  $\mu$ F) at the  $V_{DD}$  pin. It can share a bulk capacitor with nearby analog parts (typically 2.2  $\mu$ F to 10  $\mu$ F within 4 inches (100 mm) of the  $V_{DD}$  pin).

### 3.5 Digital Inputs

The SPI interface inputs are: Chip Select ( $\overline{CS}$ ), Serial Input (SI) and Serial Clock (SCK). These are Schmitt-triggered, CMOS logic inputs.

### 3.6 Digital Output

The MCP6S26 and MCP6S28 devices have a SPI interface serial output (SO) pin. This is a CMOS push-pull output and does not ever go High-Z. Once the device is deselected (CS goes high), SO is forced low. This feature supports daisy chaining, as explained in Section 5.3, "Daisy Chain Configuration".

# MCP6S21/2/6/8

## 4.0 ANALOG FUNCTIONS

The MCP6S21/2/6/8 family of Programmable Gain Amplifiers (PGA) are based on simple analog building blocks (see Figure 4-1). Each of these blocks will be explained in more detail in the following sub-sections.



FIGURE 4-1: PGA Block Diagram.

## 4.1 Input MUX

The MCP6S21 has one input, the MCP6S22 and MCP6S25 have two inputs, the MCP6S26 has six inputs and the MCP6S28 has eight inputs (see Figure 4-1).

For the lowest input current, float unused inputs. Tying these pins to a voltage near the used channels also works well. For simplicity, they can be tied to  $V_{SS}$  or  $V_{DD}$ , but the input current may increase.

The one channel MCP6S21 has the lowest input bias current, while the eight channel MCP6S28 has the highest. There is about a 2:1 ratio in  $I_B$  between these parts.

## 4.2 Internal Op Amp

The internal op amp provides the right combination of bandwidth, accuracy and flexibility.

### 4.2.1 COMPENSATION CAPACITORS

The internal op amp has three compensation capacitors connected to a switching network. They are selected to give good small signal bandwidth at high gains, and good slew rate (full power bandwidth) at low gains. The change in bandwidth as gain changes is between 2 MHz and 12 MHz. Refer to Table 4-1 for more information.

TABLE 4-1: GAIN VS. INTERNAL COMPENSATION CAPACITOR

Gain (V/V)	Internal Compensation Capacitor	Typical GBWP (MHz)	Typical SR (V/ $\mu$ s)	Typical FPBW (MHz)	Typical BW (MHz)
1	Large	12	4.0	0.30	12
2	Large	12	4.0	0.30	6
4	Medium	20	11	0.70	10
5	Medium	20	11	0.70	7
8	Medium	20	11	0.70	2.4
10	Medium	20	11	0.70	2.0
16	Small	64	22	1.6	5
32	Small	64	22	1.6	2.0

**Note 1:** FPBW is the Full Power Bandwidth. These numbers are based on  $V_{DD} = 5.0V$ .

**Note 2:** No changes in DC performance (e.g.,  $V_{OS}$ ) accompany a change in compensation capacitor.

**Note 3:** BW is the closed-loop, small signal -3 dB bandwidth.



## 4.2.2 RAIL-TO-RAIL INPUT

The input stage of the internal op amp uses two differential input stages in parallel; one operates at low  $V_{IN}$  (input voltage), while the other operates at high  $V_{IN}$ . With this topology, the internal inputs can operate to 0.3V past either supply rail. The input offset voltage is measured at both  $V_{IN} = V_{SS} - 0.3V$  and  $V_{DD} + 0.3V$  to ensure proper operation.

The transition between the two input stages occurs when  $V_{IN} \approx V_{DD} - 1.5V$ . For the best distortion and gain linearity, avoid this region of operation.

## 4.2.3 RAIL-TO-RAIL OUTPUT

The Maximum Output Voltage Swing is the maximum swing possible under a particular output load. According to the specification table, the output can reach within 60 mV of either supply rail when  $R_L = 10\text{ k}\Omega$  and  $V_{REF} = V_{DD}/2$ . See Figure 2-21 for typical performance under other conditions.

## 4.2.4 INPUT VOLTAGE AND PHASE REVERSAL

The amplifier family is designed with CMOS input devices. It is designed to not exhibit phase inversion when the input pins exceed the supply voltages. Figure 2-34 shows an input voltage exceeding both supplies with no resulting phase inversion.

The maximum voltage that can be applied to the input pins (CHX) is  $V_{SS} - 0.3V$  to  $V_{DD} + 0.3V$ . Voltages on the inputs that exceed this absolute maximum rating can cause excessive current to flow in or out of the input pins. Current beyond  $\pm 2\text{ mA}$  can cause possible reliability problems. Applications that exceed this rating must be externally limited with an input resistor, as shown in Figure 4-2.

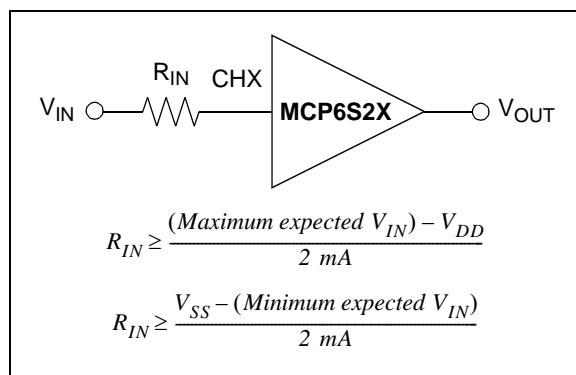

**FIGURE 4-2:**  $R_{IN}$  limits the current flow into an input pin.

## 4.3 Resistor Ladder

The resistor ladder shown in Figure 4-1 ( $R_{LAD} = R_F + R_G$ ) sets the gain. Placing the gain switches in series with the inverting input reduces the parasitic capacitance, distortion and gain mismatch.

$R_{LAD}$  is an additional load on the output of the PGA and causes additional current draw from the supplies.

In Shutdown mode,  $R_{LAD}$  is still attached to the OUT and  $V_{REF}$  pins. Thus, these pins and the internal amplifier's inverting input are all connected through  $R_{LAD}$  and the output is not high-Z (unlike the external op amp).

While  $R_{LAD}$  contributes to the output noise, its effect is small. Refer to Figure 2-12.

## 4.4 Shutdown Mode

These PGAs use a software shutdown command. When the SPI interface sends a shutdown command, the internal op amp is shut down and its output placed in a high-Z state.

The resistive ladder is always connected between  $V_{REF}$  and  $V_{OUT}$ ; even in shutdown. This means that the output resistance will be on the order of 5 k $\Omega$  and there will be a path for output signals to appear at the input.

The Power-on Reset (POR) circuitry will temporarily place the part in shutdown when activated. See Section 5.4, "Power-On Reset", for details.

# MCP6S21/2/6/8

## 5.0 DIGITAL FUNCTIONS

The MCP6S21/2/6/8 PGAs use a standard SPI compatible serial interface to receive instructions from a controller. This interface is configured to allow daisy chaining with other SPI devices. There is an internal POR (Power On Reset) that resets the registers under low power conditions.

### 5.1 SPI Timing

Chip Select ( $\overline{CS}$ ) toggles low to initiate communication with these devices. The first byte of each SI word (two bytes long) is the instruction byte, which goes into the Instruction Register. The Instruction Register points the second byte to its destination. In a typical application,

$\overline{CS}$  is raised after one word (16 bits) to implement the desired changes. Section 5.3, "Registers", covers applications using multiple 16-bit words. SO goes low after  $\overline{CS}$  goes high; it has a push-pull output that does not go into a high-Z state.

The MCP6S21/2/6/8 devices operate in SPI Modes 0,0 and 1,1. In 0,0 mode, the clock idles in the low state (Figure 5-1) and, in 1,1 mode, the clock idles in the high state (Figure 5-2). In both modes, SI data is loaded into the PGA on the rising edge of SCK and SO data is clocked out on the falling edge of SCK. In 0,0 mode, the falling edge of  $\overline{CS}$  also acts as the first falling edge of SCK (see Figure 5-1). There must be multiples of 16 clocks (SCK) while  $\overline{CS}$  is low or commands will abort (see Section 5.3, "Registers").



**FIGURE 5-1:** Serial bus sequence for the PGA; SPI 0,0 mode (see Figure 1-5).



**FIGURE 5-2:** Serial bus sequence for the PGA; SPI 1,1 mode (see Figure 1-6).

## 5.2 Registers

The analog functions are programmed through the SPI interface using 16-bit words (see Figure 5-1 and Figure 5-2). This data is sent to two of three 8-bit registers: Instruction Register (Register 5-1), Gain Register (Register 5-2) and Channel Register (Register 5-3). The power-up defaults for these three registers are:

- Instruction Register: 000x xxx0
- Gain Register: xxxx x000
- Channel Register: xxxx x000

Thus, these devices are initially programmed with the Instruction Register set for NOP (no operation), a gain of +1 V/V and CH0 as the input channel.

### 5.2.1 INSTRUCTION REGISTER

The Instruction Register has 3 command bits and 1 indirect address bit; see Register 5-1. The command bits include a NOP (000) to support daisy chaining (see Section 5.3, "Registers"); the other NOP commands shown should not be used (they are reserved for future use). The device is brought out of Shutdown mode when a valid command, other than NOP or Shutdown, is sent and  $\overline{CS}$  is raised.

#### REGISTER 5-1: INSTRUCTION REGISTER

W-0	W-0	W-0	U-x	U-x	U-x	U-x	W-0
M2	M1	M0	—	—	—	—	A0
bit 7							bit 0

bit 7-5

#### M2-M0: Command Bits

000 = NOP (Default) (**Note 1**)

001 = PGA enters Shutdown Mode as soon as a full 16-bit word is sent and  $\overline{CS}$  is raised. (**Notes 1 and 2**)

010 = Write to register.

011 = NOP (reserved for future use) (**Note 1**)

1XX = NOP (reserved for future use) (**Note 1**)

bit 4-1

**Unimplemented:** Read as '0' (reserved for future use)

bit 0

#### A0: Indirect Address Bit

1 = Addresses the Channel Register

0 = Addresses the Gain Register (Default)

**Note 1:** All other bits in the 16-bit word (including A0) are "don't cares".

**2:** The device exits Shutdown mode when a valid command (other than NOP or Shutdown) is sent and  $\overline{CS}$  is raised; that valid command will be executed. Shutdown does not toggle.

#### Legend:

R = Readable bit

W = Writable bit

U = Unimplemented bit, read as '0'

-n = Value at POR

'1' = Bit is set

'0' = Bit is cleared

x = Bit is unknown

# MCP6S21/2/6/8

## 5.2.2 SETTING THE GAIN

The amplifier can be programmed to produce binary and decimal gain settings between +1 V/V and +32 V/V. Register 5-2 shows the details. At the same time, different compensation capacitors are selected to optimize the bandwidth vs. slew rate trade-off (see Table 4-1).

### REGISTER 5-2: GAIN REGISTER

U-x	U-x	U-x	U-x	U-x	W-0	W-0	W-0
—	—	—	—	—	G2	G1	G0
bit 7					bit 0		

bit 7-3 **Unimplemented:** Read as '0' (reserved for future use)

bit 2-0 **G2-G0: Gain Select Bits**  
000 = Gain of +1 (Default)  
001 = Gain of +2  
010 = Gain of +4  
011 = Gain of +5  
100 = Gain of +8  
101 = Gain of +10  
110 = Gain of +16  
111 = Gain of +32

<b>Legend:</b>			
R = Readable bit	W = Writable bit	U = Unimplemented bit, read as '0'	
-n = Value at POR	'1' = Bit is set	'0' = Bit is cleared	x = Bit is unknown

## 5.2.3 CHANGING THE CHANNEL

If the instruction register is programmed to address the channel register, the multiplexed inputs of the MCP6S22, MCP6S26 and MCP6S28 can be changed per Register 5-3.

### REGISTER 5-3: CHANNEL REGISTER

U-x	U-x	U-x	U-x	U-x	W-0	W-0	W-0
—	—	—	—	—	C2	C1	C0
bit 7					bit 0		

bit 7-3 **Unimplemented:** Read as '0' (reserved for future use)

bit 2-0 **C2-C0: Channel Select Bits**

	<b>MCP6S21</b>	<b>MCP6S22</b>	<b>MCP6S26</b>	<b>MCP6S28</b>
000 = CH0 (Default)	CH0 (Default)	CH0 (Default)	CH0 (Default)	CH0 (Default)
001 = CH0	CH1	CH1	CH1	CH1
010 = CH0	CH0	CH0	CH2	CH2
011 = CH0	CH1	CH1	CH3	CH3
100 = CH0	CH0	CH0	CH4	CH4
101 = CH0	CH1	CH1	CH5	CH5
110 = CH0	CH0	CH0	CH0	CH6
111 = CH0	CH1	CH1	CH0	CH7

**Legend:**

R = Readable bit	W = Writable bit	U = Unimplemented bit, read as '0'
-n = Value at POR	'1' = Bit is set	'0' = Bit is cleared    x = Bit is unknown

# MCP6S21/2/6/8

## 5.2.4 SHUTDOWN COMMAND

The software Shutdown command allows the user to put the amplifier into a low power mode (see Register 5-1). In this shutdown mode, most pins are high impedance (Section 4.4, "Shutdown Mode", and Section 5.1, "SPI Timing", cover the exceptions at pins  $V_{REF}$ ,  $V_{OUT}$  and SO).

Once the PGA has entered shutdown mode, it will remain in this mode until either a valid command is sent to the device (other than NOP or Shutdown), or the device is powered down and back up again. The internal registers maintain their values while in shutdown.

Once brought out of shutdown mode, the part comes back to its previous state (see Section 5.4 for exceptions to this rule). This makes it possible to bring the device out of shutdown mode using one command; send a command to select the current channel (or gain) and the device will exit shutdown with the same state that existed before shutdown.

## 5.3 Daisy Chain Configuration

Multiple devices can be connected in a daisy chain configuration by connecting the SO pin from one device to the SI pin on the next device and using common SCK and  $\overline{CS}$  lines (Figure 5-3). This approach reduces PCB layout complexity.

The example in Figure 5-3 shows a daisy chain configuration with two devices, although any number of devices can be configured this way. The MCP6S21 and MCP6S22 can only be used at the far end of the daisy chain because they do not have a serial data out (SO) pin. As shown in Figure 5-4 and Figure 5-5, both SI and SO data are sent in 16-bit (2 byte) words. These devices abort any command that is not a multiple of 16 bits.

When using the daisy chain configuration, the maximum clock speed possible is reduced to  $\approx 5.8$  MHz because of the SO pin's propagation delay (see Electrical Specifications).

The internal SPI shift register is automatically loaded with zeros whenever  $\overline{CS}$  goes high (a command is executed). Thus, the first 16-bits out of the SO pin once  $\overline{CS}$  line goes low are always zeros. This means that the first command loaded into the next device in the daisy chain is a NOP. This feature makes it possible to send shorter command and data byte strings when the farthest devices do not need to change. For example, if there were three devices on the chain and only the middle device needed changing, only 32 bytes of data need to be transmitted (for the first and middle devices), and the last device on the chain would receive a NOP when the  $\overline{CS}$  pin is raised to execute the command.



**FIGURE 5-3:** Daisy Chain Configuration.



**FIGURE 5-4:** Serial bus sequence for daisy-chain configuration; SPI 0,0 mode.



**FIGURE 5-5:** Serial bus sequence for daisy-chain configuration; SPI 1,1 mode.

## 5.4 Power-On Reset

If the power supply voltage goes below the POR trip voltage ( $V_{DD} < V_{POR} \approx 1.7V$ ), the internal POR circuit will reset all of the internal registers to their power-up defaults (this is a protection against low power supply voltages). The POR circuit also holds the part in shutdown mode while it is activated. It temporarily overrides the software shutdown status. The POR releases the shutdown circuitry once it is released ( $V_{DD} > V_{POR}$ ).

A 0.1  $\mu F$  bypass capacitor mounted as close as possible to the  $V_{DD}$  pin provides additional transient immunity.



## 6.0 APPLICATIONS INFORMATION

### 6.1 Changing External Reference Voltage

Figure 6-1 shows a MCP6S21 with the  $V_{REF}$  pin at 2.5V and  $V_{DD} = 5.0V$ . This allows the PGA to amplify signals centered on 2.5V, instead of ground-referenced signals. The voltage reference MCP1525 is buffered by a MCP6021, which gives a low output impedance reference voltage from DC to high frequencies. The source driving the  $V_{REF}$  pin should have an output impedance of  $\leq 0.1\Omega$  to maintain reasonable gain accuracy.



**FIGURE 6-1:** PGA with Different External Reference Voltage.

### 6.2 Capacitive Load and Stability

Large capacitive loads can cause both stability problems and reduced bandwidth for the MCP6S21/2/6/8 family of PGAs (Figure 2-17 and Figure 2-18). This happens because a large load capacitance decreases the internal amplifier's phase margin and bandwidth.

If the PGA drives a large capacitive load, the circuit in Figure 6-2 can be used. A small series resistor ( $R_{ISO}$ ) at the  $V_{OUT}$  improves the phase margin by making the load resistive at high frequencies. It will not, however, improve the bandwidth.



**FIGURE 6-2:** PGA Circuit for Large Capacitive Loads.

For  $C_L \geq 100$  pF, a good estimate for  $R_{ISO}$  is  $50\Omega$ . This value can be fine-tuned on the bench. Adjust  $R_{ISO}$  so that the step response overshoot and frequency response peaking are acceptable at all gains.

### 6.3 Layout Considerations

Good PC board layout techniques will help achieve the performance shown in the Electrical Characteristics and Typical Performance Curves. It will also help minimize EMC (Electro-Magnetic Compatibility) issues.

#### 6.3.1 COMPONENT PLACEMENT

Separate circuit functions; digital from analog, low speed from high speed, and low power from high power, as this will reduce crosstalk.

Keep sensitive traces short and straight, separating them from interfering components and traces. This is especially important for high frequency (low rise time) signals.

Use a  $0.1 \mu F$  supply bypass capacitor within 0.1 inch (2.5 mm) of the  $V_{DD}$  pin. It must connect directly to the ground plane. A multi-layer ceramic chip capacitor, or high-frequency equivalent, works best.

#### 6.3.2 SIGNAL COUPLING

The input pins of the MCP6S21/2/6/8 family of operational amplifiers (op amps) are high-impedance. This makes them especially susceptible to capacitively-coupled noise. Using a ground plane helps reduce this problem.

When noise is capacitively-coupled, the ground plane provides additional shunt capacitance to ground. When noise is magnetically coupled, the ground plane reduces the mutual inductance between traces. Increasing the separation between traces makes a significant difference.

Changing the direction of one of the traces can also reduce magnetic coupling. It may help to locate guard traces next to the victim trace. They should be on both sides of the victim trace and be as close as possible. Connect the guard traces to the ground plane at both ends, and in the middle, of long traces.

#### 6.3.3 HIGH FREQUENCY ISSUES

Because the MCP6S21/2/6/8 PGAs reach unity gain near 64 MHz when  $G = 16$  and 32, it is important to use good PCB layout techniques. Any parasitic coupling at high frequency might cause undesired peaking. Filtering high frequency signals (i.e., fast edge rates) can help. To minimize high frequency problems:

- Use complete ground and power planes
- Use HF, surface mount components
- Provide clean supply voltages and bypassing
- Keep traces short and straight
- Try a linear power supply (e.g., an LDO)

# MCP6S21/2/6/8

## 6.4 Typical Applications

### 6.4.1 GAIN RANGING

Figure 6-3 shows a circuit that measures the current  $I_X$ . It benefits from changing the gain on the PGA. Just as a hand-held multimeter uses different measurement ranges to obtain the best results, this circuit makes it easy to set a high gain for small signals and a low gain for large signals. As a result, the required dynamic range at the PGA's output is less than at its input (by up to 30 dB).



**FIGURE 6-3:** Wide Dynamic Range Current Measurement Circuit.

### 6.4.2 SHIFTED GAIN RANGE PGA

Figure 6-4 shows a circuit using an MCP6021 at a gain of +10 in front of an MCP6S21. This changes the overall gain range to +10 V/V to +320 V/V (from +1 V/V to +32 V/V).



**FIGURE 6-4:** PGA with Modified Gain Range.

It is also easy to shift the gain range to lower gains (see Figure 6-6). The MCP6021 acts as a unity gain buffer, and the resistive voltage divider shifts the gain range down to +0.1 V/V to +3.2 V/V (from +1 V/V to +32 V/V).



**FIGURE 6-5:** PGA with lower gain range.

### 6.4.3 EXTENDED GAIN RANGE PGA

Figure 6-6 gives a +1 V/V to +1024 V/V gain range, which is much greater than the range for a single PGA (+1 V/V to +32 V/V). The first PGA provides input multiplexing capability, while the second PGA only needs one input. These devices can be daisy chained (Section 5.3, "Daisy Chain Configuration").



**FIGURE 6-6:** PGA with Extended Gain Range.

### 6.4.4 MULTIPLE SENSOR AMPLIFIER

The multiple channel PGAs (except the MCP6S21) allow the user to select which sensor appears on the output (see Figure 6-7). These devices can also change the gain to optimize performance for each sensor.



**FIGURE 6-7:** PGA with Multiple Sensor Inputs.

## 6.4.5 EXPANDED INPUT PGA

Figure 6-8 shows cascaded MCP6S28s that provide up to 15 input channels. Obviously, Sensors #7-14 have a high total gain range available, as explained in Section 6.4.3, "Extended Gain Range". These devices can be daisy chained (Section 5.3, "Daisy Chain Configuration").



**FIGURE 6-8:** PGA with Expanded Inputs.

## 6.4.6 PIC MCU WITH EXPANDED INPUT CAPABILITY

Figure 6-9 shows an MCP6S28 driving an analog input to a PIC microcontroller. This greatly expands the input capacity of the microcontroller, while adding the ability to select the appropriate gain for each source.



**FIGURE 6-9:** Expanded Input for a PIC<sup>®</sup> Microcontroller.

## 6.4.7 ADC DRIVER

The family of PGA's is well suited for driving Analog-to-Digital Converters (ADC). The binary gains (1, 2, 4, 8, 16 and 32) effectively add five more bits to the input range (see Figure 6-10). This works well for applications needing relative accuracy more than absolute accuracy (e.g., power monitoring).



**FIGURE 6-10:** PGA as an ADC Driver.

At low gains, the ADC's Signal-to-Noise Ratio (SNR) will dominate since the PGAs input noise voltage density is so low (10 nV/ $\sqrt{\text{Hz}}$  @ 10 kHz, typ.). At high gains, the PGA's noise will dominate the SNR, but its low noise supports most applications. Again, these PGAs add the flexibility of selecting the best gain for an application.

The low pass filter in the block diagram reduces the integrated noise at the MCP6S28's output and serves as an anti-aliasing filter. This filter may be designed using Microchip's FilterLab<sup>®</sup> software, available at [www.microchip.com](http://www.microchip.com).

# MCP6S21/2/6/8

## 7.0 PACKAGING INFORMATION

### 7.1 Package Marking Information

8-Lead PDIP (300 mil) (MCP6S21, MCP6S22)



Example:



8-Lead SOIC (150 mil) (MCP6S21, MCP6S22)



Example:



8-Lead MSOP (MCP6S21, MCP6S22)



Example:

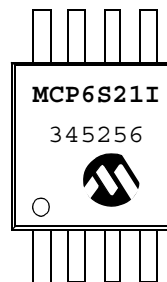

<b>Legend:</b>	XX...X	Customer specific information*
	YY	Year code (last 2 digits of calendar year)
	WW	Week code (week of January 1 is week '01')
	NNN	Alphanumeric traceability code

<b>Note:</b>	In the event the full Microchip part number cannot be marked on one line, it will be carried over to the next line thus limiting the number of available characters for customer specific information.
--------------	--

\* Standard marking consists of Microchip part number, year code, week code, traceability code (facility code, mask rev#, and assembly code). For marking beyond this, certain price adders apply. Please check with your Microchip Sales Office.

## Package Marking Information (Con't)

14-Lead PDIP (300 mil) (MCP6S26)



Example:



14-Lead SOIC (150 mil) (MCP6S26)

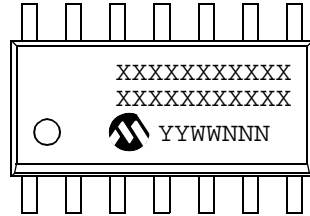

Example:

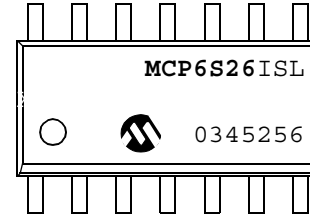

14-Lead TSSOP (4.4mm) (MCP6S26)

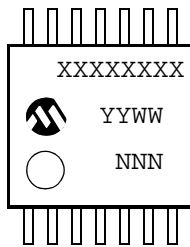

Example:



# MCP6S21/2/6/8

---

## Package Marking Information (Con't)

16-Lead PDIP (300 mil) (**MCP6S28**)



Example:

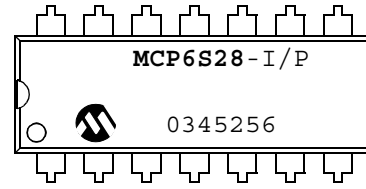

16-Lead SOIC (150 mil) (**MCP6S28**)



Example:

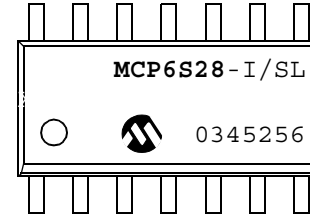

## 8-Lead Plastic Dual In-line (P) – 300 mil (PDIP)

**Note:** For the most current package drawings, please see the Microchip Packaging Specification located at <http://www.microchip.com/packaging>



Units		INCHES*			MILLIMETERS		
Dimension Limits		MIN	NOM	MAX	MIN	NOM	MAX
Number of Pins	n		8			8	
Pitch	p		.100			2.54	
Top to Seating Plane	A	.140	.155	.170	3.56	3.94	4.32
Molded Package Thickness	A2	.115	.130	.145	2.92	3.30	3.68
Base to Seating Plane	A1	.015			0.38		
Shoulder to Shoulder Width	E	.300	.313	.325	7.62	7.94	8.26
Molded Package Width	E1	.240	.250	.260	6.10	6.35	6.60
Overall Length	D	.360	.373	.385	9.14	9.46	9.78
Tip to Seating Plane	L	.125	.130	.135	3.18	3.30	3.43
Lead Thickness	c	.008	.012	.015	0.20	0.29	0.38
Upper Lead Width	B1	.045	.058	.070	1.14	1.46	1.78
Lower Lead Width	B	.014	.018	.022	0.36	0.46	0.56
Overall Row Spacing	§ eB	.310	.370	.430	7.87	9.40	10.92
Mold Draft Angle Top	α	5	10	15	5	10	15
Mold Draft Angle Bottom	β	5	10	15	5	10	15

\* Controlling Parameter  
 § Significant Characteristic

Notes:  
 Dimensions D and E1 do not include mold flash or protrusions. Mold flash or protrusions shall not exceed .010" (0.254mm) per side.  
 JEDEC Equivalent: MS-001  
 Drawing No. C04-018

# MCP6S21/2/6/8

## 8-Lead Plastic Small Outline (SN) – Narrow, 150 mil (SOIC)

**Note:** For the most current package drawings, please see the Microchip Packaging Specification located at <http://www.microchip.com/packaging>



Units		INCHES*			MILLIMETERS		
Dimension Limits		MIN	NOM	MAX	MIN	NOM	MAX
Number of Pins	n		8			8	
Pitch	p		.050			1.27	
Overall Height	A	.053	.061	.069	1.35	1.55	1.75
Molded Package Thickness	A2	.052	.056	.061	1.32	1.42	1.55
Standoff §	A1	.004	.007	.010	0.10	0.18	0.25
Overall Width	E	.228	.237	.244	5.79	6.02	6.20
Molded Package Width	E1	.146	.154	.157	3.71	3.91	3.99
Overall Length	D	.189	.193	.197	4.80	4.90	5.00
Chamfer Distance	h	.010	.015	.020	0.25	0.38	0.51
Foot Length	L	.019	.025	.030	0.48	0.62	0.76
Foot Angle	φ	0	4	8	0	4	8
Lead Thickness	c	.008	.009	.010	0.20	0.23	0.25
Lead Width	B	.013	.017	.020	0.33	0.42	0.51
Mold Draft Angle Top	α	0	12	15	0	12	15
Mold Draft Angle Bottom	β	0	12	15	0	12	15

\* Controlling Parameter  
 § Significant Characteristic

Notes:  
 Dimensions D and E1 do not include mold flash or protrusions. Mold flash or protrusions shall not exceed .010" (0.254mm) per side.  
 JEDEC Equivalent: MS-012  
 Drawing No. C04-057



## 8-Lead Plastic Micro Small Outline Package (MS) (MSOP)

**Note:** For the most current package drawings, please see the Microchip Packaging Specification located at <http://www.microchip.com/packaging>



Dimension Limits	Units	INCHES			MILLIMETERS*		
		MIN	NOM	MAX	MIN	NOM	MAX
Number of Pins	n		8				8
Pitch	P	.026			0.65		
Overall Height	A			.044			1.18
Molded Package Thickness	A2	.030	.034	.038	0.76	0.86	0.97
Standoff §	A1	.002		.006	0.05		0.15
Overall Width	E	.184	.193	.200	4.67	4.90	5.08
Molded Package Width	E1	.114	.118	.122	2.90	3.00	3.10
Overall Length	D	.114	.118	.122	2.90	3.00	3.10
Foot Length	L	.016	.022	.028	0.40	0.55	0.70
Footprint (Reference)	F	.035	.037	.039	0.90	0.95	1.00
Foot Angle	φ	0		6	0		6
Lead Thickness	c	.004	.006	.008	0.10	0.15	0.20
Lead Width	B	.010	.012	.016	0.25	0.30	0.40
Mold Draft Angle Top	α		7			7	
Mold Draft Angle Bottom	β		7			7	

\*Controlling Parameter  
§ Significant Characteristic

**Notes:**

Dimensions D and E1 do not include mold flash or protrusions. Mold flash or protrusions shall not exceed .010" (0.254mm) per side.

Drawing No. C04-111

# MCP6S21/2/6/8

## 14-Lead Plastic Dual In-line (P) – 300 mil (PDIP)

**Note:** For the most current package drawings, please see the Microchip Packaging Specification located at <http://www.microchip.com/packaging>



Units		INCHES*			MILLIMETERS		
Dimension Limits		MIN	NOM	MAX	MIN	NOM	MAX
Number of Pins	n		14			14	
Pitch	p		.100			2.54	
Top to Seating Plane	A	.140	.155	.170	3.56	3.94	4.32
Molded Package Thickness	A2	.115	.130	.145	2.92	3.30	3.68
Base to Seating Plane	A1	.015			0.38		
Shoulder to Shoulder Width	E	.300	.313	.325	7.62	7.94	8.26
Molded Package Width	E1	.240	.250	.260	6.10	6.35	6.60
Overall Length	D	.740	.750	.760	18.80	19.05	19.30
Tip to Seating Plane	L	.125	.130	.135	3.18	3.30	3.43
Lead Thickness	c	.008	.012	.015	0.20	0.29	0.38
Upper Lead Width	B1	.045	.058	.070	1.14	1.46	1.78
Lower Lead Width	B	.014	.018	.022	0.36	0.46	0.56
Overall Row Spacing	§ eB	.310	.370	.430	7.87	9.40	10.92
Mold Draft Angle Top	α	5	10	15	5	10	15
Mold Draft Angle Bottom	β	5	10	15	5	10	15

\* Controlling Parameter

§ Significant Characteristic

Notes:

Dimensions D and E1 do not include mold flash or protrusions. Mold flash or protrusions shall not exceed

.010" (0.254mm) per side.

JEDEC Equivalent: MS-001

Drawing No. C04-005

## 14-Lead Plastic Small Outline (SL) – Narrow, 150 mil (SOIC)

**Note:** For the most current package drawings, please see the Microchip Packaging Specification located at <http://www.microchip.com/packaging>



Units		INCHES*			MILLIMETERS		
Dimension	Limits	MIN	NOM	MAX	MIN	NOM	MAX
Number of Pins	n		14			14	
Pitch	P		.050			1.27	
Overall Height	A	.053	.061	.069	1.35	1.55	1.75
Molded Package Thickness	A2	.052	.056	.061	1.32	1.42	1.55
Standoff §	A1	.004	.007	.010	0.10	0.18	0.25
Overall Width	E	.228	.236	.244	5.79	5.99	6.20
Molded Package Width	E1	.150	.154	.157	3.81	3.90	3.99
Overall Length	D	.337	.342	.347	8.56	8.69	8.81
Chamfer Distance	h	.010	.015	.020	0.25	0.38	0.51
Foot Length	L	.016	.033	.050	0.41	0.84	1.27
Foot Angle	φ	0	4	8	0	4	8
Lead Thickness	c	.008	.009	.010	0.20	0.23	0.25
Lead Width	B	.014	.017	.020	0.36	0.42	0.51
Mold Draft Angle Top	α	0	12	15	0	12	15
Mold Draft Angle Bottom	β	0	12	15	0	12	15

\* Controlling Parameter  
 § Significant Characteristic

**Notes:**

Dimensions D and E1 do not include mold flash or protrusions. Mold flash or protrusions shall not exceed .010" (0.254mm) per side.  
 JEDEC Equivalent: MS-012  
 Drawing No. C04-065

# MCP6S21/2/6/8

## 14-Lead Plastic Thin Shrink Small Outline (ST) – 4.4 mm (TSSOP)

**Note:** For the most current package drawings, please see the Microchip Packaging Specification located at <http://www.microchip.com/packaging>



Dimension Limits	Units	INCHES			MILLIMETERS*		
		MIN	NOM	MAX	MIN	NOM	MAX
Number of Pins	n		14			14	
Pitch	p		.026			0.65	
Overall Height	A			.043			1.10
Molded Package Thickness	A2	.033	.035	.037	0.85	0.90	0.95
Standoff §	A1	.002	.004	.006	0.05	0.10	0.15
Overall Width	E	.246	.251	.256	6.25	6.38	6.50
Molded Package Width	E1	.169	.173	.177	4.30	4.40	4.50
Molded Package Length	D	.193	.197	.201	4.90	5.00	5.10
Foot Length	L	.020	.024	.028	0.50	0.60	0.70
Foot Angle	φ	0	4	8	0	4	8
Lead Thickness	c	.004	.006	.008	0.09	0.15	0.20
Lead Width	B1	.007	.010	.012	0.19	0.25	0.30
Mold Draft Angle Top	α	0	5	10	0	5	10
Mold Draft Angle Bottom	β	0	5	10	0	5	10

\* Controlling Parameter

§ Significant Characteristic

**Notes:**

Dimensions D and E1 do not include mold flash or protrusions. Mold flash or protrusions shall not exceed .005" (0.127mm) per side.

JEDEC Equivalent: MO-153

Drawing No. C04-087

## 16-Lead Plastic Dual In-line (P) – 300 mil (PDIP)

**Note:** For the most current package drawings, please see the Microchip Packaging Specification located at <http://www.microchip.com/packaging>

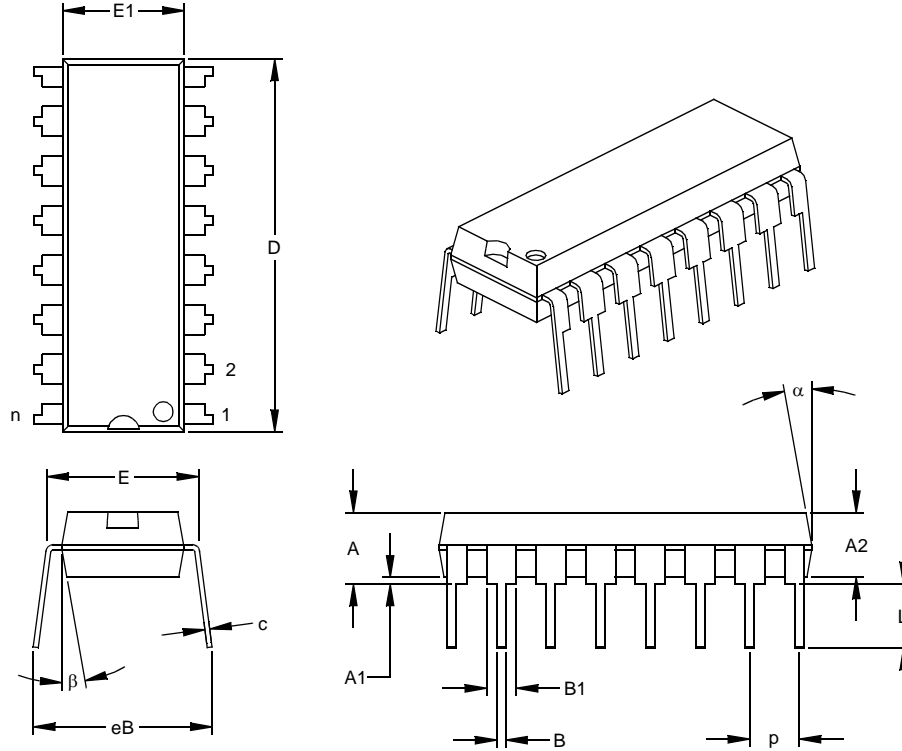

Units		INCHES*			MILLIMETERS		
Dimension Limits		MIN	NOM	MAX	MIN	NOM	MAX
Number of Pins	n		16			16	
Pitch	P		.100			2.54	
Top to Seating Plane	A	.140	.155	.170	3.56	3.94	4.32
Molded Package Thickness	A2	.115	.130	.145	2.92	3.30	3.68
Base to Seating Plane	A1	.015			0.38		
Shoulder to Shoulder Width	E	.300	.313	.325	7.62	7.94	8.26
Molded Package Width	E1	.240	.250	.260	6.10	6.35	6.60
Overall Length	D	.740	.750	.760	18.80	19.05	19.30
Tip to Seating Plane	L	.125	.130	.135	3.18	3.30	3.43
Lead Thickness	c	.008	.012	.015	0.20	0.29	0.38
Upper Lead Width	B1	.045	.058	.070	1.14	1.46	1.78
Lower Lead Width	B	.014	.018	.022	.036	0.46	0.56
Overall Row Spacing	§ eB	.310	.370	.430	7.87	9.40	10.92
Mold Draft Angle Top	α	5	10	15	5	10	15
Mold Draft Angle Bottom	β	5	10	15	5	10	15

\* Controlling Parameter  
 § Significant Characteristic

Notes:  
 Dimensions D and E1 do not include mold flash or protrusions. Mold flash or protrusions shall not exceed .010" (0.254mm) per side.  
 JEDEC Equivalent: MS-001  
 Drawing No. C04-017

# MCP6S21/2/6/8

## 16-Lead Plastic Small Outline (SL) – Narrow 150 mil (SOIC)

**Note:** For the most current package drawings, please see the Microchip Packaging Specification located at <http://www.microchip.com/packaging>



Dimension Limits	Units	INCHES*			MILLIMETERS		
		MIN	NOM	MAX	MIN	NOM	MAX
Number of Pins	n		16			16	
Pitch	P		.050			1.27	
Overall Height	A	.053	.061	.069	1.35	1.55	1.75
Molded Package Thickness	A2	.052	.057	.061	1.32	1.44	1.55
Standoff §	A1	.004	.007	.010	0.10	0.18	0.25
Overall Width	E	.228	.237	.244	5.79	6.02	6.20
Molded Package Width	E1	.150	.154	.157	3.81	3.90	3.99
Overall Length	D	.386	.390	.394	9.80	9.91	10.01
Chamfer Distance	h	.010	.015	.020	0.25	0.38	0.51
Foot Length	L	.016	.033	.050	0.41	0.84	1.27
Foot Angle	φ	0	4	8	0	4	8
Lead Thickness	c	.008	.009	.010	0.20	0.23	0.25
Lead Width	B	.013	.017	.020	0.33	0.42	0.51
Mold Draft Angle Top	α	0	12	15	0	12	15
Mold Draft Angle Bottom	β	0	12	15	0	12	15

\* Controlling Parameter  
 § Significant Characteristic

**Notes:**

Dimensions D and E1 do not include mold flash or protrusions. Mold flash or protrusions shall not exceed .010" (0.254mm) per side.

JEDEC Equivalent: MS-012

Drawing No. C04-108

## PRODUCT IDENTIFICATION SYSTEM

To order or obtain information, e.g., on pricing or delivery, refer to the factory or the listed sales office.

<u>PART NO.</u>	<u>-X</u>	<u>/XX</u>
Device	Temperature Range	Package
Device:	MCP6S21: One Channel PGA MCP6S21T: One Channel PGA (Tape and Reel for SOIC and MSOP)	
	MCP6S22: Two Channel PGA MCP6S22T: Two Channel PGA (Tape and Reel for SOIC and MSOP)	
	MCP6S26: Six Channel PGA MCP6S26T: Six Channel PGA (Tape and Reel for SOIC and TSSOP)	
	MCP6S28: Eight Channel PGA MCP6S28T: Eight Channel PGA (Tape and Reel for SOIC)	
Temperature Range:	I = -40°C to +85°C	
Package:	MS = Plastic Micro Small Outline (MSOP), 8-lead P = Plastic DIP (300 mil Body), 8, 14, and 16-lead SN = Plastic SOIC, (150 mil Body), 8-lead SL = Plastic SOIC (150 mil Body), 14, 16-lead ST = Plastic TSSOP (4.4mm Body), 14-lead	

**Examples:**

- MCP6S21-I/P: One Channel PGA, PDIP package.
- MCP6S21-I/SN: One Channel PGA, SOIC package.
- MCP6S21-I/MS: One Channel PGA, MSOP package.
- MCP6S22-I/MS: Two Channel PGA, MSOP package.
- MCP6S22T-I/MS: Tape and Reel, Two Channel PGA, MSOP package.
- MCP6S26-I/P: Six Channel PGA, PDIP package.
- MCP6S26-I/SN: Six Channel PGA, SOIC package.
- MCP6S26T-I/ST: Tape and Reel, Six Channel PGA, TSSOP package.
- MCP6S28T-I/SL: Tape and Reel, Eight Channel PGA, SOIC package.

## Sales and Support

### Data Sheets

Products supported by a preliminary Data Sheet may have an errata sheet describing minor operational differences and recommended workarounds. To determine if an errata sheet exists for a particular device, please contact one of the following:

- Your local Microchip sales office
- The Microchip Worldwide Site ([www.microchip.com](http://www.microchip.com))

Please specify which device, revision of silicon and Data Sheet (include Literature #) you are using.

### New Customer Notification System

Register on our web site ([www.microchip.com/cn](http://www.microchip.com/cn)) to receive the most current information on our products.

# MCP6S21/2/6/8

---

---

NOTES:



---

**Note the following details of the code protection feature on Microchip devices:**

- Microchip products meet the specification contained in their particular Microchip Data Sheet.
- Microchip believes that its family of products is one of the most secure families of its kind on the market today, when used in the intended manner and under normal conditions.
- There are dishonest and possibly illegal methods used to breach the code protection feature. All of these methods, to our knowledge, require using the Microchip products in a manner outside the operating specifications contained in Microchip's Data Sheets. Most likely, the person doing so is engaged in theft of intellectual property.
- Microchip is willing to work with the customer who is concerned about the integrity of their code.
- Neither Microchip nor any other semiconductor manufacturer can guarantee the security of their code. Code protection does not mean that we are guaranteeing the product as “unbreakable.”

Code protection is constantly evolving. We at Microchip are committed to continuously improving the code protection features of our products. Attempts to break Microchip's code protection feature may be a violation of the Digital Millennium Copyright Act. If such acts allow unauthorized access to your software or other copyrighted work, you may have a right to sue for relief under that Act.

---

Information contained in this publication regarding device applications and the like is provided only for your convenience and may be superseded by updates. It is your responsibility to ensure that your application meets with your specifications. MICROCHIP MAKES NO REPRESENTATIONS OR WARRANTIES OF ANY KIND WHETHER EXPRESS OR IMPLIED, WRITTEN OR ORAL, STATUTORY OR OTHERWISE, RELATED TO THE INFORMATION, INCLUDING BUT NOT LIMITED TO ITS CONDITION, QUALITY, PERFORMANCE, MERCHANTABILITY OR FITNESS FOR PURPOSE. Microchip disclaims all liability arising from this information and its use. Use of Microchip devices in life support and/or safety applications is entirely at the buyer's risk, and the buyer agrees to defend, indemnify and hold harmless Microchip from any and all damages, claims, suits, or expenses resulting from such use. No licenses are conveyed, implicitly or otherwise, under any Microchip intellectual property rights.

#### **Trademarks**

The Microchip name and logo, the Microchip logo, dsPIC, FlashFlex, KEELOQ, KEELOQ logo, MPLAB, PIC, PICmicro, PICSTART, PIC<sup>32</sup> logo, rPIC, SST, SST Logo, SuperFlash and UNI/O are registered trademarks of Microchip Technology Incorporated in the U.S.A. and other countries.

FilterLab, Hampshire, HI-TECH C, Linear Active Thermistor, MTP, SEEVAL and The Embedded Control Solutions Company are registered trademarks of Microchip Technology Incorporated in the U.S.A.

Silicon Storage Technology is a registered trademark of Microchip Technology Inc. in other countries.

Analog-for-the-Digital Age, Application Maestro, BodyCom, chipKIT, chipKIT logo, CodeGuard, dsPICDEM, dsPICDEM.net, dsPICworks, dsSPEAK, ECAN, ECONOMONITOR, FanSense, HI-TIDE, In-Circuit Serial Programming, ICSP, Mindi, MiWi, MPASM, MPF, MPLAB Certified logo, MPLIB, MPLINK, mTouch, Omniclient Code Generation, PICC, PICC-18, PICDEM, PICDEM.net, PICkit, PICtail, REAL ICE, rLAB, Select Mode, SQI, Serial Quad I/O, Total Endurance, TSHARC, UniWinDriver, WiperLock, ZENA and Z-Scale are trademarks of Microchip Technology Incorporated in the U.S.A. and other countries.

SQTP is a service mark of Microchip Technology Incorporated in the U.S.A.

GestIC and ULPP are registered trademarks of Microchip Technology Germany II GmbH & Co. & KG, a subsidiary of Microchip Technology Inc., in other countries.

All other trademarks mentioned herein are property of their respective companies.

© 2003-2012, Microchip Technology Incorporated, Printed in the U.S.A., All Rights Reserved.

 Printed on recycled paper.

ISBN: 9781620767504

**QUALITY MANAGEMENT SYSTEM**  
**CERTIFIED BY DNV**  
**== ISO/TS 16949 ==**

*Microchip received ISO/TS-16949:2009 certification for its worldwide headquarters, design and wafer fabrication facilities in Chandler and Tempe, Arizona; Gresham, Oregon and design centers in California and India. The Company's quality system processes and procedures are for its PIC<sup>®</sup> MCUs and dsPIC<sup>®</sup> DSCs, KEELOQ<sup>®</sup> code hopping devices, Serial EEPROMs, microperipherals, nonvolatile memory and analog products. In addition, Microchip's quality system for the design and manufacture of development systems is ISO 9001:2000 certified.*



# MICROCHIP

## Worldwide Sales and Service

### AMERICAS

**Corporate Office**  
2355 West Chandler Blvd.  
Chandler, AZ 85224-6199  
Tel: 480-792-7200  
Fax: 480-792-7277  
Technical Support:  
<http://www.microchip.com/support>  
Web Address:  
[www.microchip.com](http://www.microchip.com)

**Atlanta**  
Duluth, GA  
Tel: 678-957-9614  
Fax: 678-957-1455

**Boston**  
Westborough, MA  
Tel: 774-760-0087  
Fax: 774-760-0088

**Chicago**  
Itasca, IL  
Tel: 630-285-0071  
Fax: 630-285-0075

**Cleveland**  
Independence, OH  
Tel: 216-447-0464  
Fax: 216-447-0643

**Dallas**  
Addison, TX  
Tel: 972-818-7423  
Fax: 972-818-2924

**Detroit**  
Farmington Hills, MI  
Tel: 248-538-2250  
Fax: 248-538-2260

**Indianapolis**  
Noblesville, IN  
Tel: 317-773-8323  
Fax: 317-773-5453

**Los Angeles**  
Mission Viejo, CA  
Tel: 949-462-9523  
Fax: 949-462-9608

**Santa Clara**  
Santa Clara, CA  
Tel: 408-961-6444  
Fax: 408-961-6445

**Toronto**  
Mississauga, Ontario,  
Canada  
Tel: 905-673-0699  
Fax: 905-673-6509

### ASIA/PACIFIC

**Asia Pacific Office**  
Suites 3707-14, 37th Floor  
Tower 6, The Gateway  
Harbour City, Kowloon  
Hong Kong  
Tel: 852-2401-1200  
Fax: 852-2401-3431

**Australia - Sydney**  
Tel: 61-2-9868-6733  
Fax: 61-2-9868-6755

**China - Beijing**  
Tel: 86-10-8569-7000  
Fax: 86-10-8528-2104

**China - Chengdu**  
Tel: 86-28-8665-5511  
Fax: 86-28-8665-7889

**China - Chongqing**  
Tel: 86-23-8980-9588  
Fax: 86-23-8980-9500

**China - Hangzhou**  
Tel: 86-571-2819-3187  
Fax: 86-571-2819-3189

**China - Hong Kong SAR**  
Tel: 852-2401-1200  
Fax: 852-2401-3431

**China - Nanjing**  
Tel: 86-25-8473-2460  
Fax: 86-25-8473-2470

**China - Qingdao**  
Tel: 86-532-8502-7355  
Fax: 86-532-8502-7205

**China - Shanghai**  
Tel: 86-21-5407-5533  
Fax: 86-21-5407-5066

**China - Shenyang**  
Tel: 86-24-2334-2829  
Fax: 86-24-2334-2393

**China - Shenzhen**  
Tel: 86-755-8203-2660  
Fax: 86-755-8203-1760

**China - Wuhan**  
Tel: 86-27-5980-5300  
Fax: 86-27-5980-5118

**China - Xian**  
Tel: 86-29-8833-7252  
Fax: 86-29-8833-7256

**China - Xiamen**  
Tel: 86-592-2388138  
Fax: 86-592-2388130

**China - Zhuhai**  
Tel: 86-756-3210040  
Fax: 86-756-3210049

### ASIA/PACIFIC

**India - Bangalore**  
Tel: 91-80-3090-4444  
Fax: 91-80-3090-4123

**India - New Delhi**  
Tel: 91-11-4160-8631  
Fax: 91-11-4160-8632

**India - Pune**  
Tel: 91-20-2566-1512  
Fax: 91-20-2566-1513

**Japan - Osaka**  
Tel: 81-66-152-7160  
Fax: 81-66-152-9310

**Japan - Yokohama**  
Tel: 81-45-471-6166  
Fax: 81-45-471-6122

**Korea - Daegu**  
Tel: 82-53-744-4301  
Fax: 82-53-744-4302

**Korea - Seoul**  
Tel: 82-2-554-7200  
Fax: 82-2-558-5932 or  
82-2-558-5934

**Malaysia - Kuala Lumpur**  
Tel: 60-3-6201-9857  
Fax: 60-3-6201-9859

**Malaysia - Penang**  
Tel: 60-4-227-8870  
Fax: 60-4-227-4068

**Philippines - Manila**  
Tel: 63-2-634-9065  
Fax: 63-2-634-9069

**Singapore**  
Tel: 65-6334-8870  
Fax: 65-6334-8850

**Taiwan - Hsin Chu**  
Tel: 886-3-5778-366  
Fax: 886-3-5770-955

**Taiwan - Kaohsiung**  
Tel: 886-7-213-7828  
Fax: 886-7-330-9305

**Taiwan - Taipei**  
Tel: 886-2-2508-8600  
Fax: 886-2-2508-0102

**Thailand - Bangkok**  
Tel: 66-2-694-1351  
Fax: 66-2-694-1350

### EUROPE

**Austria - Wels**  
Tel: 43-7242-2244-39  
Fax: 43-7242-2244-393

**Denmark - Copenhagen**  
Tel: 45-4450-2828  
Fax: 45-4485-2829

**France - Paris**  
Tel: 33-1-69-53-63-20  
Fax: 33-1-69-30-90-79

**Germany - Munich**  
Tel: 49-89-627-144-0  
Fax: 49-89-627-144-44

**Italy - Milan**  
Tel: 39-0331-742611  
Fax: 39-0331-466781

**Netherlands - Drunen**  
Tel: 31-416-690399  
Fax: 31-416-690340

**Spain - Madrid**  
Tel: 34-91-708-08-90  
Fax: 34-91-708-08-91

**UK - Wokingham**  
Tel: 44-118-921-5869  
Fax: 44-118-921-5820

10/26/12



Компания «ЭлектроПласт» предлагает заключение долгосрочных отношений при поставках импортных электронных компонентов на взаимовыгодных условиях!

Наши преимущества:

- Оперативные поставки широкого спектра электронных компонентов отечественного и импортного производства напрямую от производителей и с крупнейших мировых складов;
- Поставка более 17-ти миллионов наименований электронных компонентов;
- Поставка сложных, дефицитных, либо снятых с производства позиций;
- Оперативные сроки поставки под заказ (от 5 рабочих дней);
- Экспресс доставка в любую точку России;
- Техническая поддержка проекта, помощь в подборе аналогов, поставка прототипов;
- Система менеджмента качества сертифицирована по Международному стандарту ISO 9001;
- Лицензия ФСБ на осуществление работ с использованием сведений, составляющих государственную тайну;
- Поставка специализированных компонентов (Xilinx, Altera, Analog Devices, Intersil, Interpoint, Microsemi, Aeroflex, Peregrine, Syfer, Eurofarad, Texas Instrument, Miteq, Cobham, E2V, MA-COM, Hittite, Mini-Circuits, General Dynamics и др.);

Помимо этого, одним из направлений компании «ЭлектроПласт» является направление «Источники питания». Мы предлагаем Вам помощь Конструкторского отдела:

- Подбор оптимального решения, техническое обоснование при выборе компонента;
- Подбор аналогов;
- Консультации по применению компонента;
- Поставка образцов и прототипов;
- Техническая поддержка проекта;
- Защита от снятия компонента с производства.



#### Как с нами связаться

**Телефон:** 8 (812) 309 58 32 (многоканальный)

**Факс:** 8 (812) 320-02-42

**Электронная почта:** [org@eplast1.ru](mailto:org@eplast1.ru)

**Адрес:** 198099, г. Санкт-Петербург, ул. Калинина, дом 2, корпус 4, литера А.