

## CARMEN-50-S-C

~24° spot beam. Assembly with holder C compatible with LEDiL HEKLA.

### TECHNICAL SPECIFICATIONS:

Dimensions	Ø 50.0 mm
Height	25.5 mm
Fastening	socket
ROHS compliant	yes ⓘ

### MATERIAL SPECIFICATIONS:

Component	Type	Material	Colour	Finish
CARMEN-50-S	Single lens	PMMA	clear	
CARMEN-50-HLD-C	Holder	PC	black	



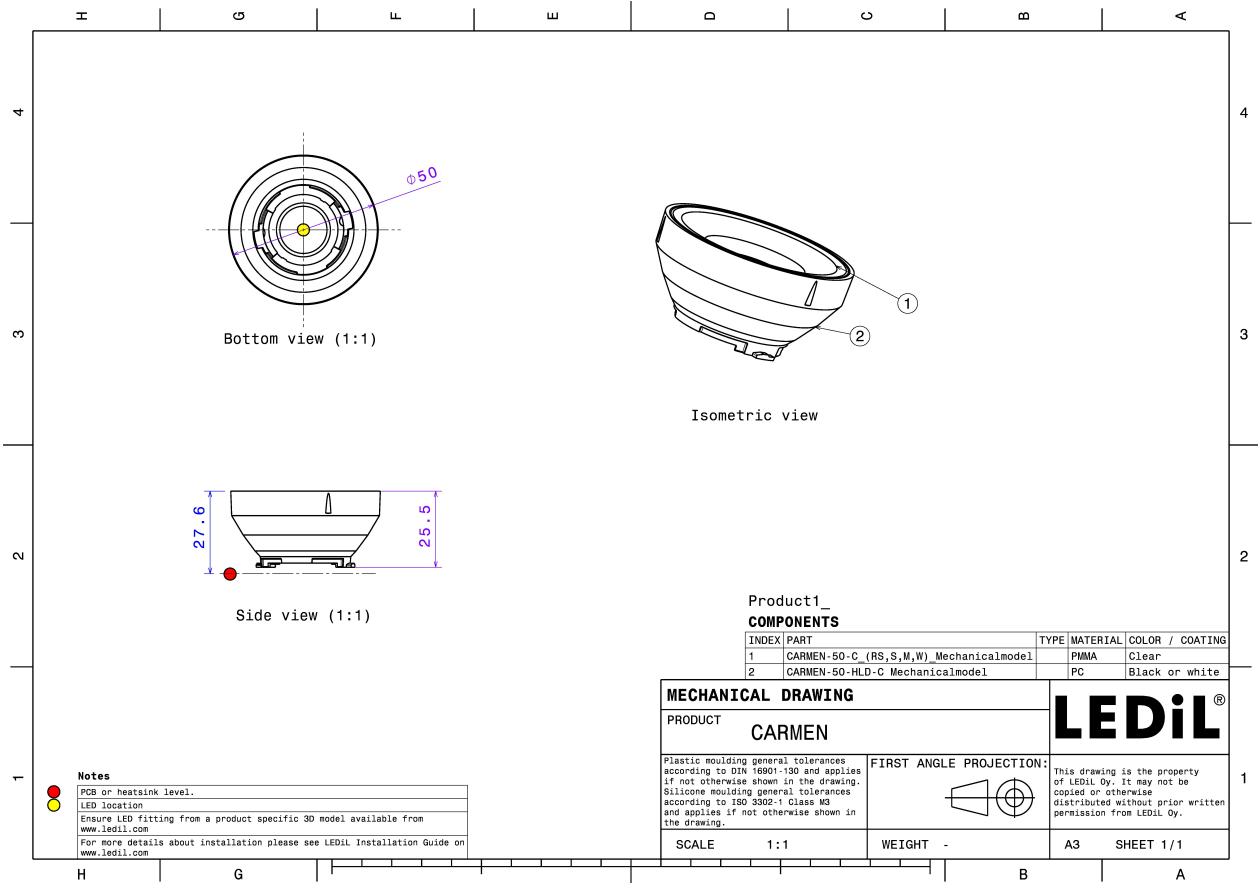

### ORDERING INFORMATION:

Component		Qty in box	MOQ	MPQ	Box weight (kg)
CP16107_CARMEN-50-S-C	Single lens	308	112	28	6.9
» Box size: 476 x 273 x 292 mm					

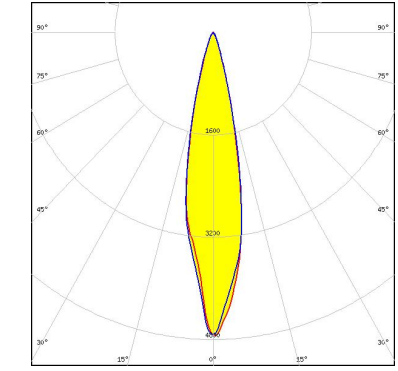
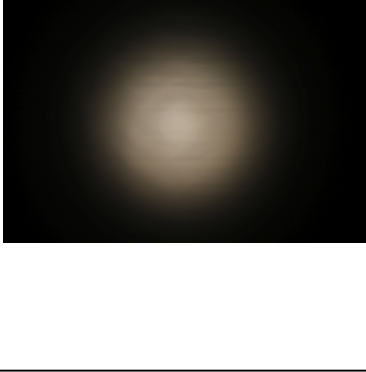
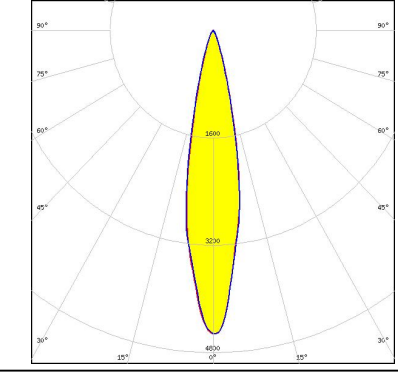
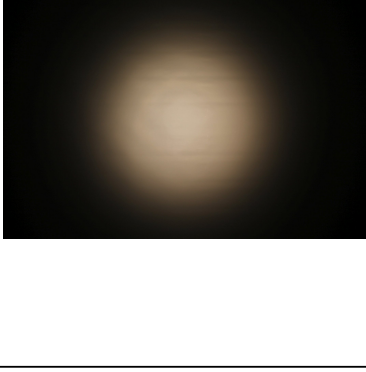
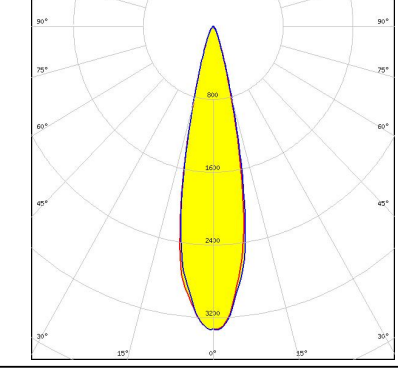

#### PHOTOMETRIC DATA (MEASURED):

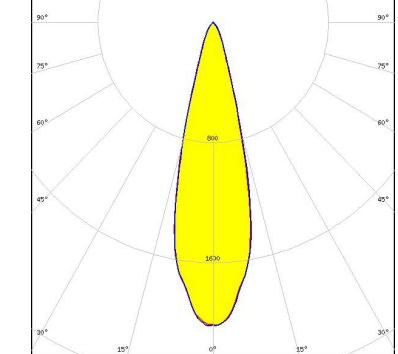
<p>bridgelux.</p> <p>LED V4 HD            FWHM 21.0°            Efficiency 79 %            Peak intensity 4.7 cd/lm            LEDs/each optic 1            Light colour White            Required components:            F15253_HEKLA-SOCKET-A</p>		
<p>bridgelux.</p> <p>LED V6 HD            FWHM 20.0°            Efficiency 73 %            Peak intensity 4.5 cd/lm            LEDs/each optic 1            Light colour White            Required components:            F15255_HEKLA-SOCKET-C</p>		
<p>bridgelux.</p> <p>LED V9 HD            FWHM 23.0°            Efficiency 65 %            Peak intensity 3.3 cd/lm            LEDs/each optic 1            Light colour White            Required components:            F15859_HEKLA-SOCKET-I</p>		
<p>bridgelux.</p> <p>LED VERO13            FWHM 27.0°            Efficiency 53 %            Peak intensity 2 cd/lm            LEDs/each optic 1            Light colour White            Required components:            C16142_HEKLA-SOCKET-K</p>		

#### PHOTOMETRIC DATA (MEASURED):

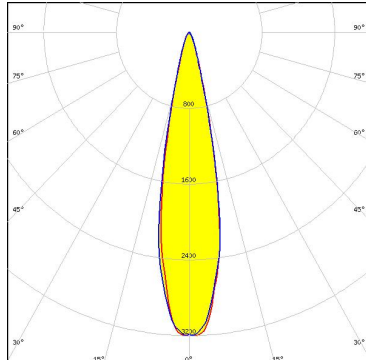
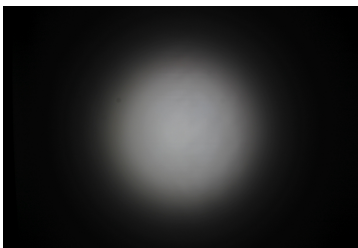
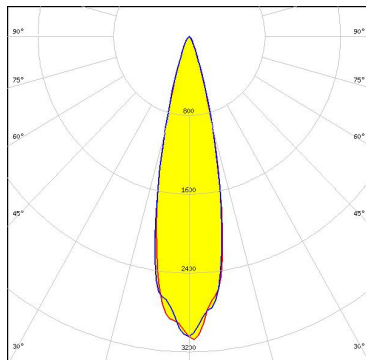
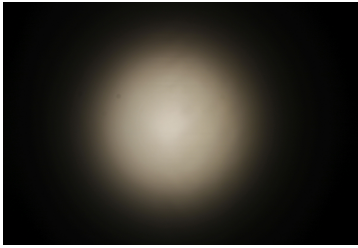
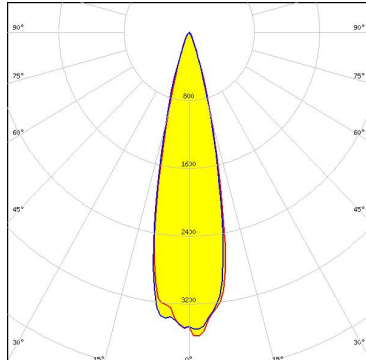
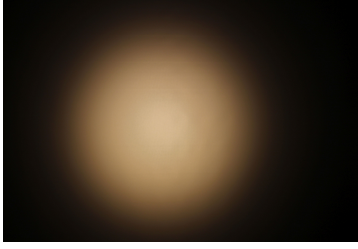
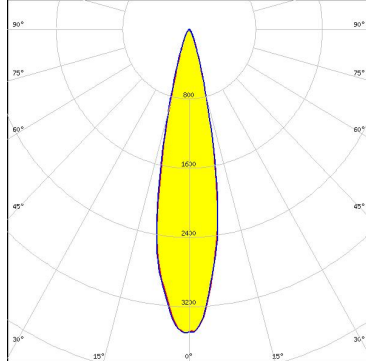
<p>bridgelux</p> <p>LED Vesta TW 9mm (9W) DP            FWHM 22.0°            Efficiency 55 %            Peak intensity 3.2 cd/lm            LEDs/each optic 1            Light colour White            Required components:            C16142_HEKLA-SOCKET-K            Bender Wirth: 489 Typ L8</p>		
<p><b>CITIZEN</b></p> <p>LED CLL02x/CLU02x (LES10)            FWHM 24.0°            Efficiency 66 %            Peak intensity 3.1 cd/lm            LEDs/each optic 1            Light colour White            Required components:            F15255_HEKLA-SOCKET-C</p>		
<p><b>CITIZEN</b></p> <p>LED CLU700/701/702            FWHM 19.0°            Efficiency 73 %            Peak intensity 5.3 cd/lm            LEDs/each optic 1            Light colour White            Required components:            F15255_HEKLA-SOCKET-C</p>		
<p><b>CITIZEN</b></p> <p>LED CLU710/711            FWHM 22.0°            Efficiency 65 %            Peak intensity 3.5 cd/lm            LEDs/each optic 1            Light colour White            Required components:            F15859_HEKLA-SOCKET-I</p>		



#### PHOTOMETRIC DATA (MEASURED):

**CREE** 

LED CMA1516  
 FWHM 25.0°  
 Efficiency 68 %  
 Peak intensity 3 cd/lm  
 LEDs/each optic 1  
 Light colour White  
 Required components:  
 F15256\_HEKLA-SOCKET-D

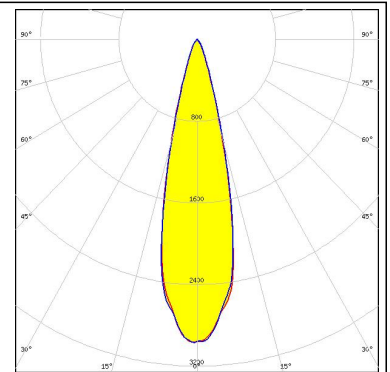

**CREE** 

LED CMT14xx  
 FWHM 25.0°  
 Efficiency 44 %  
 Peak intensity 1.9 cd/lm  
 LEDs/each optic 1  
 Light colour White  
 Required components:  
 F15255\_HEKLA-SOCKET-C

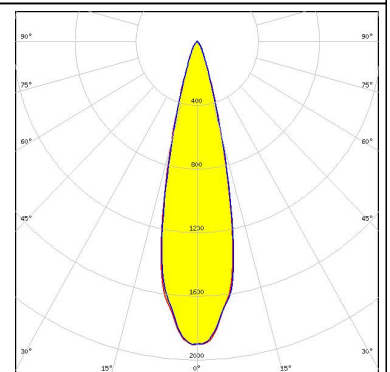
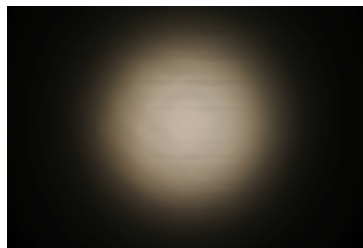

**CREE** 

LED CXA/B 13xx  
 FWHM 22.0°  
 Efficiency 77 %  
 Peak intensity 4.5 cd/lm  
 LEDs/each optic 1  
 Light colour White  
 Required components:  
 F15956\_HEKLA-SOCKET-J

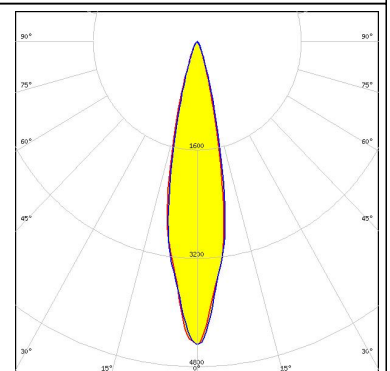
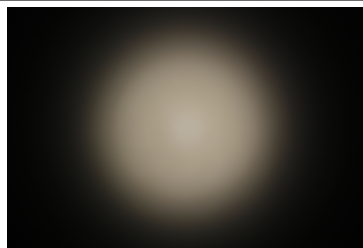

**CREE** 

LED CXA/B 13xx  
 FWHM 21.0°  
 Efficiency 76 %  
 Peak intensity 4.5 cd/lm  
 LEDs/each optic 1  
 Light colour White  
 Required components:  
 F15956\_HEKLA-SOCKET-J

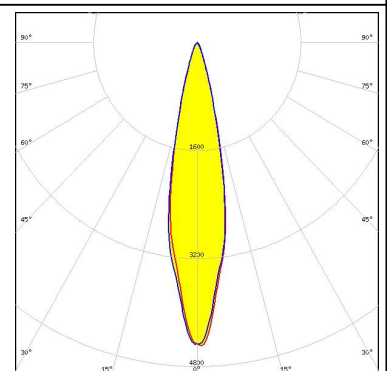
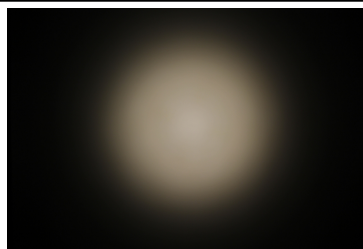

#### PHOTOMETRIC DATA (MEASURED):



LED CXA/B 15xx  
 FWHM 24.0°  
 Efficiency 69 %  
 Peak intensity 3.4 cd/lm  
 LEDs/each optic 1  
 Light colour White  
 Required components:  
 F15256\_HEKLA-SOCKET-D

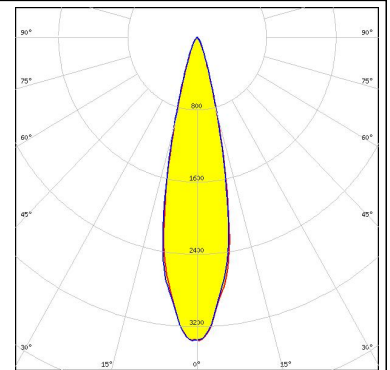

LED LUXEON CoB 1202HD  
 FWHM 21.0°  
 Efficiency 73 %  
 Peak intensity 4.4 cd/lm  
 LEDs/each optic 1  
 Light colour White  
 Required components:  
 F15848\_HEKLA-SOCKET-G

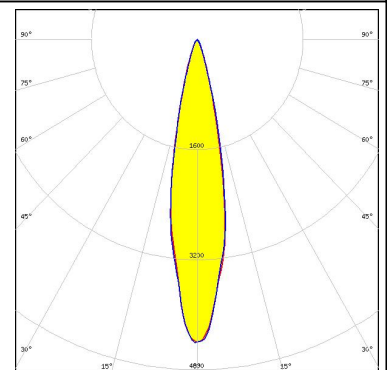
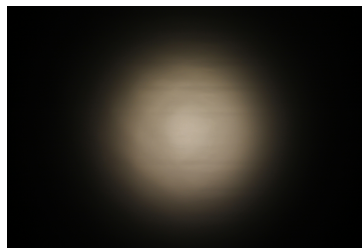

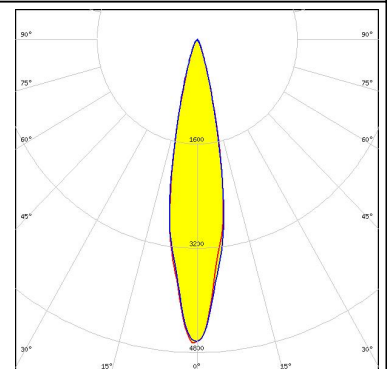
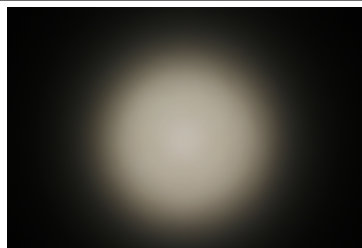

LED LUXEON CoB 1202s  
 FWHM 21.0°  
 Efficiency 75 %  
 Peak intensity 4.7 cd/lm  
 LEDs/each optic 1  
 Light colour White  
 Required components:  
 F15848\_HEKLA-SOCKET-G



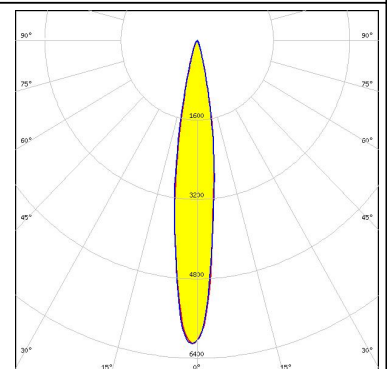

LED LUXEON CX Plus CoB - HD S01H4  
 FWHM 16.0°  
 Efficiency 68 %  
 Peak intensity 6.1 cd/lm  
 LEDs/each optic 1  
 Light colour White  
 Required components:  
 Bender Wirth: 634c Hekla

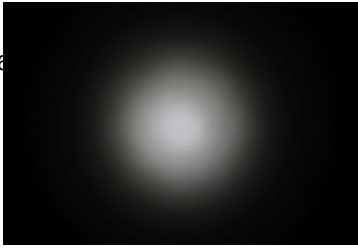
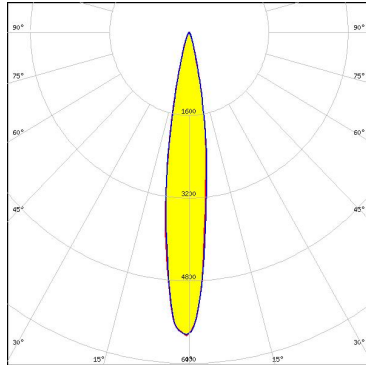
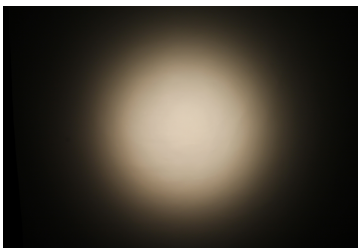
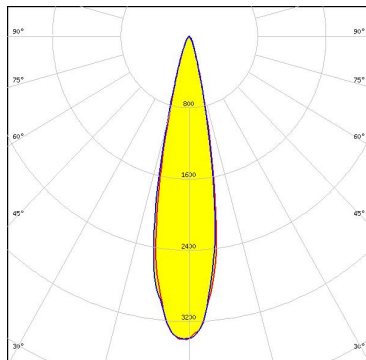
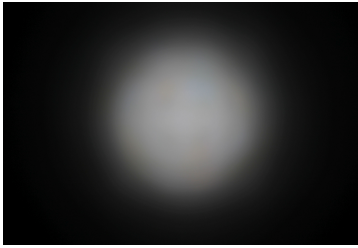
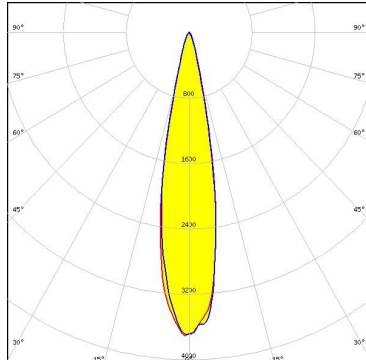

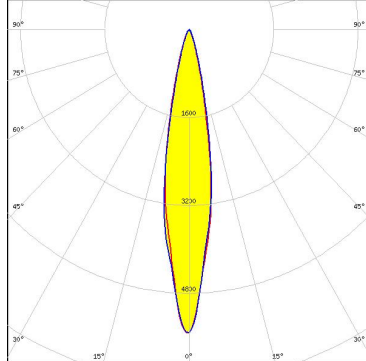
#### PHOTOMETRIC DATA (MEASURED):

<p><b>LUMILEDS</b></p> <p>LED LUXEON CX Plus CoB - HD S01H6 / HD S02H6</p> <p>FWHM 16.0°</p> <p>Efficiency 67 %</p> <p>Peak intensity 5.9 cd/lm</p> <p>LEDs/each optic 1</p> <p>Light colour White</p> <p>Required components: Bender Wirth: 634c Hekla</p>		
<p><b>LUMILEDS</b></p> <p>LED LUXEON CX Plus CoB - HD S04H9</p> <p>FWHM 22.0°</p> <p>Efficiency 61 %</p> <p>Peak intensity 3.4 cd/lm</p> <p>LEDs/each optic 1</p> <p>Light colour White</p> <p>Required components: Bender Wirth: 634c Hekla</p>		
<p><b>LUMINUS</b></p> <p>LED CDM-9 (Dim-To-Warm)</p> <p>FWHM 21.0°</p> <p>Efficiency 57 %</p> <p>Peak intensity 3.7 cd/lm</p> <p>LEDs/each optic 1</p> <p>Light colour White</p> <p>Required components: C16142_HEKLA-SOCKET-K Bender Wirth: 490 Typ L8</p>		
<p><b>LUMINUS</b></p> <p>LED CXM-4</p> <p>FWHM 18.0°</p> <p>Efficiency 76 %</p> <p>Peak intensity 5.5 cd/lm</p> <p>LEDs/each optic 1</p> <p>Light colour White</p> <p>Required components: F15255_HEKLA-SOCKET-C</p>		

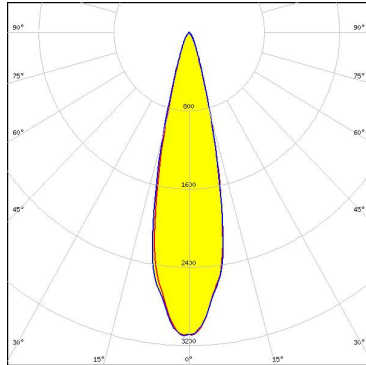
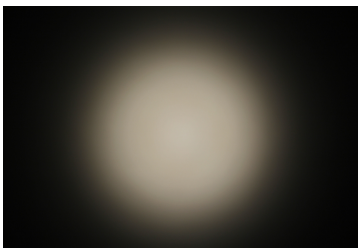
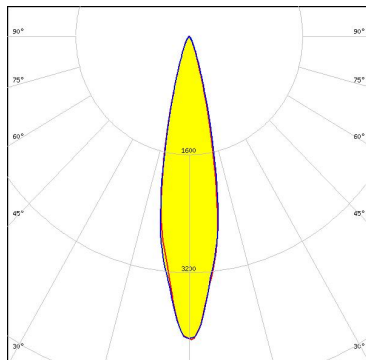
#### PHOTOMETRIC DATA (MEASURED):

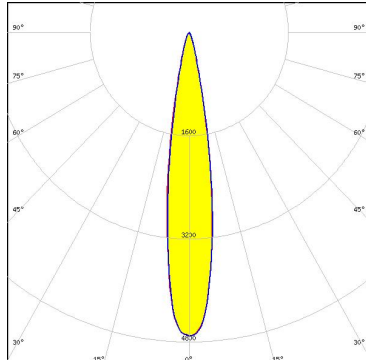
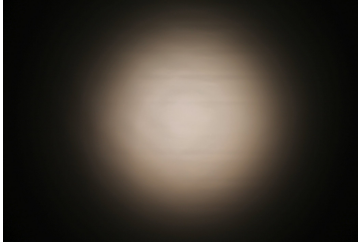
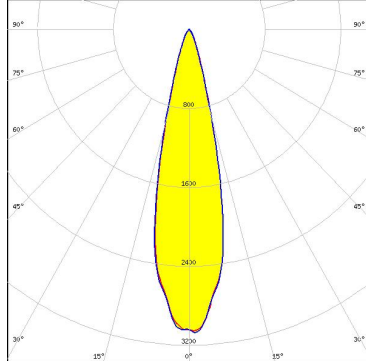
<p><b>LUMINUS</b></p> <p>LED CxM-9 (13.5x13.5)            FWHM 24.0°            Efficiency 67 %            Peak intensity 3.1 cd/lm            LEDs/each optic 1            Light colour White            Required components:            F15255_HEKLA-SOCKET-C</p>		
<p><b>NICHIA</b></p> <p>LED COB S-Type (LES 7)            FWHM 22.0°            Efficiency 73 %            Peak intensity 4.1 cd/lm            LEDs/each optic 1            Light colour White            Required components:            F15848_HEKLA-SOCKET-G</p>		
<p><b>NICHIA</b></p> <p>LED NJCWL024Z-V1MT: COB L-Type Tunable White            FWHM 17.0°            Efficiency 56 %            Peak intensity 4.7 cd/lm            LEDs/each optic 1            Light colour White            Required components:            C16142_HEKLA-SOCKET-K            Bender Wirth: 497 Typ L8</p>		
<p><b>PHILIPS</b></p> <p>LED Fortimo SLM L09 CoB            FWHM 24.0°            Efficiency 65 %            Peak intensity 3.1 cd/lm            LEDs/each optic 1            Light colour White            Required components:            F15858_HEKLA-SOCKET-H</p>		



#### PHOTOMETRIC DATA (MEASURED):

#### SAMSUNG

LED LC003D / LC006D / LC009D / LC013D  
 FWHM 25.0°  
 Efficiency 67 %  
 Peak intensity 3 cd/lm  
 LEDs/each optic 1  
 Light colour White  
 Required components:  
 F15255\_HEKLA-SOCKET-C

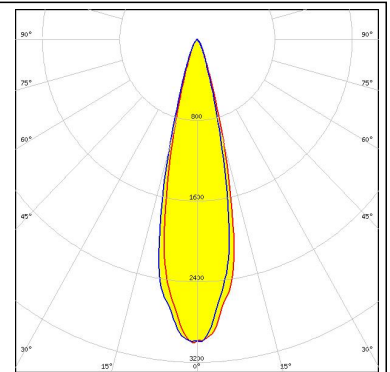
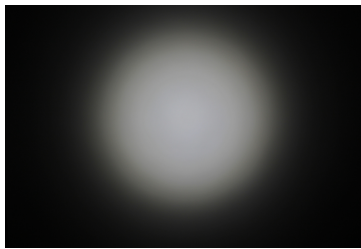

#### SAMSUNG

LED LC010C G2  
 FWHM 19.0°  
 Efficiency 74 %  
 Peak intensity 5.3 cd/lm  
 LEDs/each optic 1  
 Light colour White  
 Required components:  
 F15255\_HEKLA-SOCKET-C

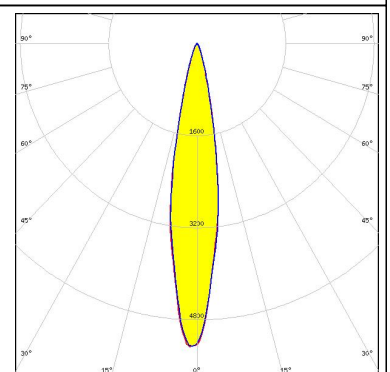
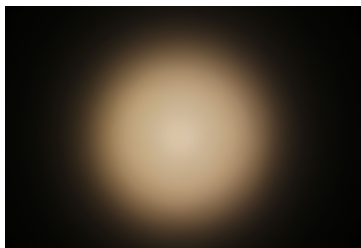

#### SAMSUNG

LED LC020C G2  
 FWHM 23.0°  
 Efficiency 65 %  
 Peak intensity 3.3 cd/lm  
 LEDs/each optic 1  
 Light colour White  
 Required components:  
 F15859\_HEKLA-SOCKET-I

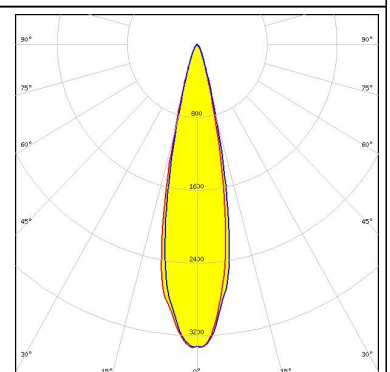
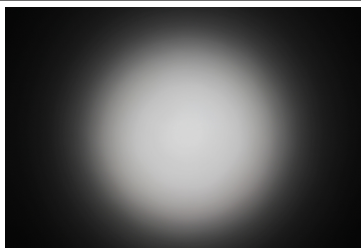

#### TRIDONIC

LED SLE G7 LES09  
 FWHM 23.0°  
 Efficiency 69 %  
 Peak intensity 3.5 cd/lm  
 LEDs/each optic 1  
 Light colour White  
 Required components:  
 F15255\_HEKLA-SOCKET-C

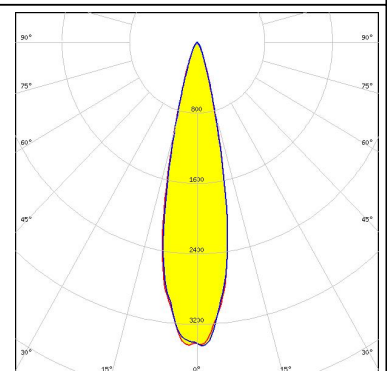
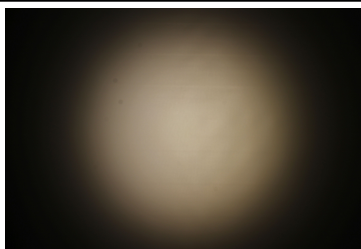

#### PHOTOMETRIC DATA (MEASURED):

#### TRIDONIC

LED SLE G7 LES13  
 FWHM 31.0°  
 Efficiency 58 %  
 Peak intensity 1.8 cd/lm  
 LEDs/each optic 1  
 Light colour White  
 Required components:  
 F15859\_HEKLA-SOCKET-I

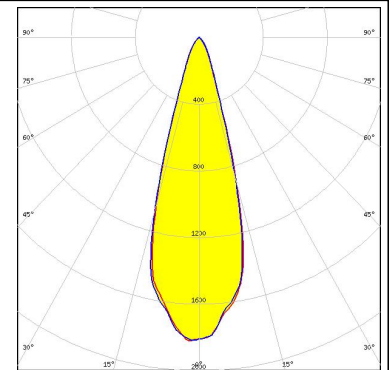

#### XICATO

LED XOB 6 mm  
 FWHM 19.0°  
 Efficiency 73 %  
 Peak intensity 4.9 cd/lm  
 LEDs/each optic 1  
 Light colour White  
 Required components:  
 F15255\_HEKLA-SOCKET-C

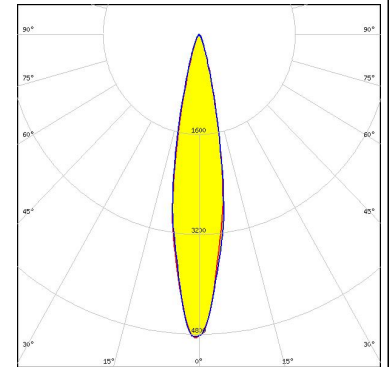
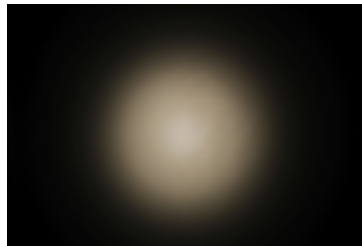

#### XICATO

LED XOB 9.8 mm  
 FWHM 24.0°  
 Efficiency 67 %  
 Peak intensity 3.2 cd/lm  
 LEDs/each optic 1  
 Light colour White  
 Required components:  
 F15255\_HEKLA-SOCKET-C

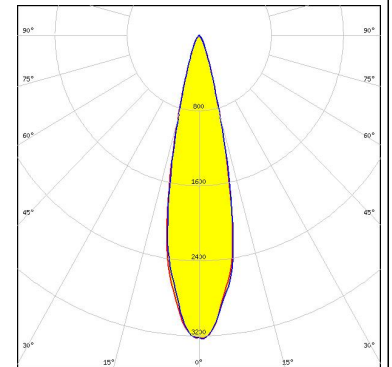



#### PHOTOMETRIC DATA (SIMULATED):

<p>bridgelux.</p> <p>LED V10 Gen7            FWHM 24.0°            Efficiency 65 %            Peak intensity 3.1 cd/lm            LEDs/each optic 1            Light colour White            Required components:            F15255_HEKLA-SOCKET-C</p>	
<p>bridgelux.</p> <p>LED V6 Gen6            FWHM 21.0°            Efficiency 71 %            Peak intensity 4.4 cd/lm            LEDs/each optic 1            Light colour White            Required components:            F15253_HEKLA-SOCKET-A</p>	
<p>bridgelux.</p> <p>LED V8 Gen7            FWHM 24.0°            Efficiency 71 %            Peak intensity 3.7 cd/lm            LEDs/each optic 1            Light colour White            Required components:            F15253_HEKLA-SOCKET-A</p>	
<p>bridgelux.</p> <p>LED VERO10            FWHM 24.0°            Efficiency 64 %            Peak intensity 3.2 cd/lm            LEDs/each optic 1            Light colour White            Required components:            F15616_HEKLA-SOCKET-F</p>	

#### PHOTOMETRIC DATA (SIMULATED):



LED VERO13  
FWHM 27.0°  
Efficiency 66 %  
Peak intensity 2.5 cd/lm  
LEDs/each optic 1  
Light colour White  
Required components:  
C16142\_HEKLA-SOCKET-K

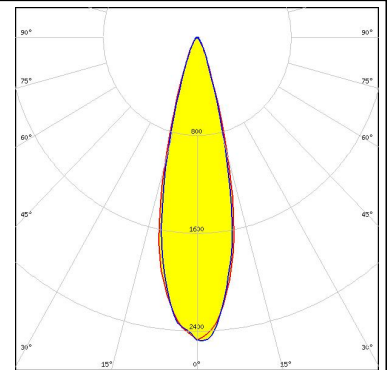

LED COB S-Type (LES 6)  
FWHM 30.0°  
Efficiency 62 %  
Peak intensity 2.1 cd/lm  
LEDs/each optic 1  
Light colour White  
Required components:  
F15848\_HEKLA-SOCKET-G

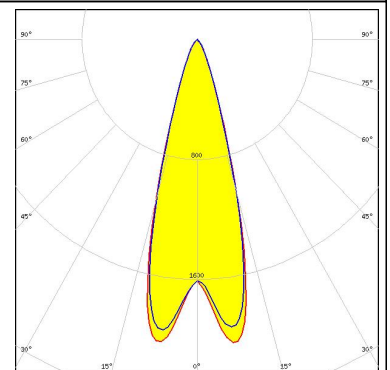

## SAMSUNG

LED LH231B  
FWHM 23.0°  
Efficiency 63 %  
Peak intensity 3 cd/lm  
LEDs/each optic 7  
Light colour White  
Required components:  
F15255\_HEKLA-SOCKET-C

## XICATO

LED XTM - 9mm LES  
FWHM 25.0°  
Efficiency 67 %  
Peak intensity 3 cd/lm  
LEDs/each optic 1  
Light colour White  
Required components:  
C15743\_XTM-ADAPTER-50-B

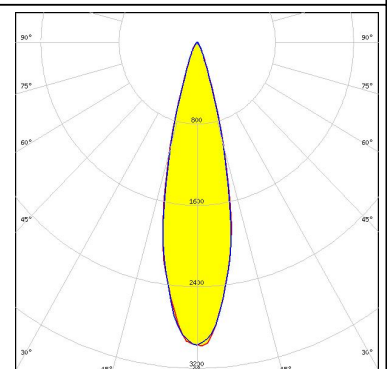

### GENERAL INFORMATION:

NOTE: The typical beam angle will be changed by different color, chip size and chip position tolerance. The typical total beam angle is the full angle measured where the luminous intensity is half of the peak value.

Due to use of high power COB's with this product, special attention to proper thermal design is highly recommended. LEDiL has no liability for direct, indirect or consecutive damages arising from the LEDiL products being used outside of the recommended temperature range.

### MATERIALS:

As part of our continuous research and improvement processes, and to ensure the best possible quality and availability of our products, LEDiL reserves the right to change material grades without notice.

### PRODUCT DATA USER AGREEMENT AND DISCLAIMER:

The measured data in the provided downloadable LEDiL Product Datasheets and Mechanical 2D-Drawings is rounded and provided as reference for planning. LEDiL Oy's optical specifications have been verified by conducting performance testing of the products in accordance with the company's quality system. The reported data are averaged results of multiple measurements with typical variation. LEDiL Oy reserves the right to without prior notification make changes and improvements to its products.

LEDiL Oy assumes neither warranty, nor guarantee nor any other liability of any kind for the contents and correctness of the provided data. The provided data has been generated with highest diligence but the provided data may in reality not represent the complete possible variation range of all intrinsic parameters. Therefore, in certain cases a deviation from the provided data could occur.

LEDiL Oy reserves the right to undertake technical changes of its products without further notification which could lead to changes in the provided data. LEDiL Oy assumes no liability of any kind for the possible deviation from any provided data or any other damage resulting from the usage of the provided data.

The user agrees to this disclaimer and user agreement with the download or usage of the provided files.

#### LEDiL Oy

Joensuunkatu 13  
FI-24240 SALO  
Finland

#### LEDiL Inc.

228 West Page Street  
Suite D  
Sycamore IL 60178  
USA

#### Local sales and technical support

[www.ledil.com/where\\_to\\_buy](http://www.ledil.com/where_to_buy)

#### Shipping locations

Salo, Finland  
Hong Kong, China

#### Distribution Partners

[www.ledil.com/where\\_to\\_buy](http://www.ledil.com/where_to_buy)



Компания «ЭлектроПласт» предлагает заключение долгосрочных отношений при поставках импортных электронных компонентов на взаимовыгодных условиях!

Наши преимущества:

- Оперативные поставки широкого спектра электронных компонентов отечественного и импортного производства напрямую от производителей и с крупнейших мировых складов;
- Поставка более 17-ти миллионов наименований электронных компонентов;
- Поставка сложных, дефицитных, либо снятых с производства позиций;
- Оперативные сроки поставки под заказ (от 5 рабочих дней);
- Экспресс доставка в любую точку России;
- Техническая поддержка проекта, помощь в подборе аналогов, поставка прототипов;
- Система менеджмента качества сертифицирована по Международному стандарту ISO 9001;
- Лицензия ФСБ на осуществление работ с использованием сведений, составляющих государственную тайну;
- Поставка специализированных компонентов (Xilinx, Altera, Analog Devices, Intersil, Interpoint, Microsemi, Aeroflex, Peregrine, Syfer, Eurofarad, Texas Instrument, Miteq, Cobham, E2V, MA-COM, Hittite, Mini-Circuits, General Dynamics и др.);

Помимо этого, одним из направлений компании «ЭлектроПласт» является направление «Источники питания». Мы предлагаем Вам помощь Конструкторского отдела:

- Подбор оптимального решения, техническое обоснование при выборе компонента;
- Подбор аналогов;
- Консультации по применению компонента;
- Поставка образцов и прототипов;
- Техническая поддержка проекта;
- Защита от снятия компонента с производства.



#### Как с нами связаться

**Телефон:** 8 (812) 309 58 32 (многоканальный)

**Факс:** 8 (812) 320-02-42

**Электронная почта:** [org@eplast1.ru](mailto:org@eplast1.ru)

**Адрес:** 198099, г. Санкт-Петербург, ул. Калинина, дом 2, корпус 4, литера А.