

Sealed Subminiature Snap Action Switch D2HW

Smallest Sealed Snap-Action Switch in the Industry With a Long Stroke For Reliable ON/OFF Action

- Conforms to IP67
- Case dimensions 22% smaller than conventional models
- Extra-long stroke even without levers (OT: 1.4 mm)
- All models are lead-free, including lead wire models
- RoHS Compliant



Ordering Information

Add "S" to the end of the model number for the UL/CSA-approved version. Consult your OMRON sales representative for details.

■ PCB-Mounted Models

| Actuator | Terminals | | Contact form | Model | | |
|---|-----------|----------|--------------|---|--|-------------------|
| | | | | With posts on right | With posts on left | Without posts |
| Pin plunger  | For PCB | Straight | SPDT |  |  | D2HW-A201D |
| | | Angled | | D2HW-BR201DR | D2HW-BL201DL | --- |
| Hinge lever  | | Straight | | --- | --- | D2HW-A211D |
| | | Angled | | D2HW-BR211DR | D2HW-BL211DL | --- |
| Long hinge lever  | | Straight | | --- | --- | D2HW-A221D |
| | | Angled | | D2HW-BR221DR | D2HW-BL221DL | --- |
| Simulated roller lever  | | Straight | | --- | --- | D2HW-A231D |
| | | Angled | | D2HW-BR231DR | D2HW-BL231DL | --- |

■ Models with Solder Terminals or Lead Wire Terminals

| Actuator | Terminals | | Contact form | Model | | |
|--|-----------|-----------|--------------|--|---|-------------------|
| | | | | With posts on right | With posts on left | M3-screw mounting |
| Pin plunger  | Solder | Downwards | SPDT |  |  | D2HW-C201H |
| | Lead wire | | SPDT | D2HW-BR201M | D2HW-BL201M | D2HW-C201M |
| | | | SPST-NC | D2HW-BR202M | D2HW-BL202M | D2HW-C202M |
| | | | SPST-NO | D2HW-BR203M | D2HW-BL203M | D2HW-C203M |





(This table continues on the next page.)

| Actuator | Terminals | | Contact form | Model | | |
|--|-----------|------------|--------------|--|---|--|
| | | | | With posts on right  | With posts on left  | M3-screw mounting  |
| Pin plunger  | Lead wire | Right-side | SPST-NC | D2HW-BR202MR | D2HW-BL202MR | D2HW-C202MR |
| | | | SPST-NO | D2HW-BR203MR | D2HW-BL203MR | D2HW-C203MR |
| | | Left-side | SPST-NC | D2HW-BR202ML | D2HW-BL202ML | — |
| | | | SPST-NO | D2HW-BR203ML | D2HW-BL203ML | — |
| Hinge lever  | Solder | | SPDT | D2HW-BR211H | D2HW-BL211H | D2HW-C211H |
| | Lead wire | Downwards | SPDT | D2HW-BR211M | D2HW-BL211M | D2HW-C211M |
| | | | SPST-NC | D2HW-BR212M | D2HW-BL212M | D2HW-C212M |
| | | | SPST-NO | D2HW-BR213M | D2HW-BL213M | D2HW-C213M |
| | | Right-side | SPST-NC | D2HW-BR212MR | D2HW-BL212MR | D2HW-C212MR |
| | | | SPST-NO | D2HW-BR213MR | D2HW-BL213MR | D2HW-C213MR |
| | | Left-side | SPST-NC | D2HW-BR212ML | D2HW-BL212ML | — |
| | SPST-NO | | D2HW-BR213ML | D2HW-BL213ML | — | |
| Long hinge lever  | Solder | | SPDT | D2HW-BR221H | D2HW-BL221H | D2HW-C221H |
| | Lead wire | Downwards | SPDT | D2HW-BR221M | D2HW-BL221M | D2HW-C221M |
| | | | SPST-NC | D2HW-BR222M | D2HW-BL222M | D2HW-C222M |
| | | | SPST-NO | D2HW-BR223M | D2HW-BL223M | D2HW-C223M |
| | | Right-side | SPST-NC | D2HW-BR222MR | D2HW-BL222MR | D2HW-C222MR |
| | | | SPST-NO | D2HW-BR223MR | D2HW-BL223MR | D2HW-C223MR |
| | | Left-side | SPST-NC | D2HW-BR222ML | D2HW-BL222ML | — |
| | SPST-NO | | D2HW-BR223ML | D2HW-BL223ML | — | |
| Simulated roller hinge lever  | Solder | | SPDT | D2HW-BR231H | D2HW-BL231H | D2HW-C231H |
| | Lead wire | Downwards | SPDT | D2HW-BR231M | D2HW-BL231M | D2HW-C231M |
| | | | SPST-NC | D2HW-BR232M | D2HW-BL232M | D2HW-C232M |
| | | | SPST-NO | D2HW-BR233M | D2HW-BL233M | D2HW-C233M |
| | | Right-side | SPST-NC | D2HW-BR232MR | D2HW-BL232MR | D2HW-C232MR |
| | | | SPST-NO | D2HW-BR233MR | D2HW-BL233MR | D2HW-C233MR |
| | | Left-side | SPST-NC | D2HW-BR232ML | D2HW-BL232ML | — |
| | SPST-NO | | D2HW-BR233ML | D2HW-BL233ML | — | |
| Hinge roller lever  | Solder | | SPDT | D2HW-BR241H | D2HW-BL241H | D2HW-C241H |
| | Lead wire | Downwards | SPDT | D2HW-BR241M | D2HW-BL241M | D2HW-C241M |
| | | | SPST-NC | D2HW-BR242M | D2HW-BL242M | D2HW-C242M |
| | | | SPST-NO | D2HW-BR243M | D2HW-BL243M | D2HW-C243M |
| | | Right-side | SPST-NC | D2HW-BR242MR | D2HW-BL242MR | D2HW-C242MR |
| | | | SPST-NO | D2HW-BR243MR | D2HW-BL243MR | D2HW-C243MR |
| | | Left-side | SPST-NC | D2HW-BR242ML | D2HW-BL242ML | --- |
| | SPST-NO | | D2HW-BR243ML | D2HW-BL243ML | --- | |
| Leaf lever  | Solder | | SPDT | D2HW-BR261H | D2HW-BL261H | D2HW-C261H |
| | Lead wire | Downwards | SPDT | D2HW-BR261M | D2HW-BL261M | D2HW-C261M |
| | | | SPST-NC | D2HW-BR262M | D2HW-BL262M | D2HW-C262M |
| | | | SPST-NO | D2HW-BR263M | D2HW-BL263M | D2HW-C263M |
| | | Right-side | SPST-NC | D2HW-BR262MR | D2HW-BL262MR | D2HW-C262MR |
| | | | SPST-NO | D2HW-BR263MR | D2HW-BL263MR | D2HW-C263MR |
| | | Left-side | SPST-NC | D2HW-BR262ML | D2HW-BL262ML | — |
| | SPST-NO | | D2HW-BR263ML | D2HW-BL263ML | — | |

Add "S" to the end of the model number for the UL/CSA-approved version. Consult your OMRON sales representative for details.

(This table continues on the next page.)

Ordering Information - continued from previous page

| Actuator | Terminals | | Contact form | Model | | |
|--|-----------|------------|--------------|---|---|--|
| | | | | With posts on right  | With posts on left  | M3-screw mounting  |
| Simulated roller leaf lever  | Solder | | SPDT | D2HW-BR271H | D2HW-BL271H | D2HW-C271H |
| | Lead wire | Downwards | SPDT | D2HW-BR271M | D2HW-BL271M | D2HW-C271M |
| | | | SPST-NC | D2HW-BR272M | D2HW-BL272M | D2HW-C272M |
| | | | SPST-NO | D2HW-BR273M | D2HW-BL273M | D2HW-C273M |
| | | Right-side | SPST-NC | D2HW-BR272MR | D2HW-BL272MR | D2HW-C272MR |
| | | | SPST-NO | D2HW-BR273MR | D2HW-BL273MR | D2HW-C273MR |
| | | Left-side | SPST-NC | D2HW-BR272ML | D2HW-BL272ML | — |
| | SPST-NO | | D2HW-BR273ML | D2HW-BL273ML | — | |
| Long leaf lever  | Lead wire | Downwards | SPDT | D2HW-BR281M | D2HW-BL281M | D2HW-C281M |
| | | | SPST-NC | D2HW-BR282M | D2HW-BL282M | D2HW-C282M |
| | | | SPST-NO | D2HW-BR283M | D2HW-BL283M | D2HW-C283M |
| | | Right-side | SPST-NC | — | — | D2HW-C282MR |
| | | | SPST-NO | — | — | D2HW-C283MR |

- Note:** 1. The length of standard lead wires (AVSS 0.5 = standard with UL1007 AWG 24 used on UL/CSA models.) for lead wire models is 30 cm (12 in).
 2. Add "S" to the end of the model number for the UL/CSA-approved version. Consult your OMRON sales representative for details.

Specifications

■ Characteristics

| Item | Specification |
|---|---|
| Operating speed | 1 mm to 500 mm/s (for pin plunger models) |
| Operating frequency | 30 operations/min. |
| Insulation resistance | 100 MΩ min. (at 500 VDC) |
| Contact resistance (initial value) | 100 mΩ max. (lead wire models: 150 mΩ max.) |
| Dielectric strength | 600 VAC, 50/60 Hz for 1 min. between terminals of the same polarity 1,500 VAC, 50/60 Hz for 1 min. between current-carrying metal parts and ground, and between each terminal and non-current-carrying metal parts |
| Vibration resistance (See note 2) | Malfunction: 10 to 55 Hz, 1.5-mm double amplitude |
| Shock resistance (See note 2) | Destruction: 1,000 m/s ² max. Malfunction: 300 m/s ² max. |
| Life expectancy (Consult Omron for test conditions) | Mechanical: 1,000,000 operations min. (30 operations/min.) Electrical: 100,000 operations min. (20 operations/min.) |
| Degree of protection | IP67 (excluding the terminals on terminal models) |
| Degree of protection against electric shock | Class I |
| Proof tracking index (PTI) | 175 |
| Ambient operating temperature | -40 to 85°C (with no icing) |
| Ambient operating humidity | 95% max. (in temperature range 5° to 35°C) |
| Weight | Approx. 0.7 g (for pin plunger models with terminals) |

- Note:** 1. The data given above are initial values.
 2. For the pin plunger models, the above values apply for use at the free position, operating position, and total travel position. For the lever models, they apply at the total travel position. The values shown apply for malfunctions of 1 ms max.

■ Ratings

| Rated voltage (V) | Resistive load |
|-------------------|----------------|
| 125 VAC | 0.1 A |
| 12 VDC | 2 A |
| 24 VDC | 1 A |
| 42 VDC | 0.5 A |

Note: The ratings apply under the following test conditions: Ambient Temperature = 20±2°C, Ambient Humidity = 65±5%, Operating frequency = 30 operations/min.

■ Contact Form

SPDT

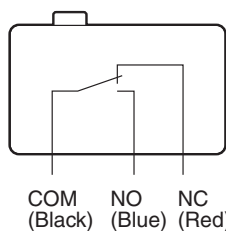

SPST-NC (Lead Wire Models Only)



SPST-NO (Lead Wire Models Only)

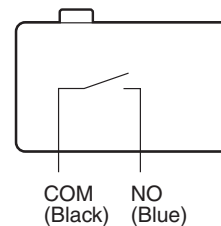

Note: Lead wire colors are indicated in parentheses.

■ Approved Standards

Consult your OMRON sales representative for specific models with standard approvals.

UL1054 (File No. E41515)/CSA C22.2 No. 55 (UL approval)

| Rated voltage | D2HW |
|---------------|-------|
| 125 VAC | 0.1 A |
| 12 VDC | 2 A |

■ Contact Specifications

| Item | Specification |
|------------------------------------|---------------|
| Specification | Crossbar |
| Material | Gold alloy |
| Gap (standard value) | 0.5 mm |
| Minimum applicable load (see note) | 1 mA at 5 VDC |

Note: Minimum applicable loads are indicated by N standard reference values. This value represents the failure rate at a 60% (λ_{60}) reliability level (JIS C5003).

The equation $\lambda_{60}=0.5 \times 10^{-6}/\text{operations}$ indicates that a failure rate of 1/2,000,000 operations can be expected at a reliability level of 60%.

Dimensions

Mounting Structure and Reference Positions for Operating Characteristics

- Note:** 1. All units are in millimeters unless otherwise indicated.
 2. Dimensions not indicated in the diagrams have a tolerance of ± 0.2 mm
 3. The reference positions used for FP, OP, and TTP values are as shown below for each type of mounting.

Models without Posts D2HW-A□



Models with Posts D2HW-B□



M3-screw Mounting Models D2HW-C□

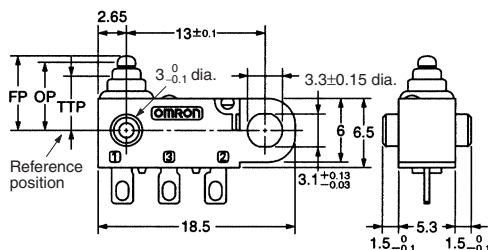

Mounting Hole Dimensions (Reference)

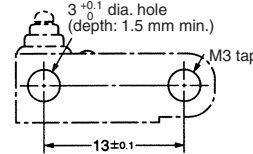
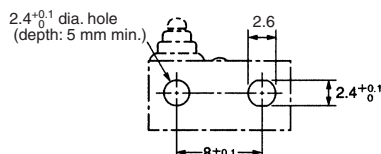

Terminals

Straight PCB Terminals



PCB Cutout Dimensions (Reference)

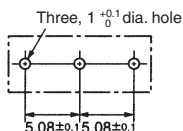

Angled PCB Terminals



PCB Cutout Dimensions (Reference)

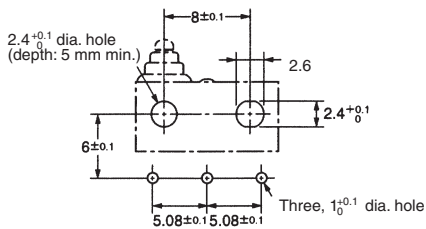

Solder Terminals

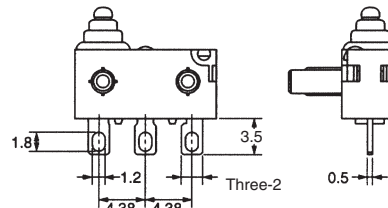

Lead Wires Downwards

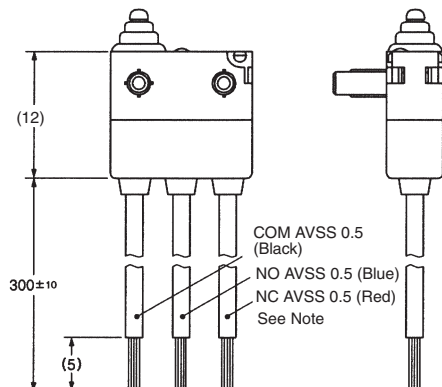

Lead Wires on Left-side



Lead Wires on Right-side



Note: UL1007 AWG24 wires are used for UL/CSA approved models.

Angled terminal directions are shown below.



■ Dimensions and Operating Characteristics

- Note:** 1. All units are in millimeters unless otherwise indicated.
 2. Dimensions not indicated in the diagrams below have a tolerance of ± 0.2 mm.
 3. The operating characteristics are for operation in the A direction (\downarrow).

Pin Plunger Models

D2HW-□20□□



| Characteristic | Models without posts | Models with posts and M3-mounting models |
|---------------------------|--|--|
| OF max. RF min. | 0.75 N {76 gf} 0.10 N {10 gf} | |
| OT ref. MD max. | 1.4 mm (reference value) 0.25 mm | |
| FP max. OP TTP max. | 11.2 mm 10.4 \pm 0.2 mm 9.1 mm | 7.2 mm 6.4 \pm 0.2 mm 5.1 mm |

Hinge Lever Models

D2HW-□21□□



| Characteristic | Models without posts | Models with posts and M3-mounting models |
|---------------------------|---------------------------------------|--|
| OF max. RF min. | 0.75 N {76 gf} 0.07 N {7 gf} | |
| OT ref. MD max. | 1.6 mm (reference value) 0.5 mm | |
| FP max. OP TTP max. | 12.8 mm 11.5 \pm 0.5 mm 10 mm | 8.8 mm 7.5 \pm 0.5 mm 6 mm |

Long Hinge Lever Models

D2HW-□22□□



| Characteristic | Models without posts | Models with posts and M3-mounting models |
|---------------------------|---------------------------------------|--|
| OF max. RF min. | 0.5 N {50 gf} 0.03 N {3 gf} | |
| OT ref. MD max. | 2.5 mm (reference value) 0.8 mm | |
| FP max. OP TTP max. | 15.5 mm 13.3 \pm 0.8 mm 11 mm | 11.5 mm 9.3 \pm 0.8 mm 7 mm |

Simulated Roller Hinge Lever Models

D2HW-□23□□



| Characteristic | Models without posts | Models with posts and M3-mounting models |
|---------------------------|---|--|
| OF max. RF min. | 0.65 N {66 gf} 0.05 N {5 gf} | |
| OT ref. MD max. | 1.9 mm (reference value) 0.5 mm | |
| FP max. OP TTP max. | 16.5 mm 15.2 \pm 0.5 mm 13.5 mm | 12.5 mm 11.2 \pm 0.5 mm 9.5 mm |

- Note:** 1. All units are in millimeters unless otherwise indicated.
 2. Dimensions not indicated in the diagrams below have a tolerance of ± 0.2 mm.
 3. The operating characteristics are for operation in the A direction (\downarrow).

Hinge Roller Lever Models

D2HW-□24□□

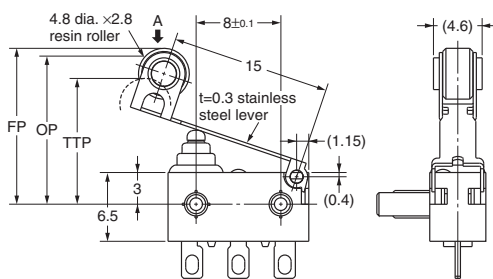

| Characteristic | Models with posts and M3-mounting models |
|---------------------------|--|
| OF max. RF min. | 0.65 N {66 gf} 0.03 N {3 gf} |
| OT ref. MD max. | 1.9 mm (reference value) 0.6 mm |
| FP max. OP TTP max. | 15.3 mm 14±0.6 mm 12.3 mm |

Leaf Lever Models

D2HW-□26□□

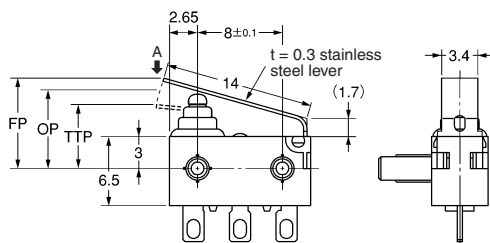

| Characteristic | Models with posts and M3-mounting models |
|---------------------------|--|
| OF max. RF min. | 1.8 N {183 gf} 0.20 N {20 gf} |
| OT ref. MD max. | 1.8 mm (reference value) 0.5 mm |
| FP max. OP TTP max. | 9.3 mm 7.4±0.5 mm 5.8 mm |

Simulated Roller Leaf Lever Models

D2HW-□27□□



| Characteristic | Models with posts and M3-mounting models |
|---------------------------|--|
| OF max. RF min. | 1.8 N {183 gf} 0.20 N {20 gf} |
| OT ref. MD max. | 2.0 mm (reference value) 0.5 mm |
| FP max. OP TTP max. | 12.5 mm 10.8±0.5 mm 8.9 mm |

Long Leaf Lever Models

D2HW-□28□□

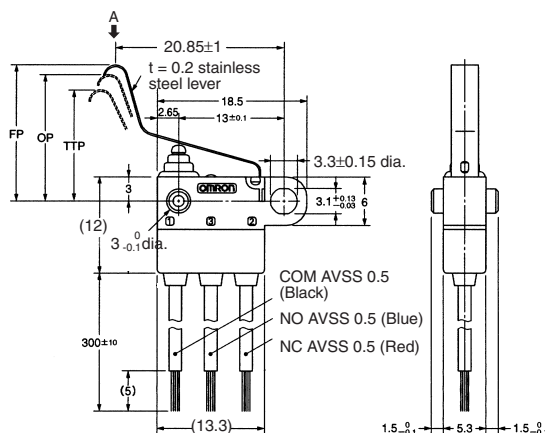

| Characteristic | Models with posts and M3-mounting models |
|---------------------------|--|
| OF max. RF min. | 0.9 N {92 gf} 0.05 N {5 gf} |
| OT ref. MD max. | 2.8 mm (reference value) 0.7 mm |
| FP max. OP TTP max. | 19 mm 15.4±1.5 mm 12.8 mm |

Note: UL1007 AWG24 wires are used for UL/CSA approved models.

Precautions

Be sure to read the precautions and information common to all Snap Action and Detection Switches, contained in the Technical User's Guide, "Snap Action Switches, Technical Information" for correct use.

■ Cautions

Degree of Protection

IEC Publication 529, degree of protection IP67.

Do not use this product in water. Although molded lead wire models satisfy the test conditions for the standard given below, this test is to check the ingress of water into the switch enclosure after submerging the Switch in water for a given time. Satisfying this test condition does not mean that the Switch can be used in water.

Do not operate the Switch when it is exposed to water spray, or when water drops adhere to the Switch surface, or during sudden temperature changes, otherwise water may intrude into the interior of the Switch due to a suction effect.

Prevent the Switch from coming into contact with oil and chemicals. Otherwise, damage to or deterioration of Switch materials may result.

Do not use the Switch in areas where it is exposed to silicon adhesives, oil, or grease, otherwise faulty contact may result due to the generation of silicon oxide.

Terminal Connection

When soldering the lead wire to the terminal, first insert the lead wire conductor through the terminal hole and then conduct soldering.

Made sure that the capacity of the soldering iron is 30 W maximum. Do not take more than 3 s to solder the switch terminal. Improper soldering involving an excessively high temperature or excessive soldering time may deteriorate the characteristics of the Switch.

When soldering the lead wire to the PCB terminal, pay careful attention so that the flux and solder liquid level does not exceed the PCB level.

Side-actuated (Cam/Dog) Operation

When using a cam or dog to operate the Switch, factors such as the operating speed, operating frequency, push-button indentation, and material and shape of the cam or dog will affect the durability of the Switch. Confirm performance specifications under actual operation conditions before using the Switch in applications.

IEC Publication 529, degree of protection IP67.



■ Correct Use

Mounting

Turn OFF the power supply before mounting or removing the Switch, wiring, or performing maintenance or inspection. Failure to do so may result in electric shock or burning.

For M3-screw mounting models, use M3 mounting screws with plane washers or spring washers to securely mount the Switch. Tighten the screws to a torque of 0.27 to 0.29 N·m. Exceeding the specified torque may result in deterioration of the sealing or damage.

For models with posts, secure the posts by thermal caulking or by pressing into an attached device. When pressed into an attached device, provide guides on the opposite ends of the posts to ensure that they do not fall out or rattle.

Mount the Switch onto a flat surface. Mounting on an uneven surface may cause deformation of the Switch, resulting in faulty operation or damage.

Operating Body

Use an operating body with low frictional resistance and of a shape that will not interfere with the sealing rubber, otherwise the plunger may be damaged or the sealing may deteriorate.

Handling

Do not handle the Switch in a way that may cause damage to the sealing rubber.

When handling the Switch, ensure that pressure is not applied to the posts in the directions shown in the following diagram. Also, ensure that uneven pressure or pressure in a direction other than the operating direction is not applied to the Actuator as shown in the following diagram. Otherwise, the post, Actuator, or Switch may be damaged, or the service life may be reduced.



Wiring Molded Lead Wire Models

When wiring molded lead wire models, ensure that there is no weight on the wire or that there are no sharp bends near the parts where the wire is drawn out. Otherwise, damage to the Switch or deterioration in the sealing may result.

Using Micro Loads

Even when using micro load models within the operating range, inrush currents or surges may decrease the life expectancy of the Switch. Therefore, insert a contact protection circuit where necessary.

A large grid of 20 columns and 30 rows of small squares, intended for taking notes. The grid is composed of thin, light gray lines forming a uniform pattern of small squares across the page.

All sales are subject to Omron Electronic Components LLC standard terms and conditions of sale, which can be found at http://www.components.omron.com/components/web/webfiles.nsf/sales_terms.html

ALL DIMENSIONS SHOWN ARE IN MILLIMETERS.
To convert millimeters into inches, multiply by 0.03937. To convert grams into ounces, multiply by 0.03527.

OMRON[®]

**OMRON ELECTRONIC
COMPONENTS LLC**

55 E. Commerce Drive, Suite B
Schaumburg, IL 60173

847-882-2288

OMRON ON-LINE

Global - <http://www.omron.com>

USA - <http://www.components.omron.com>



Компания «ЭлектроПласт» предлагает заключение долгосрочных отношений при поставках импортных электронных компонентов на взаимовыгодных условиях!

Наши преимущества:

- Оперативные поставки широкого спектра электронных компонентов отечественного и импортного производства напрямую от производителей и с крупнейших мировых складов;
- Поставка более 17-ти миллионов наименований электронных компонентов;
- Поставка сложных, дефицитных, либо снятых с производства позиций;
- Оперативные сроки поставки под заказ (от 5 рабочих дней);
- Экспресс доставка в любую точку России;
- Техническая поддержка проекта, помощь в подборе аналогов, поставка прототипов;
- Система менеджмента качества сертифицирована по Международному стандарту ISO 9001;
- Лицензия ФСБ на осуществление работ с использованием сведений, составляющих государственную тайну;
- Поставка специализированных компонентов (Xilinx, Altera, Analog Devices, Intersil, Interpoint, Microsemi, Aeroflex, Peregrine, Syfer, Eurofarad, Texas Instrument, Miteq, Cobham, E2V, MA-COM, Hittite, Mini-Circuits, General Dynamics и др.);

Помимо этого, одним из направлений компании «ЭлектроПласт» является направление «Источники питания». Мы предлагаем Вам помощь Конструкторского отдела:

- Подбор оптимального решения, техническое обоснование при выборе компонента;
- Подбор аналогов;
- Консультации по применению компонента;
- Поставка образцов и прототипов;
- Техническая поддержка проекта;
- Защита от снятия компонента с производства.



Как с нами связаться

Телефон: 8 (812) 309 58 32 (многоканальный)

Факс: 8 (812) 320-02-42

Электронная почта: org@eplast1.ru

Адрес: 198099, г. Санкт-Петербург, ул. Калинина, дом 2, корпус 4, литера А.